



OWNER'S MANUAL

MICROWAVE OVEN

Read this owner's manual thoroughly before operating the appliance and keep it handy for reference at all times.

UPMC3084ST



MFL68927904_01

www.thesignaturekitchen.com

***Thank you for purchasing a
SIGNATURE KITCHEN SUITE microwave oven.***

Please record the model number and serial number of this unit for future reference. We also suggest you record the details of your contact with SIGNATURE KITCHEN SUITE concerning this unit.

Model No: _____

Serial No: _____

Dealer: _____

Dealer Phone No: _____

Staple your receipt here to prove your retail purchase.

Customer Relations
SIGNATURE KITCHEN SUITE U.S.A., Inc.
Service Division Bldg. #3
201 James Record Rd.
Huntsville, AL 35824-0126

**PRECAUTIONS TO AVOID POSSIBLE
EXPOSURE TO EXCESSIVE
MICROWAVE ENERGY...**

- (a) Do not attempt to operate this oven with the door open since open-door operation can result in harmful exposure to microwave energy. It is important not to defeat or tamper with the safety interlocks.
- (b) Do not place any object between the oven front face and the door or allow soil or cleaner residue to accumulate on sealing surfaces.
- (c) Do not operate the oven if it is damaged.
It is particularly important that the oven door closes properly and that there is no damage to the:
 - (1) door (bent),
 - (2) hinges and latches (broken or loosened),
 - (3) door seals and sealing surfaces.
- (d) The oven should not be adjusted or repaired by anyone except properly qualified service personnel.

TABLE OF CONTENTS

4 IMPORTANT SAFETY INSTRUCTIONS

7 PRODUCT OVERVIEW

- 7 Location of Model Number
- 7 Electrical Requirements
- 7 Grounding Instructions
- 7 Oven Specifications
- 8 Microwave Oven Features
- 8 Accessories
- 9 Control Panel Overview

11 MICROWAVE COOKING TIPS

16 OPERATION

- 16 Using the Microwave Oven
- 16 Clock
- 16 Child Lock
- 16 Timer
- 17 Custom Cook
- 17 Vent Fan
- 17 Vent Fan Auto Timeset
- 18 Turntable On/Off
- 18 Light On/Off
- 18 Cooking at High Power Level
- 18 Custom Set
- 19 Cooking at Lower Power Levels
- 19 Cooking with More than One Cook Cycle
- 20 Cooking Guide for Lower Power Levels
- 21 Sensor Operating Instructions
- 21 Sensor Cooking Guide
- 21 Sensor Reheat
- 21 Sensor Cook
- 21 Sensor Popcorn
- 22 Sensor Reheat Table
- 22 Sensor Cook Table
- 23 Tips for Convection Cooking
- 24 Convection
- 25 Tips for Combination Cooking
- 25 Helpful Hints for Combination Cooking
- 25 Combination Roast
- 26 Auto Cook
- 26 Auto Cook Table
- 27 Soften
- 27 Soften Table

- 27 Melt
- 27 Melt Table
- 28 Speed Auto Combination
- 28 Speed Auto Combination Chart
- 29 Auto Defrost
- 29 Weight Conversion Table
- 29 Operating Tips
- 30 Auto Defrost Table
- 32 Defrosting Tips

33 COOKING GUIDE

- 33 Convection Baking Guidelines
- 35 Meat Roasting Guidelines for Convection Cooking
- 36 Combination Roast Cooking Guide
- 37 Combination Bake Cooking Guide
- 38 Heating/Reheating Guide
- 39 Fresh Vegetable Guide

40 SMART FUNCTIONS

- 40 Application Installation
- 40 Product Registration
- 40 Using the Wi-Fi Function
- 41 FCC Notice (For transmitter module contained in this product)
- 41 FCC RF Radiation Exposure Statement

42 SMART DIAGNOSIS™

- 42 Using Smart Diagnosis™

43 MAINTENANCE

- 43 Caring for the Microwave Oven
- 44 Cleaning the Grease Filters
- 44 Charcoal Filter Replacement
- 45 Oven Light Replacement
- 45 Cooktop/Countertop Light Replacement
- 46 Microwave Utensil Guide

47 TROUBLESHOOTING

- 47 Frequently Asked Questions
- 48 Before Calling for Service

49 WARRANTY

IMPORTANT SAFETY INSTRUCTIONS

Read and follow all instructions when using the range to prevent the risk of fire, electric shock, personal injury, or damage. This guide does not cover all possible conditions that may occur. Always contact your service agent or manufacturer about problems that you do not understand.

Download this owner's manual at: www.thesignaturekitchen.com



This is the safety alert symbol. This symbol alerts you to potential hazards that can result in property damage and/or serious bodily harm or death.

All safety messages will follow the safety alert symbol and either the word **WARNING** or **CAUTION**. These words mean:



WARNING - Indicates a hazardous situation which, if not avoided, could result in death or serious injury.



CAUTION - Indicates a hazardous situation which, if not avoided, could result in minor or moderate injury.

The safety instructions below will tell you how to use your oven and avoid harm to yourself or damage to your oven.



WARNING

- **Read all the instructions before using your oven.**
- **As with any appliance, close supervision is necessary when used by children.**
- Read and follow the specific **PRECAUTIONS TO AVOID POSSIBLE EXPOSURE TO EXCESSIVE MICROWAVE ENERGY** found on page 2.
- **Do not use** corrosive chemicals or vapors, such as sulfide and chloride, in this appliance. This type of oven is specifically designed to heat, cook, or dry food. It is not designed for industrial or laboratory use.
- **Do not store** this appliance outdoors. Do not use this product near water - for example, near a kitchen sink, in a wet basement, near a swimming pool, or similar location.
- **Do not use** the cavity for storage purposes. Do not leave paper products, cooking utensils, or food in the cavity when not in use.
- **Clean Ventilating Hoods Frequently – Grease should not be allowed to accumulate on hood or filter.**
- Use care when cleaning the vent hood filters. Corrosive cleaning agents, such as lye-based oven cleaners, may damage the filters.
- **Do not tamper with the built-in safety switches on the oven door.** The oven has several built-in safety switches to make sure the power is off when the door is open.
- When flaming foods under the hood, turn the fan on.
- Suitable for use above both gas and electric cooking equipment 36 inches wide or less.
- **Do not use this oven for commercial purposes.** It is made for household use only.
- **When cleaning surfaces of door and oven that come together on closing the door, use only mild, nonabrasive soaps, or detergents applied with a sponge or soft cloth.**
- **If your oven is dropped or damaged,** have it thoroughly checked by a qualified service technician before using it again.

 **WARNING**

- **To reduce the risk of fire in the oven cavity:**
 - **Do not overcook food.** Carefully attend to the microwave oven when paper, plastic or other combustible materials are placed inside the oven to facilitate cooking.
 - **Do not use the cavity for storage purposes.**
Do not leave paper products, cooking utensils or food in the cavity when not in use.
 - Remove wire twist-ties from paper or plastic bags before placing bags in oven.
- **If materials inside the oven ignite:**
 - **Keep oven door closed**
 - **Turn the oven off**
 - **Disconnect the power cord or shut off power at the fuse or circuit breaker panel**
- **To avoid electric shock:**
 - **This appliance must be grounded.** Connect only to a properly grounded outlet. See the electrical **GROUNDING INSTRUCTIONS** on page 7.
 - **Do not operate this appliance if it has a damaged cord or plug**, if it is not working properly or if it has been damaged or dropped.
 - **Do not immerse the electrical cord or plug in water.**
 - **Keep cord away from heated surfaces.**
 - **Do not let cord hang over edge of table or counter.**
- **Take care when the door is opened to avoid injury.**
- **To avoid improperly cooking some foods.**
 - **Do not heat any types of baby bottles or baby food.** Uneven heating may occur and possibly cause personal injury.
 - **Do not heat small-necked containers**, such as syrup bottles.
 - **Do not deep-fat fry in your microwave oven.**
 - **Do not attempt home canning in your microwave oven.**
 - **Some products such as whole eggs and sealed containers – for example, closed glass jars – are able to explode and should not be heated in this oven.**
- Do not cover or block any openings on the appliance.
- Use this appliance only for its intended use as described in the manual.
- Do not run the oven empty.
- Secure power cord in the cabinet above the oven.
- **Preserve the oven floor:**
 - **Do not heat the oven floor excessively.**
 - **Do not** allow the gray film on special microwave-cooking packages to touch the oven floor. Put the package on a microwavable dish.
 - **Do not** cook anything directly on the oven floor or turntable. Use a microwavable dish.
 - Keep a browning dish at least 3/16 inch above floor. Carefully read and follow the instructions for the browning dish. If you use a browning dish incorrectly, you could damage the oven floor.
- Install or locate this appliance only in accordance with the provided installation instructions.
- This appliance should be serviced only by qualified service personnel. Contact the nearest authorized service facility for examination, repair, or adjustment.

 **WARNING**

- Liquids, such as water, coffee, or tea can be overheated beyond the boiling point without appearing to be boiling due to surface tension of the liquid. Visible bubbling or boiling when the container is removed from the microwave oven is not always present.

THIS COULD RESULT IN VERY HOT LIQUIDS SUDDENLY BOILING OVER WHEN THE CONTAINER IS DISTURBED OR A SPOON OR OTHER UTENSIL IS INSERTED INTO THE LIQUID.

- To reduce the risk of injury to persons;
 - Do not overheat the liquid.
 - Stir the liquid both before and halfway through heating it.
 - Do not use straight-sided containers with narrow necks.
 - After heating, allow the container to stand in the microwave oven for a short time before removing the container.
 - Use extreme care when inserting a spoon or other utensil into the container.

FEDERAL COMMUNICATIONS COMMISSION RADIO FREQUENCY INTERFERENCE STATEMENT (U.S.A. ONLY)

This equipment generates and uses ISM frequency energy and if not installed and used properly, that is in strict accordance with the manufacturer's instructions, may cause interference to radio and television reception. It has been type tested and found to comply with limits for ISM Equipment pursuant to part 18 of FCC Rules, which are designed to provide reasonable protection against such interference in a residential installation.

However, there is no guarantee that interference will not occur in a particular installation. If this equipment does cause interference to radio or television reception, which can be determined by turning the equipment off and on, the user is encouraged to try to correct the interference by one or more of the following:

- Reorient the receiving antenna of the radio or television.
- Relocate the Microwave Oven with respect to the receiver.
- Move the microwave oven away from the receiver.
- Plug the microwave oven into a different outlet so that the microwave oven and the receiver are on different branch circuits.

The manufacturer is not responsible for any radio or TV interference caused by unauthorized modification to this microwave oven. It is the responsibility of the user to correct such interference.

 **WARNING**

This product contains chemicals known to the State of California to cause cancer and birth defects or other reproductive harm. ***Wash hands after handling.***

**Read all instructions before using the appliance.
SAVE THESE INSTRUCTIONS**

PRODUCT OVERVIEW

Location of Model Number

To request service information or replacement parts, the service center requires the complete model number of your microwave oven. The model number is on the oven front as shown in the illustration below.

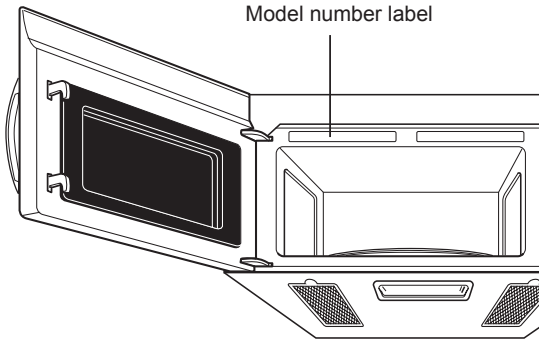

Electrical Requirements

The oven is designed to operate on a Standard 120 V/60 Hz household outlet. Be sure the circuit is at least 15 A or 20 A and the microwave oven is the only appliance on the circuit. It is not designed for 50 Hz or any circuit other than a 120 V/60 Hz circuit.

Grounding Instructions

This appliance must be grounded. In the event of an electrical short circuit, grounding reduces the risk of electric shock by providing an escape wire for the electric current. This appliance is equipped with a cord having a grounding wire with a grounding plug. The plug must be plugged into an outlet that is properly installed and grounded.

WARNING

- Improper use of the grounding can result in a risk of electric shock.

Consult a qualified electrician or service person if the grounding instructions are not completely understood, or if doubt exists as to whether the appliance is properly grounded.

Because this appliance fits under the cabinet, it has a short power-supply cord. Do not use an extension cord. If the power supply cord is too short, have a qualified electrician or service person install an outlet near the appliance. A short power supply cord is provided to reduce the risks resulting from becoming entangled in or tripping over a longer cord.

See the separate Installation Instructions for directions on placing the cord properly.

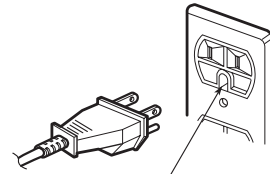

Ensure proper ground exists before use

Keep the electrical power cord dry and do not pinch or crush it in any way.

Oven Specifications

Power Supply		120 V AC, 60 Hz
Rated Current	Microwave	14.0 A
	Convection	14.0 A
Rated Power Input	Microwave	1650 W
	Convection	1650 W
Power Output	Microwave	950 W
Overall Dimensions(WxHxD)		29 15/16" x 16 7/16" x 15 3/8"
Oven Cavity Dimensions (WxHxD)		21 1/4" x 9 9/16" x 14 3/16"
Capacity of Oven Cavity		1.7 cu.ft

Microwave Oven Features

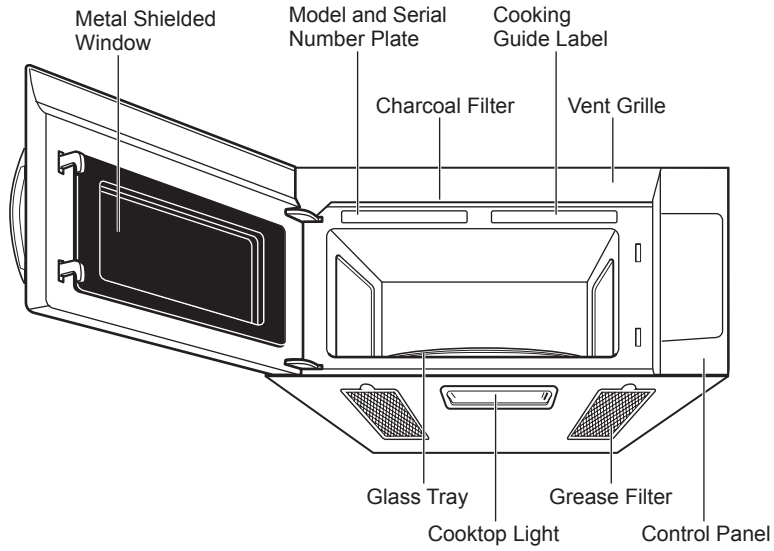

Accessories

The turntable rotates in both direction to help food cook more evenly. Do not operate the microwave oven without the glass tray in place.

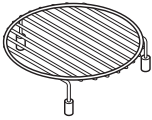

Convection Rack

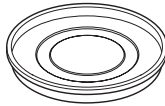

Metal Tray / Drip Pan

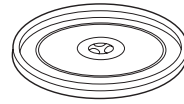

Glass Tray

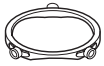

Rotating Ring



Shaft

Control Panel Overview

Use the control panel to select the desired cooking function quickly and easily. Simply touch a command key to select the desired function. **For more information on these features, see the OPERATION section.**

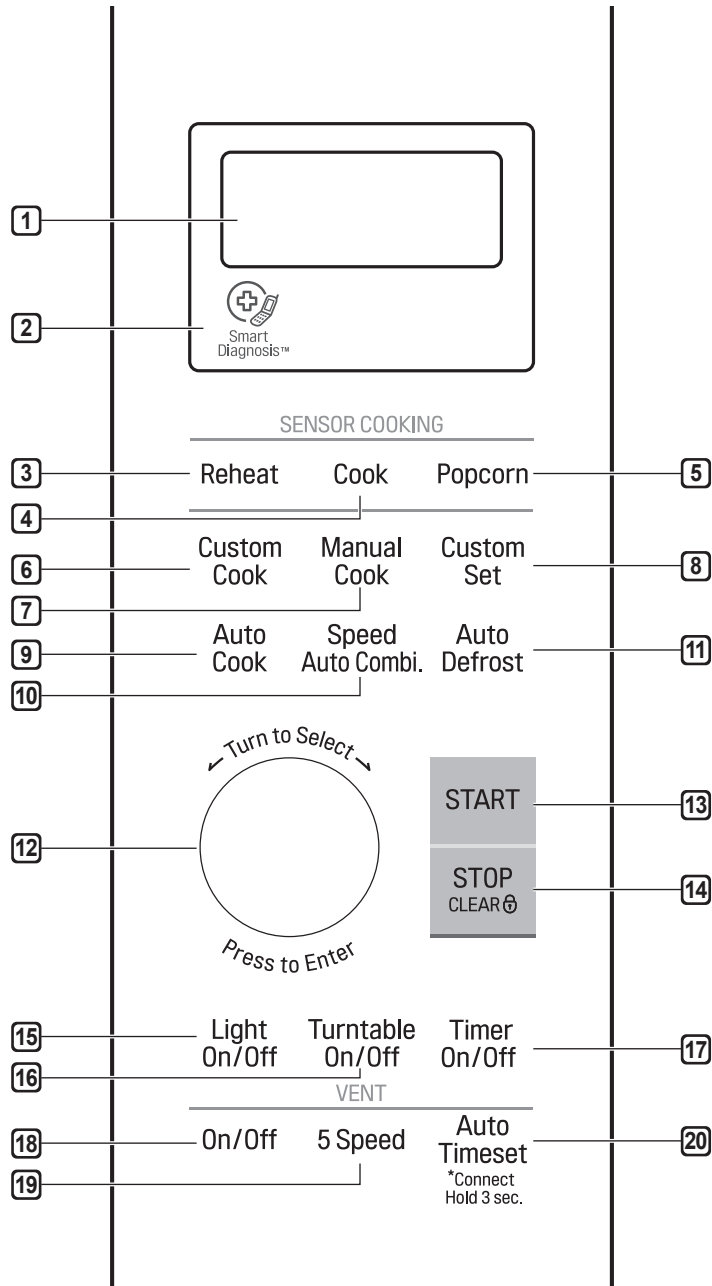

1 Display

The Display includes a clock and indicators to tell you time of day, cooking time settings, and cooking functions selected.

2 Smart Diagnosis

Hold the mouthpiece of a phone up to this icon when directed to by service center personnel, to help diagnose problems with the oven when calling for service.

3 Sensor Reheat

Touch this key to reheat casseroles, dinner plates, pizza slices, and soups/sauces. The oven's sensor tells the oven how long to cook depending on the amount of humidity coming from the food.

4 Sensor Cook

Touch this key to cook baked potatoes, frozen vegetables, fresh vegetables, canned vegetables, frozen entrées, and rice. The oven's sensor tells the oven how long to cook depending on the amount of humidity coming from the food.

5 Sensor Popcorn

Touch this to pop popcorn. The oven's sensor tells the oven how long to cook depending on the amount of humidity it detects from the popcorn.

6 Custom Cook

Touch this key to recall one cooking instruction previously programmed into memory.

7 Manual Cook

Select the functions to operate MICROWAVE and CONVECTION, COMBI.

8 Custom Set

Touch this key to change the oven's default settings for sound, clock, display speed, and defrost weight.

9 Auto Cook

Touch this key to cook bacon, fresh rolls and muffins, frozen rolls and muffins, beverages, chicken pieces, and hot cereal.

- SOFTEN: butter, ice cream, cream cheese, or frozen juice.
- MELT: butter, chocolate, cheese, or marshmallows.

10 Speed Auto Combi

Touch this key when setting weight combination cooking.

11 Auto Defrost

Touch this key to select food type and defrost food by weight.

12 Control Dial

Set cooking time, temperature, weight and cooking categories. Lengthen or shorten the cooking time at any point by turning the dial(except in defrost mode). Press on the dial to start a function or enter all entries.

13 START

Touch the key to start a function, accept selections, or restart after opening.

14 STOP/CLEAR

Touch this key to stop the oven or to clear all entries.

15 Light On/Off

Touch this key to turn the cooktop/countertop light on or off.

16 Turntable On/Off

Touch this key to turn off the turntable. OFF appears in the display.

NOTE

This option is not available in sensor cook and defrost modes.

17 Timer On/Off

Touch this key to set the timer.

18 Vent On/Off

Touch this key to turn the fan on/off.

19 VENT 5-SPEED

Touch this key to choose one of 5 fan speeds.

20 VENT AUTO TIMESET(*Connect Hold 3 sec.)

Touch this key when setting the ventilation time. (1, 3, 5, 10, and 30 minutes.) Press and hold this key for 3 seconds to connect to a home Wi-Fi network.

NOTE

This key is used when connecting the appliance to a home Wi-Fi network. See details on page 40.

MICROWAVE COOKING TIPS

Amount of Food

- **If you increase or decrease** the amount of food you prepare, the time it takes to cook that food will also change. For example, if you double a recipe, add a little more than half the original cooking time. Check for doneness and, if necessary, add more time in small increments.

Starting Temperature of Food

- **The lower the temperature** of the food being put into the microwave oven, the longer it takes to cook. Food at room temperature reheats more quickly than food at refrigerator temperature.

Composition of Food

- **Food with a lot of fat and sugar** heats faster than food containing a lot of water. Fat and sugar also reach a higher temperature than water during the cooking process.
- **The more dense the food**, the longer it takes to heat. Very dense food like meat takes longer to heat than lighter, more porous food like sponge cakes.

Size and Shape

- **Smaller pieces of food** cook faster than larger pieces. Also, same-shaped pieces cook more evenly than different-shaped pieces.
- **With foods that have different thicknesses**, the thinner parts cook faster than the thicker parts. Place the thinner parts of chicken wings and legs in the center of the dish.

Stirring and Turning Foods

- **Stirring and turning foods** spreads heat quickly to the center of the dish and avoids overcooking at the outer edges of the food.

Covering Food

Cover food to:

- **reduce** splattering
- **shorten** cooking times
- **keep** food moist

Releasing Pressure in Foods

- **Several foods** (for example: baked potatoes, sausages, egg yolks, and some fruits) are tightly covered by a skin or membrane. Steam can build up under the membrane during cooking, causing the food to burst. To relieve the pressure and to prevent bursting, pierce these foods before cooking with a fork, cocktail pick, or toothpick.

Using Standing Time

- **Always allow food to stand** either in or out of the oven after cooking power stops. Standing time after defrosting and cooking allows the temperature to evenly spread throughout the food, improving the cooking results. For inside oven standing time, program a 0 power second stage of the cooking cycle. See Cooking with More than One Cook Cycle.
- **The length of the standing time** depends on how much food you are cooking and how dense it is. Sometimes it can be as short as the time it takes you to remove the food from the oven and take it to the serving table. However, with larger, denser food items, the standing time may be as long as 10 minutes.

Arranging Food

For best results, place food evenly on the plate. You can do this in several ways:

- **If you are cooking several items of the same food**, such as baked potatoes, place them in a ring pattern for uniform cooking.
- **When cooking foods of uneven shapes or thickness, such as chicken breasts**, place the smaller or thinner area of the food towards the center of the dish where it will be heated last.
- **Layer thin slices of meat** on top of each other.
- **When you cook or reheat whole fish, score** the skin to prevent cracking.
- **Do not** let food or a container touch the top or sides of the oven. This will prevent possible arcing.

Using Aluminum Foil

Metal containers should not be used in a microwave oven. However, if you have purchased food which is prepackaged in an aluminum foil container, refer to the instructions on the package. When using aluminum foil containers, cooking times may be longer because microwaves will only penetrate the exposed top of the food and not the bottom or the sides. If using aluminum containers without package instructions, follow these guidelines:

- **Place** the aluminum foil container in a glass bowl and add water so that it covers the bottom of the container, but not more than $\frac{1}{4}$ in. (.64 cm) deep. This ensures even heating of the container bottom.
- **Always remove** the container lid to avoid damage to the oven.
- **Use only** undamaged containers.
- **Do not use** containers taller than $\frac{3}{4}$ in. (1.9 cm).
- **Container must be** at least half filled.
- **To avoid arcing**, there must be a minimum $\frac{1}{4}$ in. (.64 cm) between the aluminum container and the walls of the oven and also between two aluminum containers.
- **Always place** the container on the turntable.
- **Shield** parts of food that may cook quickly, such as wing tips and leg ends of poultry, with small pieces of aluminum foil.
- **Heating food** in aluminum foil containers usually takes up to double the time compared to reheating in plastic, glass, china, or paper containers. The cooking time will vary depending upon the type of container you use.
- **Let food stand** for 2 to 3 minutes after heating so that heat is spread evenly throughout the container.

Do Not Can or Sterilize in Oven

- **Do not** try to can food in the oven. Closed glass jars may explode, resulting in damage to the oven.
- **Do not** use the microwave oven to sterilize objects (baby bottles, etc.). It is difficult to keep the oven at the high temperature needed for sterilization.

Removing the Rack

- **When popping commercially packaged popcorn, remove the rack and drip pan from the oven.**

Do not place the bag of microwave popcorn on the rack or under the rack. Leave the glass tray in place at all times.

CAUTION

- Popping microwave popcorn with rack and drip pan in place can cause fire or damage to the microwave oven.

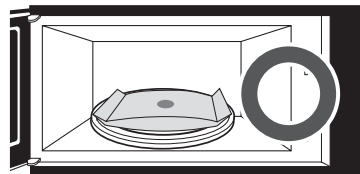
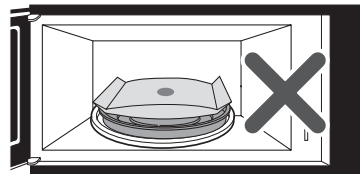
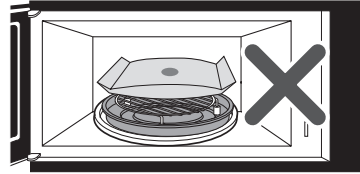

Cooking Comparison Guide

Cooking with your new oven offers a wide variety of food preparation options: microwave cooking, convection cooking, and combination cooking.

Microwave cooking uses very short, high-frequency radio waves. The movement of the microwaves through the food generates heat and cooks most foods faster than regular methods, while retaining their natural texture and moisture. Microwave cooking heats food directly, not the cookware or the interior of the oven. Reheating is easy and defrosting is particularly convenient because less time is spent in food preparation.

Convection cooking constantly circulates heated air around the food, creating even browning and sealed-in flavor by the constant motion of hot air over the food surfaces.

Combination cooking combines microwave energy with convection to cook with speed and accuracy, while browning and crisping to perfection. Timed cooking can be set with microwave cooking, convection cooking, and combination cooking. Preset the desired length of cooking time and the oven turns off automatically.

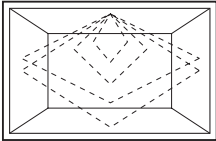
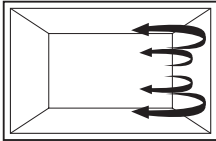
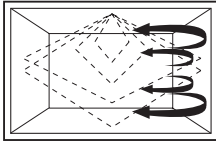
	Microwave	Convection	Combination
Cooking Method	 <p>Microwave energy is distributed evenly throughout the oven for fast, thorough cooking of food.</p>	 <p>Hot air circulates around food to produce browned exteriors and sealed-in juices.</p>	 <p>Microwave energy and convection heat combine to shorten the cooking time of regular ovens, while browning and sealing in juices.</p>
Heat Source	Microwave energy.	Circulating heated air.	Microwave energy and circulating heated air.
Benefits	<ul style="list-style-type: none"> • Fast, high efficiency cooking. • Oven and surroundings do not get hot. • Easy clean-up 	<ul style="list-style-type: none"> • Aids in browning and seals in flavor. • Cooks some foods faster than regular ovens. 	<ul style="list-style-type: none"> • Shortened cooking time from microwave energy. • Browning and crisping from convection heat.

Cookware Guide

Microwave Cooking

Most heat-resistant, non-metallic cookware is safe for use in the microwave oven.

Testing Cookware Before Using

- 1 Place the empty cookware in the microwave oven.
- 2 Measure 1 cup of water in a glass measuring cup and place it in the oven beside the cookware.
- 3 Microwave on 100% power for 1 minute. If the dish is warm, it should not be used for microwave cooking.

Convection Cooking

- Metal pans are recommended for all types of baked products, but especially where browning or crusting is important.
- Dark or dull finish metal pans are best for breads and pies because they absorb heat and produce a crisper crust.
- Shiny aluminum pans are better for cakes, cookies, or muffins because these pans reflect heat and help produce a light, tender crust.
- Glass or glass-ceramic casserole or baking dishes are best suited for egg and cheese recipes to provide easy cleanup.

Combination Cooking

- Glass or glass-ceramic baking containers are recommended. Do not use items with metal trim as they may cause arcing (sparking) with oven wall or oven shelf, damaging the cookware, the shelf, or the oven.
- Heat-resistant plastic microwave cookware (safe to 450°F) may be used, but is not recommended for foods that require crusting or all-around browning, because plastic is a poor conductor of heat.

Cookware	Microwave	Convection	Combination
Heat-Resistant Glass, Ceramic Glass	Yes	Yes	Yes
Ceramics, China	Yes (Do not use china with gold or silver trim.)	Yes	Yes
Metal Cookware	No	Yes	No
Non Heat-Resistant Glass	No	No	No
Microwave-Safe Plastic	Yes	No	Yes*
Plastic Wrap, Wax Paper	Yes	No	No
Paper Products	Yes	No	No
Straw, Wicker, and Wood	Yes	No	No

* Use only microwave cookware that is safe to 450°F

How to use Accessories

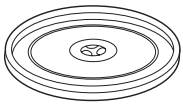

Glass Tray

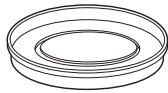

Metal Tray

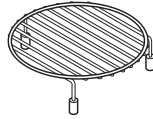



Convection Rack

○ : Possible to use

● : Recommended method

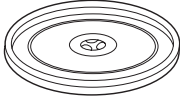
✕ : Do not use

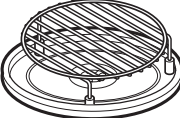
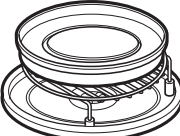
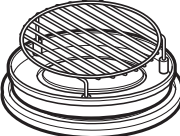
	Microwave	Convection	Combination
	●	○	○
	✕	○	○
	✕	●	●
	✕	●	✕
	✕	●	●

NOTE

- Never operate the oven while empty except to preheat in convection mode.
- NEVER operate the microwave mode while the oven is empty.

OPERATION

Using the Microwave Oven

This section discusses the concepts behind microwave cooking and introduces you to the basics you need to know to operate your microwave oven. Please read this information before using your oven.



CAUTION

To avoid risk of personal injury or property damage, do not use stoneware, metal utensils, or metal trimmed utensils in the oven.

Audible Signals

Audible signals are available to guide you when setting and using your oven:

- A tone will sound each time you touch a key.
- A melody signals the end of a Timer countdown.
- A melody signals the end of a cooking cycle.

Clock

When your microwave oven is first plugged in or after a power failure, the display shows PLEASE SET TIME OF DAY. If a time of day is not set, a colon (:) shows on the display until CUSTOM SET is touched.

Example: To set the clock for 10:30(AM).

- 1 Touch **CUSTOM SET**.
- 2 Turn the dial to select the **CLOCK SET**. Touch **START** or press dial to enter.
- 3 Turn the dial to set the hour 10. Touch **START** or press the dial to enter.
- 4 Turn the dial to set the minute 30. Touch **START** or press the dial to enter.
- 5 Turn the dial to select AM or PM.(AM)
- 6 Touch **START** or press the dial to enter.

NOTE

- If you touch **STOP/CLEAR** while setting the clock, the display shows the last time of day set or a colon (:) if no time of day has been set.
- If you want to save the power on standby status, please keep the display with colon (:) mode.



CAUTION

To avoid risk of personal injury or property damage, do not run oven empty.

Interrupting Cooking

Stop the oven during a cycle by opening the door. The oven stops heating and the fan stops, but the light stays on. To restart cooking, close the door and touch **START**.

To stop cooking, open the door and touch **STOP/CLEAR**.

Child Lock

Use this safety feature to lock the control panel when cleaning the oven, or so children cannot use the oven unsupervised.

Example: To set the child lock.

- 1 Touch and hold **STOP/CLEAR** until **LOCKED** appears in the display and a melody sounds. (approximately 3 seconds)

Example: To cancel the child lock.

- 1 Touch and hold **STOP/CLEAR** until **LOCKED** disappears and a melody sounds. (approximately 3 seconds)

Timer

Use this feature for a general purpose timer. It can be used while cooking in the oven. The timer can be set for up to 99 minutes and 59 seconds.

Example: To set 3 minutes.

- 1 Touch **TIMER ON/OFF**.
- 2 Turn the dial to set the time. (3:00)
- 3 Touch **START** or **TIMER ON/OFF** or press the dial to enter.
 - When the time is over a melody sounds and **END** displays. Press **STOP/CLEAR**.
 - To cancel, press **TIMER ON/OFF**.

Custom Cook

CUSTOM COOK allows one cooking instruction to be placed in memory and then recalled quickly.

Example: To memorize a 2-minute microwave cook.

- 1 Touch **CUSTOM COOK**.
- 2 Touch **MANUAL COOK**.
- 3 Turn the dial to select the cooking type (MICROWAVE). Touch **START** or press the dial to enter.
- 4 Turn the dial to set the power level (POWER 100). Touch **START** or press the dial to enter.
- 5 Turn the dial to set the time.(2:00)
- 6 Touch **START** or press the dial to enter.

Example: To recall the memory.

- 1 Touch **CUSTOM COOK**.
- 2 Touch **START** or press the dial to enter.
 - When the cook time is over a melody sounds and **COOK END** displays.

Vent Fan

The bottom of the control panel controls the 5-speed vent fan.

Example: To set Level 4.

- 1 Touch **ON/OFF**.
The display defaults to the last level selected.
- 2 Touch **5 SPEED** until **LEVEL 4** appears in the display.
Turn off fan when desired.

NOTE

- If the temperature from the range or cooktop below the oven gets too hot, the vent fan in the vent hood automatically turns on at the 4-Speed setting to protect the oven. It may stay on up to an hour to cool the oven. When this occurs, the **VENT ON/OFF** key does not turn the fan off. The vent fan cannot be turned off during microwave cooking.

Vent Fan Auto Timeset

Example: To turn off fan after 30 minutes at level 4.

- 1 Touch **ON/OFF**.
- 2 Touch **5 SPEED** until Level 4 appears in the display.
- 3 Touch **AUTO TIMESET** five times.
 - 1 time - 1 minute
 - 2 times - 3 minutes
 - 3 times - 5 minutes
 - 4 times - 10 minutes
 - 5 times - 30 minutes

NOTE

- **AUTO TIMESET** button is also used when connecting the appliance to a home Wi-Fi network. See details on page 40.

Turntable On/Off

- 1 For best cooking results, leave the turntable on. It can be turned off for large dishes. Touch **TURNTABLE ON/OFF** to turn the turntable on or off.

NOTE

- This option is not available in sensor cook and defrost modes.
- **Sometimes the turntable can become hot to touch.** Be careful when touching the turntable during and after cooking.
- **Do not run the oven empty.**

Light On/Off

- 1 To turn the hood light on, touch **LIGHT ON/OFF** once.
To turn the hood light off, touch **LIGHT ON/OFF** again.

Cooking at High Power Level

Example: To cook food for 8 minutes 30 seconds.

- 1 Turn the dial to select the time. (8:30)
- 2 Touch **START** or press the dial to enter.
 - When the cook time is over a melody sounds and **COOK END** displays.

Custom Set

Use this key to change settings for the clock, beep sound, display speed, and defrost weight.

See the following chart for more information.

Category	Selection
Clock set	Hours
	Minutes
	AM/PM
Sound ON/OFF	Sound ON Sound OFF
Clock ON/OFF	Clock ON Clock OFF
Scroll speed	Slow speed
	Normal speed
	Fast speed
Defrost weight mode	Lbs.
	Kg.

Example: To change defrost weight mode.(from Lbs. to Kg.)

- 1 Touch **CUSTOM SET**.
- 2 Turn the dial to select **Lbs/Kg** Touch **START** or press the dial to enter.
- 3 Turn the selector dial to select **Kg**.
- 4 Touch **START** or press the dial to enter.

Cooking at Lower Power Levels

HIGH power cooking does not always give the best results with foods that need slower cooking, such as roasts, baked goods, or custards. The oven has 10 power settings in addition to HIGH.

Example: To cook food for 7 minutes 30 seconds at 70% power.

- 1 Touch **MANUAL COOK**.
- 2 Turn the dial to select **MICROWAVE**. Touch **START** or press the dial to enter.
- 3 Turn the dial to set the power level (POWER 70). Touch **START** or press the dial to enter.
- 4 Turn the dial to set the time.(7:30)
- 5 Touch **START** or press the dial to enter.
 - When the cook time is over a melody sounds and **COOK END** displays.

Cooking with More than One Cook Cycle

For best results, some recipes call for one power level for a certain length of time, and another power level for another length of time. The oven can be set to change from one power level to another automatically, for up to three cycles if the first heating cycle is defrost.

Example: To cook food for 3 minutes at 100% power and then 70% power for 7 minutes 30 seconds.

- 1 Turn the dial to select the time. (3:00)
- 2 Touch **MANUAL COOK**.
- 3 Turn the dial to set the power level (POWER 70). Touch **START** or press the dial to enter.
- 4 Turn the dial to set the time.(7:30)
- 5 Touch **START** or press the dial to enter.
 - When the cook time is over a melody sounds and **COOK END** displays.

When the first stage is over a melody sounds as the oven begins the second cook stage.

Example: To cook at 70% for 3 minutes and then at 50% for 10 minutes.

- 1 Touch **MANUAL COOK**.
- 2 Turn the dial to select **MICROWAVE**. Touch **START** or press the dial to enter.
- 3 Turn the dial to set the power level (POWER 70). Touch **START** or press the dial to enter.
- 4 Turn the dial to set the time (3:00).
- 5 Touch **MANUAL COOK**.
- 6 Turn the dial to set the power level (POWER 50). Touch **START** or press the dial to enter.
- 7 Turn the dial to set the time (10:00).
- 8 Touch **START** or press the dial to enter.
 - When the cook time is over, a melody sounds and **COOK END** displays.

When the first stage is over, a melody sounds as the oven begins the second cook stage.

Cooking Guide for Lower Power Levels

The nine power levels in addition to HIGH provide a choice of the best level for the food being cooked. Below are listed all the power levels.

Power Level	Microwave Output	Use
100 HIGH	100%	<ul style="list-style-type: none"> • Quick heating many convenience foods and foods with high water content, such as soups and beverages. • Cooking tender cuts of meat, ground meat
90	90%	<ul style="list-style-type: none"> • Heating cream soups
80	80%	<ul style="list-style-type: none"> • Heating rice, pasta, or casseroles
70	70%	<ul style="list-style-type: none"> • Cooking and heating foods that need a cook power lower than high (for example, whole fish and meat loaf) or when food is cooking too fast • Reheating a single serving of food
60	60%	<ul style="list-style-type: none"> • Cooking requiring special care, such as cheese and egg dishes, pudding, and custards • Finishing cooking casseroles
50	50%	<ul style="list-style-type: none"> • Cooking ham, whole poultry, and pot roasts • Simmering stews
40	40%	<ul style="list-style-type: none"> • Melting chocolate • Heating pastries
30	30%	<ul style="list-style-type: none"> • Manually defrosting foods, such as bread, fish, meats, poultry, and precooked foods
20	20%	<ul style="list-style-type: none"> • Softening butter, cheese, and ice cream
10	10%	<ul style="list-style-type: none"> • Keeping food warm • Taking the chill out of fruit
00	0%	<ul style="list-style-type: none"> • Standing time in oven

Sensor Operating Instructions

Sensor Cook cooks favorite foods without selecting cooking times and power levels.

The oven automatically determines required cooking time for each food item. When the internal sensor detects a certain amount of humidity coming from the food, it tells the oven how much longer to heat. The display shows the remaining heating time. For best results when sensor cooking, follow these recommendations.

- 1 Food cooked with the sensor system should be at normal storage temperature.
- 2 The glass tray and the outside of the container should be dry to assure best cooking results.
- 3 Foods should always be covered loosely with microwavable plastic wrap, waxed paper, or a lid.
- 4 Do not open the door or touch **STOP/CLEAR** during the sensing time. When sensing time is over, the oven beeps and the remaining cooking time will appear in the display window. At this time you can open the door to stir, turn, or rearrange the food.

Sensor Cooking Guide

Appropriate containers and coverings help assure good sensor cooking results.

- 1 Always use microwavable containers and cover them with lids or vented plastic wrap.
- 2 Never use tight-sealing plastic covers. They can prevent steam from escaping and cause food to overcook.
- 3 Match the amount to the size of the container. Fill containers at least half full for best results.
- 4 Be sure the outside of the cooking container and the inside of the microwave oven are dry before placing food in the oven. Beads of moisture turning into steam can mislead the sensor.

Sensor Reheat

Use **SENSOR REHEAT** to reheat common microwave-prepared foods without selecting cooking times and power levels.

Example: To reheat slices of pizza.

- 1 Touch **REHEAT**.
- 2 Turn the dial to select **PIZZA SLICE**.
- 3 Touch **START** or press the dial to enter.
 - When the cook time is over a melody sounds and **COOK END** displays.

Sensor Cook

Use **SENSOR COOK** to heat common microwave-prepared foods without needing to program times and power levels. **SENSOR COOK** has preset programs for 6 food categories.

Example: To cook rice.

- 1 Touch **COOK**.
- 2 Turn the dial to select **RICE**.
- 3 Touch **START** or press the dial to enter. After a slight delay, cooking begins.
 - When the cook time is over a melody sounds and **COOK END** displays.

Sensor Popcorn

POPCORN lets you pop commercially packaged microwave popcorn. Pop only one package at a time. For best results, use fresh bags of popcorn.

Example: To pop popcorn.

- 1 Touch **POPCORN**.
 - When the cook time is over a melody sounds and **COOK END** displays.

Sensor Reheat Table

Category	Direction	Amount
Dinner Plate	Place on a low plate. Cover with vented plastic wrap. Let stand 3 minutes after cooking.	1 to 2 servings
Soup/Sauce	Place in shallow microwavable casserole. Cover with vented plastic wrap. After cooking, stir and let stand 3 minutes.	1 - 4 cups
Casserole	Place in a microwavable bowl or casserole. Cover with vented plastic wrap. After cooking, stir and let stand 3 minutes.	1 - 4 cups
Pizza Slice	This function is for re-heating pizza that was cooked previously. It is NOT for raw, ready-to-bake, or frozen pizza. Place the pizza slice(s) on a paper towel or microwave safe plate.	1 - 4 slices

Sensor Cook Table

Category	Direction	Amount
Baked Potato	Pierce each potato with a fork and place on the oven tray around the edge, at least one inch apart. After cooking, allow to stand for 5 minutes.	1 - 4 medium (approx. 8 to 10 oz. each)
Frozen Vegetable	Remove from package, rinse off frost under running water. Place in an appropriately sized microwave container. Add amount of water according to the quantity (1 - 2 cups: 2 tablespoons, 3 - 4 cups: 4 tablespoons). Cover with plastic wrap and vent. After cooking, stir and allow to stand for 3 minutes.	1 - 4 cups
Fresh Vegetable	Prepare as desired, wash, and leave residual water on the vegetables. Place in an appropriately sized microwave container. Add amount of water according to the quantity (1 - 2 cups: 2 tablespoons, 3 - 4 cups: 4 tablespoons). Cover with plastic wrap and vent. After cooking, stir and allow to stand for 3 minutes.	1 - 4 cups
Canned Vegetable	Remove from the can. Place in an appropriately sized microwave container, cover with plastic wrap, and vent. After cooking, stir and allow to stand for 3 minutes.	1 - 4 cups
Frozen Entrée	Remove from outer package. Slit cover. If not in microwave-safe container, place on a plate. Cover with plastic wrap and vent the plastic film by piercing with a fork (3 times). After cooking, allow to stand for 3 minutes.	10 to 21 oz.
Rice	Place rice and twice as much liquid (water, chicken or vegetable stock) in a 2-quart microwave dish. Cover with plastic wrap and vent. After cooking, allow to stand for 10 minutes. Stir for fluffier rice.	½ - 2 cups Use medium or long grain rice. Cook instant rice according to directions on the package.

Tips for Convection Cooking

This section provides cooking instructions and procedures for each convection function.

Convection cooking circulates hot air through the oven cavity with a fan. The constantly moving air surrounds the food to heat the outer portion quickly, creating even browning and sealed-in flavor through the constant motion of hot air over the food surfaces. To use convection cooking, turn the dial to select the Convection or Combination modes. **DO NOT USE THE OVEN WITHOUT THE TURNTABLE IN PLACE.**

- 1 Always use the metal rack** on the turntable when convection cooking.
- 2 Do not cover** the turntable or metal rack with aluminum foil. It interferes with the flow of a
- 3 Use convection cooking** for items like soufflés, breads, cookies, angel food cakes, pizza, and for some meat and fish.
- 4 The oven comes** equipped with a metal tray which can be used for cooking in convection mode or combination mode.
- 5 No special techniques are necessary** to adapt favorite oven recipes to convection cooking; but reduce the oven temperature by 25°F from the recommended temperature when cooking packaged foods in convection mode.
- 6 When baking** cakes, cookies, breads, rolls, or other baked foods, most recipes call for preheating. Preheat the empty oven just as with a regular oven. You can start heavier dense foods such as meats, casseroles, and poultry without preheating.
- 7 All heatproof** cookware or metal utensils can be used in convection cooking.
- 8 As in conventional cooking**, the distance of the food from the heat source affects cooking results. Refer to the charts in this owner's manual.
- 9 Use metal utensils** only for convection cooking. Never use for microwave or combination cooking since arcing and damage to the oven may occur.
- 10 After preheating**, if the door remains closed, the oven automatically holds at the preheated temperature for 30 minutes.

CAUTION

- The oven cavity, door, turntable, roller rest, metal tray, metal rack, and cooking utensils become very hot.

USE THICK OVEN GLOVES when removing the food, cooking utensils, metal rack, metal tray, and turntable from the oven after convection cooking.

- Do not use lightweight plastic containers, plastic wraps, or paper products during any convection cycle.

Convection

During convection cooking, a heating element is used to raise the temperature of the air inside the oven. Convection cooking temperature ranges from 100°F to 450°F.

It is best to preheat the oven when convection cooking.

NOTE

Reduce oven temperature by 25°F from the temperature recommended on packaged foods. The baking time may vary according to the food condition or individual preference.

Example: To set for convection cooking at 325°F for 45 minutes with preheating.

- 1 Touch **MANUAL COOK**.
- 2 Turn the dial to select **CONVECTION**. Touch **START** or press the dial to enter.
- 3 Turn the dial to set the temperature (325°F). Touch **START** or press the dial to enter.
- 4 Touch **START** or press the dial to begin preheating. (Do not enter the time.)
- 5 When the melody sounds, Place the food in the oven.
- 6 Turn the dial to set the time. (45:00)
- 7 Touch **START** or press the dial to enter.

NOTE

- When the oven reaches the set preheat temperature, a melody will sound and the display scrolls the message **PREHEAT END**. The oven automatically holds that temperature for 30 minutes.
- The oven temperature drops very quickly when the door is opened; however, this should not prevent food from being fully cooked during normal cooking time.
- During convection cooking, the vent fan in the vent hood automatically turns on at the 1-speed (lowest speed) setting to protect the oven.

Example: To set for convection cooking at 375°F for 30 minutes without preheating.

- 1 Touch **MANUAL COOK**.
- 2 Turn the dial to select **CONVECTION**. Touch **START** or press the dial to enter.
- 3 Turn the dial to set the temperature (375°F). Touch **START** or press the dial to enter.
- 4 Turn the dial to set the time. (30:00)
- 5 Touch **START** or press the dial to enter.

NOTE

- The temperature range has 10 steps from 100°F to 450°F.

Tips for Combination Cooking

This section provides instructions for each combination cooking function. Combination microwave-convection cooking shortens the cooking time for foods that normally need a long time to cook. It also leaves meat juicy on the inside and crispy on the outside. In combination cooking, the convection heat and microwave energy alternate automatically. The oven has three preprogrammed settings that make it easy to use combination cooking.

Helpful Hints for Combination Cooking

- 1 Meats** can be roasted directly on the metal rack or in a shallow roasting pan placed on the rack. When using the metal rack, check the cooking guide for information on proper use.
- 2 Less tender** cuts of beef can be roasted and tenderized using oven cooking bags.
- 3 When baking**, check for doneness after cooking time is up. If not completely done, let stand in oven for a few minutes to complete cooking.

CAUTION

- All cookware used for combination cooking must be BOTH microwave-safe and oven-safe.
- During combination baking, some baking cookware may cause arcing when it comes in contact with the oven walls or metal accessory racks. Arcing is a discharge of electricity that occurs when microwaves come in contact with metal.
 - If arcing occurs, immediately stop the cooking cycle and place a heat resistant dish between the pan and the metal rack.
 - Use the metal tray supplied with the oven. It has rubber feet that help prevent arcing.
 - If arcing occurs with other baking cookware, do not use them for combination cooking.

Combination Roast

Example: To roast with combination cooking for 45 minutes at 400°F.

- 1** Touch **MANUAL COOK**.
- 2** Turn the dial to select **COMBI**. Touch **START** or press the dial to enter.
- 3** Turn the dial to select **Co-1**.
- 4** Turn the dial to set the temperature. (400°F)
- 5** Turn the dial to set the time. (45:00)
- 6** Touch **START** or press the dial to enter.

NOTE

- The temperature range has 9 steps from 250°F to 450°F.
- During combination cooking, the exhaust fan in the vent hood automatically turns on at the 1-speed (lowest) setting to protect the oven.

Combi	Category	Default Temperature
Co-1	Combination ROAST	Convection 375°F
Co-2	Combination BAKE	Convection 325°F

Auto Cook

Use Auto Cook to heat common microwave-prepared foods without selecting cooking times and power levels.

Auto Cook has preset programs for 6 food functions.

Example: To cook bacon 2 slices.

- 1** Touch **AUTO COOK**.
- 2** Turn the dial to select **AUTO COOK**. Touch **START** or press the dial to enter.
- 3** Turn the dial to select **BACON**. Touch **START** or press the dial to enter.
- 4** Turn the dial to select **2 SLICES**.
- 5** Touch **START** or press the dial to enter.

Auto Cook Table

Category	Direction	Amount
Bacon	Place bacon strips on a microwave bacon rack for best results. (Use dinner plate lined with paper towels if rack is not available).	2 - 6 slices
Fresh Roll/Muffin	Remove from package and place on plate. (If muffins are over 3 oz. each, count each as two when entering quantity).	1 - 6 pieces (2 - 3 oz. each)
Frozen Roll/Muffin	Remove from display package and place on plate. (If muffins are over 3 oz. each, count each as two when entering quantity).	1 - 6 pieces (2 - 3 oz. each)
Beverage	Use a wide-mouth mug. Do not cover. (Be careful. The beverage will be very hot! Sometimes liquids heated in cylindrical containers will splash out when the cup is moved).	1 - 2 cups
Chicken Pieces	Place the chicken pieces in an appropriately sized microwavable container, cover with plastic wrap, and vent.	0.5 - 2 lbs. (0.2 - 0.9 kg)
Hot Cereal	Prepare as directed on package and cook. Stir well before eating. Use only instant hot cereal.	1 - 6 servings

NOTE

- Do not use recycled paper products in the microwave oven. They sometimes contain impurities that cause arcing and sparking.
- **NEVER** use paper products in the convection oven.

Soften

The oven uses low power to soften foods (butter, ice cream, cream cheese, and frozen juice). See the following table.

Example for quart of ice cream.

- 1 Touch **AUTO COOK**.
- 2 Turn the dial to select **SOFTEN**. Touch **START** or press the dial to enter.
- 3 Turn the dial to select **ICE CREAM**. Touch **START** or press the dial to enter.
- 4 Turn the dial to select **QUART**.
- 5 Touch **START** or press the dial to enter.
 - When the cook time is over a melody sounds and **COOK END** displays.

Soften Table

Category	Direction	Amount
Butter	Unwrap and place in microwavable container. Butter will be at room temperature and ready for use in recipe.	1, 2 or 3 sticks
Ice Cream	Place container in oven. Ice cream will be soft enough to make scooping easier.	Pint, Quart, Half gallon
Cream Cheese	Unwrap and place in microwavable Container. Cream cheese will be at room temperature and ready for use in recipe.	3 or 8 oz.
Frozen Juice	Remove top. Place in oven. Frozen juice will be soft enough to mix easily with water.	6, 12 or 16 oz.

Melt

The oven uses low power to melt foods (butter, chocolate, processed cheese food, or marshmallows). See the following table.

Example for 8 oz. of chocolate.

- 1 Touch **AUTO COOK**.
- 2 Turn the dial to select **MELT**. Touch **START** or press the dial to enter.
- 3 Turn the dial to select **CHOCOLATE**. Touch **START** or press the dial to enter.
- 4 Turn the dial to select **8 Oz.**
- 5 Touch **START** or press the dial to enter.
 - When the cook time is over a melody sounds and **COOK END** displays.

Melt Table

Category	Direction	Amount
Butter	Unwrap and place in microwavable container. No need to cover butter. Stir at the end of cooking to complete melting.	1, 2 or 3 sticks
Chocolate	Chocolate chips or squares of baking chocolate may be used. Unwrap squares and place in microwavable container. Stir at the end of cycle to complete melting.	4 or 8 oz.
Cheese	Use processed cheese food only. Cut into cubes. Place in a single layer in microwavable container. Stir at the end of cooking to complete melting.	8 or 16 oz.
Marshmallows	Large or miniature marshmallows may be used. Place in microwavable container. Stir at the end of cycle to complete melting.	5 or 10 oz.

Speed Auto Combination

Use to cook food without entering cooking time or power level on combination mode. SPEED AUTO COMBINATION has 4 food categories.

See the SPEED AUTO COMBINATION CHART on this page for the settings available.

For best results, place food on the rack. When cooking meats, use the metal tray/drip pan to catch drippings.

Example: To cook 2 lb. roast pork.

- 1** Touch **SPEED AUTO COMBI**.
- 2** Turn the dial to select **ROAST PORK**. Touch **START** or press the dial to enter.
- 3** Turn the dial to select **2.0 Lbs**.
- 4** Touch **START** or press the dial to enter.

Speed Auto Combination Chart

Category	Direction	Amount
Whole Chicken	Thoroughly wash inside and outside of chicken with cold water. Pat chicken dry with paper towels, secure the legs with kitchen twine. Brush outside of chicken with melted butter or margarine. Place chicken breast side down on metal rack on metal tray. After cooking, loosely tent chicken with aluminum foil. Let stand for 10 minutes after cooking.	2.0 - 4.0 lbs. (0.9 - 1.8 kg)
Roast Pork	Pat dry with paper towels. Place roast on metal rack on metal tray. After cooking, loosely tent roast with aluminum foil and let stand 5 to 10 minutes.	2.0 - 4.0 lbs. (0.9 - 1.8 kg)
Frozen Lasagna	Remove from outer package. Remove film cover. If lasagna is not in an ovenproof container, place it on an ovenproof dish. Place on metal rack on metal tray. Let stand for 5 minutes after cooking.	10 or 21 oz.
Baked Potatoes	Pierce each potato several times with a fork and place on metal rack on metal tray.	1 - 4 ea

Auto Defrost

Five defrost sequences are preset in the oven. The auto defrost feature provides the best defrosting method for frozen foods. The Auto Defrost Table shows which defrost sequence is recommended.

For added convenience, Auto Defrost includes a built-in beep mechanism as a reminder to check, turn over, separate, or rearrange food to get the best defrost results. Five different defrost settings are provided.

1 MEAT

2 POULTRY

3 FISH

4 BREAD

5 QUICK DEFROST

Example: To defrost 1.2 lbs. of meat.

- 1 Touch **AUTO DEFROST**.
- 2 Turn the selector dial to select the food category. (Meat)
 - Category: Meat, Poultry, Fish, Bread, Quick
- 3 Turn the dial to select the weight. (1.2 Lbs)
- 4 Touch **START** or press the dial to enter.

NOTE

- When you touch the **START** or press the dial, the display changes to the defrost time count down. When the oven beeps during the **DEFROST** cycle, open the door and turn, separate, or rearrange the food. Remove any portions that have thawed. Return frozen portions to the oven and touch **START** to resume the defrost cycle.

Weight Conversion Table

Most food weights are given in pounds and ounces. If using pounds, food weights must be entered into Auto Defrost in pounds and tenths of pounds (decimals).

Use the following table if necessary to convert food weights to decimals.

Equivalent Weight	
OUNCES	DECIMAL WEIGHT
1.6	.10
3.2	.20
4.8	.30
6.4	.40
8.0	.50 One-Half Pound
9.6	.60
11.2	.70
12.8	.80
14.4	.90
16.0	1.00 One Pound

Operating Tips

- For best results, remove fish, shellfish, meat, and poultry from its original closed paper or plastic package (wrapper). Otherwise, the wrap will hold steam and juice close to the foods, which can cause the outer surface of the foods to cook.
- For best results, shape the ground meat into the form of a doughnut before freezing. When defrosting, scrape off thawed meat when the beep sounds and continue defrosting.
- Place foods in a shallow container or on a microwave roasting rack to catch drippings.
- For more defrost help, read Defrosting Tips following the Auto Defrost Table.

For best results, loosen or remove coverings on food.

FOOD	WEIGHTS YOU CAN SET (tenths of a pound)
Meat	0.1 to 6.0 (0.1 - 4 kg)
Poultry	0.1 to 6.0 (0.1 - 4 kg)
Fish	0.1 to 6.0 (0.1 - 4 kg)
Bread	0.1 to 1.0 (0.1 - 0.5 kg)
Quick Defrost	Only 1 lb (0.5 kg only)

Auto Defrost Table

Meat setting

Food	Setting	At Beep	Special Instructions
BEEF			
Ground Beef, Bulk	MEAT	Remove thawed portions with fork Turn over. Return remainder to oven.	Meat of irregular shape and large, fatty cuts of meat should have the narrow or fatty areas shielded with foil at the beginning of a defrost sequence. Do not defrost less than ¼ lb. Freeze in doughnut shape.
Ground Beef, Patties	MEAT	Separate and rearrange.	Do not defrost less than 2 oz. patties. Depress center when freezing.
Round Steak	MEAT	Turn over. Cover warm areas with aluminum foil.	Place on a microwavable roasting rack.
Tenderloin Steak	MEAT	Turn over. Cover warm areas with aluminum foil.	Place on a microwavable roasting rack.
Stew Beef	MEAT	Remove thawed portions with fork. Separate remainder. Return remainder to oven.	Place in a microwavable baking dish.
Pot Roast, Chuck Roast	MEAT	Turn over. Cover warm areas with aluminum foil.	Place on a microwavable roasting rack.
Rib Roast	MEAT	Turn over. Cover warm areas with aluminum foil.	Place on a microwavable roasting rack.
Rolled Rump Roast	MEAT	Turn over. Cover warm areas with aluminum foil.	Place on a microwavable roasting rack.
LAMB			
Cubes for Stew	MEAT	Remove thawed portions with fork. Return remainder to oven.	Place in a microwavable baking dish.
Chops (1 inch thick)	MEAT	Separate and rearrange.	Place on a microwavable roasting rack.
PORK			
Chops (½ inch thick)	MEAT	Separate and rearrange.	Place on a microwavable roasting rack.
Hot Dogs	MEAT	Separate and rearrange.	Place on a microwavable roasting rack.
Spareribs Country-style Ribs	MEAT	Turn over. Cover warm areas with aluminum foil.	Place on a microwavable roasting rack.
Sausage, Links	MEAT	Separate and rearrange.	Place on a microwavable roasting rack.
Sausage, Bulk	MEAT	Remove thawed portions with fork. Turn over. Return remainder to oven.	Place in a microwavable baking dish.
Loin Roast, Boneless	MEAT	Turn over. Cover warm areas with aluminum foil.	Place on a microwavable roasting rack.

Poultry setting

Food	Setting	At Beep	Special Instructions
CHICKEN			
Whole (up to 6 lbs.)	POULTRY	Turn over (finish defrosting breastside down). Cover warm areas with aluminum foil.	Place chicken breast-side up on a microwavable roasting rack. Finish defrosting by immersing in cold water. Remove giblets when chicken is partially defrosted.
Cut-up		Separate pieces and rearrange. Turn over. Cover warm areas with aluminum foil.	Place on a microwavable roasting rack. Finish defrosting by immersing in cold water.
CORNISH HENS			
Whole	POULTRY	Turn over. Cover warm areas with aluminum foil.	Place on a microwavable roasting rack. Finish defrosting by immersing in cold water.
TURKEY			
Breast (up to 6 lbs.)	POULTRY	Turn over. Cover warm areas with aluminum foil.	Place on a microwavable roasting rack. Finish defrosting by immersing in cold water.

Fish setting

Food	Setting	At Beep	Special Instructions
FISH			
Fillets	FISH	Turn over. Separate fillets when partially thawed if possible.	Place in a microwavable baking dish. Carefully separate fillets under cold water.
Steaks	FISH	Separate and rearrange.	Place in a microwavable baking dish. Run cold water over to finish defrosting.
Whole	FISH	Turn over.	Place in a microwavable baking dish. Cover head and tail with foil; do not let foil touch sides of microwave. Finish defrosting by immersing in cold water.
SHELLFISH			
Crabmeat	FISH	Break apart. Turn over.	Place in a microwavable baking dish.
Lobster tails	FISH	Turn over and rearrange.	Place in a microwavable baking dish.
Shrimp	FISH	Separate and rearrange.	Place in a microwavable baking dish.
Scallops	FISH	Separate and rearrange.	Place in a microwavable baking dish.

Bread setting

Food	Setting	At Beep	Special Instructions
BREAD		Turn over and rearrange.	Place on 3 sheets of paper towel.
Bagel	BREAD		Note: Do not use recycled paper products in the microwave oven. They sometimes contain impurities that cause arcing and sparking. NEVER use paper products in the convection oven.
Dinner Roll	BREAD		

Defrosting Tips

- **When using** Auto Defrost, the weight to be entered is the net weight in pounds and tenths of pounds (the weight of the food minus the container).
- **Before starting**, remove the metal twist-ties which often come with frozen food bags, and replace them with strings or elastic bands.
- **Open containers** such as cartons before they are placed in the oven.
- **Always slit** or pierce plastic pouches or packaging.
- **If food is foil wrapped**, remove foil and place the food in a suitable container.
- **Slit** the skins, if any, of frozen food such as sausage.
- **Bend** plastic pouches of food to ensure even defrosting.
- **Always underestimate** defrosting time. If defrosted food is still icy in the center, return it to the microwave oven for more defrosting.
- **The length** of defrosting time varies according to how solidly the food is frozen.
- **The shape of the package** affects how quickly food will defrost. Shallow packages will defrost more quickly than a deep block.
- **As food begins to defrost**, separate the pieces. Separated pieces defrost more easily.
- **Use small pieces of aluminum foil** to shield parts of food such as chicken wings, leg tips, fish tails, or areas that start to get warm. Make sure the foil does not touch the sides, top, or bottom of the oven. The foil can damage the oven lining.
- **For better results**, let food stand after defrosting. (For more information on standing time, see the **Microwave Cooking Tips** section.)
- **Turn over** food during defrosting or standing time. Break apart and remove food as required.

COOKING GUIDE

Convection Baking Guidelines

- 1** Always use the metal rack when convection baking.
Place food directly on rack or place in metal tray and then place tray on rack.
- 2** Aluminum pans conduct heat quickly. For most convection baking, light, shiny finishes give best results because they prevent overbrowning in the time it takes to cook the center areas. Pans with dull (satin-finish) bottoms are recommended for cake pans and pie pans for best bottom browning.
- 3** Dark or non-shiny finishes, glass, and pyroceramic absorb heat which may result in dry, crisp crusts.
- 4** Preheating the oven is recommended when baking foods by convection.
- 5** To prevent uneven heating and save energy, open the oven door to check food as seldom as possible.

Food	Oven Temp.	Time, Min.	Comments	
Breads	Refrigerated Biscuits	375°F	11 to 14	Allow additional time for large biscuits.
	Corn Bread	350°F	35 to 40	
	Muffins	425°F	18 to 22	Remove from pans immediately and cool slightly on wire rack.
	Popovers	325°F	45 to 55	Pierce each popover with a fork after removing from oven to allow steam to escape.
	Nut Bread or Fruit Bread	325°F	60 to 70	Interiors will be moist and tender.
	Yeast Bread	375°F	16 to 23	
	Plain or Sweet Rolls	350°F	13 to 16	Lightly grease baking sheet.
Cakes	Devil's Food	350°F	35 to 40	Place cake pan on rack.
	Fudge brownies	350°F	26 to 30	Bake 2 layers of brownies at a time.
	Coffee Cake	325°F	30 to 35	
	Cup Cakes	325°F	20 to 25	
	Fruit Cake (loaf)	275°F	90 to 100	Interior will be moist and tender.
	Gingerbread	300°F	25 to 30	
	Butter Cakes, Cake Mixes	325°F	35 to 45	
	9 x 13 inch	325°F	35 to 45	Turn end for end half way through baking.
	Tube Cake	325°F	30 to 40	Grease and flour pan.
	Pound Cake	325°F	45 to 55	Cool in pan 10 minutes before inverting on wire rack.
Cookies	Chocolate Chip	350°F	11 to 14	Place metal tray on rack. Allow extra time for frozen cookie dough.
	Sugar	350°F	11 to 14	Place metal tray on rack.
Fruits, Other Desserts	Baked Apples or Pears	350°F	35 to 40	Bake in cookware with shallow sides.
	Bread Pudding	300°F	35 to 40	Pudding is done when knife inserted near center comes out clean.
	Cream Puffs	400°F	30 to 35	Puncture puffs twice with toothpick to release steam after 25 minutes of baking time.
	Meringue Shells	300°F	30 to 35	When done, turn oven off and let shells stand in oven 1 hour to dry.

Food		Oven Temp.	Time, Min.	Comments
Pies, Pastries	Frozen Pie	400°F	50 to 60	Place metal tray on rack and place in cold oven. Preheat oven, tray and rack to 400°F. When preheated, place frozen pie on metal tray and bake according to package time or until crust is browned and filling is hot.
	Meringue-Topped	450°F	9 to 11	Follow package directions for preparation.
	Two-Crust	400°F	50 to 55	Follow package directions for preparation.
	Quiche	350°F	30 to 35	Let stand 5 minutes before cutting.
	Pastry Shell	400°F	10 to 16	Pierce pastry with fork to prevent shrinkage.
Casseroles	Meat, Chicken, Seafood Combinations	350°F	20 to 40	Cook times vary with casserole size and ingredients.
	Pasta	350°F	25 to 45	Cook times vary with casserole size and ingredients.
	Potatoes, scalloped	350°F	55 to 60	Let stand 5 minutes before serving.
	Vegetable	350°F	25 to 35	Cook times vary with casserole size and ingredients.
Convenience Foods	Frozen Bread Dough	350°F	30 to 35	Follow package directions for preparation.
	Frozen Entrée	325°F	70 to 80	Follow package directions for preparation.
	Frozen Pizza Rising Crust	400°F	25 to 35	Follow package directions for preparation. Pizza should not extend over the rack.
	Frozen Pizza	400°F	17 to 21	Follow package directions for preparation. Pizza should not extend over the rack.
	French Fries Crinkle Cut	450°F	15 to 19	Follow package directions for preparation.
	Frozen Waffle	400°F	5 to 7	Follow package directions for preparation.
	Frozen Cheese Sticks	450°F	6 to 8	Follow package directions for preparation.
	Frozen Turnovers	450°F	18 to 22	Follow package directions for preparation.
Main Dishes	Meat Loaf	400°F	30 to 40	Let stand 5 minutes after cooking.
	Oven-Baked Stew	325°F	80 to 90	Brown meat before combining with liquid and vegetables.
	Swiss Steak	350°F	60 to 70	Let stand 2 minutes after cooking.
	Stuffed Peppers	350°F	40 to 45	Use green, red, or yellow peppers.
Vegetables	Acorn Squash Halves	375°F	55 to 60	Pierce skin in several places. Add ½ cup water to dish. Turn squash halves cut side up after 30 minutes of cook time and cover.
	Baked Potatoes	425°F	50 to 60	Pierce skin with fork before baking.
	Twice-Baked Potatoes	400°F	25 to 30	Pierce skin with fork before baking.

NOTE

- The oven temperature indicated in the chart above is recommended over the package instruction temperature.
- The baking time in the chart above is only a guideline for reference. Adjust time according to the food condition or your preference. Check doneness at the minimum time.

Meat Roasting Guidelines for Convection Cooking

Food		Oven Temp.	Time, Min./Lb.
Beef	Ribs (2 to 4 lbs.)		
	Rare	300°F	45 to 50
	Medium	300°F	50 to 55
	Well	300°F	55 to 60
	Boneless Rib, Top Sirloin		
	Rare	300°F	53 to 58
	Medium	300°F	58 to 63
	Well	300°F	63 to 68
	Beef Tenderloin		
	Rare	300°F	28 to 32
	Medium	300°F	32 to 36
Pot Roast (2½ to 3 lbs.)			
Chuck, Rump	300°F	83 to 88	
Meat Loaf (2 lbs.)	400°F	65 to 75	
Ham	Canned (3-lb. fully cooked)	325°F	20 to 25
	Butt (5-lb. fully cooked)	325°F	20 to 25
	Shank (5-lb. fully cooked)	325°F	17 to 20
Lamb	Bone-in (2 to 4 lbs.)		
	Medium	300°F	42 to 47
	Well	300°F	47 to 52
	Boneless (2 to 4 lbs.)		
	Medium	300°F	50 to 55
Well	300°F	55 to 60	
Pork	Bone-in (2 to 4 lbs.)	300°F	48 to 52
	Boneless (2 to 4 lbs.)	300°F	56 to 61
	Pork Chops (½ to 1-inch thick)		
	2 chops	325°F	42 to 45
	4 chops	325°F	45 to 48
6 chops	325°F	48 to 55	
Poultry	Whole Chicken (2½ to 3½ lbs.)	375°F	25 to 35
	Chicken Pieces (2½ to 3½ lbs.)	425°F	10 to 12
	Duckling (4 to 5 lbs.)	375°F	19 to 21
	Turkey Breast (4 to 6 lbs.)	325°F	21 to 25
Seafood	Fish, whole (3 to 5 lbs.)	400°F	13 to 18
	Lobster Tails (6 to 8-oz. each)	350°F	12 to 17

NOTE

- The roasting time in the chart above is only a guideline for reference. Adjust time according to the food condition or your preference. Check doneness at the minimum time.

Combination Roast Cooking Guide

Food		Oven Temp.	Time, Min./Lb.
Beef	Turn over after half of cooking time.		
	Ribs (2 to 4 lbs.)		
	Rare	375°F	9 to 13
	Medium	375°F	11 to 15
	Well	375°F	13 to 17
	Boneless Rib, Top Sirloin		
	Rare	375°F	9 to 13
	Medium	375°F	11 to 15
	Well	375°F	13 to 17
	Beef Tenderloin		
	Rare	375°F	16 to 18
Medium	375°F	18 to 20	
Chuck, Rump or Pot Roast (2½ to 3 lbs.) (Use cooking bag for best results.)	300°F	18 to 20	
Ham	Turn over after half of cooking time.		
	Canned (3-lb. fully cooked)	300°F	15 to 18
	Butt (5-lb. fully cooked)	300°F	15 to 18
	Shank (5-lb. fully cooked)	300°F	15 to 18
Lamb	Turn over after half of cooking time.		
	Bone-in (2 to 4 lbs.)		
	Medium	300°F	13 to 18
	Well	300°F	18 to 23
	Boneless (2 to 4 lbs.)		
	Medium	300°F	14 to 19
Well	300°F	19 to 24	
Pork	Turn over after half of cooking time.		
	Bone-in (2 to 4 lbs.)	300°F	17 to 20
	Boneless (2 to 4 lbs.)	300°F	19 to 22
	Pork Chops (¾ to 1-inch thick)		
	2 chops	350°F	10 to 13
	4 chops	305°F	13 to 16
	6 chops	305°F	16 to 19
Poultry	Turn over after half of cooking time.		
	Whole Chicken (2½ to 6 lbs.)	375°F	15 to 17
	Chicken Pieces (2½ to 6 lbs.)	375°F	15 to 18
	Cornish Hens (untied)		
	Unstuffed	425°F	15 to 18
	Stuffed	375°F	22 to 25
	Duckling	375°F	15 to 18
Turkey Breast (4 to 6 lbs.)	300°F	11 to 15	

Food		Oven Temp.	Time, Min./Lb.
Seafood	Fish		
	1-lb. fillets	350°F	7 to 10
	Lobster Tails (6 to 8-oz. each)	350°F	10 to 15
	Shrimp (1 to 2 lbs.)	350°F	9 to 14
	Scallops (1 to 2 lbs.)	350°F	8 to 13

NOTE

- The roasting time in the chart above is only a guideline for reference. Adjust time according to the food condition or your preference. Check doneness at the minimum time.

Combination Bake Cooking Guide

Food		Oven Temp.	Time, Min.	Comments
Pies, Pastries	Quiche	425°F	15 to 17	Let stand 5 minutes before cutting.
Convenience Foods	Frozen Entrée	375°F	39 to 43	Follow package directions for preparation.
	Frozen Pizza Rolls, Egg Rolls	450°F	4 to 6	Follow package directions for preparation.
	Pizza	450°F	23 to 26	Follow package directions for preparation.
Vegetables	Baked Potatoes	450°F	36 to 40	Pierce skin with a fork before baking. Place on rack.

Heating/Reheating Guide

To heat or reheat successfully in a microwave oven, follow these guidelines: Measure the amount of food in order to determine the time needed to reheat. Arrange the food in a circular pattern for best results. Room temperature food will heat faster than refrigerated food. Canned foods should be taken out of the can and placed in a microwave-safe container. The food will heat more evenly if covered with a microwave-safe lid or vented plastic wrap. Remove the cover carefully to prevent steam burns. Use the following chart as a guide for reheating cooked food.

Items	Cook Time (At High)	Special Instructions
Sliced meat 3 slices (¼ -inch thick)	1 - 2 minutes	Place sliced meat on microwavable plate. Cover with plastic wrap and vent. Note: Gravy or sauce helps to keep meat juicy.
Chicken pieces 1 breast 1 leg and thigh	2 - 3½ minutes 1½ - 3 minutes	Place chicken pieces on microwavable plate. Cover with plastic wrap and vent.
Fish fillet (6 - 8 oz.)	2 - 4 minutes	Place fish on microwavable plate. Cover with plastic wrap and vent.
Lasagna 1 serving (10½ oz.)	4 - 6 minutes	Place lasagna on microwavable plate. Cover with plastic wrap and vent.
Casserole 1 cup 4 cups	1 - 3½ minutes 5 - 8 minutes	COOK covered in microwavable casserole. Stir once halfway through cooking.
Casserole – cream or cheese 1 cup 4 cups	1½ - 3 minutes 3½ - 5½ minutes	COOK covered in microwavable casserole. Stir once halfway through cooking.
Sloppy Joe or Barbecued Beef 1 sandwich (½ cup meat filling)without bun	1 - 2½ minutes	Reheat filling and bun separately. Cook filling covered in microwavable casserole. Stir once. Heat bun as directed in chart below.
Mashed potatoes 1 cup 4 cups	1 - 3 minutes 5 - 8 minutes	COOK covered in microwavable casserole. Stir once halfway through cooking.
Baked beans 1 cup	1½ - 3 minutes	COOK covered in microwavable casserole. Stir once halfway through cooking.
Ravioli or pasta in sauce 1 cup 4 cups	2½ - 4 minutes 7½ - 11 minutes	COOK covered in microwavable casserole. Stir once halfway through cooking.
Rice 1 cup 4 cups	1½ - 3½ minutes 4 - 6½ minutes	COOK covered in microwavable casserole. Stir once halfway through cooking.
Sandwich roll or bun 1 roll	15 - 30 seconds	Wrap in paper towel and place on glass microwavable rack.
Vegetables 1 cup 4 cups	1½ - 2½ minutes 4 - 6 minutes	COOK covered in microwavable casserole. Stir once halfway through cooking.
Soup 1 serving (8 oz.)	1½ - 2½ minutes	COOK covered in microwavable casserole. Stir once

Fresh Vegetable Guide

Vegetable	Amount	Cook Time At High (Minute)	Instructions	Standing Time
Artichokes (8 oz.each)	2 medium 4 medium	5 - 8 10 - 13	Trim. Add 2 tsp water and 2 tsp juice. Cover.	2 - 3 minutes
Asparagus, Fresh, Spears	1 lb.	3 - 6	Add ½ cup water. Cover.	2 - 3 minutes
Beans, Green and Wax	1 lb.	7 - 11	Add ½ cup water in 1½ qt. casserole. Stir halfway through cooking.	2 - 3 minutes
Beets, Fresh	1 lb.	12 - 16	Add ½ cup water in 1½ qt. covered casserole. Rearrange halfway through cooking.	2 - 3 minutes
Broccoli, Fresh, Spears	1 lb.	4 - 8	Place broccoli in baking dish. Add ½ cup water.	2 - 3 minutes
Cabbage, Fresh, Chopped	1 lb.	4 - 7	Add ½ cup water in 1½ qt. covered casserole. Stir halfway through cooking.	2 - 3 minutes
Carrots, Fresh, Sliced	2 cups	2 - 4	Add ¼ cup water in 1 qt. covered casserole. Stir halfway through cooking.	2 - 3 minutes
Cauliflower, Fresh, Whole	1 lb.	7 - 11	Trim and add ¼ cup water in 1 qt. covered casserole. Stir halfway through cooking.	2 - 3 minutes
Flowerettes, Fresh Celery, Fresh, Sliced	2 cups 4 cups	2½ - 4½ 6 - 8	Slice and add ½ cup water in 1½ qt. covered casserole. Stir halfway through cooking.	2 - 3 minutes
Corn, Fresh	2 ears	5 - 9	Husk and add 2 tbsp water in 1½ qt. baking dish. Cover.	2 - 3 minutes
Mushrooms, Fresh, Sliced	½ lb.	2 - 3½	Place mushrooms in 1½ qt. covered casserole. Stir halfway through cooking.	2 - 3 minutes
Parsnips, Fresh, Sliced	1 lb.	4 - 8	Add ½ cup water in 1½ qt. covered casserole. Stir halfway through cooking.	2 - 3 minutes
Peas, Green, Fresh	4 cups	7 - 10	Add ½ cup water in 1½ qt. covered casserole. Stir halfway through cooking.	2 - 3 minutes
Sweet Potatoes	2 medium	5 - 10	Pierce potatoes several times with fork.	2 - 3 minutes
Whole Baking (6-8 oz.each)	4 medium	7 - 13	Place on 2 paper towels. Turn over halfway through cooking.	2 - 3 minutes
White Potatoes	2 potatoes	5 - 8	Pierce potatoes several times with fork.	2 - 3 minutes
Whole Baking (6-8 oz.each)	4 potatoes	10 - 14	Place on 2 paper towels. Turn over halfway through cooking.	2 - 3 minutes
Spinach, Fresh, Leaf	1 lb.	4 - 7	Add ½ cup water in 2 qt. covered casserole.	2 - 3 minutes
Squash, Acorn or Butternut, Fresh	1 medium	6 - 8	Cut squash in half. Remove seeds. Place in 8 x 8-inch baking dish. Cover.	2 - 3 minutes
Zucchini, Fresh, Sliced	1 lb.	4½ - 7½	Add ½ cup water in 1½ qt. covered casserole. Stir halfway through cooking.	2 - 3 minutes
Zucchini, Fresh, Whole	1 lb.	6 - 9	Pierce. Place on 2 paper towels. Turn over and rearrange halfway through cooking.	2 - 3 minutes

SMART FUNCTIONS

Application Installation

Search for the SIGNATURE KITCHEN SUITE application from the Google Play Store on a smart phone. Follow instructions to download and install the application.

Product Registration

- 1 Run the SIGNATURE KITCHEN SUITE application on a smart phone.
- 2 Create an account and sign in.
- 3 Select **Register**.
- 4 Select **Microwave oven**.
- 5 Follow the instructions on the smart phone to register the appliance and connect it to a Wi-Fi network.
 - To verify the Wi-Fi connection, check the Wi-Fi icon  on the control panel is lit.

NOTE

- SIGNATURE KITCHEN SUITE is not responsible for any network connection problems or any faults, malfunctions, or errors caused by network connection.
- The machine supports 2.4 GHz Wi-Fi networks only.
- If the appliance is having trouble connecting to the Wi-Fi network, it may be too far from the router. Purchase a Wi-Fi repeater (range extender) to improve the Wi-Fi signal strength.
- The Wi-Fi connection may not connect or may be interrupted because of the home network environment.
- The network connection may not work properly depending on the internet service provider.
- The surrounding wireless environment can make the wireless network service run slowly.
- This information is current at the time of publication.
The application is subject to change for appliance improvement purposes without notice to users.

Using the Wi-Fi Function

Communicate with the appliance from a smart phone using the convenient smart features.

Using the Application

- 1 Select the appliance in the application and connect it to a Wi-Fi network.
- 2 Select the menu on the upper right side to access settings and features.

Monitoring

Check the current status, cook mode, settings, remaining cook time, and cook end time for the appliance on a single screen.

Push Alert

Turn on the Push Alerts to receive appliance status notifications.

The notifications are triggered even if the Signature Kitchen Suite application is off.

Smart Diagnosis

Smart Diagnosis™ helps troubleshoot and diagnose issues with the appliance based on how the product is used. The smart phone application can record and analyze the Smart Diagnosis™ signal without waiting for a technician.

Settings

Set various options on the appliance and in the application.

Interworking Function

The appliance automatically turns on/off the vent fan and cooktop lamp when paired with Signature Kitchen Suite cooktops. Both products must be registered through the Signature Kitchen Suite application and have an interworking function.

NOTE

- The appliance is not intended to be operated by means of remote control system.
- Vent or Light functions which are automatically activated by an interworking cooktop can be turned off by pressing Vent On/Off or Light On/Off on the appliance.
- To disconnect the appliance from the Wi-Fi network, delete the microwave oven from the list of registered products in the Signature Kitchen Suite application.

Open Source Software Notice Information

To obtain the source code under GPL, LGPL, MPL, and other open source licenses, that is contained in this product, please visit <http://opensource.thesignaturekitchen.com>. In addition to the source code, all referred license terms, warranty disclaimers and copyright notices are available for download.

SIGNATURE KITCHEN SUITE will also provide open source code to you on CD-ROM for a charge covering the cost of performing such distribution (such as the cost of media, shipping, and handling) upon email request to opensource@thesignaturekitchen.com. This offer is valid for three (3) years from the date on which you purchased the product.

Wireless module (LCW-003) Specifications	
Frequency Range	2412~2462 MHz
Output Power (max.)	IEEE 802.11 b : 14 dBm IEEE 802.11 g : 15 dBm IEEE 802.11 n : 14 dBm

FCC Notice (For transmitter module contained in this product)

This equipment has been tested and found to comply with the limits for a Class B digital device, pursuant to Part 15 of the FCC Rules. These limits are designed to provide reasonable protection against harmful interference in a residential installation. This equipment generates, uses, and can radiate radio frequency energy and, if not installed and used in accordance with the instructions, may cause harmful interference to radio communications. However, there is no guarantee that interference will not occur in a particular installation. If this equipment does cause harmful interference to radio or television reception, which can be determined by turning the equipment off and on, the user is encouraged to try to correct the interference by one or more of the following measures:

- Reorient or relocate the receiving antenna.
- Increase the separation between the equipment and the receiver.
- Connect the equipment to an outlet on a circuit different from that to which the receiver is connected.
- Consult the dealer or an experienced radio/TV technician for help.

This device complies with part 15 of the FCC Rules. Operation is subject to the following two conditions:

- 1) this device may not cause harmful interference and
- 2) this device must accept any interference received, including interference that may cause undesired operation of the device.

Any changes or modifications in construction of this device which are not expressly approved by the party responsible for compliance could void the user's authority to operate the equipment.

FCC RF Radiation Exposure Statement

This equipment complies with FCC radiation exposure limits set forth for an uncontrolled environment. This transmitter must not be co-located or operating in conjunction with any other antenna or transmitter.

This equipment should be installed and operated with minimum distance 20 cm (7.8 inches) between the antenna and your body. Users must follow the specific operating instructions for satisfying RF exposure compliance.

SMART DIAGNOSIS™

Using Smart Diagnosis™

Should you experience any problems with the appliance, it has the capability of transmitting data to a smart phone using the SIGNATURE KITCHEN SUITE application or via the phone to the SIGNATURE KITCHEN SUITE call center.

Smart Diagnosis™ can not be activated unless the appliance is connected to power. If the appliance is unable to turn on, then troubleshooting must be done without using Smart Diagnosis™.

Smart Diagnosis™ Using a Smart Phone

- 1 Open the SIGNATURE KITCHEN SUITE application on the smart phone.
- 2 Select the appliance and then the menu on upper right side.
- 3 Select the Smart Diagnosis, then press Start Smart Diagnosis button.

NOTE

- If the diagnosis fails several times, use the following instructions.

- 4 Select the **Audible Diagnosis**.
- 5 Follow the instructions on the smart phone.
- 6 Keep the phone in place until the tone transmission has finished. View the diagnosis on the phone.

NOTE

- The Smart Diagnosis™ function depends on the local call quality.
- The communication performance will improve and you can receive better service if you use the home phone.
- If the Smart Diagnosis™ data transfer is poor due to poor call quality, you may not receive the best Smart Diagnosis™ service.

Smart Diagnosis™ Through the Customer Information Center

- 1 Call the SIGNATURE KITCHEN SUITE call center at: 1-855-790-6655
- 2 When instructed to do so by the call center agent, hold the mouthpiece of your phone over the Smart Diagnosis™ logo on the machine. Hold the phone no more than one inch from (but not touching) the machine.

NOTE

Do not touch any other buttons or icons on the display screen.

- 3 Press and hold the **Start** button for three seconds.
- 4 Keep the phone in place until the tone transmission has finished. The display will count down the time.
- 5 Once the countdown is over and the tones have stopped, resume your conversation with the call center agent, who will then be able to assist you in using the information transmitted for analysis.

NOTE

- For best results, do not move the phone while the tones are being transmitted.
- If the call center agent is not able to get an accurate recording of the data, you may be asked to try again.

MAINTENANCE

Caring for the Microwave Oven

To make sure the microwave oven looks good and works well for a long time, maintain it properly. For proper care, follow these instructions carefully.

For interior surfaces: Wash often with warm, sudsy water and a sponge or soft cloth. Use only mild, nonabrasive soaps or a mild detergent. **Keep the areas clean where the door and oven frame touch when closed.**

Wipe well with a clean cloth. Over time, stains can occur on the surfaces as the result of food particles spattering during cooking. This is normal.

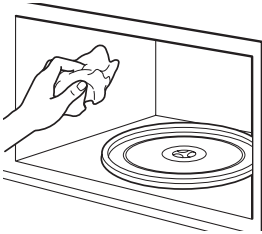

For stubborn soil, boil a cup of water in the oven for 2 to 3 minutes. Steam will soften the soil. To get rid of odors inside the oven, boil a cup of water with some lemon juice or vinegar in it.

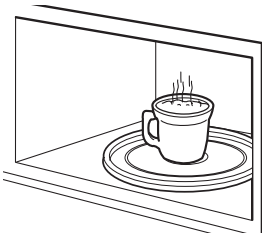

For exterior surfaces and control panel: Use a soft cloth sprayed with glass cleaner. Apply the glass cleaner to the soft cloth; do not spray directly on the oven.

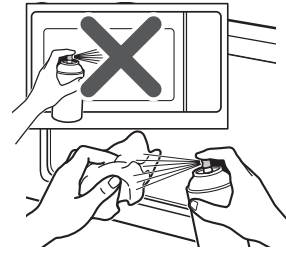

NOTE

- **Abrasive cleansers, steel wool pads, gritty wash cloths, some paper towels, etc.,** can damage the control panel and the interior and exterior oven surfaces.

To clean the glass tray and rotating ring, wash in mild, sudsy water.

For heavily soiled areas use a mild cleanser and scouring sponge.

The glass tray and rotating ring are dishwasher safe.

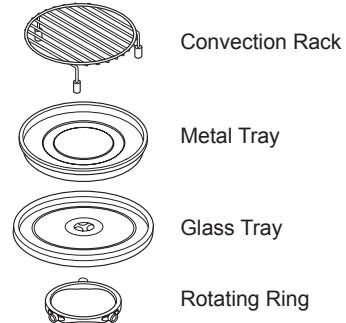

Cleaning the Grease Filters

- 1 **Unplug** the microwave oven.
- 2 **To remove** grease filters, slide each filter to the side. Pull filters downward and push to the other side. The filter will drop out.

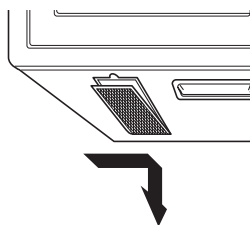

- 3 **Soak** grease filters in hot water and a mild detergent. **Scrub and swish** to remove embedded dirt and grease. **Rinse well and shake to dry.** **Do not clean filters with ammonia, corrosive cleaning agents such as lye-based oven cleaners, or place them in a dishwasher.** The filters will turn black or could be damaged.

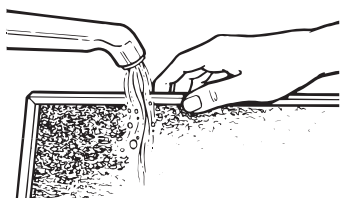

- 4 **To replace** grease filters, slide filter in the frame slot on one side of the opening. Push filter upward and push to the other side to lock into place.

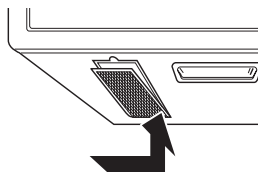

- 5 **Plug in** the microwave oven.

Charcoal Filter Replacement

- 1 **Unplug** the microwave oven.
- 2 **Remove** the vent grille mounting screws.

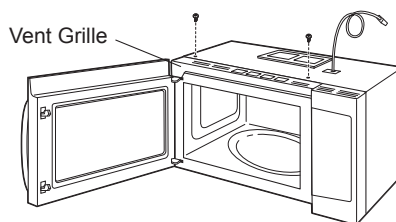

- 3 **Tip** the grille forward, then **lift out** to remove.
- 4 **Remove** the charcoal filter.

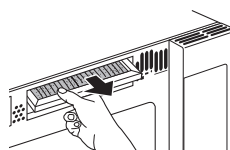

- 5 **Slide** a new charcoal filter into place. The filter should rest at the angle shown.

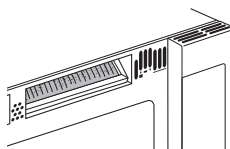

- 6 **Slide** the bottom of the vent grille into place. **Push** the top until it snaps into place. **Replace** the mounting screws.
- 7 **Plug in** the microwave oven.

Oven Light Replacement

- 1 **Unplug** the microwave oven.
- 2 **Remove** the vent grille mounting screws.
- 3 **Tip** the grille forward, then **lift out** to remove.

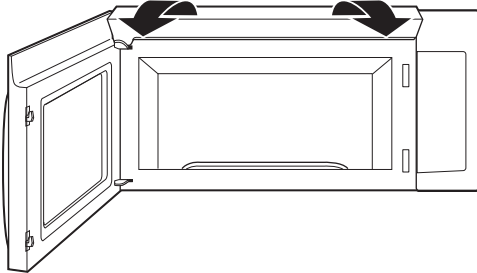

- 4 **Remove** charcoal filter.
- 5 **Remove** the screw holding the lamp shield in place.

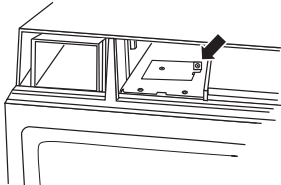

- 6 **Pull** the lamp shield out.

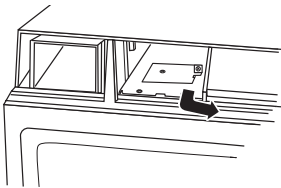

- 7 **Replace** the bulb with a candelabra-base 50 watt bulb.
- 8 **Return** the lamp and lamp shield to original position and replace screw and charcoal filter.
- 9 **Replace** the mounting screws.
- 10 **Plug in** the microwave oven.

Cooktop/Countertop Light Replacement

- 1 **Unplug** the microwave oven.

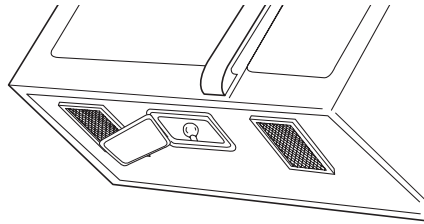

- 2 **Remove** the bulb cover mounting screws.
- 3 **Replace** bulb(s) with candelabra-base 50 watt bulb.
- 4 **Replace** bulb cover and mounting screw.
- 5 **Plug in** the microwave oven.

Microwave Utensil Guide

Use	Do Not Use
<p>OVENPROOF GLASS (treated for high intensity heat): utility dishes, loaf dishes, pie plates, cake plates, liquid measuring cups, casseroles and bowls without metallic trim.</p> <p>CHINA: bowls, cups, serving plates, and platters without metallic trim.</p> <p>PLASTIC: Plastic wrap (as a cover)- lay the plastic wrap loosely over the dish and press it to the sides. Vent plastic wrap by turning back one edge slightly to allow excess steam to escape. The dish should be deep enough so that the plastic wrap will not touch the food. As the food heats it may melt the plastic wrap wherever the wrap touches the food. Use plastic dishes, cups, semi-rigid freezer containers and plastic bags only for short cooking time. Use these with care because the plastic may soften from the heat of the food.</p> <p>PAPER: Paper towels, waxed paper, paper napkins, and paper plates with no metallic trim or design. Look for the manufacturer's label for use in the microwave oven.</p> <p>Note: Do not use recycled paper products in the microwave oven. They sometimes contain impurities that cause arcing and sparking.</p> <p>NEVER use paper products in the convection oven.</p>	<p>METAL CONTAINERS:: Metal shields the food from microwave energy and produces uneven cooking. Also avoid metal skewers, thermometers, or foil trays. Metal containers can cause arcing, which can damage the microwave oven.</p> <p>METAL DECORATION: Metal-trimmed or metal-banded dinnerware, casserole dishes, etc. The metal trim interferes with normal cooking and may damage the oven.</p> <p>ALUMINUM FOIL: Avoid large sheets of aluminum foil because they hinder cooking and may cause harmful arcing. Use small pieces of foil to shield poultry legs and wings. Keep ALL aluminum foil at least 1 inch from the side walls and door of the oven.</p> <p>WOOD: Wooden bowls and boards will dry out and may split or crack when you use them in the microwave oven. Baskets react in the same way.</p> <p>TIGHTLY COVERED UTENSILS: Be sure to leave openings for steam to escape from covered containers. Pierce plastic pouches of vegetables or other food items before cooking. Tightly closed pouches could explode.</p> <p>BROWN PAPER: Avoid using brown paper bags. They absorb too much heat and could burn.</p> <p>FLAWED OR CHIPPED UTENSILS: Any container that is cracked, flawed, or chipped may break in the oven.</p> <p>METAL TWIST TIES: Remove metal twist ties from plastic or paper bags. They become hot and could cause a fire.</p>

TROUBLESHOOTING

Frequently Asked Questions

Can I use a rack in my microwave oven to reheat or cook on two levels at once?

Only use the rack that is supplied with your microwave oven. Use of any other rack can result in poor cooking performance and/or arcing and may damage your oven.

Can I use either metal or aluminum pans in my microwave oven?

Usable metal includes aluminum foil for shielding (use small, flat pieces), and shallow foil trays (if tray is $\frac{3}{4}$ inch deep and filled with food to absorb microwave energy). Never allow metal to touch walls or door.

Sometimes the door of my microwave oven appears wavy. Is this normal?

This appearance is normal and does not affect the operation of your oven.

The glass tray does not move.

The glass tray is not correctly in place. It should be correct-side up and sitting firmly on the center hub. The support is not operating correctly. Remove the glass tray and restart the oven. Cooking without the glass tray can give you poor results.

Why does the dish become hot when I microwave food in it? I thought that this should not happen.

As the food becomes hot it will conduct the heat to the dish. Use hot pads to remove food after cooking.

What does standing time mean?

Standing time means that food should be taken out of the oven and covered for additional time after cooking. This process allows the cooking to finish, saves energy, and frees the oven for other purposes.

Can I pop popcorn in my microwave oven? How do I get the best results?

Yes. Pop packaged microwave popcorn following manufacturer's guidelines or use the preprogrammed Popcorn key.

Do not use regular paper bags. Use the listening test by stopping the oven as soon as the popping slows to a pop every one or two seconds. Do not try to repop unpopped kernels. You can also use special microwave poppers. When using a popper, be sure to follow manufacturer's directions. Do not pop popcorn in glass utensils.

Why does steam come out of the air exhaust vent?

Steam is normally produced during cooking. The microwave oven has been designed to vent steam out of the top vent.

Before Calling for Service

Check the following list to be sure a service call is really necessary. A quick reference of this manual as well as reviewing additional information on items to check may prevent an unneeded service call.

Symptoms	Possible Causes / Solutions
If nothing on the oven operates:	<ul style="list-style-type: none"> • Check for a blown circuit fuse or a tripped main circuit breaker. • Check if oven is properly connected to electric circuit in house. • Check that controls are set properly.
If the oven interior light does not work	<ul style="list-style-type: none"> • The light bulb is loose or defective.
If oven will not cook:	<ul style="list-style-type: none"> • Check that control panel was programmed correctly. • Check that door is firmly closed. • Check that start was pressed. • Check that timer wasn't started instead of a cook function.
If oven takes longer than normal to cook or cooks too rapidly:	<ul style="list-style-type: none"> • Be sure the power level is programmed properly.
If the time of day clock does not always keep correct time:	<ul style="list-style-type: none"> • Check that the power cord is fully inserted into the outlet receptacle. • Be sure the oven is the only appliance on the electrical circuit.
If food cooks unevenly:	<ul style="list-style-type: none"> • Be sure food is evenly shaped. • Be sure food is completely defrosted before cooking. • Check placement of aluminum foil strips used to prevent overcooking.
If food is undercooked:	<ul style="list-style-type: none"> • Check recipe to be sure all directions (amount, time, and power levels) were correctly followed. • Be sure microwave oven is on a separate circuit. • Be sure food is completely defrosted before cooking.
If food is overcooked:	<ul style="list-style-type: none"> • Check recipe to be sure all directions (amount, power level, time, size of dish) were followed.
If arcing (sparks) occur:	<ul style="list-style-type: none"> • Be sure microwavable dishes were used. • Be sure wire twist ties weren't used. • Be sure oven wasn't operated when empty. • Make sure metal rack (if used) is properly installed on 4 supports.
If the display shows a time counting down but the oven is not cooking:	<ul style="list-style-type: none"> • Check that door is firmly closed. • Check that timer wasn't started instead of a cooking function.

WARRANTY(USA)

SIGNATURE KITCHEN SUITE will repair or replace your product, at SIGNATURE KITCHEN SUITE'S option, if it proves to be defective in material or workmanship under normal use, during the warranty period set forth below, effective from the date of original consumer purchase of the product. This warranty is good only to the original purchaser of the product and effective only when used in the United States, including U.S Territories.

Warranty Period	HOW SERVICE IS HANDLED
<p>LABOR: Three Years from the Date of Purchase*.</p> <p>PARTS(except as listed below): Three Years from the Date of Purchase*.</p> <p>MAGNETRON: Ten Years from the Date of Purchase*.</p> <p>Replacement Units and Repair Parts are warranted for the remaining portion of the original unit's warranty period.</p> <p>* Retain your Sales Receipt to prove the date of purchase. A copy of your Sales Receipt must be submitted at the time warranty service is provided.</p>	<p>Please call 1-855-790-6655 and choose the appropriate option. (Phones are answered 24 hours a day, 365 days per year.) Please have the product type (Microwave) and your ZIP code ready.</p> <p>Or visit our website at: www.thesignaturekitchen.com</p>

THIS WARRANTY IS IN LIEU OF ANY OTHER WARRANTY, EXPRESS OR IMPLIED, INCLUDING WITHOUT LIMITATION, ANY WARRANTY OF MERCHANTABILITY OR FITNESS FOR A PARTICULAR PURPOSE. TO THE EXTENT ANY IMPLIED WARRANTY IS REQUIRED BY LAW, IT IS LIMITED IN DURATION TO THE EXPRESS WARRANTY PERIOD ABOVE. SIGNATURE KITCHEN SUITE WILL NOT BE LIABLE FOR ANY INCIDENTAL, CONSEQUENTIAL, INDIRECT, SPECIAL, OR PUNITIVE DAMAGES OF ANY NATURE, INCLUDING WITHOUT LIMITATION, LOST REVENUES OR PROFITS, OR ANY OTHER DAMAGE WHETHER BASED IN CONTRACT, TORT, OR OTHERWISE.

Some states do not allow the exclusion or limitation of incidental or consequential damages or limitations on how long an implied warranty lasts, so the above exclusion or limitation may not apply to you. This warranty gives you specific legal rights and you may also have other rights that vary from state to state.

THIS LIMITED WARRANTY DOES NOT APPLY TO:

- Service trips to deliver, pick up, or install or repair the product; instruction to the customer on operation of the product; service trips to your home to deliver, pick up, and/or install the product, instruct, or replace house fuses or correct wiring, or correction of unauthorized repairs.
- Damages or operating problems that result from misuse, abuse, operation outside environmental specifications or contrary to the requirements of precautions in the Operating Guide, accident, vermin, fire, flood, improper installation, acts of God, unauthorized modification or alteration, incorrect electrical current or voltage, or commercial use, or use for other than intended purpose.

The cost of repair or replacement under these excluded circumstances shall be borne by the consumer.

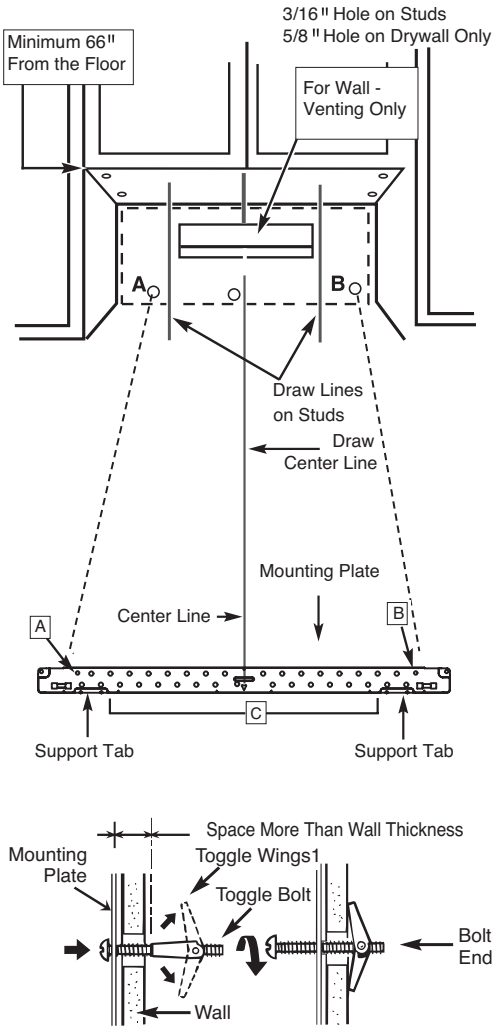
Problem	Cause	Solution
<p>Microwave oven Installation issue</p> <ul style="list-style-type: none"> • Vibration noise • Unit is not level • Installation damage 	<ol style="list-style-type: none"> 1. Mounting bracket screw not fixed completely 2. Mounting plate not aligned  <ol style="list-style-type: none"> 3. Product carried/installed improperly 	<p>Check with installer first</p>
<p>Spark / Arcing</p>	<p>Aluminum foil or metal utensil used in microwave mode</p>	<p>DO NOT use aluminum foil or metal utensils in microwave mode</p> <ul style="list-style-type: none"> • Check user instructions
<p>Unit has no power</p>	<ol style="list-style-type: none"> 1. House power turned off (power supply) 2. Tripped breaker 3. The power cord is not installed properly 	<ol style="list-style-type: none"> 1. Check house power supply 2. Check proper power cord connection 3. Check extension cord

The cost of repair or replacement under these excluded circumstances shall be borne by the consumer.

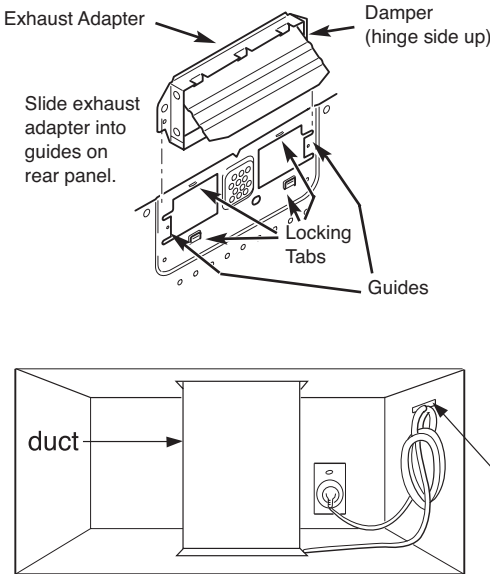
Problem	Cause	Solution
<p>Vent is not working</p> <ul style="list-style-type: none"> • Weak or no ventilation • Abnormal noise during operation • Product overheating 	<ol style="list-style-type: none"> 1. Improper blower unit direction or installation 2. Improper ductwork or damper connection 	<ol style="list-style-type: none"> 1. Check blower unit direction and reinstall if necessary. 2. Properly align the exhaust ports and blower plate opening. 3. Blower unit exhaust ports should be completely exposed to the outside 4. After installation, check the air ventilation path

The cost of repair or replacement under these excluded circumstances shall be borne by the consumer.

CUSTOMER INTERACTIVE CENTER NUMBERS

<p>To obtain Customer Assistance, Product Information, or Dealer or Authorized Service Center location:</p>	<p>Call 1-855-790-6655 (24 hours a day, 365 days per year) and select the appropriate option from the menu. Or visit our website at: www.thesignaturekitchen.com</p>
--	---



Customer Information Center

For inquires or comments, call;
1-855-790-6655 USA