

















ASSEMBLY INSTRUCTIONS

ITEM NO: B322-310 Stafford County 5/0 Q Headboard
 ITEM NO: B322-328 Stafford County 5/0 Q Storage FB & Slats
 ITEM NO: B322-330 Stafford County 5/0-6/6 Q/EK Side Rails

Thank you for purchasing this quality product. Be sure to check all packing material carefully for small parts, which may have come loose inside the carton during shipment. Identify and count all item and compare with the parts list and/or hardware list shown below.

PART LIST			
NO.	Description	Sketch	Quantity
1	Headboard		1pc
2	Right Headboard Leg		1pc
3	Left Headboard Leg		1pc
4	Footboard		1pc
5	Side Rail		2pcs
6	Long Slats Support Leg		5pcs
7	Bed Roll Out Slats		1set

HARDWARE			
NO.	Description	Sketch	Quantity
A	Ø5/16*2" Allen Bolt		6pcs
B	Ø5/16 Lock Washer		6pcs
C	Ø5/16*19mm Flat Washer		6pcs
D	4mm Allen Key		1pc
E	Ø4*30mm Screw		26pcs
F	Ø5/16*89mm Allen Bolt		8pcs
G	Ø5/16 Lock Washer		8pcs
H	Ø5/16 Flat Washer		8pcs
J	12 mm Lock Washer		1pc

Step 1

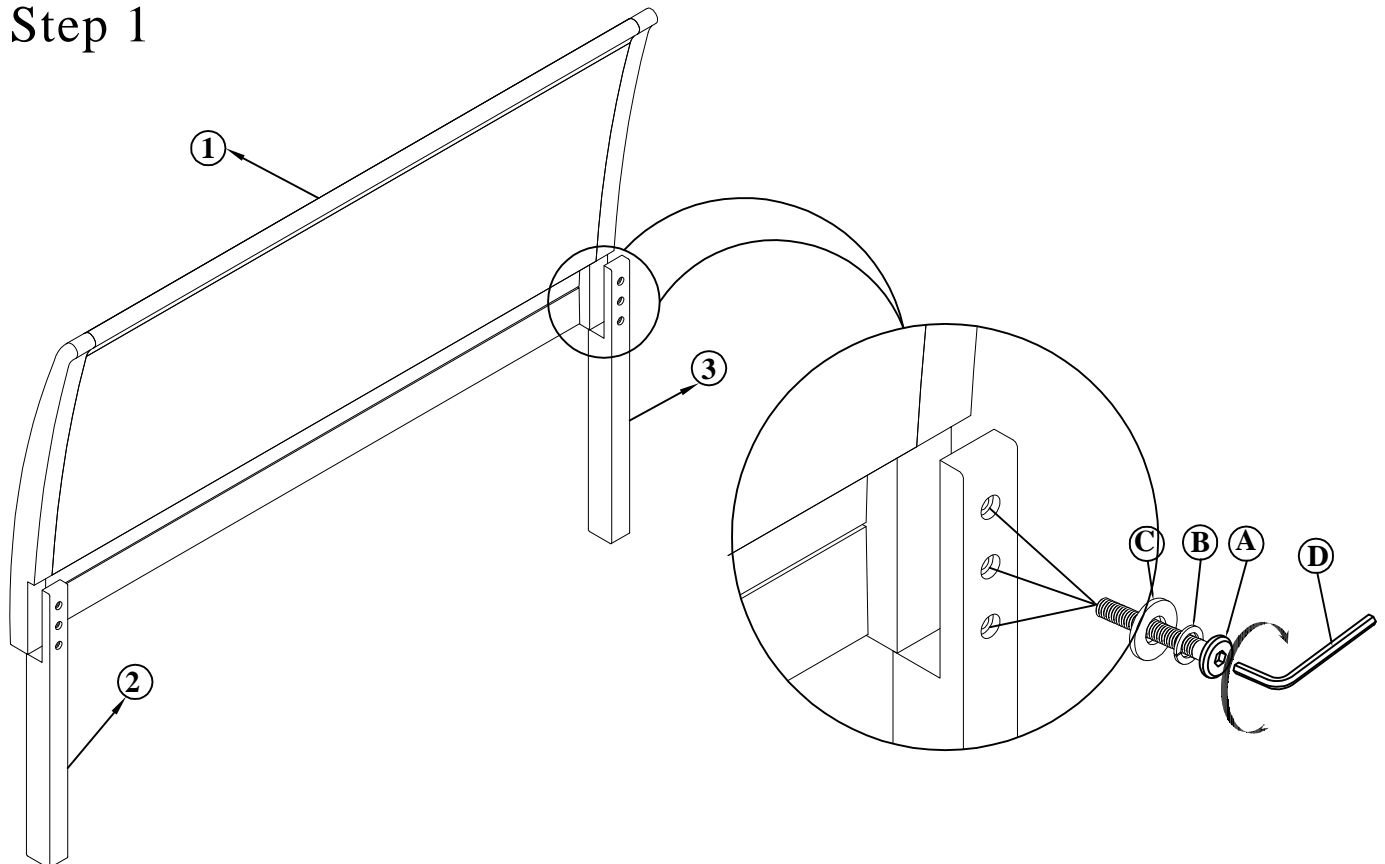

ASSEMBLY INSTRUCTIONS

ITEM NO: B322-310 Stafford County 5/0 Q Headboard
 ITEM NO: B322-328 Stafford County 5/0 Q Storage FB & Slats
 ITEM NO: B322-330 Stafford County 5/0-6/6 Q/EK Side Rails

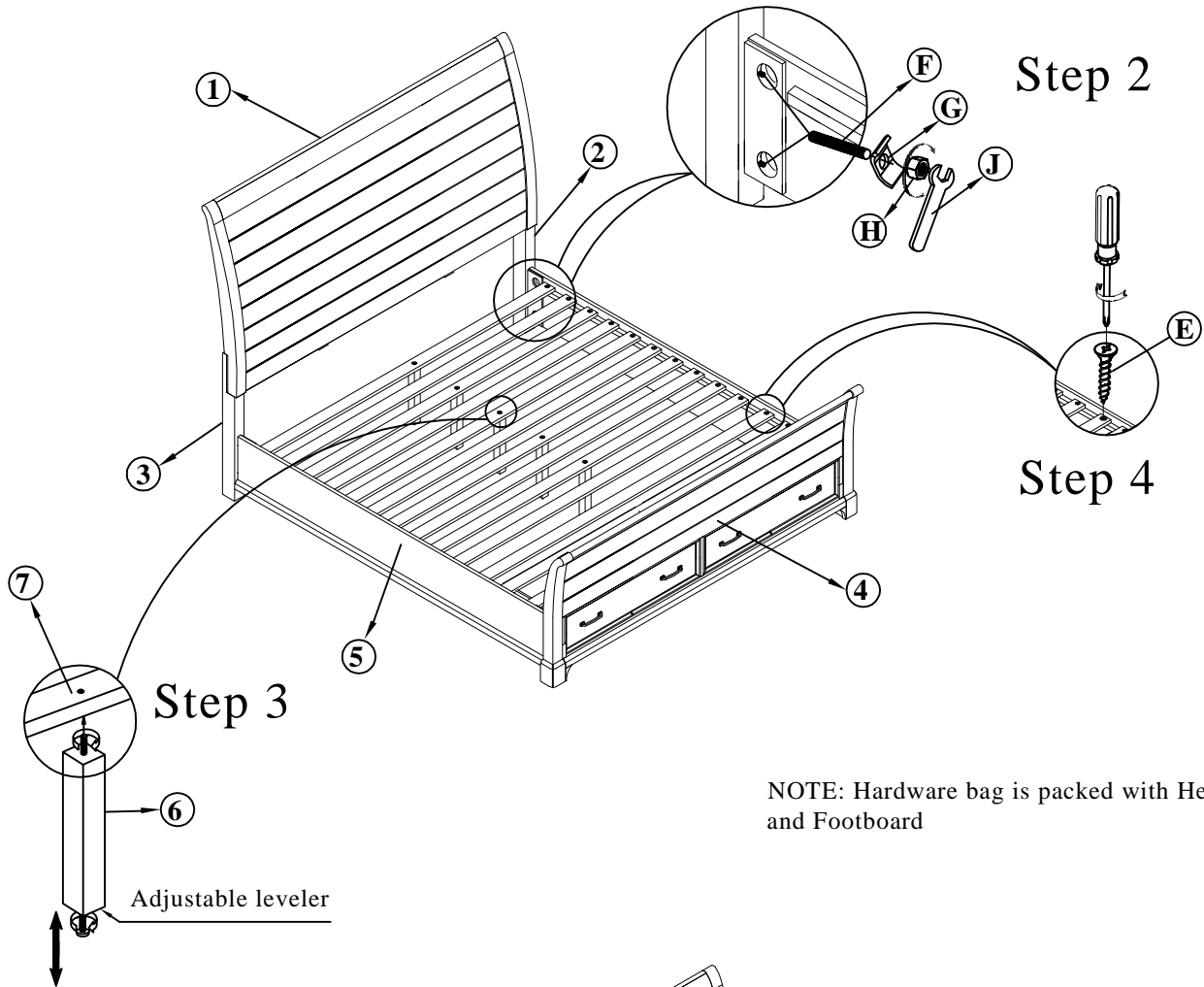

NOTE: Hardware bag is packed with Headboard and Footboard

