



E-Commerce by Enitial Lab

ASSEMBLY INSTRUCTIONS

MODEL #

CM6454 LOVE

Questions?

GIVE US CALL: 1-888-980-5122
MON-FRI 8:30AM - 5:30PM (PST)

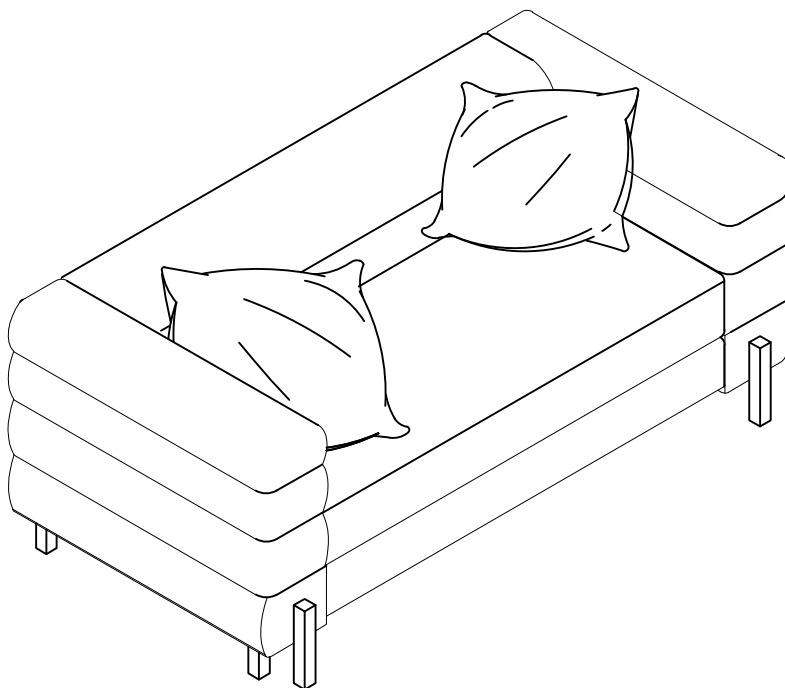

TOOLS REQUIRED



Allen Wrench

(Included)



Phillips
Screwdriver

(Not Included)

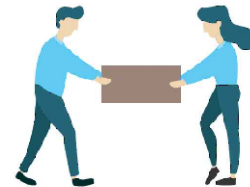

2 - People
Recommended

ASSEMBLY RATING



EASY ————— DIFFICULT

The Assembly Rating is a 5-point system showing the level of effort needed to assemble a specific product.

VERSION # 24-01-02





FOA Intro

Thank you for your purchase!

We hope you enjoy this new addition to your home for many years to come.

Our commitment to providing quality products does not simply end when you purchase our product. We fully stand behind our products from start to finish. Our customer service department is available Monday – Friday 8:30 AM – 5:30 PM Pacific and can help with assembly questions as well as, if necessary, replacing damaged or missing parts. To help expedite our service, please have these assembly instructions readily available, along with your order receipt.

 **Consumer Hotline**
Toll-Free 1-888-980-5122

 **Monday to Friday**
8:30AM- 5:30PM (PST)

 **WEBSITE**
www.foagroup.com

 **E-MAIL**
cs.ec@foagroup.com

 foagroup

 FurnitureOfAmerica

CHECK BEFORE STARTING

Are you missing anything?
Double-check all parts, hardware and accessories listed on Page 6 are accounted for.

Check out our Quick Tips!
We recommend reviewing the pre-assembly handouts. Even experts need a refresher now and then!

Should we send any replacements?
Are there any irregularities or flaws in the parts? We can send replacements!

Prep Time!
Please review the assembly instructions and all diagrams prior to assembling. Set up your work-space by laying the parts and hardware out separately, then begin!

PRE ASSEMBLY INTRODUCTION

We understand building ready-to-assemble furniture can be a challenging experience for some. To help avoid confusion, we have provided some helpful tips that may speed up the process.



Teamwork

ALWAYS have at least two people to help with transporting and assembling the product to avoid potential injury and/or damage.

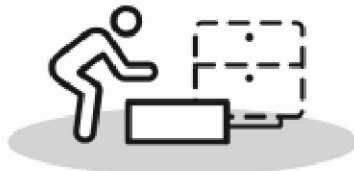

Suitable Location

Assembling near the area of the intended location is highly recommended.



Sufficient Space

Make sure you have enough space to move around during the assembly.

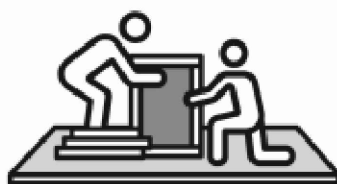

Avoid Scratches

Use cardboard, blankets or a carpeted area while assembling furniture to prevent scratches.

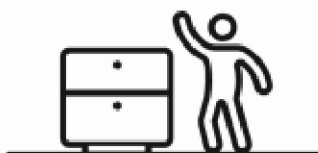

Flat Surface

Make sure the furniture rests on a flat and level surface with each leg evenly touching the floor.

ASSEMBLY AND CARE ADVICE



**FAILURE TO FOLLOW THE GUIDELINES BELOW MAY
RESULT IN INJURY AND/OR PROPERTY DAMAGE.**



Position each part correctly
and insert screws or bolts into
their respective holes.

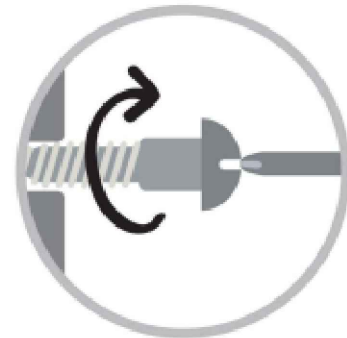

Turn clockwise to tighten and
only tighten when step is
completed or when instructed
to do so.



Use the appropriate hand tools
or power tools for assembly.
Select steps, such as tightening
screws and/or bolts, may require
hand tools to avoid causing
damage during assembly.



Save the instructions and store
any supplied tools for later
maintenance.

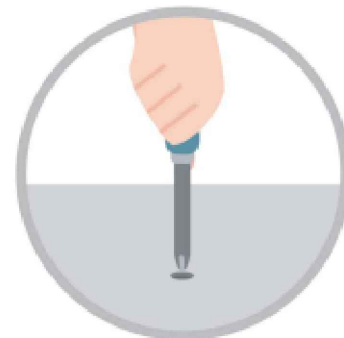

After two weeks, check and
tighten any loose hardware and
repeat again every six months
thereafter.

IT IS THE USER'S RESPONSIBILITY TO MAINTAIN THE FURNITURE. THE HARDWARE MAY LOOSEN OVER TIME AND MAY CAUSE THE FURNITURE TO BE WOBBLY AND UNABLE TO SUPPORT ITS INTENDED WEIGHT CAPACITY. THIS MAY LEAD TO COLLAPSE AND MAY CAUSE SERIOUS INJURY.

CM6454 LOVE



- Please keep instructions for future reference.
- Check the quantity and irregularity of parts and hardware before you start.

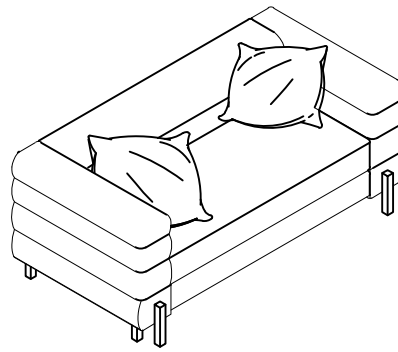

PART

#1 1pc

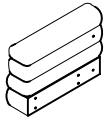

Left Arm Rest

#2 1pc

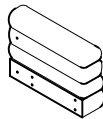

Right Arm Rest

#3 1pc

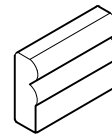

Sofa Back Rest

#4 1pc

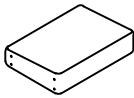

Sofa Seat

#5 1pc

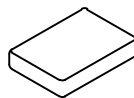

Seat Cushion

#6 4pcs



Metal Leg
(Left/Right)

#7 2pcs



Pillow

HARDWARE

#A 14pcs



Bolt Ø5/16"x1-1/2"

#B 26pcs



Spring Washer

#C 26pcs



Flat Washer

#D 1pc









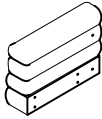
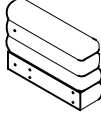
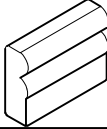

Allen Key

#E 12pcs

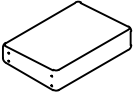
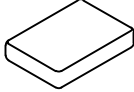

Bolt Ø5/16"x1"

CM6454-Love is packed in 2 cases

Carton	Disignation	Part		Hardware
CM6454-ARM	Left Arm Rest	#1		
	Right Arm Rest	#2		
CM6454-L	Sofa Back Rest	#3		 #A 14pcs  #B 26pcs  #C 26pcs  #D 1pc  #E 12pcs
	Sofa Seat	#4		
	Seat Cushion	#5		
	Metal Leg (Left/Right)	#6		
	Seat Cushion	#7		

Exploded View

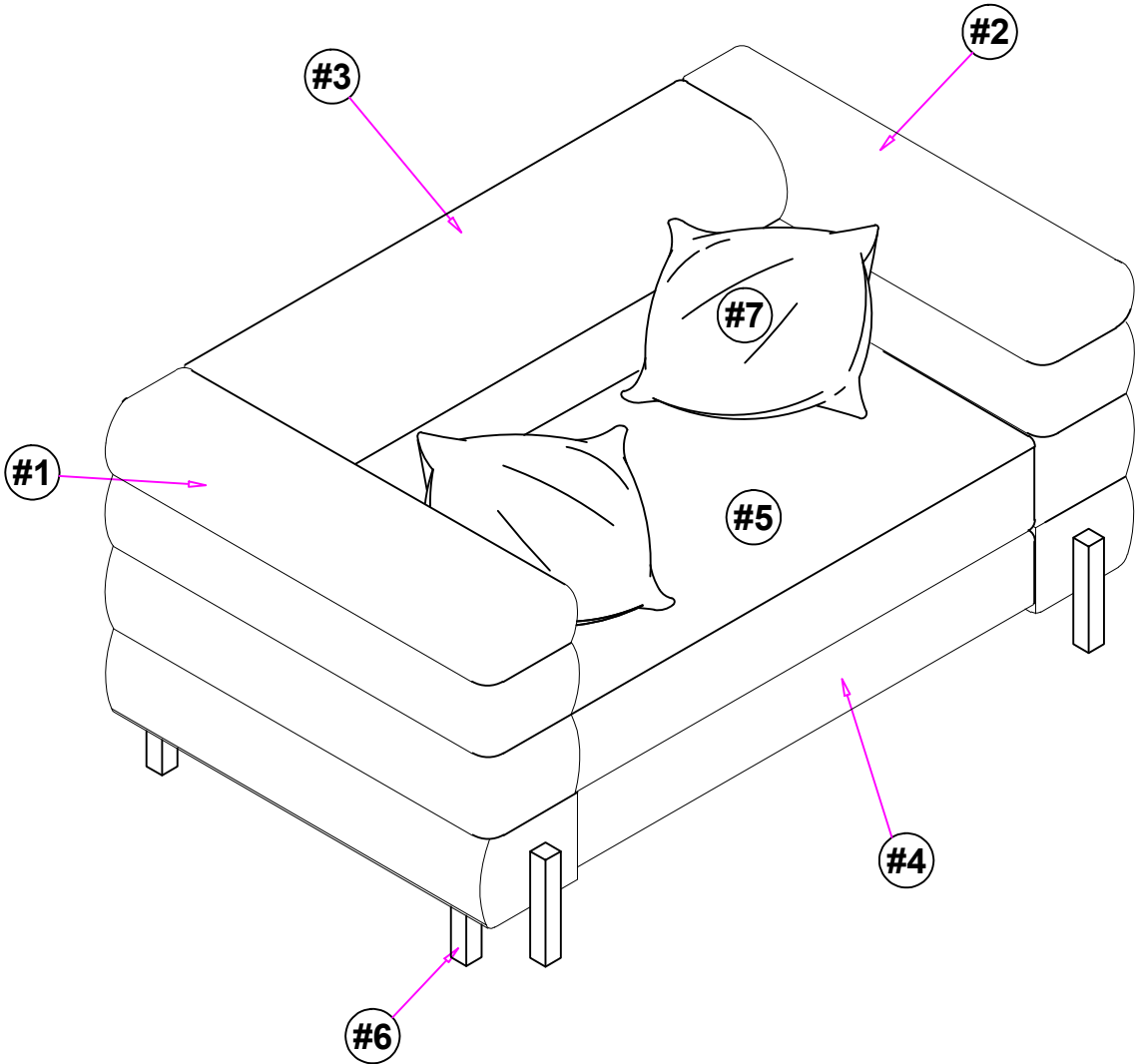

ASSEMBLY INSTRUCTIONS

1

Part #3 x1pc

Part #4 x1pc

Hardware #A x2 pcs

Hardware #B x2 pcs

Hardware #C x2 pcs

Hardware #D x1 pc

Attach the Sofa Seat (#4) to the Sofa back rest (#3) by using Bolt (#A) with Spring Washer (#B) and Flat washer (#C).

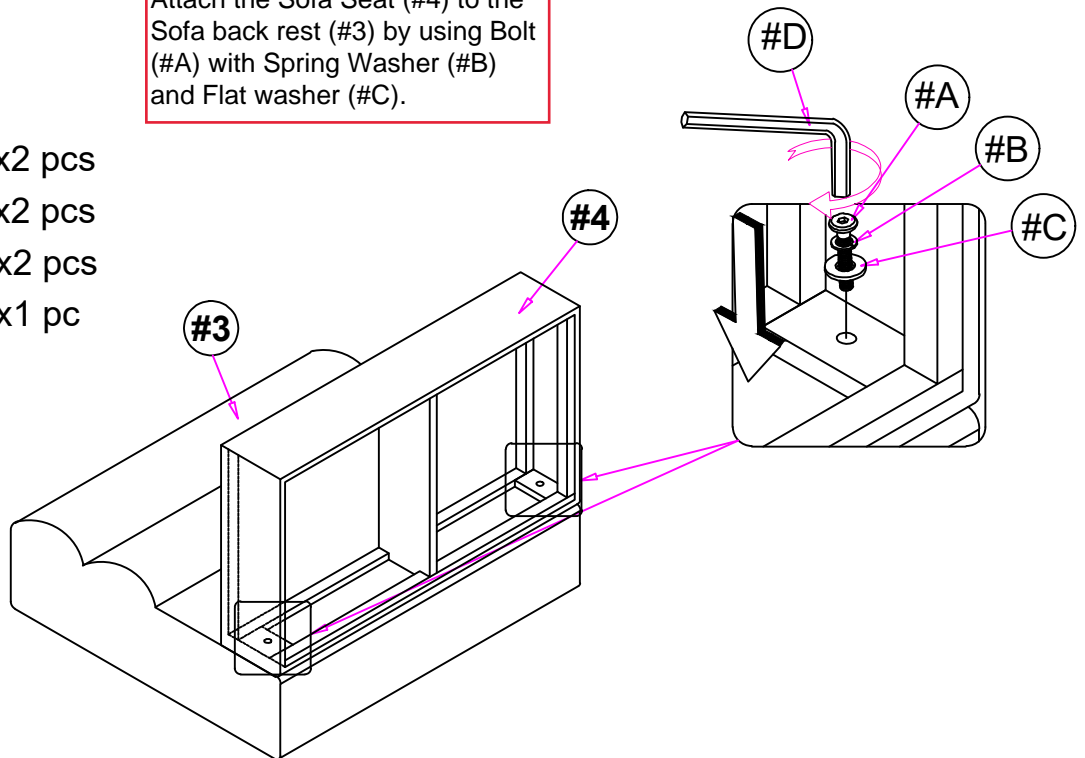

2

Part #1 x1pc

Part #2 x1pc

Part #3 x1pc

Part #4 x1pc

Hardware #A x8 pcs

Hardware #B x8 pcs

Hardware #C x8 pcs

Hardware #D x1 pc

Align the Left arm rest (#1) and Right arm rest (#2) to the Sofa seat (#4) and secure by using Bolt (#A) with Spring washer (#B) and Flat washer (#C).

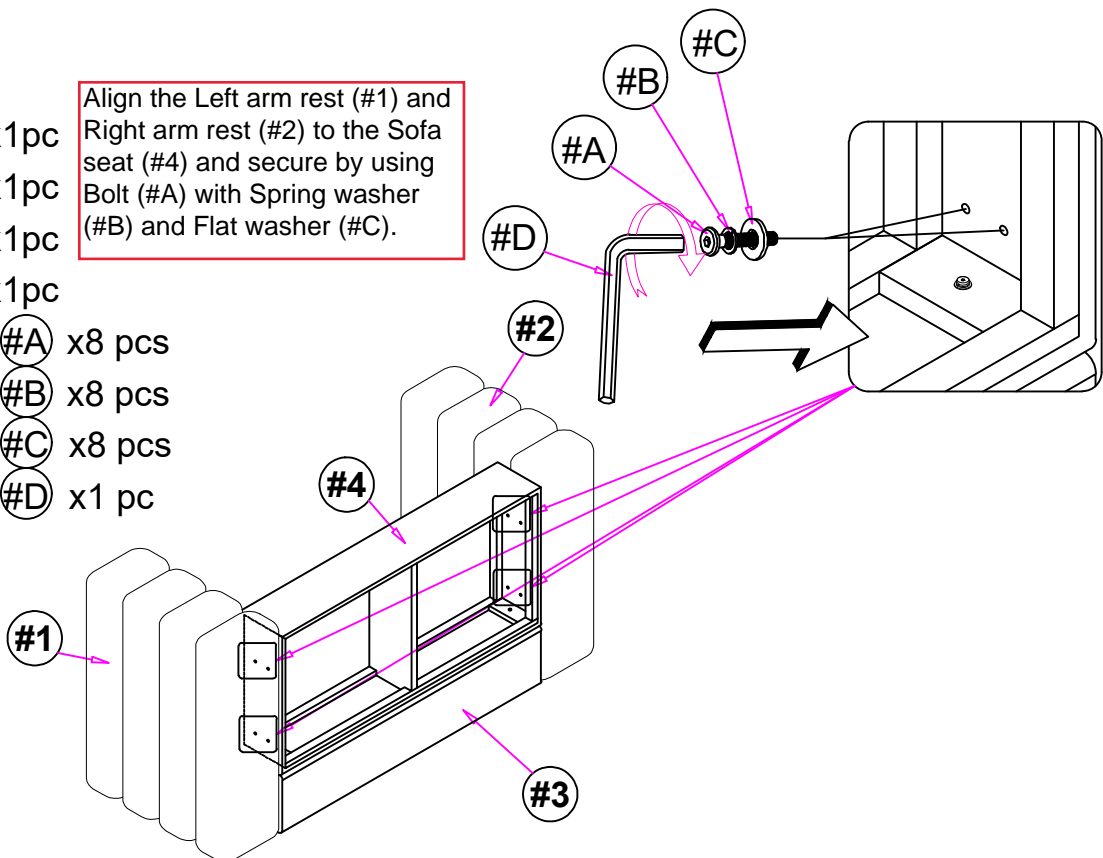

ASSEMBLY INSTRUCTIONS

3

- Part #1 x1pc
- Part #2 x1pc
- Part #3 x1pc
- Part #4 x1pc
- Hardware #A x4 pcs
- Hardware #B x4 pcs
- Hardware #C x4 pcs
- Hardware #D x1 pc

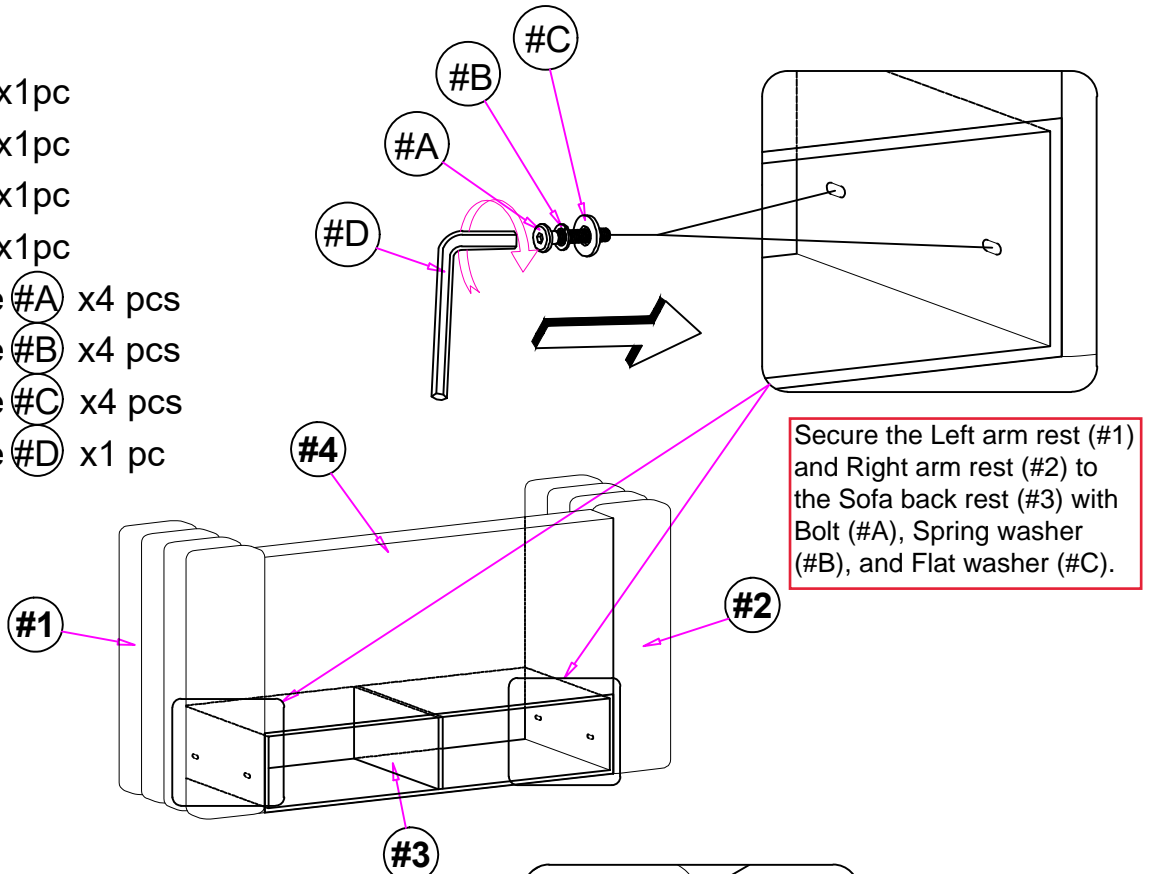

4

- Part #1 x1pc
- Part #2 x1pc
- Part #3 x1pc
- Part #4 x1pc
- Part #6 x4pcs
- Hardware #B x12 pcs
- Hardware #C x12 pcs
- Hardware #D x1 pc
- Hardware #E x12 pc

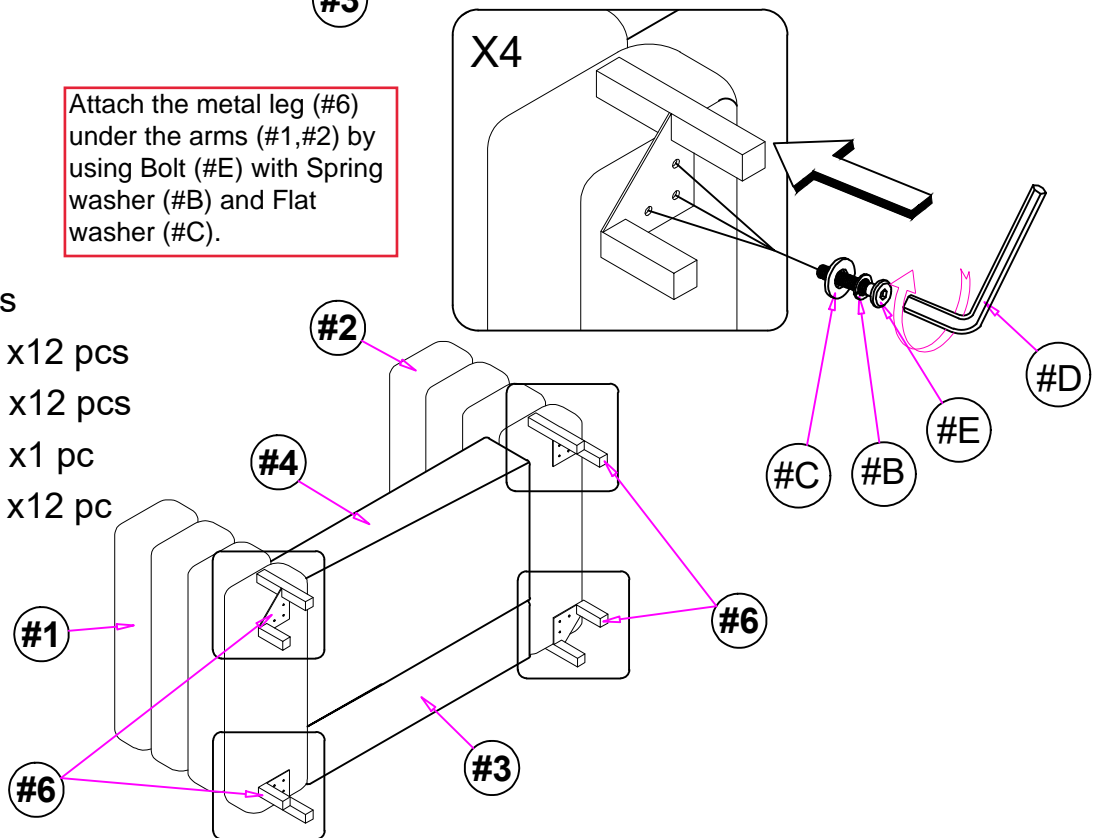

ASSEMBLY INSTRUCTIONS

5

- Part #1 x1pc
- Part #2 x1pc
- Part #3 x1pc
- Part #4 x1pc
- Part #5 x1pc
- Part #6 x4pcs

Place Seat cushion (#5) in center.

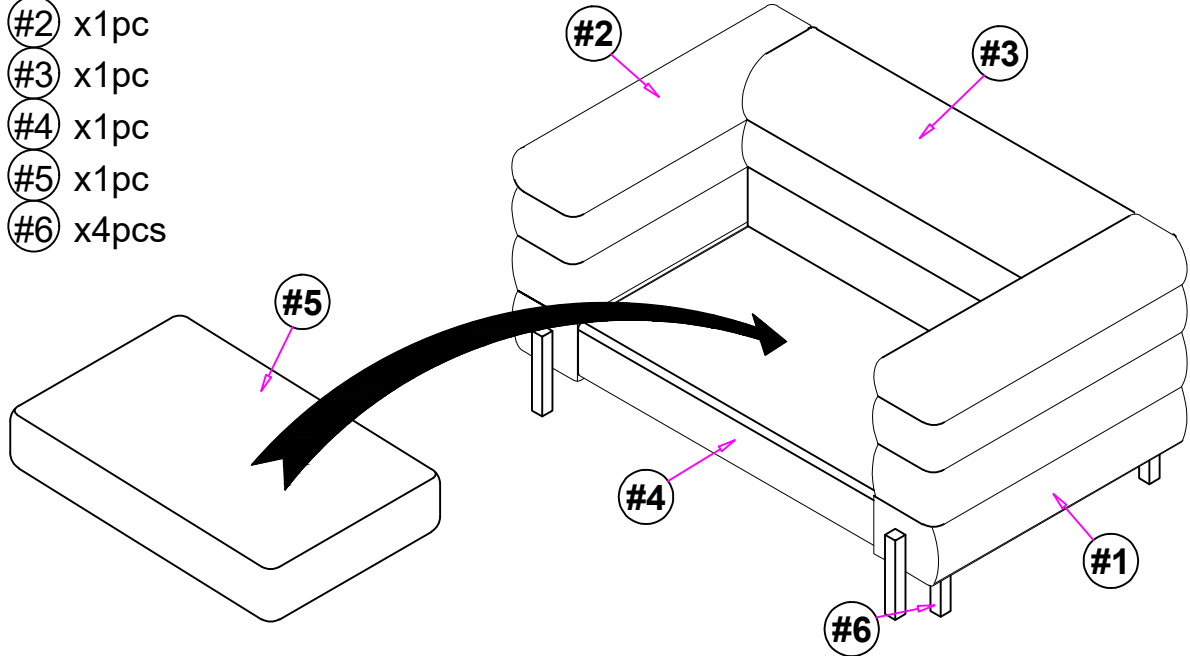

6

- Part #1 x1pc
- Part #2 x1pc
- Part #3 x1pc
- Part #4 x1pc
- Part #5 x1pc
- Part #6 x4pcs
- Part #7 x2pcs

Place Pillow (#7) .

