

600 CFM Integral Blower



Product Features



Notes: Please refer to installation instructions. Installation instructions are available at www.thermador.com. Specifications are correct at the time of printing. Thermador reserves the right to change product specifications and design at any time, without notice.

1 800 735 4328 | WWW.THERMADOR.COM | 1901 Main Street, Suite 600 Irvine, CA 92614

©2019 BSH HOME APPLIANCES CORPORATION, ALL RIGHTS RESERVED LITHO DATE: 01/2019

600 CFM Integral Blower

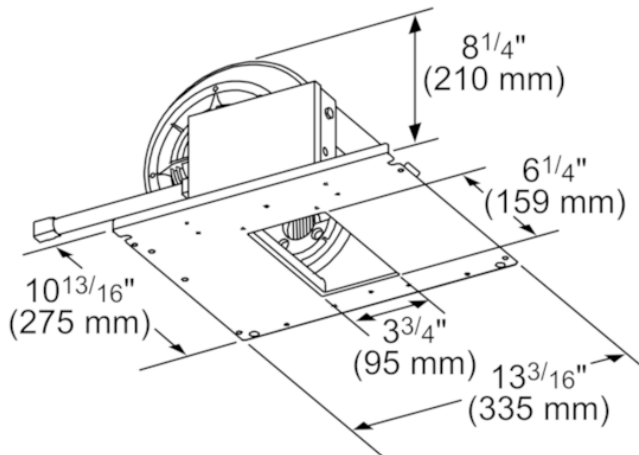

measurements in inches (mm)

Product Features

Product group	Accessory
Brand	Thermador
SKU	VTN630W
Internal article number	VTN630W
EAN code	825225934738
Product packaging dimensions (HxWxD) (in)	12 1/8" x 13 3/8" x 19 7/8"
Net weight (lbs)	11
Gross weight (lbs)	13
UPC code	825225934738
Name of product image	MCSA02216228_i7490_1621980_VTN630W_PAK

Technical Specification

Notes: Please refer to installation instructions. Installation instructions are available at www.thermador.com. Specifications are correct at the time of printing. Thermador reserves the right to change product specifications and design at any time, without notice.

1 800 735 4328 | WWW.THERMADOR.COM | 1901 Main Street, Suite 600 Irvine, CA 92614

©2019 BSH HOME APPLIANCES CORPORATION, ALL RIGHTS RESERVED LITHO DATE: 01/2019