

27" Speed Oven

800 Series – Stainless Steel HMC87152UC



HMC87152UC
Stainless Steel

The speed oven pairs the cooking qualities of a conventional oven with the speed of microwave technology.

Features & Benefits

SpeedChef® cooking cycles offer faster cooking times for your convenience.

Flush install matches Bosch wall oven, steam oven, or warming drawer.

2-in-1 microwave and convection oven for a variety of cooking options.

Electrical connection – 120 Volt NEMA 5-20 three prong plug.

LED lights

General Properties

Cavity material	Stainless steel
Max. microwave power	1,000 W

Capacity

Cavity capacity	1.6 cu. ft.
Turntable diameter	14 1/8"

Technical Details

Watts	1,920 W
Circuit breaker	20 A
Volts	120 V
Frequency	60 Hz
Power cord length	43"
Plug type	NEMA 5-20 – 3 prong plug



Dimensions & Weight

Overall appliance dimensions (HxWxD)	19 5/8" x 26 3/4" x 22 3/8"
Required cutout size (HxWxD)	(Standard) 19 1/4" x 25 1/2" x 22"
	(Flush) 20 1/8" x 27" x 23 1/2"
Oven overall interior dimensions (HxWxD)	9 7/8" x 16 1/2" x 16 1/2"
Turntable – Metal Max. Cookware	12 3/4" dia.
Turntable – Ceramic Max. Cookware	12 1/2" dia.
Rack – Rectangular Cookware Max.	15" x 12"
Net weight	92 lbs

Accessories—Included

Included	Metal turntable, cooking rack, ceramic cooking tray
----------	---

*To be fully ADA compliant, these units must be installed according to ADA guidelines. Please check current ADA requirements for guidance on installation.

Accessories: To purchase Bosch accessories, cleaners & parts please visit www.bosch-home.com/us/store or call 1-800-944-2904 (Mon to Fri 5 am to 6 pm PST, Sat 6 am to 3 pm PST).

Notes: All height, width and depth dimensions are shown in inches. BSH reserves the absolute and unrestricted right to change product materials and specifications, at any time, without notice. Consult the product's installation instructions for final dimensional data and other details prior to making cutout.

Warranties: Please see Use & Care manual or Bosch website for statement of limited warranty.

For more information on our entire line of products, go to www.bosch-home.com/us or call 1-800-944-2904

© BSH Home Appliances Corporation. All rights reserved. Bosch is a registered trademark of Robert Bosch GmbH.

27" Speed Oven

800 Series – Stainless Steel HMC87152UC



Installation Details

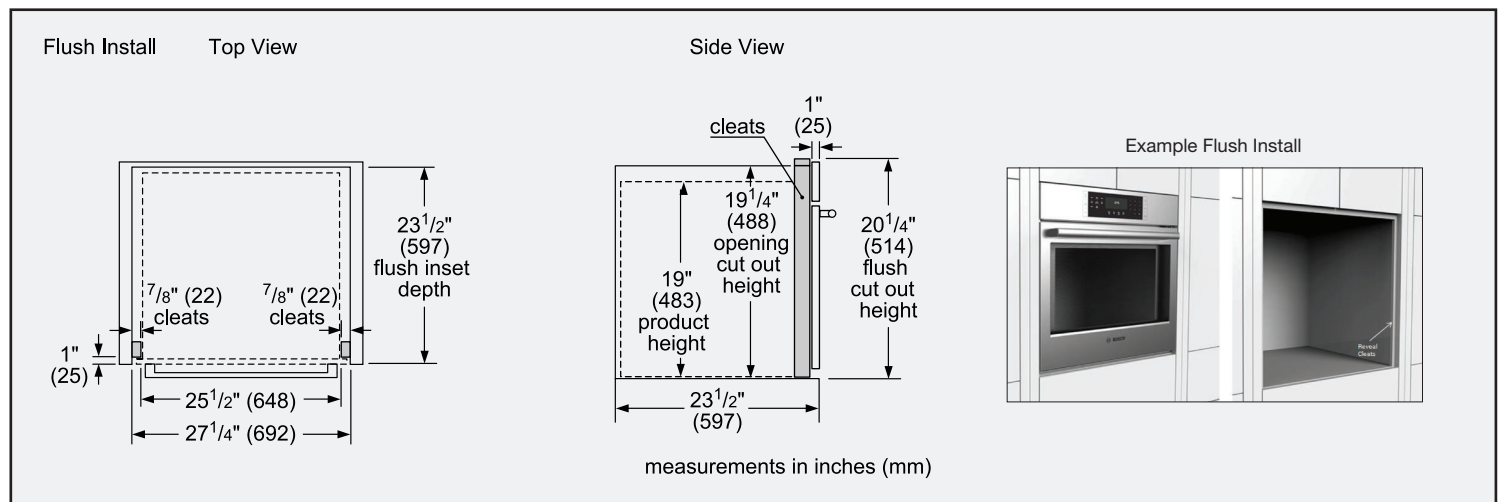
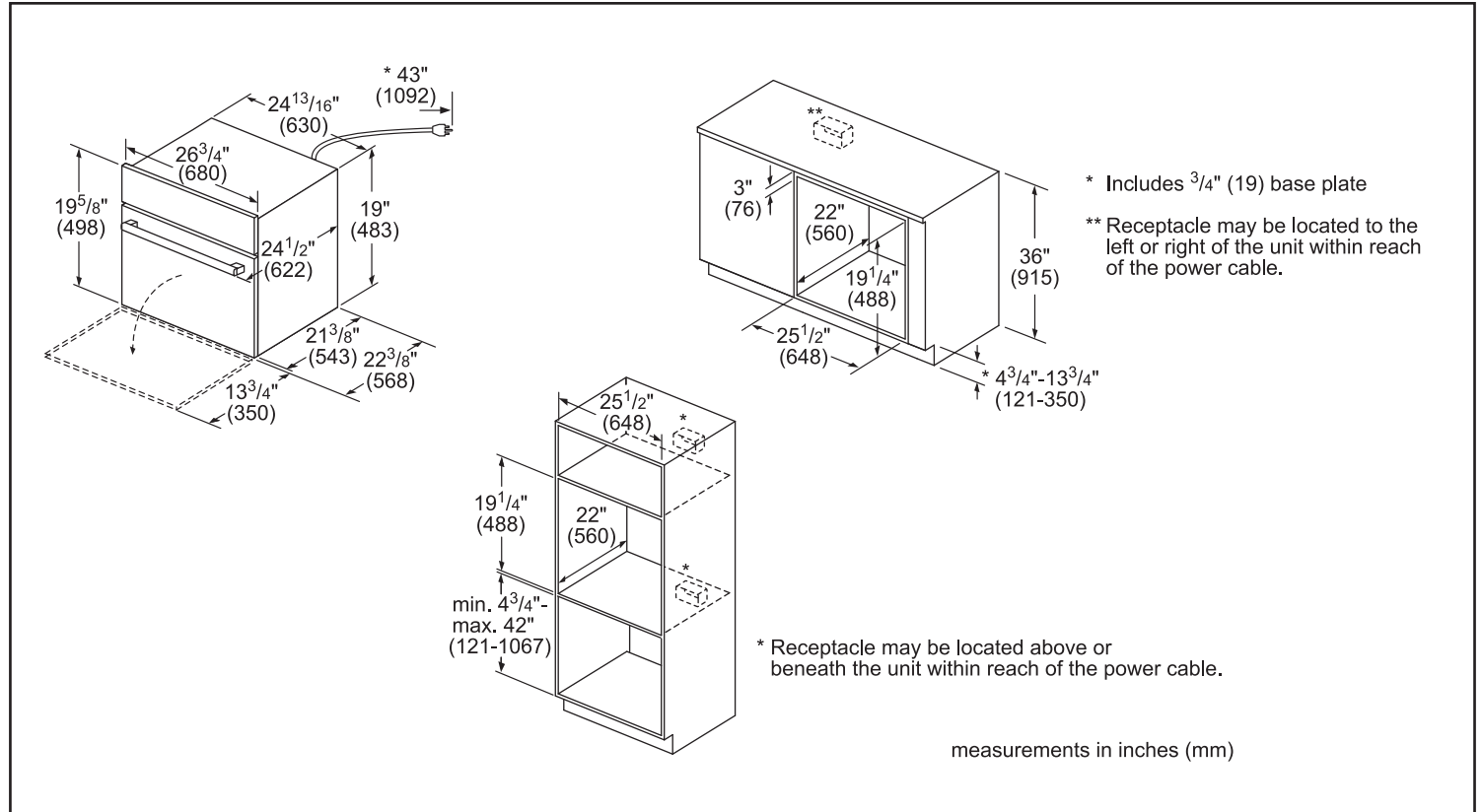

Accessories: To purchase Bosch accessories, cleaners & parts please visit www.bosch-home.com/us/store or call 1-800-944-2904 (Mon to Fri 5 am to 6 pm PST, Sat 6 am to 3 pm PST).

Notes: All height, width and depth dimensions are shown in inches. BSH reserves the absolute and unrestricted right to change product materials and specifications, at any time, without notice. Consult the product's installation instructions for final dimensional data and other details prior to making cutout.

Warranties: Please see Use & Care manual or Bosch website for statement of limited warranty.

For more information on our entire line of products, go to www.bosch-home.com/us or call 1-800-944-2904

© BSH Home Appliances Corporation. All rights reserved. Bosch is a registered trademark of Robert Bosch GmbH.

27" Speed Oven

800 Series – Stainless Steel HMC87152UC



BOSCH
Invented for life

Installation Details

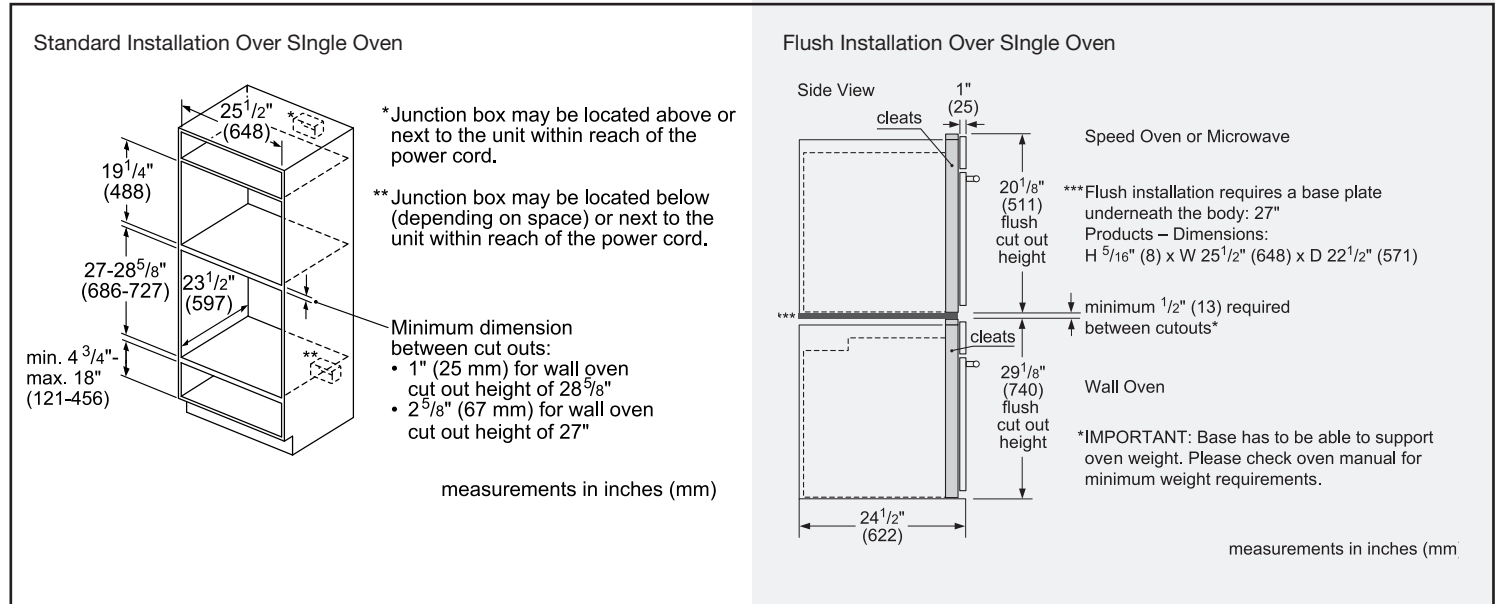

Accessories: To purchase Bosch accessories, cleaners & parts please visit www.bosch-home.com/us/store or call 1-800-944-2904 (Mon to Fri 5 am to 6 pm PST, Sat 6 am to 3 pm PST).

Notes: All height, width and depth dimensions are shown in inches. BSH reserves the absolute and unrestricted right to change product materials and specifications, at any time, without notice. Consult the product's installation instructions for final dimensional data and other details prior to making cutout.

Warranties: Please see Use & Care manual or Bosch website for statement of limited warranty.

For more information on our entire line of products, go to www.bosch-home.com/us or call 1-800-944-2904

© BSH Home Appliances Corporation. All rights reserved. Bosch is a registered trademark of Robert Bosch GmbH.