

# SAMSUNG

# Product Guide

## 3400 Series Laundry

WA45T3400AW – Washer

DVE45T3400W – Electric Dryer

DVG45T3400W – Gas Dryer



# Table of Contents

## WA45T3400AW – Top Load Washer

### Product Overview

Product Overview 4

Carousel Image Order 5

### Product Messaging

Features and Benefits 7

### Product Specs

Related Products 11

Spec Sheet 12

Energy Guide and User Manual 13

**Feature Icons 15**

## DVE45T3400W – Top Load Electric Dryer

## DVG45T3400W – Top Load Gas Dryer

### Product Overview

Product Overview 17

Carousel Image Order 18

### Product Messaging

Features and Benefits 20

### Product Specs

Related Products 24

Spec Sheet 25

User Manual 26

**Feature Icons 28**

# Product Overview

---

**WA45T3400AW – 4.5 cu. ft. Capacity Top Load Washer  
with Active WaterJet**

# Product Overview

## Product Title

4.5 cu. ft. Capacity Top Load Washer with Active WaterJet

## Product Short Description (136 Characters)

Samsung's Top Load washer is equipped with Active WaterJet to help pretreat clothes and Vibration Reduction Technology+ to reduce noise.

## Product Long Description (275 Characters)

Samsung's Large 4.5 cu. ft. Capacity Top Load washer fits more in every load and cuts down on laundry time. It is equipped with Active WaterJet that lets you pretreat heavily soiled and stained clothes and Vibration Reduction Technology+ that reduces noise for quiet washing.

## Available Color



### White

Model Number: WA45T3400AW

UPC: 887276440392

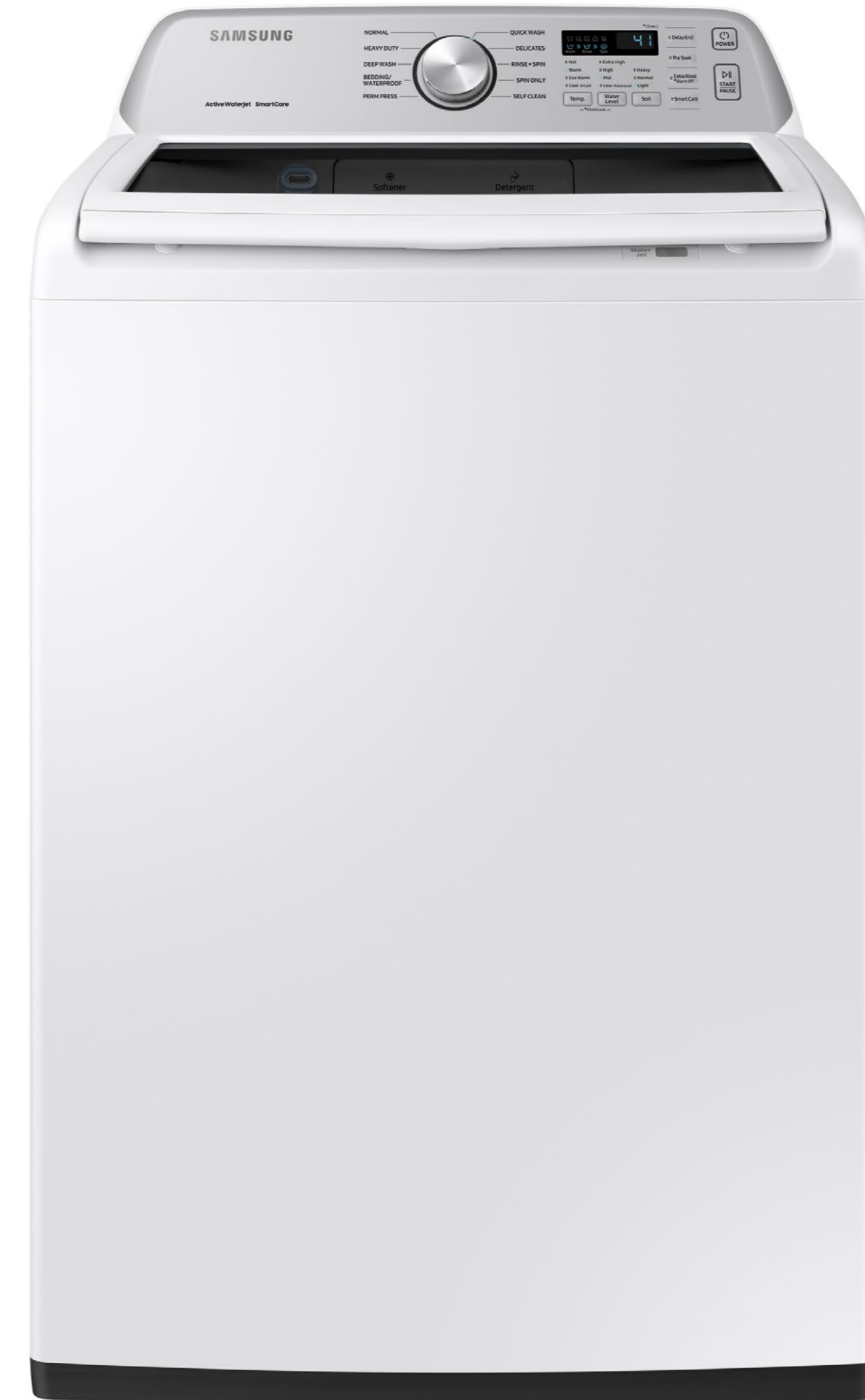

# Carousel Image Order

Easy Ads links



Retail.com: <http://www.samsungeasyads.com/mm/nicePath/easyads?nav=pr659311631>  
Samsung.com: <http://www.samsungeasyads.com/mm/nicePath/easyads?nav=pr659311633>





# Product Messaging

---



**WA45T3400AW – 4.5 cu. ft. Capacity Top Load Washer  
with Active WaterJet**

Features and Benefits – WA45T3400AW				
Headline	Feature Name	Long Body Copy	Short Body Copy	Associated Image
Fit more for fewer loads	Large 4.5 cu. ft. Capacity	Fewer loads, less time in the laundry room, and more time doing the things you love.	Fewer loads, less time in the laundry room.	
Pretreat with a push of a button	Active WaterJet	A built-in water faucet lets you easily pretreat soiled or heavily stained clothes with a press of a button. Scrub items right inside your washer, no laundry room sink needed.	Built-in water faucet lets you easily pretreat heavily soiled and stained clothes.	
Quiet washing anytime, any place	Vibration Reduction Technology+	Do your laundry without disturbing anyone at any time and in any place. Innovative Vibration Reduction Technology+ reduces noise and vibration for quiet washing.	Reduces noise and vibration.	

## Features and Benefits – WA45T3400AW (Continued)

Headline	Feature Name	Long Body Copy	Short Body Copy	Associated Image
<p><b>Keep your washer fresh and clean</b></p>	<p><b>Self Clean</b></p>	<p>Keep your washer fresh and clean with Self Clean technology, which eliminates dirt and bacteria that can form in any washer tub. Self Clean will notify you every twenty wash cycles when it is time for a cleaning.</p>	<p>Eliminates dirt and bacteria to keep your washer fresh and clean.</p>	
<p><b>Extra water when you need it most</b></p>	<p><b>Extra High Water Level</b></p>	<p>Ensure that all of your items are thoroughly soaked by selecting Extra High Water Level before starting your laundry.</p>	<p>Extra High Water Level thoroughly soaks all of your items.</p>	
<p><b>Soft-Close Lid</b></p>	<p>N/A</p>	<p>The premium Soft-Close Lid keeps you and your family protected by closing safely, gently and quietly.</p>	<p>Soft-Close Lid closes safely, gently and quietly.</p>	



Features and Benefits – WA45T3400AW (Continued)				
Headline	Feature Name	Long Body Copy	Short Body Copy	Associated Image
Easy to troubleshoot	Smart Care	<p>Easy troubleshooting from the convenience of your smartphone.* Smart Care interacts with your washer and dryer to perform an immediate diagnosis and offer quick solutions.</p> <p>*Requires Samsung Smart Washer/Dryer App. The Samsung Smart Washer/Dryer App supports Android OS 2.3.6 or later and iOS 3 or later for iPhone models. Smart Washer/Dryer App available in App Store and Play Store.</p>	<p>Easy troubleshooting from the convenience of your smartphone.*</p> <p>*Requires Samsung Smart Washer/Dryer App. The Samsung Smart Washer/Dryer App supports Android OS 2.3.6 or later and iOS 3 or later for iPhone models. Smart Washer/Dryer App available in App Store and Play Store.</p>	
Diamond Drum Design	N/A	<p>The diamond drum interior helps extend clothing life by treating fabrics gently. Small water holes help prevent fabrics from snagging and being damaged, allowing fabric care with deep-clean results.</p>	<p>The diamond drum interior helps extend clothing life by treating fabrics gently.</p>	

# Product Specs

---

**WA45T3400AW – 4.5 cu. ft. Capacity Top Load Washer  
with Active WaterJet**

## Related Products

### Dryer Series

DVE45T3400W  
DVG45T3400W

# Spec Sheet

## Easy Ads link

<http://www.samsungeasyads.com/mm/nicePath/easyads?nav=pr659311739>

## WA45T3400AW

Samsung 4.5 cu. ft. Capacity Top Load Washer with Active WaterJet



**Signature Features**

**Large 4.5 cu. ft. Capacity**

- Fewer loads, less time in the laundry room, and more time doing the things you love.

**Active WaterJet**

- Built-in water faucet lets you easily pretreat heavily soiled and stained clothes with a press of a button.

**Vibration Reduction Technology+**

- Reduces noise and vibration for extra quiet washing.

**SAMSUNG**

**Available Color**

White



Large 4.5 cu. ft. Capacity
Active WaterJet

---

**Features**

- Large 4.5 cu. ft. Capacity
- Active WaterJet
- Vibration Reduction Technology+
- Self Clean
- Smart Care\*
- Diamond Drum Interior
- Soft-Close Lid
- 700 RPM Maximum Spin Speed
- AC Motor
- 10 Preset Washing Cycles
- 6 Additional Washing Options
- 5 Temperature Levels
- LED Display: Ice Blue

**Convenience**

- Child Lock
- Dispenser Trays: Main Wash, Softener, Bleach

**Rating**

IMEF = 1.57  
IWF = 6.5  
240 kWh/yr

**Electrical Requirement:**

120V / 60Hz  
15 Amps

\*Requires Samsung Smart Washer/Dryer App. The Samsung Smart Washer/Dryer app supports Android OS 2.3.6 or later and iOS 3 or later for iPhone models. Smart Washer/Dryer app available in App Store and Play Store.

## WA45T3400AW

Samsung 4.5 cu. ft. Capacity Top Load Washer with Active WaterJet

**Installation Specifications**

Alcove or closet installation

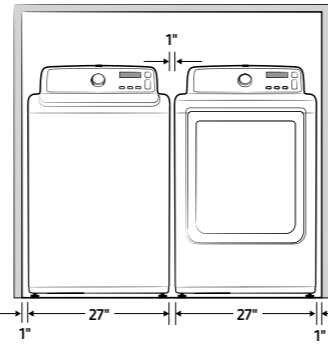

Side View Confined

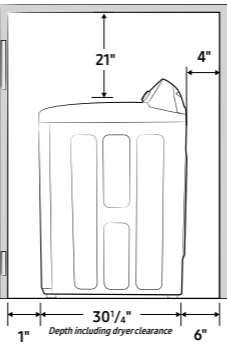

**Minimum clearances for closets and alcoves:**

Sides – 1”  
Top – 21”  
Rear – 5 3/4”  
Closet Front – 1”

If both the washer and a dryer are installed in the same location, the front of the alcove or closet must have two unobstructed air openings for a combined minimum total area of 72-inch<sup>2</sup>. This clearance requirement is applicable for washers only.

For dryer's clearance requirement, see the dryer's user manual.

**Dimensions**

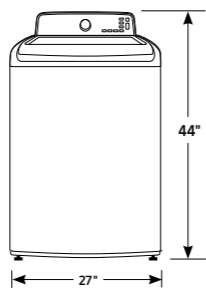
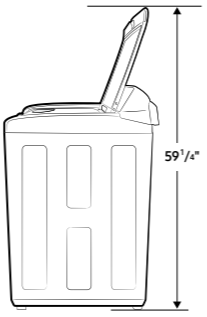
**SAMSUNG**

**10 Preset Washing Cycles:**  
Normal, Bedding/Waterproof, Heavy Duty, Permanent Press, Delicates, Quick Wash, Self Clean, Rinse and Spin, Spin Only, Deep Wash

**6 Additional Washing Options:**  
Delay End, Presoak, Extra Rinse, Sound On/Off, Child Lock, Smart Care

**5 Temperature Levels:**  
Hot, Warm, Eco Warm, Cool, Cold

**3 Soil Levels:**  
Heavy, Normal, Light

**Dispenser Trays:**  
Main Wash, Softener, Bleach

**Warranty**  
One (1) Year Parts and Labor  
Three (3) Years Stainless Steel Tub (Part Only)  
Five (5) Years AC Motor (Part Only)

**Product Dimensions & Weight (WxHxD)**  
Dimensions: 27" x 44" x 29 5/16"  
Weight: 134.5 lbs

**Shipping Dimensions & Weight (WxHxD)**  
Dimensions: 29 7/16" x 46 7/16" x 31"  
Weight: 145.5 lbs

Color	Model #	UPC Code
White	WA45T3400AW	887276440392

**Matching Dryer (Electric/Gas)**

White	DVE45T3400W	887276439617
White	DVG45T3400W	887276439624

Actual color may vary. Design, specifications, and color availability are subject to change without notice. Non-metric weights and measurements are approximate.  
©2020 Samsung Electronics America, Inc. 85 Challenger Road, Ridgefield Park, NJ 07660. Tel: 800-SAMSUNG, samsung.com. Samsung is a registered trademark of Samsung Electronics Co. Ltd.

Washer Spec Sheet - front

Washer Spec Sheet - back

# Energy Guide and User Manual

Easy Ads link

<http://www.samsungeasyads.com/mm/nicePath/easyads?nav=pr659311739>

U.S. Government Federal law prohibits removal of this label before consumer purchase.

# ENERGYGUIDE

Clothes Washer Capacity Class: Standard Samsung Models WA45T32\*\*A\* WA45T34\*\*A\* Capacity (tub volume): 4.5 cubic feet

**Compare ONLY to other labels with yellow numbers.**  
Labels with yellow numbers are based on the same test procedures.

**Estimated Yearly Energy Cost**  
(when used with an electric water heater)

**\$29**

\$8 Cost Range of Similar Models \$51

**240 kWh**  
Estimated Yearly Electricity Use

**\$18**  
Estimated Yearly Energy Cost  
(when used with a natural gas water heater)

- Your cost will depend on your utility rates and use.
- Cost range based only on standard capacity models.
- Estimated energy cost based on six wash loads a week and a national average electricity cost of 12 cents per kWh and natural gas cost of \$1.09 per therm.

[ftc.gov/energy](http://ftc.gov/energy)

Energy Guide

**Washer**

**User manual**  
WA45T3400\*\*

**SAMSUNG**

User Manual

# Feature Icons

---

**WA45T3400AW – 4.5 cu. ft. Capacity Top Load Washer  
with Active WaterJet**

# Feature Icons

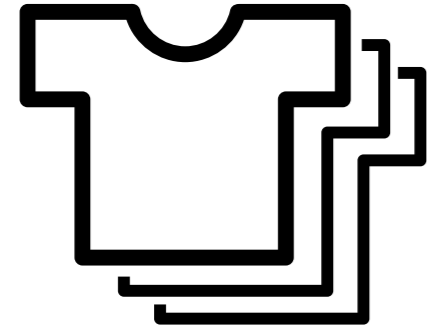

Large 4.5 cu. ft.  
Capacity



Active WaterJet



Vibration Reduction  
Technology+

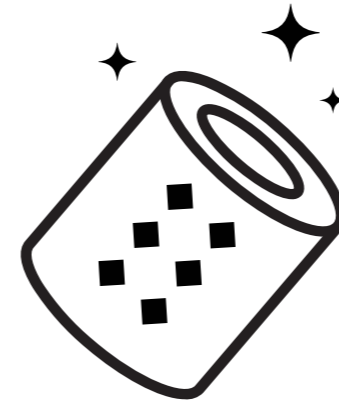

Self Clean

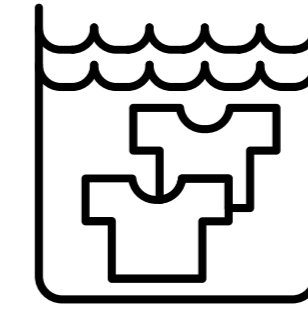

Extra High  
Water Level

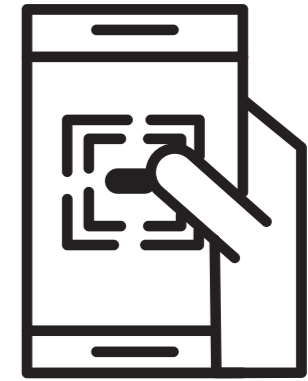

Smart Care

# Product Overview

---

**DVE45T3400W & DVG45T3400W - Large 7.4 cu. ft. Capacity  
Top Load Dryer with Sensor Dry**



# Product Overview

## Product Title

Large 7.4 cu. ft. Capacity Top Load Dryer with Sensor Dry

## Product Short Description (126 Characters)

Samsung's 7.4 cu. ft. capacity dryers feature Sensor Dry and 10 Preset Drying Cycles, so you can do fewer loads in less time.

## Product Long Description (248 Characters)

Samsung's Large 7.4 cu. ft. Capacity Top Load dryer fits more in every load, cutting down on laundry time. It features Sensor Dry that helps prevent overdrying for optimal fabric care, and has 10 Preset Drying Cycles to best suit your drying needs.

## Available Color



### White

Model Number: DVE45T3400W

UPC: 887276439617

Model Number: DVG45T3400W

UPC: 887276439624



# Carousel Image Order

Easy Ads links

Retail.com: <http://www.samsungeasyads.com/mm/nicePath/easyads?nav=pr659297211>  
Samsung.com: <http://www.samsungeasyads.com/mm/nicePath/easyads?nav=pr659297403>

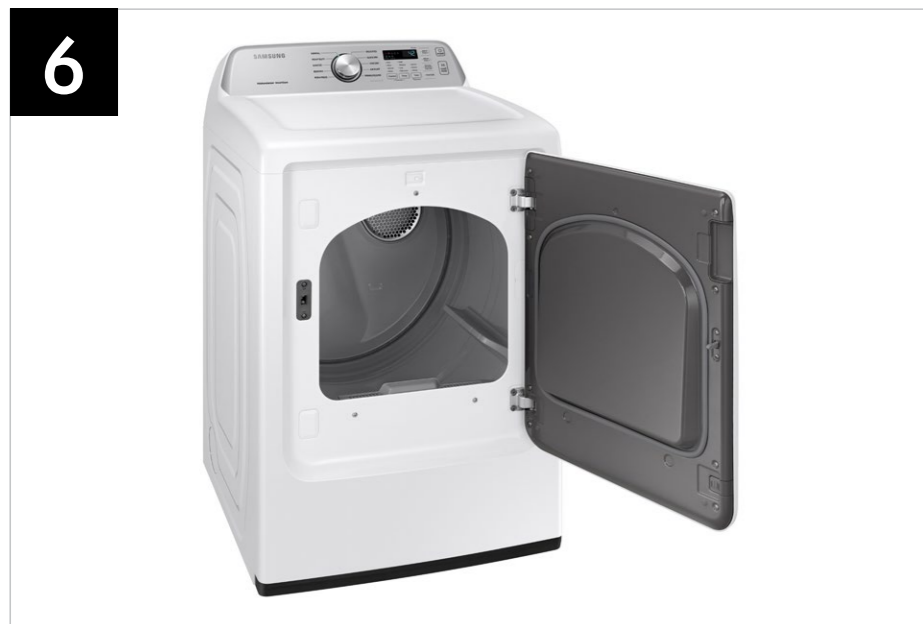



# Product Messaging



---

**DVE45T3400W & DVG45T3400W - Large 7.4 cu. ft. Capacity  
Top Load Dryer with Sensor Dry**

## Features and Benefits – DVE(G)45T3400W

Headline	Feature Name	Long Body Copy	Short Body Copy	Associated Image
<p><b>Worry-free drying</b></p>	<p><b>Sensor Dry</b></p>	<p>Automatically optimizes the time and temperature of your drying cycle to protect your clothes from heat damage, while avoiding excess energy use.*</p> <p>*The Sensor Dry icon turns on when in use.</p>	<p>Helps prevent over-drying for optimal fabric care.*</p> <p>*The Sensor Dry icon turns on when in use.</p>	
<p><b>Fit more for fewer loads</b></p>	<p><b>Large 7.4 cu. ft. Capacity</b></p>	<p>Fewer loads, less time in the laundry room and more time doing the things you love.</p>	<p>Fewer loads, less time in the laundry room.</p>	
<p><b>10 Preset Drying Cycles</b></p>	<p>N/A</p>	<p>More cycles to cover almost every drying need for your active family.</p>	<p>More cycles to best suit your drying needs.</p>	

## Features and Benefits – DVE(G)45T3400W (Continued)

Headline	Feature Name	Long Body Copy	Short Body Copy	Associated Image
<p><b>Easy to troubleshoot</b></p>	<p><b>Smart Care</b></p>	<p>Easy troubleshooting from the convenience of your smartphone.* Smart Care interacts with your washer and dryer to perform an immediate diagnosis and offer quick solutions.</p> <p><small>*Requires Samsung Smart Washer/Dryer App. The Samsung Smart Washer/Dryer App supports Android OS 2.3.6 or later and iOS 3 or later for iPhone models. Smart Washer/Dryer App available in App Store and Play Store.</small></p>	<p>Easy troubleshooting from the convenience of your smartphone.*</p> <p><small>*Requires Samsung Smart Washer/Dryer App. The Samsung Smart Washer/Dryer App supports Android OS 2.3.6 or later and iOS 3 or later for iPhone models. Smart Washer/Dryer App available in App Store and Play Store.</small></p>	 <p>The image shows two Samsung DVE(G)45T3400W units. A hand is holding a smartphone displaying the Samsung Smart Washer/Dryer app interface, which includes a 'Recognize Smart Care' screen with a red and green status indicator.</p>
<p><b>Flexible opening</b></p>	<p><b>Reversible Dryer Door</b></p>	<p>Choose the direction your dryer door opens to better suit your laundry room layout.</p>	<p>Choose the direction your dryer door opens.</p>	 <p>The image shows the Samsung DVE(G)45T3400W unit with its dryer door open, demonstrating its flexibility. A vertical line is drawn through the center of the unit to indicate the reversible door mechanism.</p>
<p><b>Stop the fluff</b></p>	<p><b>Lint Filter Indicator</b></p>	<p>Stop worrying about lint or fluff building-up and blocking your dryer's air intake. The Filter Check Indicator light on the control panel will provide you with a helpful reminder when it is time to clean the filter, so your dryer maintains optimal performance.</p>	<p>The Filter Check Indicator light lets you know when it is time to clean the filter.</p>	 <p>The image shows the control panel of the Samsung DVE(G)45T3400W unit with a blue circular icon labeled 'Lint filter indicator' overlaid on it. Next to it is the lint filter tray, which is partially open, showing the filter inside.</p>

Features and Benefits – DVE(G)45T3400W (Continued)				
Headline	Feature Name	Long Body Copy	Short Body Copy	Associated Image
<b>7 Additional Drying Options</b>	N/A	Seven convenient drying options provide optimal care for all fabric types to keep clothes looking their best.	Further options to provide optimal care for all fabric types.	N/A
<b>4 Temperature Levels</b>	N/A	Choose from High, Medium, Low and Extra Low temperature levels to dry your clothes gently and thoroughly.	Ideal temperatures to dry your clothes gently and thoroughly.	N/A

# Product Specs

---

**DVE45T3400W & DVG45T3400W - Large 7.4 cu. ft. Capacity  
Top Load Dryer with Sensor Dry**

## Related Products

Washer Series	Dryer Vent Kit
WA45T3400AW	DV-2A



# Spec Sheets

Easy Ads link

<http://www.samsungeasyads.com/mm/nicePath/easyads?nav=pr659339751>

## DVE45T3400W

Samsung 7.4 cu. ft. Capacity Top Load Electric Dryer



**SAMSUNG**

**Signature Features**

**Sensor Dry**

- Helps prevent overdrying for optimal fabric care.

**Large 7.4 cu. ft. Capacity**

- Fewer loads, less time in the laundry room, and more time doing the things you love.

**10 Preset Drying Cycles**

- More cycles to cover almost every drying need for your active family.

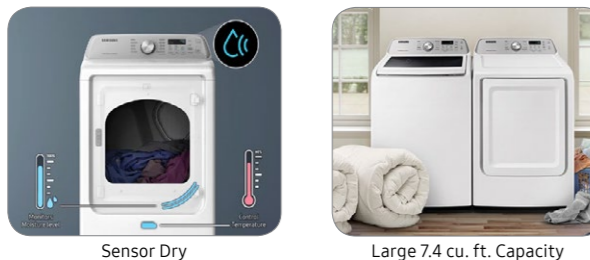

**Available Color**

White

**Features**

- Sensor Dry
- Large 7.4 cu. ft. Capacity
- 10 Preset Drying Cycles
- Reversible Dryer Door
- Smart Care\*
- 7 Additional Drying Options
- 4 Temperature Levels
- Wrinkle Prevent
- 4-Way Venting
- Powder Coat Interior
- LED Display: Ice Blue

**Convenience**

- Child Lock
- Filter Check Indicator

**Rating**

644 kWh/yr

**Electrical Requirement:**

120V / 240V / 60Hz  
30 Amps

\*Requires Samsung Smart Washer/Dryer App. The Samsung Smart Washer/Dryer app supports Android OS 2.3.6 or later and iOS 5 or later for iPhone models. Smart Washer/Dryer app available in App Store and Play Store.

## DVE45T3400W

Samsung 7.4 cu. ft. Capacity Top Load Electric Dryer

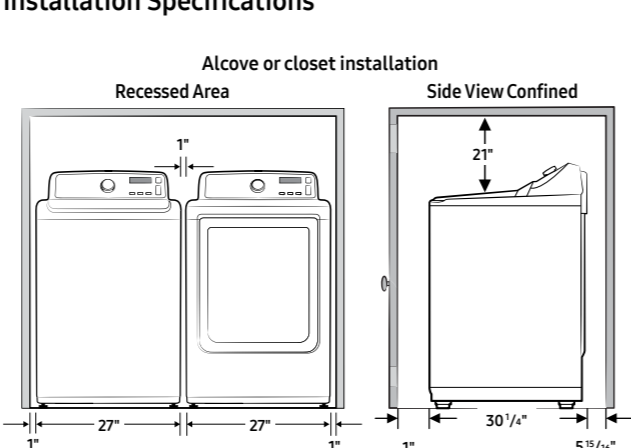

**SAMSUNG**

**Installation Specifications**

Alcove or closet installation

Recessed Area

Side View Confined

**4-Way Venting**

**10 Preset Drying Cycles:**  
Normal, Heavy Duty, Permanent Press, Bedding, Delicates, Sanitize, Time Dry, Air Fluff, Quick Dry, Wrinkle Release

**7 Additional Drying Options:**  
Mixed Load Bell, Wrinkle Prevent, Adjust Time (Up), Adjust Time (Down), Child Lock, Sound On/Off, Smart Care

**4 Temperature Levels:**  
High, Medium, Low, Extra Low

**4 Dry Levels:**  
Very Dry, More Dry, Normal Dry, Damp Dry

**Warranty**  
One (1) Year Parts and Labor

**Product Dimensions & Weight (WxHxD)**  
Dimensions: 27" x 44" x 30 1/4"  
Weight: 110.2 lbs

**Shipping Dimensions & Weight (WxHxD)**  
Dimensions: 29 1/8" x 46 7/8" x 31 1/8"  
Weight: 119.0 lbs

Electric	Model #	UPC Code
White	DVE45T3400W	887276439617
White	DVG45T3400W	887276439624
<b>Matching Washer</b>		
White	WA45T3400AW	887276440392
<b>Accessories</b>		
Vent Kit	DV-2A	887276146416

If both the washer and a dryer are installed in the same location, the front of the alcove or closet must have two unobstructed air openings for a combined minimum total area of 72-inch<sup>2</sup>. This clearance requirement is applicable for washer and dryer pair installation.

For washer's clearance requirement, see the washer's user manual.

**Dimensions**

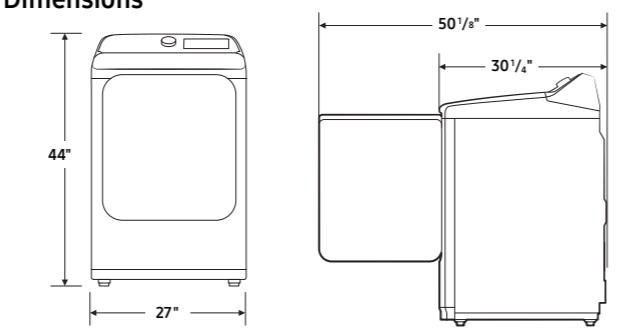

	Recommended	Use only for short-run installation
Weather hood type		
	4"	2.5"
Number of 90° elbows		
0	80 ft.	74 ft.
1	68 ft.	62 ft.
2	57 ft.	51 ft.
3	47 ft.	41 ft.

Actual color may vary. Design, specifications, and color availability are subject to change without notice. Non-metric weights and measurements are approximate.  
©2020 Samsung Electronics America, Inc. 85 Challenger Road, Ridgefield Park, NJ 07660. Tel: 800-SAMSUNG. samsung.com. Samsung is a registered trademark of Samsung Electronics Co., Ltd.

Electric Dryer Spec Sheet - back

## DVG45T3400W

Samsung 7.4 cu. ft. Capacity Top Load Electric Dryer



**SAMSUNG**

**Signature Features**

**Sensor Dry**

- Helps prevent overdrying for optimal fabric care.

**Large 7.4 cu. ft. Capacity**

- Fewer loads, less time in the laundry room, and more time doing the things you love.

**10 Preset Drying Cycles**

- More cycles to cover almost every drying need for your active family.



**Available Color**

White

**Features**

- Sensor Dry
- Large 7.4 cu. ft. Capacity
- 10 Preset Drying Cycles
- Reversible Dryer Door
- Smart Care\*
- 7 Additional Drying Options
- 4 Temperature Levels
- Wrinkle Prevent
- 3-Way Venting
- Powder Coat Interior
- LED Display: Ice Blue

**Convenience**

- Child Lock
- Filter Check Indicator

**Rating**

644 kWh/yr

**Electrical Requirement:**

120V / 60Hz  
15 Amps

\*Requires Samsung Smart Washer/Dryer App. The Samsung Smart Washer/Dryer app supports Android OS 2.3.6 or later and iOS 5 or later for iPhone models. Smart Washer/Dryer app available in App Store and Play Store.

Gas Dryer Spec Sheet - front

## DVG45T3400W

Samsung 7.4 cu. ft. Capacity Top Load Electric Dryer

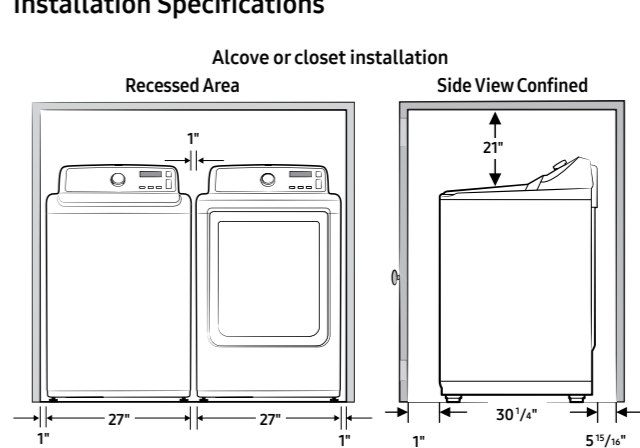

**SAMSUNG**

**Installation Specifications**

Alcove or closet installation

Recessed Area

Side View Confined

**3-Way Venting**

**10 Preset Drying Cycles:**  
Normal, Heavy Duty, Permanent Press, Bedding, Delicates, Sanitize, Time Dry, Air Fluff, Quick Dry, Wrinkle Release

**7 Additional Drying Options:**  
Mixed Load Bell, Wrinkle Prevent, Adjust Time (Up), Adjust Time (Down), Child Lock, Sound On/Off, Smart Care

**4 Temperature Levels:**  
High, Medium, Low, Extra Low

**4 Dry Levels:**  
Very Dry, More Dry, Normal Dry, Damp Dry

**Warranty**  
One (1) Year Parts and Labor

**Product Dimensions & Weight (WxHxD)**  
Dimensions: 27" x 44" x 30 1/4"  
Weight: 110.2 lbs

**Shipping Dimensions & Weight (WxHxD)**  
Dimensions: 29 1/8" x 46 7/8" x 31 1/8"  
Weight: 119.0 lbs

Gas	Model #	UPC Code
White	DVG45T3400W	887276439624
White	DVE45T3400W	887276439617
<b>Matching Washer</b>		
White	WA45T3400AW	887276440392
<b>Accessories</b>		
Vent Kit	DV-2A	887276146416

If both the washer and a dryer are installed in the same location, the front of the alcove or closet must have two unobstructed air openings for a combined minimum total area of 72-inch<sup>2</sup>. This clearance requirement is applicable for washer and dryer pair installation.

For washer's clearance requirement, see the washer's user manual.

**Dimensions**

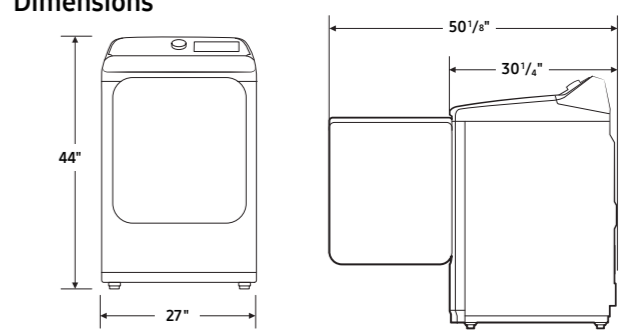

	Recommended	Use only for short-run installation
Weather hood type		
	4"	2.5"
Number of 90° elbows		
0	80 ft.	74 ft.
1	68 ft.	62 ft.
2	57 ft.	51 ft.
3	47 ft.	41 ft.

Actual color may vary. Design, specifications, and color availability are subject to change without notice. Non-metric weights and measurements are approximate.  
©2020 Samsung Electronics America, Inc. 85 Challenger Road, Ridgefield Park, NJ 07660. Tel: 800-SAMSUNG. samsung.com. Samsung is a registered trademark of Samsung Electronics Co., Ltd.

Gas Dryer Spec Sheet - back

# User Manual

## Easy Ads link

<http://www.samsungeasyads.com/mm/nicePath/easyads?nav=pr659339751>

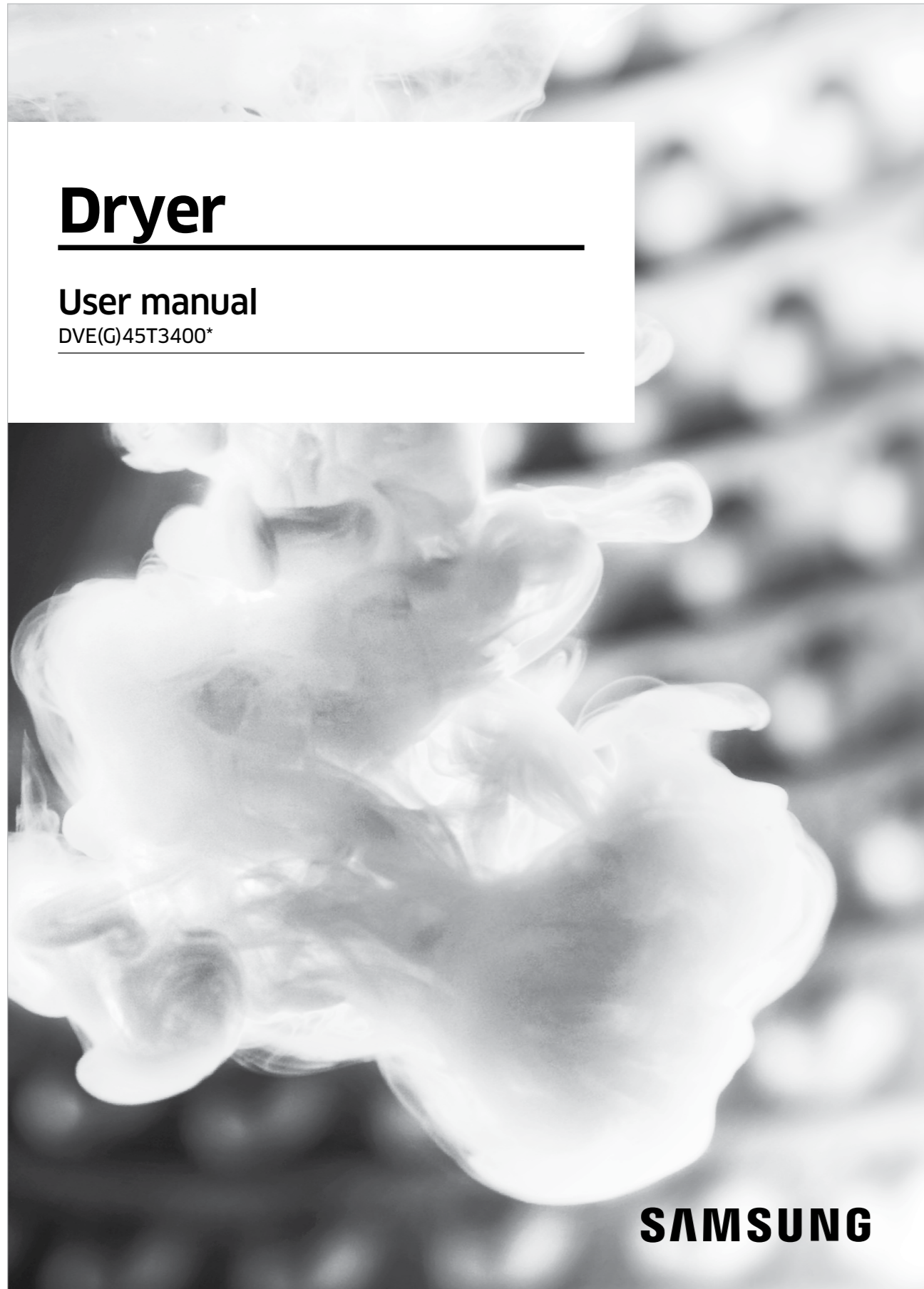

User Manual

# Feature Icons

---

**DVE45T3400W & DVG45T3400W - Large 7.4 cu. ft. Capacity  
Top Load Dryer with Sensor Dry**

# Feature Icons

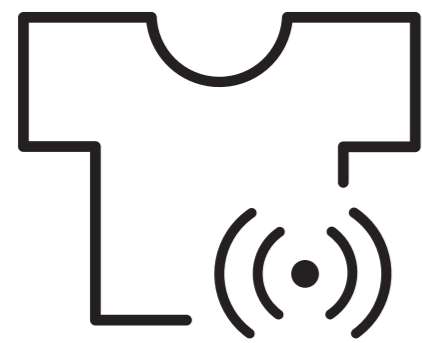

Sensor Dry

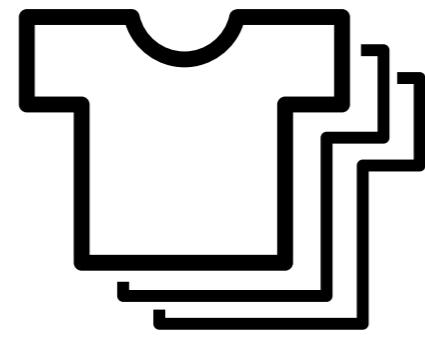

Large 7.4 cu. ft.  
Capacity

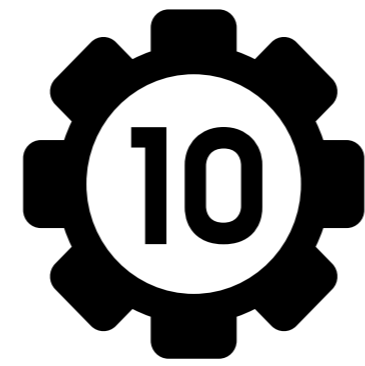

10 Preset Drying Cycles

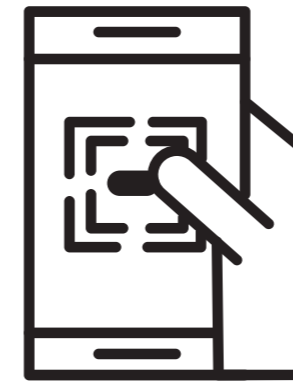

Smart Care

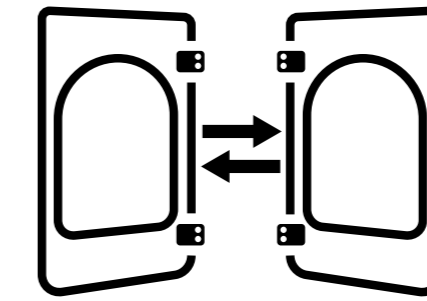

Reversible Dryer Door

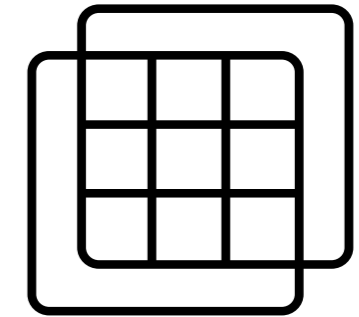

Lint Filter  
Indicator

**SAMSUNG**