

## Operating Instructions 36 Inch Dual Fuel Range (electric oven and gas cooktop)

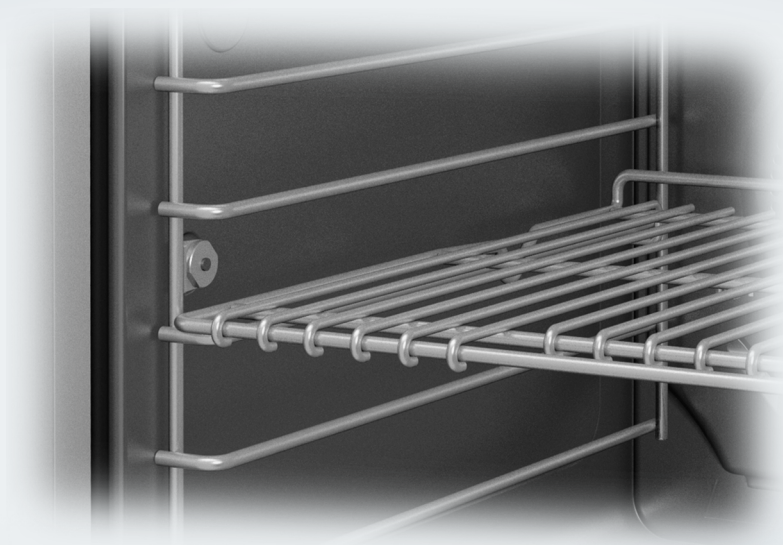

To prevent accidents and damage to the range, you **must** read all instructions supplied before installing or using the appliance.

# IMPORTANT SAFETY INSTRUCTIONS

## WARNING

Children and adults can tip over the range if has not been secured. This may lead to fatal injuries.

- ▶ This range must be secured and connected using the anti-tip device according to the installation instructions.
- ▶ If you have moved the range, slide the locking latch onto the anti-tip device until you feel it lock into place.
- ▶ Do not use the range if the anti-tip device has not been properly installed and engaged.
- ▶ Failure to observe the information contained in the installation instructions can lead to serious or fatal injuries for children and adults.

	<b> WARNING</b>
	<p>All ranges can tip</p> <p>Injury to persons could result</p> <p>Install anti-tip devices packed with range</p> <p>See installation instructions</p>

# IMPORTANT SAFETY INSTRUCTIONS

**⚠ WARNING:** If the information in this manual is not followed exactly, a fire or explosion may result causing property damage, personal injury, or death.

- Do not use or store gasoline or other combustible liquids or vapors in the vicinity of this or any other appliance.
- WHAT TO DO IF YOU SMELL GAS
  - Do not try to light any appliance.
  - Do not touch any electric switches.
  - Do not use any phones inside your building.
  - Immediately call your gas supplier from a neighbor's phone. Follow the gas supplier's instructions.
  - If you are unable to reach your gas provider, call the fire department.
- Installation and service must be performed by a qualified installer, qualified service agency or your gas provider.  
(In Massachusetts, installation must be performed by a licensed installer / gas fitter.)
- Note to the installer:  
Please give these installation instructions to the consumer for the local electrical/gas inspector.



# Contents

---

<b>IMPORTANT SAFETY INSTRUCTIONS</b> .....	2
<b>IMPORTANT SAFETY INSTRUCTIONS</b> .....	8
<b>Guide to the range</b> .....	22
Gas cooktop HR 1934-3 DF .....	22
Oven HR 1934-3 DF .....	23
Gas cooktop HR 1935-3 DF .....	24
Oven HR 1935-3 DF .....	25
Gas cooktop HR 1936-3 DF .....	26
Oven HR 1936-3 DF .....	27
<b>Controls for the range</b> .....	28
Controls for gas cooktop HR 1934-3 DF .....	28
Controls for gas cooktops HR 1935-3 DF and HR 1936-3 DF .....	28
Oven controls .....	30
On/Off button .....	31
Proximity sensor (MotionReact) .....	31
Sensor buttons .....	32
Touch display .....	33
Symbols .....	34
<b>Using the appliance</b> .....	35
Selecting a menu option .....	35
Scrolling .....	35
Exiting a menu .....	35
Changing a value or setting .....	35
Changing a setting in a list .....	35
Entering numbers with the roller .....	35
Entering numbers using the numerical keypad .....	35
Changing the setting with a segment bar .....	35
Entering letters .....	36
Displaying the context menu .....	36
Moving entries .....	36
Displaying the pull-down menu .....	36
Displaying Help .....	36
Activating MobileStart .....	36
<b>Features</b> .....	37
Data plate .....	37
Extra data plate .....	37
Scope of delivery .....	37
Standard and optional accessories .....	37
Gas cooktop safety features .....	40
Oven safety features .....	41
PerfectClean treated surfaces .....	41
Self-Clean-ready accessories .....	41

<b>Before first use</b> .....	42
Miele@home .....	42
Basic settings .....	43
Cleaning the cooktop before heating it up for the first time.....	44
Seasoning the griddle plate.....	44
Heating up the oven for the first time and rinsing the steam injection system ...	45
<b>Using the gas cooktop</b> .....	46
Energy-saving tips.....	46
Suitable cookware.....	46
Switching on the burner .....	47
Switching on during a power failure.....	47
Adjusting the flame.....	47
Switching off the burner .....	48
Using the grill.....	48
Using the griddle plate .....	49
<b>Using the oven</b> .....	51
Energy-saving tips.....	51
Changing values and settings for a cooking program.....	53
Changing the temperature and core temperature .....	53
Setting additional durations .....	54
Changing set durations .....	54
Deleting the set cooking durations.....	54
Canceling a cooking program .....	54
Preheating the oven .....	55
Booster .....	55
Preheat .....	56
Crisp function .....	57
Changing the operating mode.....	57
<b>Settings</b> .....	58
Settings overview .....	58
Opening the “Settings” menu.....	61
Language  .....	61
Time.....	61
Date .....	62
Lighting.....	62
Start screen .....	62
Display .....	62
Volume.....	63
Units of Measurement .....	63
Booster .....	63
Recommended temperatures.....	63
Self clean.....	64
Cooling fan run-on .....	64

# Contents

---

Proximity sensor (MotionReact) .....	64
Safety .....	65
Miele@home .....	65
Remote Control .....	66
Activating MobileStart .....	66
SuperVision .....	66
RemoteUpdate .....	67
Lift-up panel .....	68
Electrical version .....	68
Probe .....	68
Calibrate temperature .....	68
Software version .....	69
Legal information .....	69
Showroom Program .....	69
Factory default .....	69
<b>Alarm + Timer</b> .....	70
Using the Alarm function .....	70
Using the Timer function .....	71
<b>Main and submenus</b> .....	72
<b>Moisture Plus</b> .....	74
Starting a cooking program with Moisture Plus .....	75
<b>Automatic Programs</b> .....	77
Categories .....	77
Using automatic programs .....	77
Usage notes .....	77
Search .....	78
<b>Special Modes</b> .....	79
Defrost .....	79
Dehydrate .....	80
Warm-up Cookware .....	81
Proof .....	81
Keep warm .....	81
Slow Roasting .....	82
Sabbath Program .....	85
Canning .....	86
Frozen food/ready meals .....	88
<b>MyMiele</b> .....	89
<b>Favorites</b> .....	90
<b>Baking</b> .....	93
Tips for baking .....	93
Notes on the operating modes .....	94

<b>Roasting</b> .....	95
Tips for roasting .....	95
Notes on the operating modes .....	96
Probe .....	97
<b>Broiling</b> .....	100
Tips for broiling.....	100
Notes on the operating modes.....	101
<b>Gas cooktop cleaning and care</b> .....	102
<b>Cleaning and care of the oven</b> .....	106
Unsuitable cleaning agents .....	106
Removing normal soiling .....	107
Removing stubborn soiling.....	107
Cleaning the oven compartment with Self clean.....	108
Removing the door.....	111
Installing the door.....	112
Side rack removal.....	113
<b>Frequently Asked Questions</b> .....	114
<b>Customer Service</b> .....	121
Contact in the event of a fault .....	121
Data plate .....	121
Appliance warranty and product registration .....	121
<b>Caring for the environment</b> .....	122
<b>Declaration of conformity</b> .....	123
<b>Copyrights and licenses</b> .....	124

# IMPORTANT SAFETY INSTRUCTIONS

---

**When using the appliance, follow basic safety precautions, including the following:**

**Read all instructions before installation and use of the range to prevent accidents and machine damage.**

This range complies with current safety requirements. However, improper use of the appliance can result in personal injury or damage to property.

Please read the installation instructions carefully before installing and connecting the appliance.

Read the operating instructions before using the range for the first time. To prevent accidents and damage to the appliance, always observe both the installation instructions and operating instructions. Both documents contain important information about installation, safety, use and maintenance.

Miele cannot be held liable for damage occurring as a result of non-compliance with the instructions.

Keep these installation instructions and operating instructions in a safe place and pass them on to any future owner.

## **Appropriate use**

- ▶ This range is intended for domestic use and use in other similar environments.
- ▶ This appliance is not intended for outdoor use.
- ▶ Use the range exclusively under normal domestic conditions:
  - Use the oven for baking, roasting, broiling, defrosting, canning and drying food.
  - Use the cooktop to prepare food and keep it warm.

Any other use is not permitted.

- ▶ Risk of Fire! Do not use this oven to store or dry combustible materials.



## IMPORTANT SAFETY INSTRUCTIONS

---

- ▶ Persons who lack physical, sensory or mental abilities, or experience with the appliance should not use it without supervision or instruction by a responsible person.
- ▶ The oven compartment is equipped with special bulbs to cope with particular conditions (e.g., temperature, moisture, chemical resistance, abrasion resistance, and vibration). These special bulbs must only be used for the purpose for which they are intended. They are not suitable for room lighting.

### **Safety with children**

- ▶ Children should be supervised in the vicinity of the range. Never allow children to play with the range.
- ▶ Children must be kept away from the range unless they are constantly supervised.
- ▶ Risk of burns due to improper use. Do not allow children to operate the range.
- ▶ Burn Hazard - Do not allow children to use the oven. Failure to do so can result in severe burns or serious injury.
- ▶ Burn Hazard - Do not allow children to use the cooktop. Failure to do so can result in severe burns or serious injury.
- ▶ Risk of suffocation from packaging material. While playing, children may become entangled in packaging material (such as plastic wrapping) or pull it over their head, presenting the risk of suffocation. Keep packaging material away from children.
- ▶ Risk of injury caused by hot surfaces. Children's skin is far more sensitive to high temperatures than that of adults. External parts of the oven such as the door glass, control panel, and the vent become quite hot. Do not let children touch the oven when it is in operation.
- ▶ Risk of injury caused by hot surfaces. Children's skin is far more sensitive to high temperatures than that of adults. The oven gets much hotter during the Self Clean program than during normal use. Do not let children touch the oven during the Self Clean program.

## IMPORTANT SAFETY INSTRUCTIONS

---

▶ The cooktop gets hot when in use and remains hot for some time after being turned off. Keep children away from the appliance until it has cooled down and is no longer a burn hazard.

▶ Burn hazard!

Keep the spaces above and behind the cooktop clear of any items that could draw the attention of children. Otherwise, they can be tempted into climbing onto the appliance.

▶ Risk of injury from the open door. The oven door can support a maximum weight of 33 lbs (15 kg). Children could injure themselves on an open door.

Do not let children sit on the door, lean against it, or swing on it.

▶ Risk of burning or scalding.

Turn pot and pan handles inward, so children cannot pull them down and be burned.

### Technical safety

▶ This appliance must be installed and connected in compliance with the installation instructions.

▶ Unauthorized installation, maintenance, and repairs can cause considerable danger for the user. Installation, maintenance, and repairs should only be carried out by a Miele authorized technician.

▶ Do not carry or lift the range by the oven door handle or the control panel!

▶ Changes or modifications not expressly approved by Miele may void the user's authority to operate the oven.

▶ Maintenance by the user: Never repair or replace any part of the appliance unless the instructions specifically recommend doing so. Service work should only be performed by a qualified technician.

▶ A damaged range can be dangerous. Always check for visible signs of damage. Never use a damaged appliance.

## IMPORTANT SAFETY INSTRUCTIONS

---

▶ Temporary or permanent operation on an autonomous power supply system or a power supply system that is not synchronized with the grid power supply (e.g., island networks, back-up systems) is possible. A prerequisite for operation is that the power supply system complies with national and local codes.

The function and operation of the protective measures provided in the domestic electrical installation and in this Miele product must also be maintained in isolated operation or in operation that is not synchronized with the grid power supply, or these measures must be replaced by equivalent measures in the installation.

▶ The electrical safety of the range can only be guaranteed when it is properly grounded. Compliance with this essential safety requirement is absolutely mandatory. If in any doubt, please have the building's wiring system inspected by a qualified electrician.

▶ Proper installation: Make sure that your appliance has been installed correctly and that it has been grounded by a qualified technician.

▶ To avoid damaging the range, make sure that the connection data (voltage and frequency) on the data plate correspond to the building's power supply before connecting the appliance. When in doubt, consult a qualified electrician.

▶ Installation and maintenance of the gas connection must be performed by qualified installers, service agencies or gas providers.

▶ During installation, maintenance and repair work, e.g. if the oven lighting is broken, the range must be completely disconnected from the power supply (see "Frequently asked questions"). The gas inlet valve must be closed. It is only completely isolated from the supply when:

- The circuit breakers have been switched off, or
- the fuses of the electrical installation have been completely removed, or
- the plug (if present) is removed from the outlet. To do this, pull the plug not the cord.
- Shut off the gas supply and disconnect the range from the gas supply. Installation and maintenance of the gas connection must be performed by qualified installers, service agencies or gas providers.

## IMPORTANT SAFETY INSTRUCTIONS

---

- ▶ Do not use a power strip or extension cord to connect the range to electricity. These are a fire hazard and do not guarantee the required level of appliance safety.
- ▶ For safety reasons, only use the range when it has been fully installed.
- ▶ This range must not be installed and operated in non-stationary installations (e.g., on a ship).
- ▶ Risk of injury due to electric shock. Any contact with live connections or tampering with the electrical or mechanical components of the range will endanger your safety and may lead to appliance malfunctions.  
Do not open the range housing under any circumstances.
- ▶ Any repairs not performed by a Miele authorized service technician will void the warranty.
- ▶ Miele can only guarantee the safety of the appliance when original Miele parts are used. Faulty components must only be replaced with genuine Miele parts.
- ▶ If the power cord is damaged, it must be replaced with a special power cord by a Miele authorized technician (see “Installation – Electrical connection”).
- ▶ Danger of electric shock.  
If the cooktop is defective, immediately turn the appliance off and discontinue use. Disconnect it from the electricity and gas supply. Contact Customer Service.
- ▶ The range requires a sufficient supply of cool air for efficient operation. Make sure that the supply of cool air is not hindered in any way (e.g., by installing heat insulation strips in the cabinet niche). In addition, the required supply of cool air must not be excessively heated by other heat sources.
- ▶ Reaching over a hot cooktop to access the cabinets can result in burns. You can reduce the risk of burns by installing a range hood that extends at least 4 3/4" (12 cm) past the bottom of the cabinets.

## IMPORTANT SAFETY INSTRUCTIONS

---

- ▶ The water shut-off valves must be accessible when the appliance is installed.
- ▶ The protective sleeve of the water intake hose must not be damaged or become kinked.
- ▶ The integrated water protection system offers protection from water damage, provided the following conditions are met:
  - The appliance is properly installed (electric and water).
  - A damaged appliance is dangerous. Contact Miele to have it repaired immediately.
  - Turn off the water supply when the appliance is not in use for an extended period (e.g., vacation).
- ▶ The water quality must conform to the requirements for drinking water in the country in which the oven is being used.

### **Correct use**

- ▶ **Caution:** Heating elements may be hot even though they are not glowing. Interior surfaces of an oven become hot enough to cause burns. External parts of the oven such as the door glass, vents, and the control panel can become hot. During and after use, do not touch, or let clothing or other flammable materials come into contact with heating elements or interior surfaces of the oven until they have had sufficient time to cool.
- ▶ Do not let food sit in the oven for an extended period of time before or after cooking. Doing so can result in food poisoning or sickness.
- ▶ Loose fitting or hanging garments present a fire hazard. Wear proper apparel while operating the appliance.
- ▶ Use only dry, heat-resistant potholders. Moist or damp potholders used on hot surfaces may result in steam burns. Do not let potholders come in contact with oil or grease. Do not substitute dish towels or other bulky items for potholders. Do not let potholders touch hot heating elements.
- ▶ Open the door carefully to allow hot air or steam to escape before placing or removing food.

## IMPORTANT SAFETY INSTRUCTIONS

---

- ▶ To prevent burns, always place oven racks at their desired height while the oven is cool. If the rack must be moved while the oven is hot, do not let pot holders touch hot heating elements.
- ▶ To prevent burns, allow the heating elements to cool before cleaning by hand.
- ▶ Smother the fire or flames, or use a dry chemical extinguishing agent or foam fire extinguisher.
- ▶ Never store flammable liquids and materials in, above or under an oven, or near cooking surfaces.

### WARNING

NEVER use this appliance as a space heater to heat or warm the room. Doing so may result in carbon monoxide poisoning and overheating of the oven.

### WARNING

NEVER use this appliance as storage space. Doing so may result in carbon monoxide poisoning and overheating of the oven.



### WARNING

NEVER cover any slots, holes or openings in the oven bottom or cover an entire rack with materials such as aluminum foil. Doing so blocks air flow through the oven and may cause carbon monoxide poisoning. Aluminum foil linings may also trap heat, causing a fire hazard.

- ▶ Do not obstruct the flow of combustion and ventilation air.
- ▶ This oven must only be used for cooking food. Corrosive chemicals and vapors as well as fumes, vapors or heat given off by glues, plastics or flammable liquids and materials could be hazardous. Do not use it as a dryer, kiln, dehumidifier, etc.
- ▶ Do not let metal objects (aluminum foil, pans) come in contact with the heating element.
- ▶ Make certain that the power cords of small appliances do not come in contact with or get caught in the oven door.

## IMPORTANT SAFETY INSTRUCTIONS

---

- ▶ When baking frozen pizzas or pies, place them on the wire rack lined with parchment paper. Do not use the baking tray or the roasting pan for frozen foods with a large surface area. The tray or pan could become warped and difficult to remove from the oven when hot. Frozen foods like french fries, chicken nuggets, etc. can be baked on the baking tray.
- ▶ Risk of injury caused by hot surfaces. The oven gets hot during operation. You could burn yourself on the heating elements, oven compartment, accessories, or food. When the oven is hot, use pot holders to insert, remove, or turn food, as well as when adjusting the oven shelves, etc.
- ▶ The high temperatures radiated could cause objects near the oven to catch fire. Do not use the oven to heat the room.
- ▶ Oils and fats are a fire hazard if allowed to overheat. Never leave the oven unattended when cooking with oil or fats. Never attempt to put out oil or fat fires with water. Turn the oven off and extinguish the flames by leaving the door closed.
- ▶ Do not use water on cooktop grease fires. Turn the cooktop off. Smother or use a dry chemical or foam-type extinguisher on any fire or flame.
- ▶ Broiling food for excessively long cooking durations can cause it to dry out with the risk of catching fire. Do not exceed the recommended cooking durations.
- ▶ Some foods dry out very quickly and can be ignited by high broiling temperatures. Do not use broiling modes for crisping rolls or bread, or to dry flowers or herbs. Instead use the Convection Bake/Convection Roast  or Surround  modes.
- ▶ If using alcohol in your recipes, please be aware that high temperatures can cause the alcohol to evaporate. The vapor can catch fire on hot heating elements.

## IMPORTANT SAFETY INSTRUCTIONS

---

▶ Plastic or aluminum foil cookware melts at high temperatures and can damage the range or start to burn. Do not use any plastic or aluminum foil cookware.

Exception: You can use oven-safe plastic cookware in the oven. Heed the cookware manufacturer's instructions.

▶ When using residual heat to keep food warm, corrosion from high air humidity and condensation can occur in the oven. This can cause damage to the control panel, countertop, and cabinet carcass. Keep the oven on and select the lowest temperature available for the selected operating mode. The cooling fan will then continue to run automatically.

▶ Food which is stored in the oven compartment or left in it to be kept warm can dry out and the moisture released can lead to corrosion damage in the oven. Always cover food that is left in the oven to keep warm.

▶ A buildup of heat can cause the enamel on the floor of the oven to crack or flake off.

Never line the floor of the oven with aluminum foil or oven liners.

If you wish to place dishware on the floor of the oven during the cooking process, or place dishware on the floor of the oven to heat it up, you can do so, but only with the Convection Bake/Convection Roast  operating mode, without the Booster function.

▶ The oven floor can become damaged by items being pushed around on it. When placing pots, pans, or dishware on the oven floor, do not push them around.

▶ Risk of injury caused by steam. Pouring a cold liquid onto a hot surface creates steam, which can cause severe scalding. The sudden temperature change can also cause damage to hot surfaces. Never pour cold liquids directly onto hot enameled surfaces.

▶ Risk of injury caused by steam. During cooking processes with moisture injection and during the residual moisture evaporation process, steam is produced, which can lead to severe scalding. Never open the door when bursts of steam are being injected.

▶ It is important that the temperature in the food being cooked is evenly distributed and sufficiently high. You can ensure this by stirring or turning the food.



## IMPORTANT SAFETY INSTRUCTIONS

---

- ▶ Canning food and heating it up in closed containers results in an increase in pressure which can cause them to explode. Do not use cans for canning or reheating food.
- ▶ Risk of injury from the open door. You could bang into the open door or trip over it. Do not leave the door open unnecessarily.
- ▶ The door can support a maximum load of 33 lbs (15 kg). Do not lean or sit on an open door, or place heavy items on it. Make sure that nothing gets trapped between the door and the oven compartment. This could damage the oven.
- ▶ The flames could set the grease filters of a ventilation hood on fire. Do not flambé under a ventilation hood.
- ▶ Never heat empty cookware.
- ▶ If the cooktop is covered, there is a risk that the material of the cover will ignite, explode or melt if the cooktop is still hot or if turned on inadvertently. Never cover the cooktop with a board, cloth or protective sheet.
- ▶ When using an electric appliance, e.g. a hand mixer, near the cooktop, make sure that the power cable does not come into contact with the hot cooktop. The cable's insulation could become damaged.
- ▶ The cooktop gets hot when in use and remains hot for some time after being turned off. Do not touch the appliance if there is a possibility that it could still be hot.
- ▶ When the appliance is turned on inadvertently or by mistake, or when there is residual heat present, there is a risk of the metal items heating up. Other materials can melt or catch fire when the appliance is switched on. Do not store items on the cooktop.
- ▶ Metallic objects such as knives, forks, spoons and lids should not be placed on the cooktop surface since they can get hot.
- ▶ Wet sponges or clothes can cause burns due to hot steam if they are used to wipe spilled food off a hot burner. Some cleansers can emit hazardous vapors if they are applied to a hot surface. Be careful when cleaning the cooktop.

## IMPORTANT SAFETY INSTRUCTIONS

---

- ▶ Spilled food can cause odors and the spraying of grease, which can ignite on the cooktop. Never leave the cooktop unsupervised at high power.
- ▶ If the handles of a pot or pan extend across an adjacent burner, this can cause burns, the ignition of flammable materials and the spilling of food due to inadvertent contact with the cookware. Turn the pot or pan so that the handles point toward the inside and do not extend across an adjacent burner.
- ▶ Ensure that the igniters are clean and dry to allow the burners to ignite and burn properly.
- ▶ A range hood installed above the cooktop can become damaged or catch fire as a result of intense heat. Do not use the gas burners without cookware.
- ▶ Only light the gas burners after all burner parts have been properly assembled.
- ▶ If the cookware is too small, it will not sit properly on the burner grate. If the cookware is too large, heat emitted from the bottom of the cookware may damage the countertop, walls with poor heat-resistance (e.g. paneled walls) or portions of the cooktop.
- ▶ Make sure that the burner flames do not extend beyond the bottom of the cookware and rise up its sides.
- ▶ Only use cookware with a thick enough bottom. Failure to do so may result in damage to the cooktop.
- ▶ Always use the burner grates supplied with the cooktop. Never place cookware directly on the burner.
- ▶ Install the burner grates in an upright position to avoid scratching the cooktop.
- ▶ Remove all grease splatters and other flammable (food) residues on the cooktop. They are a fire hazard.

## IMPORTANT SAFETY INSTRUCTIONS

---

- ▶ Using of a gas cooktop causes heat, moisture and products of combustion to build up in the room in which it is installed. Make sure that your kitchen is well ventilated, especially when the appliance is in use: keep any natural means of ventilation open or install a mechanical ventilation system (e.g. a ventilation hood).
- ▶ If the cooktop is used for very long periods of time, additional ventilation of the room may be necessary, e.g. by opening windows or doors, or running the ventilation on the highest setting.
- ▶ Do not use pots or pans that are large enough to cover several burners. The resulting heat buildup can damage the appliance.
- ▶ If the cooktop has not been used for a long period of time, be sure to thoroughly clean it and have it inspected by an authorized technician before using it again.
- ▶ When you have finished cooking, make sure that the burners and oven are turned off by checking the position of the knobs.
- ▶ Only certain types of glass, ceramic or other enamel cookware can be used on a gas cooktop without breaking as a result of sudden temperature changes.
- ▶ Do not use cooking utensils on the grill.
- ▶ Ask your installer to show you the location of your gas shutoff valve and fuses or circuit breaker panel in your apartment or home. Be sure that you know how and where to disconnect the gas and power supply to your cooktop.
- ▶ The grates, burner cap, bottom parts of the burner, and any other parts located near the burner flame, can still be very hot after cooking and cause burns. Do not touch these components when using the cooktop.
- ▶ Wind can blow curtains over the cooktop, causing them to catch fire. If the cooktop is installed near a window, do not use long curtains.
- ▶ Not any cookware of glass, glass ceramic, ceramic, clay or other glass cookware is suitable for use on a burner. It can be damaged due to sudden temperature change.

## IMPORTANT SAFETY INSTRUCTIONS

---

- ▶ The wireless roast probe antenna on the top right of the oven interior is at risk of damage when sliding in accessories. When sliding in accessories, take care not to bang them against the wireless roast probe.
- ▶ The wireless roast probe antenna on the top right of the oven interior is at risk of damage when sliding the FlexiClips with wire rack in at level 6. Only use the FlexiClips with wire rack at levels 1 to 5.

### **The following applies to stainless steel surfaces:**

- ▶ Adhesives will damage the coated stainless steel surface and cause it to lose its dirt-repellent protective coating. Do not use sticky notes, adhesive tape, or other types of adhesive on the stainless steel surface.
- ▶ Magnets can cause scratches. Do not use the stainless steel surface as a magnetic notice board.

### **Cleaning and care**

- ▶ Only clean parts listed in these operating and installation instructions.
- ▶ There is a delicate fiberglass seal around front of the oven compartment provide a seal for the glass on the inside of the oven door. This can be damaged by rubbing or scouring. If possible, refrain from cleaning this.
- ▶ Do not use oven cleaners. Do not use standard oven cleaners in the oven compartment or on the front of the oven. Never line the oven with oven liners.
- ▶ Risk of injury due to electric shock. The steam from a steam cleaning appliance could reach live electrical components and cause a short circuit. Never use a steam cleaner for cleaning.
- ▶ Scratches on the door glass can cause the glass to break. Do not use abrasive cleaners, hard sponges, brushes, or sharp metal tools to clean the door glass.

## IMPORTANT SAFETY INSTRUCTIONS

---

- ▶ The side runners can be removed (see “Cleaning and care of the oven – Removing the side runners”). Reinstall the side runners correctly.
- ▶ Coarse soiling in the oven compartment can cause thick smoke to develop. Remove coarse soiling from the oven compartment before running the Self Clean program.
- ▶ In warm, moist environments, there is a higher probability of pest infestations. Ensure the oven and the area surrounding it are always kept clean.  
Damage caused by pests is not covered by the warranty.

### Accessories

- ▶ Only use original Miele accessories. Using parts or accessories from other manufacturers will invalidate the warranty, and Miele cannot accept liability.
- ▶ Only use the Miele probe supplied with the appliance. If it is faulty, it must be replaced with a new original Miele probe.
- ▶ The plastic on the probe can melt at very high temperatures. Do not use the probe when using the broiling operating modes. Do not store the probe in the oven compartment when it is not being used.
- ▶ Accessories that are not suitable for the Self Clean program will be damaged by the high temperatures. Remove all accessories that are not suitable for the Self Clean program from the oven compartment before starting the Self Clean process. This also applies to optional accessories that are not suitable for the Self Clean program (see “Cleaning and care of the oven”).

### Preparing for a long period of absence

- ▶ If you turn off your domestic water connection when you're going to be away for a long period of time, please note that this may not be enough to prevent water damage. To eliminate the risk of water damage, close the faucet at each individual appliance.

**KEEP THE OPERATING AND INSTALLATION INSTRUCTIONS IN A SAFE PLACE AND REVIEW THEM PERIODICALLY.**

# Guide to the range

## Gas cooktop HR 1934-3 DF

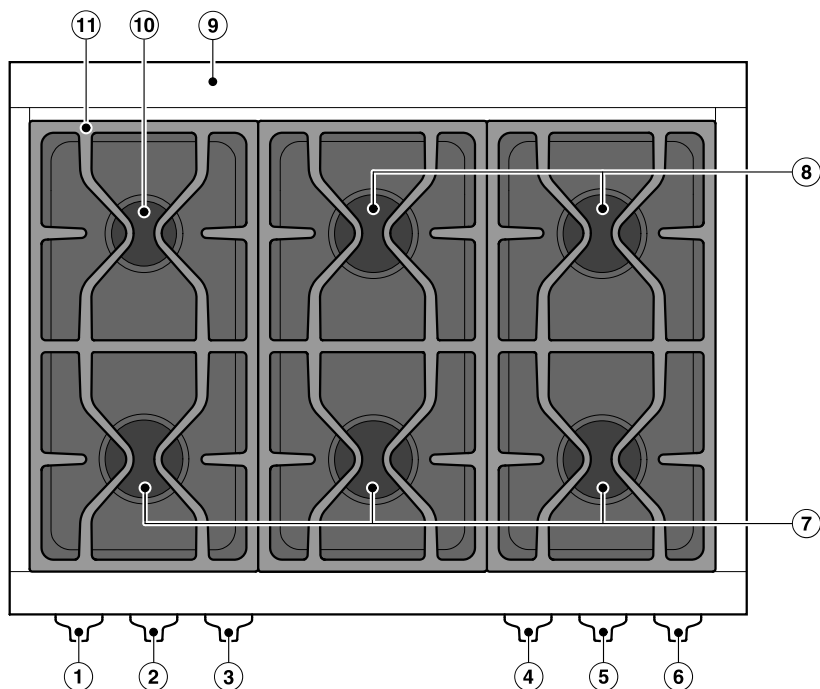

- ① Control knob  
Rear left burner
- ② Control knob  
Front left burner
- ③ Control knob  
Front middle burner
- ④ Control knob  
Rear middle burner
- ⑤ Control knob  
Front right burner
- ⑥ Control knob  
Rear right burner
- ⑦ Extra large burner, front
- ⑧ Extra large burner, rear
- ⑨ Island trim
- ⑩ Power burner
- ⑪ Grates

## Oven HR 1934-3 DF

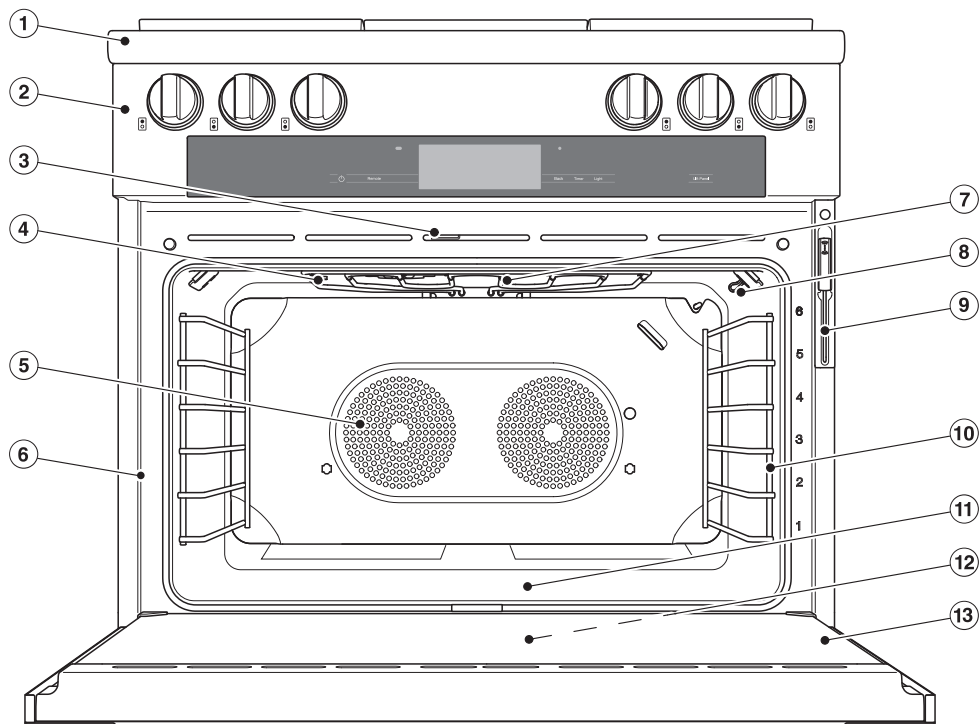

- ① Gas cooktop
- ② Controls
- ③ Door lock
- ④ Steam inlet openings
- ⑤ Air inlets for the blowers with ring heating elements behind them
- ⑥ Extra data plate  
For connecting the oven to your WiFi
- ⑦ Browning/Broiling element
- ⑧ Wireless precision probe antenna
- ⑨ Wireless precision probe
- ⑩ Side runners with 6 shelf levels
- ⑪ Oven floor with bottom heat element underneath it
- ⑫ Data plate  
The data plate is located behind the toe-kick panel
- ⑬ Door

# Guide to the range

## Gas cooktop HR 1935-3 DF

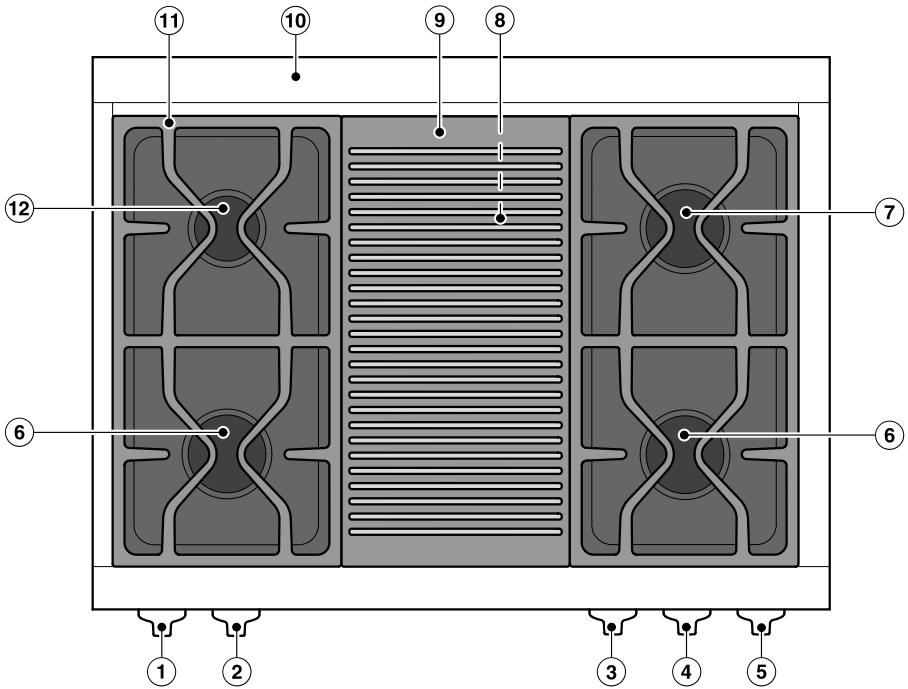

- ① Control knob  
Rear left burner
- ② Control knob  
Front left burner
- ③ Control knob for grill
- ④ Control knob  
Front right burner
- ⑤ Control knob  
Rear right burner
- ⑥ Extra large burner, front
- ⑦ Extra large burner, rear
- ⑧ Thermostatically controlled ceramic burner
- ⑨ Grill
- ⑩ Island trim
- ⑪ Grates
- ⑫ Power burner



## Oven HR 1935-3 DF

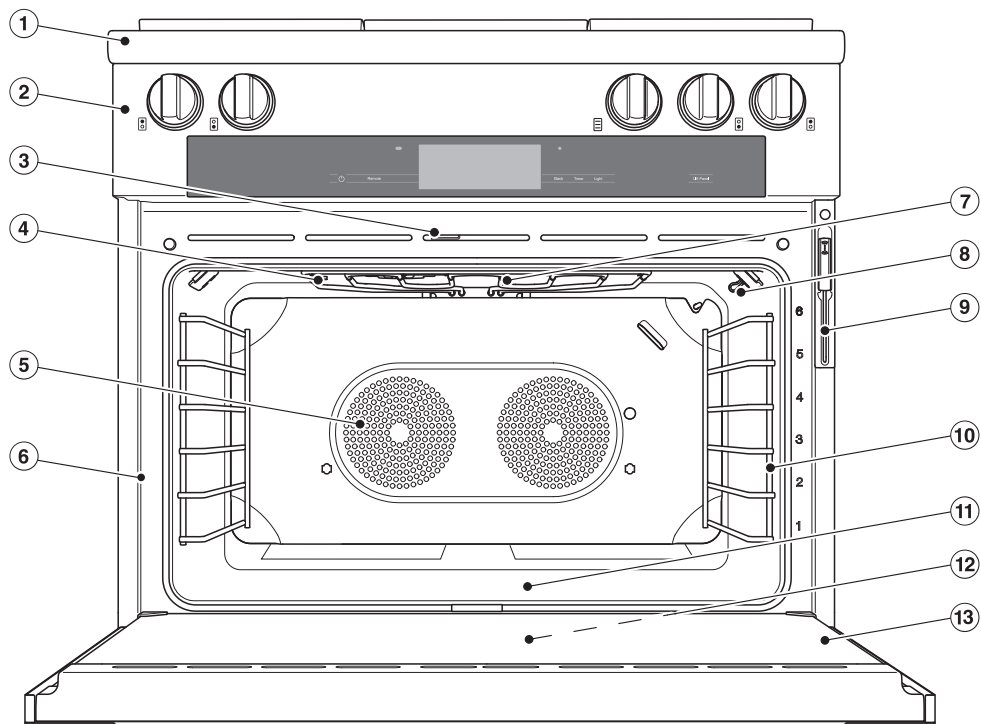

- ① Gas cooktop
- ② Controls
- ③ Door lock
- ④ Steam inlet openings
- ⑤ Air inlets for the blowers with ring heating elements behind them
- ⑥ Extra data plate  
For connecting the oven to your WiFi
- ⑦ Browning/Broiling element
- ⑧ Wireless precision probe antenna
- ⑨ Wireless precision probe
- ⑩ Side runners with 6 shelf levels
- ⑪ Oven floor with bottom heat element underneath it
- ⑫ Data plate  
The data plate is located behind the toe-kick panel
- ⑬ Door

# Guide to the range

## Gas cooktop HR 1936-3 DF

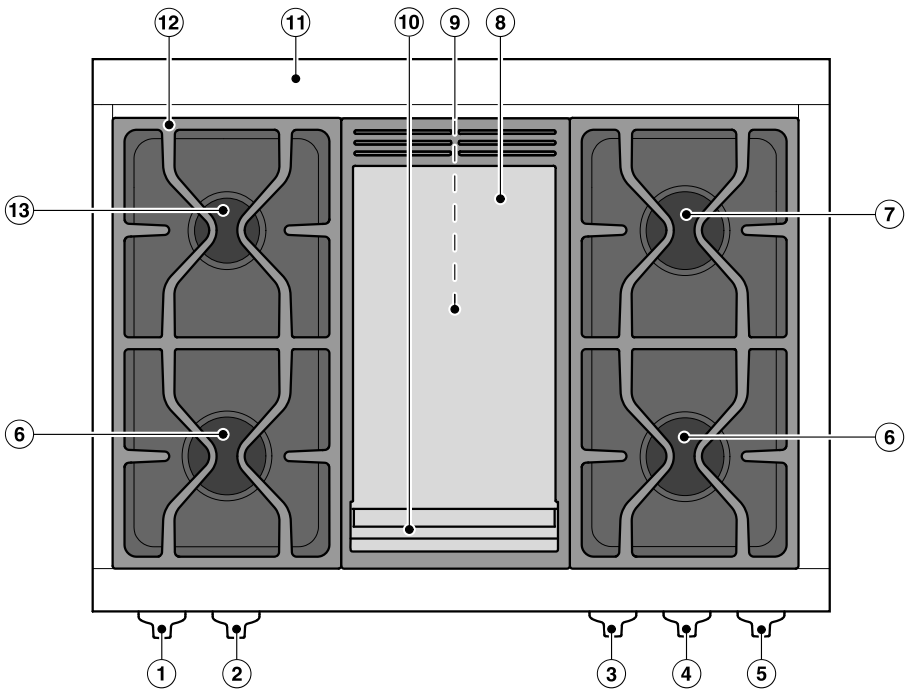

- ① Control knob  
Rear left burner
- ② Control knob  
Front left burner
- ③ Control knob for griddle plate
- ④ Control knob  
Front right burner
- ⑤ Control knob  
Rear right burner
- ⑥ Extra large burner, front
- ⑦ Extra large burner, rear
- ⑧ Griddle plate
- ⑨ Thermostatically controlled ceramic  
burner
- ⑩ Grease drip tray
- ⑪ Island trim
- ⑫ Grates
- ⑬ Power burner

## Oven HR 1936-3 DF

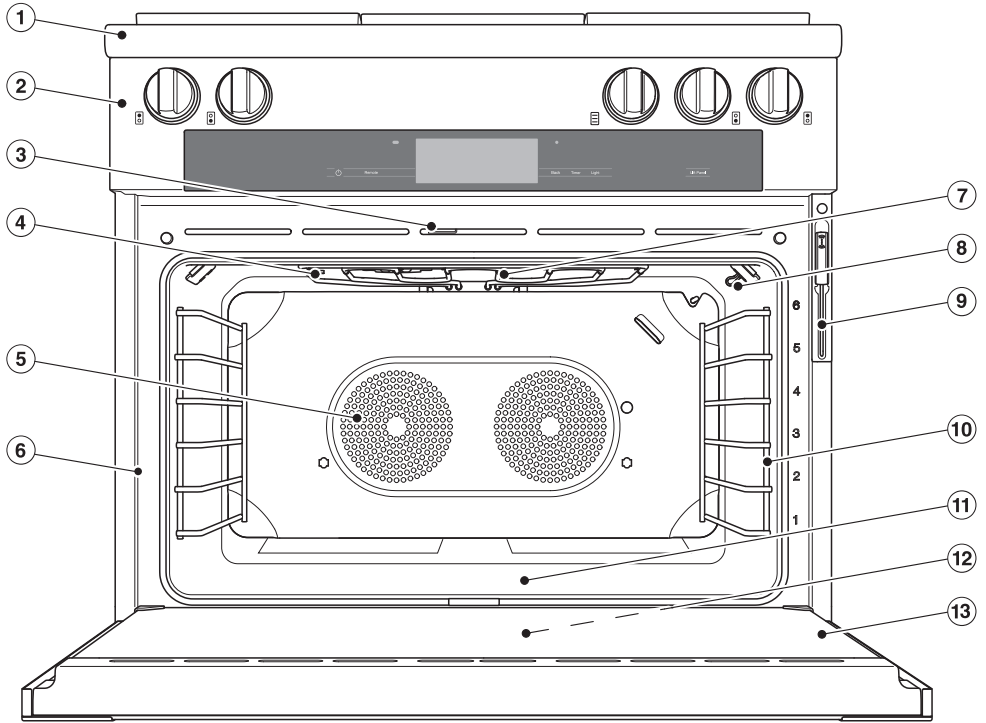

- ① Gas cooktop
- ② Controls
- ③ Door lock
- ④ Steam inlet openings
- ⑤ Air inlets for the blowers with ring heating elements behind them
- ⑥ Extra data plate  
For connecting the oven to your WiFi
- ⑦ Browning/Broiling element
- ⑧ Wireless precision probe antenna
- ⑨ Wireless precision probe
- ⑩ Side runners with 6 shelf levels
- ⑪ Oven floor with bottom heat element underneath it
- ⑫ Data plate  
The data plate is located behind the toe-kick panel
- ⑬ Door

# Controls for the range

---

## Controls for gas cooktop HR 1934-3 DF

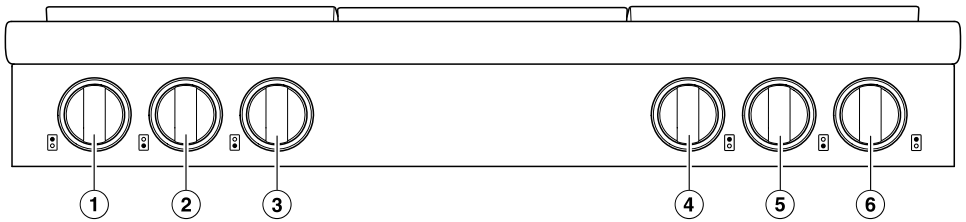

- ① Control knob  
Rear left burner
- ② Control knob  
Front left burner
- ③ Control knob  
Front middle burner
- ④ Control knob  
Rear middle burner
- ⑤ Control knob  
Front right burner
- ⑥ Control knob  
Rear right burner

## Controls for gas cooktops HR 1935-3 DF and HR 1936-3 DF

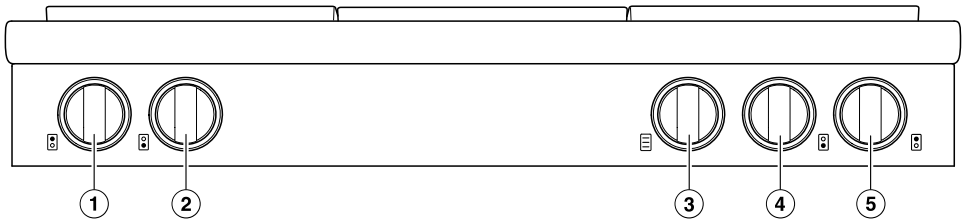

- ① Control knob  
Rear left burner
- ② Control knob  
Front left burner
- ③ Control knob  
HR 1935-3 DF: grill  
HR 1936-3 DF: griddle plate
- ④ Control knob  
Front right burner
- ⑤ Control knob  
Rear right burner

## Controls for the range

The knobs are illuminated with a light ring.

The control knob for each burner is used to ignite the burner and regulate the strength of the flame. The burners can be variably adjusted between the lowest and highest flame settings.

### Control knobs for normal and power burners

Label	Description
<i>Off</i>	Gas supply off: burner off
<i>High</i>	Strongest flame setting: Maximum power of upper and lower flame rings
<i>Simmer</i>	Weakest flame setting: Upper flame ring off Minimum power of lower flame ring

### Control knob for grill

The range HR 1935-3 DF has a grill. The grill is heated by means of a thermostatically controlled ceramic burner.

Label	Description
<i>Off</i>	Gas supply off: grill off
<i>High</i>	Highest power level
<i>Low</i>	Lowest power level

### Control knob for griddle plate

The range HR 1936-3 DF has a griddle plate. The griddle plate is heated by means of a thermostatically controlled ceramic burner.

Label	Description
<i>Off</i>	Gas supply off: griddle plate off
<i>Low</i>	Lowest power level
•*	Medium power level
<i>High</i>	Highest power level

\* The symbol without a label indicates a medium power level.

# Controls for the range

## Oven controls

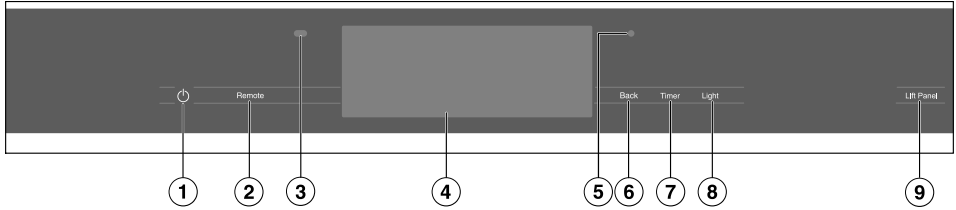

- ① Recessed  On/Off button  
For turning the oven on and off
- ② *Remote* sensor button  
For controlling the oven via your mobile device
- ③ Proximity sensor (MotionReact)  
For turning on the oven interior lighting and the display when approached, and to dismiss the audible signal when movement is detected
- ④ Touch display  
For displaying information and for operation
- ⑤ Optical interface  
(for Miele Service only)
- ⑥ *Back* sensor button  
To go back a step
- ⑦ *Timer* sensor button  
To activate or deactivate timers or alarms
- ⑧ *Light* sensor button  
For switching the oven interior lighting on and off
- ⑨ *Lift Panel* sensor button  
For raising and lowering the control panel

### **On/Off button**

The  On/Off button is recessed and reacts to touch.

Use this button to turn the oven on and off.

### **Proximity sensor (MotionReact)**

The proximity sensor is located under the touch display next to the *Back* sensor button. The proximity sensor detects when you approach the touch display, e.g., with your hand or body.

If you have activated the corresponding settings, you can turn on the oven interior lighting, turn on the oven, or acknowledge the audible signals (see “Settings – Proximity sensor (MotionReact)”).

# Controls for the range

---

## Sensor buttons

The sensor buttons react to touch. Every tap of a sensor button is confirmed with an audible keypad tone. You can turn this keypad tone off by selecting the [Volume | Keypad Tone | Off](#) setting.

If you want the sensor buttons to respond even when the oven is turned off, select the [Display | QuickTouch | On](#) setting.

Sensor button	Function
<i>Remote</i>	<p>If you want to control the oven from your mobile device, you must have the Miele@home system, turn on the <a href="#">Remote Control</a> setting, and tap this sensor button. The sensor button then lights up and the MobileStart function is available.</p> <p>As long as this sensor button is illuminated, you can control the oven via your mobile device (see “Settings – Miele@home”).</p>
<i>Back</i>	<p>Depending on which menu you are in, this will take you back a level or back to the main menu.</p>
<i>Timer</i>	<p>If a menu appears on the display or if a cooking process is in progress, you can use this sensor button to set a timer (e.g., when boiling eggs) or an alarm (a specific time) at any point (see “Alarm + timer”).</p>
<i>Light</i>	<p>Select this sensor button to turn the oven interior lighting on and off.</p> <p>Depending on the setting selected, the oven interior lighting turns off after 15 seconds or remains constantly turned on or off.</p>
<i>Lift Panel</i>	<p>You can lift up and put down the control panel for the range automatically or manually (see “Settings – Lift-up panel”).</p> <p>The control panel closes automatically as soon as a Self Clean program is started.</p>



## Touch display

The sensitive surface of the touch display can be scratched by pointed or sharp objects, e.g., pens.

Only touch the display with your fingers.

Make sure that water cannot get behind the touch display.

The touch display is split into multiple areas.

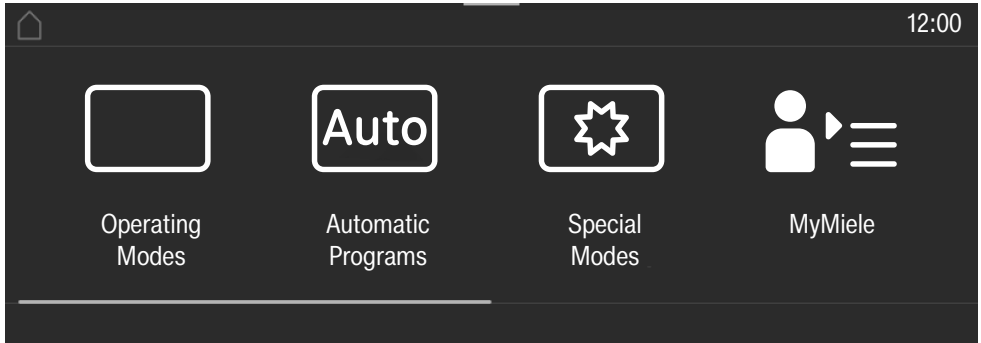

The menu path appears on the left of the **header**. The individual menu options are separated by a vertical line. ... I indicates that there are more menu options available if the menu path can no longer be displayed because there is not enough space on the display.

If you tap a menu name in the header, the display will switch to that menu. To switch to the start screen, tap .

The time of day is shown on the right of the header. You can set the time of day by tapping the display.

Additional symbols may also appear, e.g., SuperVision .

At the top of the header, there is an orange line where you can drag down the pull-down menu. This allows you to turn settings on or off during a cooking process.

The current menu and menu options are shown in the **center** of the display. You can scroll to the right or left by swiping your finger across the display to the right or left. Tap a menu option to select it (see “Using the appliance”).









The operation fields that appear in the **footer** vary according to the menu that is selected; e.g., Timer, Save or OK.

# Controls for the range

---

## Symbols

The following symbols may appear on the display:

Symbol	Meaning
	This symbol indicates that there is additional information and advice about using the appliance. Select <i>OK</i> to confirm the information.
	This indicates that there are more menu options available, which are not visible because there is not enough space on the display.
	Alarm
	Timer
	Some settings, e.g., display brightness and signal tone volume, are selected using a segment bar.
	The system lock or sensor lock is on (see “Settings – Safety”). The controls are locked.
	Core temperature when using the probe
	Remote control (only appears if you are in the Miele@home system and have selected the Remote Control   On setting)
	SuperVision (only appears if you are in the Miele@home system and have selected the SuperVision   SuperVision display   On setting)

You operate the oven via the touch display by tapping the menu option you want.

Each time you tap a possible option, the relevant characters (word and/or symbol) will light up **orange**.

Fields for confirming an operating step are highlighted in **green** (e.g., *OK*).

## Selecting a menu option

- Tap the field or value you want on the display.

## Scrolling

You can scroll left or right.

- Swipe across the screen. To do this, place your finger on the touch display and swipe it in the desired direction.

The bar at the bottom shows you where you are in the current menu.

## Exiting a menu

- Tap the *Back* sensor button or tap the ... I symbol in the menu path.
- Tap the  symbol to switch to the start screen.

Entries made before this which have not been confirmed with *OK* will not be saved.

## Changing a value or setting

### Changing a setting in a list

The current setting is highlighted in orange.

- Tap the desired setting.

The setting is now saved. This will take you back to the previous menu.

### Entering numbers with the roller

- Swipe the roller up or down until the desired value is displayed in the center.
- Confirm with *OK*.

The changed number is now saved.

### Entering numbers using the numerical keypad

- Tap on the value that is in the middle of the numerical keypad.

The numerical keypad appears.

- Tap the required numbers.

As soon as you enter a valid value, *OK* will turn green.

Use the arrow to delete the last entered number.

- Confirm with *OK*.

The changed number is now saved.

### Changing the setting with a segment bar

Some settings are represented by a  bar made up of segments. If all of the segments are illuminated, the maximum value is selected.

If none of the segments are illuminated or if only one is, the minimum value is selected or the setting is turned off altogether (e.g., audible signals).

- Tap the corresponding segment on the segment bar to change the setting.
- Select *On* or *Off* to turn the setting on or off.
- Confirm your selection with *OK*.

The setting is now saved. This will take you back to the previous menu.

# Using the appliance

---

## Entering letters

Letters are entered using a display keyboard. It is best to select short names.

- Tap the letters or characters you want.

**Tip:** You can add a line break for longer program names using the  $\lrcorner$  symbol.

- Tap **Save**.

The name is now saved.

## Displaying the context menu

In some menus you can display a context menu, e.g., to rename Favorites or to move entries under *MyMiele*.

- For example, tap a Favorite and keep your finger on it until the context menu opens.
- To close the context menu, tap an area of the display located outside of the menu window.

## Moving entries

You can change the order of Favorites or entries under *MyMiele*.

- For example, tap a Favorite and keep your finger on it until the context menu opens.
- Select **Move**.
- Keep your finger on the highlighted field and drag it to the location you want.

## Displaying the pull-down menu

During a cooking program, you can turn settings such as **Booster** or **Preheat** and the  $\text{WiFi}$  function on or off.

- Use the orange line under the header to drag the pull-down menu down.
- Select the setting you want to change.  
Active settings are highlighted in orange. Depending on the selected color scheme, inactive settings are highlighted either in black or white (see “Settings – Display”).
- To close the pull-down menu, drag it back up to the top or tap an area of the display located outside of the menu window.

## Displaying Help

Context-sensitive help is available for certain functions. In this case, **Help** appears in the bottom line.

- Tap **Help** to display information in text and pictures.
- Tap **Close** to return to the previous menu.

## Activating MobileStart

- Select the *Remote* sensor button to activate MobileStart.

The *Remote* sensor button lights up. You can operate your oven remotely with the Miele app.

Directly operating on the oven takes priority over operating it via the remote control function on the app.  
You can use MobileStart as long as the *Remote* sensor button is lit up.

The models described in these operating instructions can be found at the end.

## Data plate

The data plate is located behind the toe kick panel. The toe kick panel is attached to the toe kick of the Range by magnets so it can be removed and put back again easily.

There you can find the model number, serial number and the connection data (voltage/frequency/maximum rated load) for your Range.

Have this information available if you need to contact Miele so that any issues can be rectified as quickly as possible.

## Extra data plate

The extra data plate for connecting the oven to your WiFi is located on the front frame of the oven.

## Scope of delivery

- Installation instructions for the range
- Operating instructions for the range, for using the cooktop and oven functions
- Precision probe
- Anti-tip device including screws for securing the range
- Various accessories

## Standard and optional accessories

Features will vary depending on model.

The side runners, universal tray, and wire rack (or “rack” for short) are supplied as standard with the oven.

Depending on the model, your oven may also come supplied with some of the accessories listed here.

All the accessories listed as well as the cleaning and care products are designed for Miele Ranges.

These can be ordered from the Miele web store, Miele Customer Service, or from your Miele dealer.

When ordering, please quote the model number of your range and the reference number of the accessories required.

## Side racks

Side racks for accessories are installed on either side of the oven compartment for shelf levels .

The shelf level numbers are indicated on the front of the oven frame.

Each level consists of a rail on which you can place the wire rack, for example.

You can remove the side racks (see “Cleaning and care of the oven – Side rack removal”).

# Features

## Universal tray and Wire Rack with anti-tip safety notches

The wireless roast probe antenna on the top right of the oven interior is at risk of damage when sliding in accessories.

When sliding in accessories, take care not to bang them against the wireless roast probe.

Universal tray HUBB 30-1:

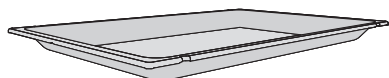

Wire Rack HBBR 36-2:

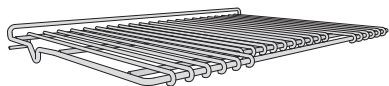

Safety notches are located on the short edges of the wire rack. These prevent the wire rack from being fully pulled out of the side racks when it only needs to be pulled partially out.

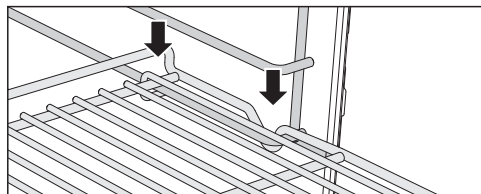

Always slide the wire rack into the rails of the side racks with the catches facing down.

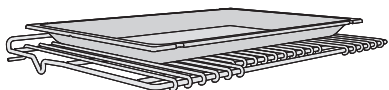

**Tip:** When using the universal tray, place it directly on the wire rack.

## FlexiClips with Wire Rack HFCBBR 36-3

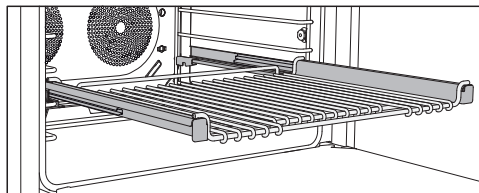

The FlexiClips with Wire Rack are mounted on the side racks and can be pulled completely out of the oven. This allows you to see the food easily.

The FlexiClips with Wire Rack are pushed onto the rails of a level and then locked into place.

The FlexiClips can support a maximum load of 33 lb (15 kg).

The FlexiClips with Wire Rack can be mounted on any shelf level.

## Installing and removing the FlexiClips with Wire Rack

**⚠** Danger of injury caused by hot surfaces.

The oven gets hot during operation. You could burn yourself on the heater elements, oven compartment, or accessories.

Allow the heating elements, oven compartment, and the accessories to cool down before installing or removing the FlexiClips with Wire Rack.

When installing or removing the FlexiClips, **do not** extend them.

- Hold the FlexiClips with Wire Rack with both hands and position them in front of the desired level.

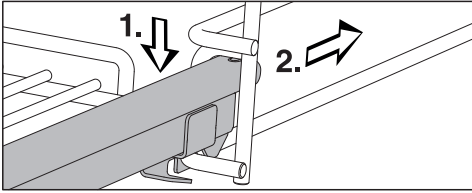

- Insert the FlexiClips with Wire Rack onto the level (1.) and slide them along the struts of the level (2.) until they click into place.

If the FlexiClips are difficult to pull out after installing, you may need to pull firmly on them once to release them.

**Tip:** When using the universal tray, place it directly on the FlexiClips with Wire Rack.

To remove the FlexiClips with Wire Rack, proceed as follows:

- Push the FlexiClips with Wire Rack in all the way.

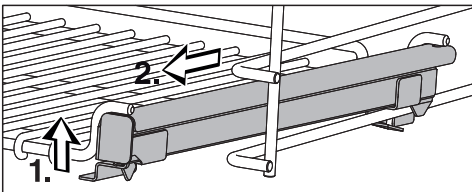

- Lift the front of the FlexiClips with Wire Rack on both sides (1.) and pull them out of the level (2.).

## Round baking pans



The **solid round baking pan HBF 27-1** is suitable for cooking pizzas, flat cakes, sweet and savory tarts, baked desserts, flat bread, and can also be used for frozen cakes.

The **perforated round baking pan HBFP 27-1** has been specially developed for baked goods made from fresh yeast dough, and for baking bread and rolls. The tiny perforations assist in browning the underside of baked goods.

They can also be used for dehydrating or drying food.

The enameled surface of both baking pans has been treated with PerfectClean.

- Insert the wire rack and place the round baking pan on the rack.

## Perforated Gourmet Baking Tray HBBL 71

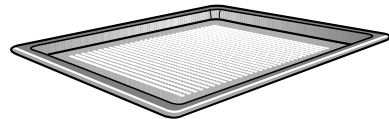

The perforated Gourmet Baking Tray has been specially developed for preparing baked goods made from fresh yeast doughs.

The tiny perforations assist in browning the underside of baked goods.

The Gourmet Baking Tray can also be used for dehydrating or drying food.

The enameled surface has been treated with PerfectClean.

The **round perforated baking tray HBFP 27-1** can be used for these purposes.

- Insert the wire rack and place the perforated gourmet baking tray on the wire rack.

# Features

## Broiling and roasting insert HGBB 30-1

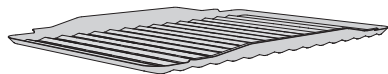

The broiling and roasting insert fits in the universal tray.

The tray will collect meat juices and stop them from burning so that they can be used for making gravy and sauces.

The enameled surface has been treated with PerfectClean.

## HUB Gourmet Casserole Dishes HBD Gourmet Casserole Dish lids

Miele Gourmet Casserole Dishes can be placed directly on the wire rack. The surface of the casserole dishes has a non-stick coating.

Gourmet Casserole Dishes are available in different depths. The width and the height are the same.

Suitable lids are available separately. Please quote the model designation when ordering.

**Depth:**  
**8 1/2" (22 cm)**

HUB 62-22\*

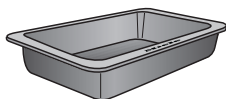

HBD 60-22

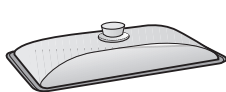

**Depth:**  
**13 3/4" (35 cm)**

HUB 62-35\*

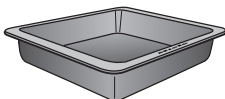

HBD 60-35

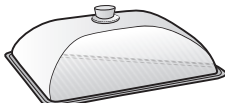

## Wireless precision probe

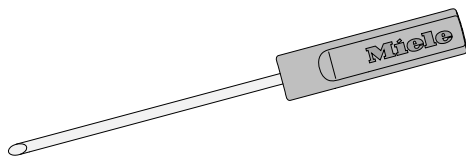

Your oven is supplied with a wireless precision probe which enables you to accurately monitor the temperature during cooking processes (see "Roasting – Probe"). The probe is stored in a storage sleeve in the front frame when not in use.

## Accessories for cleaning and care

- Opener  
The opener is used for removing the cover from the oven lighting.

## Gas cooktop safety features

### Automatic re-ignition

Your gas cooktop features automatic re-ignition. If a gas flame is extinguished, e.g., by food boiling over or by a draft, the flame automatically re-ignites.

\* Suitable for use on induction cooktops



## Oven safety features

- **System lock**   
(see “Settings – Safety”)
- **Sensor lock**  
(see “Settings – Safety”)
- **Cooling fan**  
(see “Settings – Cooling fan run-on”)
- **Safety shut-off**  
This safety shut-off is activated automatically if the oven has been operating for an unusually long period of time. The period of time will depend on the particular operating mode being used.
- **Ventilated door**  
The oven door is made of glass panes that have a heat-reflective coating on part of their surface. When the oven is operating, air is passed through the door to keep the outer pane cool. You can remove the door for cleaning purposes (see “Cleaning and care of the oven”).
- **Door locking** for Self Clean  
At the beginning of a Self Clean program, the door will lock for safety reasons. The door will only unlock when the temperature in the oven compartment has dropped to below 535°F (280°C).

## PerfectClean treated surfaces

PerfectClean surfaces have very good non-stick properties making them exceptionally easy to clean.

Food can be easily removed from these surfaces. Soiling from baking and roasting can also be easily removed from these surfaces.

However, do not use ceramic knives as these will scratch the PerfectClean surface.

Read the instructions in “Cleaning and care of the oven” to retain the benefits of the non-stick properties and easy cleaning.

PerfectClean treated surfaces:

- Universal tray
- Broiling and roasting insert
- Perforated Gourmet Baking Tray
- Round baking pan
- Round perforated baking pan

## Self-Clean-ready accessories

See “Cleaning and care of the oven” for more information.

The following accessories can be left in the oven compartment during the Self Clean program:

- Side runners
- FlexiClips with Wire Rack
- Wire rack

# Before first use

---

## Miele@home

Your oven is equipped with an integrated WiFi module.

To use this feature, you will need:

- a Wi-Fi network
- the Miele app
- a Miele user account You can create a user account via the Miele app.

The Miele app will guide you as you connect your oven to your home WiFi network.

The extra data plate for connecting the oven to your WiFi is located on the front frame of the oven.

Once your oven is connected to your WiFi network, you can use the app to carry out various activities, such as:

- Call up information on the operating status of your oven
- Retrieve information on cooking processes that are in progress
- Stop cooking programs that are in progress

Connecting your oven to your WiFi network will increase energy consumption, even when the oven is turned off.

Make sure that the signal of your Wi-Fi network is sufficiently strong in the place where your range is installed.

## Availability of the WiFi connection

The WiFi connection shares a frequency range with other appliances (including microwave ovens and remote control toys). This can cause sporadic or even complete connection failures.

Therefore, the availability of featured functions cannot be guaranteed.

## Miele@home availability

The ability to use the Miele app depends on the availability of the Miele@home service in your country.

The Miele@home service is not available in every country.

For information about availability, please visit [www.miele.com](http://www.miele.com).

## Miele App

The Miele App is available to download free of charge from the Apple App Store® or from the Google Play Store™.



## Basic settings

You must make the following settings before starting up for the first time. You can change these settings again at a later time (see “Settings”).

 Danger of injury caused by hot surfaces.  
The range gets hot during operation. For safety reasons, only use the range when it has been fully installed.

The range will turn on automatically when it is connected to the power supply.

## Setting the language

- Select the desired language.

If you have accidentally selected a language that you don't understand, proceed as described in “Settings – Language ▾”.

## Setting the location

- Select the required location.

## Setting up Miele@home

Set up Miele@home? will appear on the display.

- To set up Miele@home immediately, select *Continue*.
- To set it up at a later date, select *Skip*. See “Settings – Miele@home” for information on setting up at a later date.
- To set up Miele@home immediately, select the connection method you want to use.

You will then be guided by the display and the Miele app.

## Setting the date

- Set the day, then the month, and finally the year.
- Confirm with *OK*.

## Setting the time

- Set the time of day in hours and minutes.
- Confirm with *OK*.

## Setting the voltage

 The set voltage variant must match the voltage of the domestic electrical supply in order to avoid the risk of damage to the oven. Confirm the voltage before setting. If in any doubt, consult a qualified electrician.

- Select the voltage variant.
- Confirm with *OK*.

## Completing the commissioning process

- Follow any further instructions on the display.

The appliance is now ready for use.

## Before first use

---

### Cleaning the cooktop before heating it up for the first time

The metal components have a protective coating. The cooktop may have a slight odor and give off vapor when heated up for the first time.

Any odors or vapors given off do not indicate a faulty connection or appliance and they are not hazardous to health.

- Remove any adhesive labels or protective films from the cooktop.
- Before heating the cooktop up, wipe with a damp cloth to remove any dust or bits of packaging and then dry the surface.
- Clean all removable parts of the burners with a solution of warm water and a little liquid dish soap applied with a soft sponge. Dry all parts thoroughly after cleaning and then reassemble the burners (see “Gas cooktop cleaning and care”).
- Remove the grill and clean it with a soft sponge, warm water, and a small amount of liquid dish soap. Then dry the grill.

### Seasoning the griddle plate

You need to season the griddle plate before you can cook food on it. This prevents food from sticking to it and protects the surface from moisture.

Ensure that the kitchen is well ventilated while the appliance is being heated up for the first time.

Close doors to other rooms to prevent the odor spreading throughout the house.

- Set the griddle plate to *High* for 30 minutes.
- Switch off the griddle plate after 30 minutes.
- Let the griddle plate cool down.

The griddle plate will be permanently discolored after heating up. The discoloration can increase over time. This will not affect functionality in any way.

- Pour 1 teaspoon of vegetable oil that can be heated to a high temperature in the middle of the cooled griddle plate.
- Distribute the oil with a paper towel. Do not oil the corners.

Do not use too much oil. Excess oil leaves behind a rubbery substance that needs to be removed.

- Remove excess oil with a paper towel.
- Set the griddle plate to *High* until the oil starts to smoke.
- Switch off the griddle plate.
- When the griddle plate has cooled down sufficiently that it can be touched, remove excess oil.
- Repeat the process once the griddle plate has cooled down completely.



### Heating up the oven for the first time and rinsing the steam injection system

New ovens may have a slight odor when they are heated up for the first time. Heating up the oven for at least an hour with nothing in it will eliminate the odor. It is a good idea to rinse out the steam injection system at the same time.

Ensure that the kitchen is well ventilated while the appliance is being heated up for the first time. Close doors to other rooms to prevent the odor spreading throughout the house.

- Remove any adhesive labels or protective films from the ovens and accessories.
- Before heating the oven up, wipe the interior with a damp cloth to remove any dust or bits of packaging that may have accumulated in the oven compartment.
- Insert the FlexiClips with Wire Rack into the side racks and place all trays and wire racks in the oven.
- Turn the oven on using the  On/Off button.

The main menu will appear.

- Select Operating Modes .
- Select Moisture Plus .
- Select Moisture Plus + Conv Bake .

350°F (160°C) will appear as a recommended value.

- Set the highest possible temperature.
- Select Continue.

- Select Automatic.
- Select Continue.

The oven heating, lighting, and cooling fan will turn on.

After a short time, a burst of steam will be released automatically.

 Risk of injury caused by steam. The steam escaping is very hot. Do not open the door when the burst of steam is being released.

Heat up the oven for at least an hour.

- After at least an hour, turn the oven off with the  On/Off button.

### Cleaning the oven compartment after heating it up for the first time

 Risk of injury caused by hot surfaces. The oven gets hot during operation. You could burn yourself on the heating elements, oven compartment, or accessories. Allow the heating elements, oven compartment, and accessories to cool before manual cleaning.

- Take all accessories out of the oven compartment and clean it by hand (see “Cleaning and care of the oven”).
- Clean the oven compartment with warm water and liquid dish soap, applied with a soft sponge or microfiber cloth.
- Dry all surfaces with a soft cloth.

Leave the oven door open until the oven compartment is completely dry.

# Using the gas cooktop

## Energy-saving tips

- Cook in covered pots and pans if possible. Doing so will prevent unnecessary heat loss.

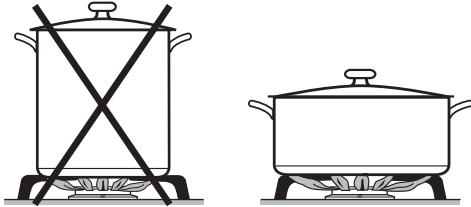

- Wide, shallow pots are preferable to tall, narrow ones. They will heat up faster.
- Cook with as little water as possible.
- Once food has come to a boil or the pan is hot for frying, reduce the heat to a lower power setting.
- Use a pressure cooker to reduce cooking durations.

## Suitable cookware

- Select cookware that fits the size of the burner:  
Large diameter = large burner  
Small diameter = small burner
- Using cookware that is too large can cause the flames to spread out and damage the surrounding countertop or other appliances. Choosing the right cookware size improves efficiency.
- Any cookware that has a diameter smaller than the burner grate or which does not rest in a stable position on the grate (without wobbling) is dangerous and should not be used.

- Unlike cookware that is used on an electric cooktop, the bottom of cookware used on a gas cooktop does not have to be flat to deliver effective cooking performance.
- When purchasing pots and pans, keep in mind that the diameter indicated is typically the top diameter, not the bottom diameter.
- All heat-resistant cookware is suitable for use.
- Cookware with a thick bottom is preferable, as it distributes heat more evenly. Cookware with a thin bottom may cause food to overheat in certain spots. To avoid this, stir the food frequently.
- Always place the cookware on the grates supplied. Do not place cookware directly on the burners.
- Position the cookware on the burner grate so that it cannot tip. There is always a possibility of a slight tilt, despite the proper position.
- Do not use pots or pans that have bottoms with pronounced edges.



 Fire hazard due to overheated food.  
Unattended food can overheat and ignite.  
Do not leave the cooktop unattended whilst it is being used.

## Switching on the burner

Do not turn the control knob clockwise past the *Off* position.

When a control knob is activated, a spark is developed automatically on all burners. This is normal and does not indicate a fault.

You may notice a brief re-ignition (1–2 clicks) when turning on the appliance, e.g., because of a draft.

- Push in the control knob for the burner required and turn it counterclockwise to *High*.

The ignitor “clicks” and ignites the gas.

- If the burner fails to ignite, turn the control knob to the *Off* position. Aerate the room or wait at least 1 minute before trying again.
- If the burner does not ignite the second time, turn the control knob back to *Off* and see “Frequently asked questions”.

## Switching on during a power failure

 If there has been a power failure, the automatic re-ignition feature will not work properly.

Operate the cooktop only under supervision. If the burner has not ignited or the flame goes out, turn the control knob to *Off*.

## Normal and power burners

In case of a power failure, the flame can be ignited manually.

- Push in the control knob and turn it counterclockwise to *High*.
- Light the emerging gas/air mixture with a match.

## Grill

 Danger of injury caused by manually igniting the burner during a power failure!  
Never operate the grill during a power failure.

- Turn the grill control knob to *Off*.

## Griddle plate

 Danger of injury caused by manually igniting the burner during a power failure!  
Never operate the griddle plate during a power failure.

- Turn the control knob for the griddle plate to *Off*.

## Adjusting the flame

The burners can be variably adjusted between the lowest and highest flame settings.

# Using the gas cooktop

As the outer part of the flame is much hotter than the center, the tips of the flames should stay beneath the pan base. Flame tips which extend beyond the sides of the pan merely warm up the air in the room and can damage pan handles and increase the risk of injury.

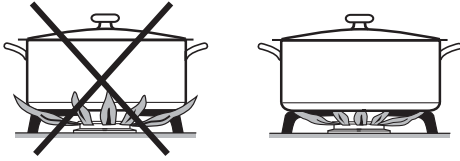

- Adjust the flame so that it does not spread out beyond the sides of the pan.

## Appearance of the gas flames

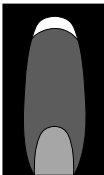
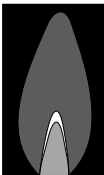
	<b>Yellow flames</b> Contact Customer Service.
	<b>Yellow tips on the outer cone</b> Normal for LP gas
	<b>Pale blue flames</b> possibly with yellow tips on the inner cone Normal for natural gas

## Switching off the burner

Do not turn the control knob clockwise past the *Off* position.

- Turn the control knob clockwise to the *Off* position.

This stops the flow of gas and the flame goes out.

## Using the grill

### Switching on the grill

Always observe USDA food safety guidelines.

- Push in the grill control knob and turn it counterclockwise to *High* until the burner ignites.
- If the burner fails to ignite, turn the control knob to the *Off* position. Aerate the room or wait at least 1 minute before trying again.
- If the burner does not ignite the second time, turn the control knob back to *Off* and see “Frequently asked questions”.
- Preheat the grill for approx. 10 minutes.
- Set the power level you want.

Do not use cooking utensils on the grill.



# Using the gas cooktop

## Tips for grilling



### Risk of fire!

Do not leave the appliance unattended while cooking.

- Always preheat the grill for 10 minutes before use. Select the setting that you are going to cook with.
- Pat wet food dry with a paper towel to avoid spitting when grilling.
- To prevent meat drying out, do not season with salt until after it has been grilled.
- Select lean meat or cut the fat off prior to grilling. Drops of fat can ignite.
- If drops of fat ignite, use long barbecue tongs to immediately move the food to another area of the grill or remove it completely.
- Remove the skin from chicken breasts and thighs to minimize flare-ups.
- Cover the food with the marinade halfway through grilling.
- Leave the grill on for approx. 10 minutes after you have finished grilling. This will make the grill easier to clean once it has cooled down.

The grill is heated by means of a ceramic burner which transfers intense heat to the food. Searing helps to keep juices in the meat. The temperature of the grill can be variably adjusted between the lowest and highest flame settings.

The grill and griddle plate will be switched off as soon as you start the Self Clean program on the oven.

The grill and griddle plate cannot be turned on during Self Clean.

## Using the griddle plate

During heating, an LP gas griddle plate can emit a buzzing or growling sound. This is not an error.

## Switching on the griddle plate

Always observe USDA food safety guidelines.

- Push in the griddle plate control knob and turn it counterclockwise to *Low* until the burner ignites.
- If the burner fails to ignite, turn the control knob to the *Off* position. Aerate the room or wait at least 1 minute before trying again.
- If the burner does not ignite the second time, turn the control knob back to *Off* and see “Frequently asked questions”.
- Preheat the griddle plate for approx. 20 minutes.
- Set the power level you want.

# Using the gas cooktop

## Tips for griddling

Clean the griddle plate before every use with a damp sponge to remove dust particles or other residues.

- Always preheat the griddle plate for 20 minutes before use. Select the setting that you are going to cook with.
- Pat wet food dry with a paper towel to avoid spitting.
- To prevent meat drying out, do not season with salt until after it has been cooked.
- Very little fat is required for cooking on the griddle plate and no fat is required for marinated food. If you are using fat, do not put it onto the griddle plate until the griddle plate is hot.
- Use only fats and oils that can withstand high temperatures.
- We recommend that you marinate the food to be cooked. This will improve the flavor of the food.

The griddle plate is equipped with a thermostat that maintains an even temperature.

The griddle plate must be seasoned first to prevent food from sticking to it (see “Before using for the first time – Seasoning the griddle plate”). The temperature of the griddle plate can be variably adjusted between the lowest and highest flame settings.

The grill and griddle plate will be switched off as soon as you start the Self Clean program on the oven.

The grill and griddle plate cannot be turned on during Self Clean.



## Griddle plate settings

Power level	Food
<i>Low</i>	Simmering sauce
	Keeping warm
•*	Eggs
	Bacon
	French toast
•* <i>-High</i>	Fish
	Pancakes
	Sausages
	Hash browns
	Vegetables
<i>High</i>	Burgers
	Steaks
	Stir fry

\* The symbol without a label indicates a medium power level.

## Energy-saving tips

### Cooking programs

- If possible, use the automatic programs for cooking food.
- Remove all accessories from the oven that are not required for a cooking process.
- If a temperature range is given, it is best to select the lower temperature and check the food after the shortest cooking time given.
- Preheat the oven only if instructed to do so in the recipe.
- Try not to open the door when cooking.
- It is best to use dark bakeware and cooking containers with a matte finish made of non-reflective materials (enameled steel, heat-resistant glass, non-stick coated cast aluminum). Shiny materials such as stainless steel or aluminum reflect the heat and therefore can give a more uneven result. Do not cover the oven floor or the wire rack with heat-reflecting aluminum foil.
- Monitor cooking durations to avoid wasting energy when cooking. Set the cooking duration, or use a probe if you have one.
- Most food can be cooked using Convection Bake/Convection Roast . Because the blower distributes the heat in the oven compartment straight away, it allows you to use a lower temperature than you would with Surround . It also enables you to cook on multiple shelf levels at the same time.
- Convection Broil  is the best operating mode for broiled dishes. Lower temperatures can be used than with other broil modes that use the maximum temperature setting.
- Whenever possible you should cook several dishes at the same time. Place them next to each other in the oven or on different shelf levels.
- Dishes which you are unable to prepare at the same time should, if possible, be cooked one after the other in order to make use of existing heat in the oven.

# Using the oven

---

## Residual heat utilization

- The temperature in cooking programs using temperatures above 285°F (140°C) which take longer than 30 minutes to cook can be turned down to the lowest possible temperature about 5 minutes before the end of cooking. The residual heat in the oven is sufficient for cooking the food until it is done. However, do not turn the oven off (see “IMPORTANT SAFETY INSTRUCTIONS”).
- If you have set a cooking duration for a cooking program, the oven heating elements will turn off automatically shortly before the end of cooking. The residual heat in the oven is sufficient to complete the cooking process.
- It is best to start the Self Clean program immediately after a cooking program. The residual heat in the oven will help reduce the amount of energy required.

## Settings

- Select the **Display | QuickTouch | Off** setting for the control elements in order to reduce energy consumption.
- Select the **Lighting | Off** or “On” for 15 seconds setting for the oven interior lighting. You can turn the oven interior lighting on again at any time by tapping the *Light* sensor button.

## Energy-saving mode

The oven will turn itself off automatically to save energy if a program is not being run and no controls have been operated. The time of day will appear on the display or the display will remain dark (see “Settings”).

- Turn the oven on.

The main menu will appear.

- Place the food in the oven.
- Select Operating Modes .
- Select the operating mode you want to use.

The operating mode and recommended temperature will appear.

- Adjust the recommended temperature, if necessary.

Otherwise, the recommended temperature will be accepted within a few seconds. You can change the temperature later by selecting the temperature indicator.

- Confirm with *OK*.

The required and the actual temperature will appear and the preheating phase will begin.

You will see the temperature rising on the display. An audible signal will sound when the set temperature is reached for the first time.

- After the cooking program, select *Finish*.
- Take the food out of the oven.
- Turn the oven off.

## Changing values and settings for a cooking program

Depending on the operating mode, as soon as a cooking program is in progress, you can change the values or settings for this program.

Depending on the operating mode, you can change the following settings:

- Temperature
- Duration
- Ready at
- Start at
- Booster
- Preheat
- Crisp function

## Changing the temperature and core temperature

Via Settings | Recommended temperatures, you can permanently adjust the recommended temperature to suit your cooking preferences.

The  core temperature only appears if you are using the probe (see “Roasting – Probe”).

- Tap the temperature display.
- Change the temperature and the  core temperature as required.
- Confirm with *OK*.

The cooking program will resume with the new target temperatures.

# Using the oven

## Setting additional durations

Cooking results can be adversely affected if there is a long delay between the food being placed in the oven and the start of cooking. Fresh food can change color and even spoil.

When baking, the cake mixture or dough can dry out, and the raising agents can lose their effectiveness.

Select as short a time as possible until the start of the cooking process.

You have placed the food in the oven, selected an operating mode and the required settings such as the temperature.

By entering **Duration**, **Ready at** or **Start at**, you can automatically turn the cooking program off or on and off.

### - Duration

Enter the required cooking duration for the food. The oven heating will turn off automatically once the cooking duration has elapsed. The maximum cooking duration that can be set depends on the operating mode that you have selected.

### - Ready at

Specify when you want the cooking program to finish. The oven will turn off automatically at the time you have set.

### - Start at

This function will only appear in the menu if you have set a **Duration** or **Ready at** time. With **Start at**, you have to specify when you want the cooking program to start. The oven will turn on automatically at the time you have set.

- Select  $\oplus$  or **Timer**.
- Set the required times.
- Confirm with **OK**.

## Changing set durations

- Select  $\ominus$ , the duration, or **Timer**.
- Select the time you want and change it.
- Confirm with **OK**.

These settings will be deleted in the event of a power failure.

## Deleting the set cooking durations

- Select  $\ominus$ , the duration, or **Timer**.
- Select the time you want.
- Select **Delete**.
- Confirm with **OK**.

If you delete **Duration**, the set durations for **Ready at** and **Start at** are also deleted.

If you delete **Ready at** or **Start at**, the cooking program will start using the cooking duration set.

## Canceling a cooking program

If you cancel a cooking program, the oven heating and lighting will turn off. Any cooking durations set will be deleted.

## Canceling a cooking program without a set cooking duration

- Select **Finish**.

The main menu will appear.

## Canceling a cooking program with a set cooking duration

- Select Cancel.

Cancel program? will appear.

- Select Yes.

The main menu will appear.

## Preheating the oven





The Booster function is used to quickly preheat the oven compartment in some operating modes.

The Preheat function can be used with any operating mode and has to be turned on separately for each cooking program.

If you have set a cooking duration, it will only start to count down when the target temperature is reached and you have placed the food in the oven.

The appliance only needs to be preheated in a few cases.



- You can place most dishes in the cold oven compartment to make use of the heat produced during the preheating phase.
- Preheat the oven when cooking the following food with the following operating modes:

- Dark bread dough, as well as Roast Beef and fillets with the Convection Bake/Convection Roast , Moisture Plus , and Surround  operating modes
- Cakes and pastries with a short cooking duration (approx. 30 minutes or less) as well as delicate items (e.g., sponge) with the Surround  operating mode (without the Booster function)

## Booster

The Booster function is used to quickly preheat the oven.

This function is turned on as the factory default setting for the following operating modes (Settings | Booster | On):

- Convection Bake 
- Convection Roast 
- Surround 
- Auto Roast 
- Moisture Plus 

If you set a temperature above 210°F (100°C) and the Booster function is turned on, a rapid preheating phase heats the oven compartment to the set temperature. The browning/broiling element and the ring heating element come on together with the hot air blower.

Delicate items (e.g., sponge cake or cookies) will brown too quickly on the top if the Booster function is used.

Turn off the Booster function for these items.

# Using the oven

---

## Turning Booster on or off for a cooking program

If you have selected the **Booster | On** setting, you can turn the function off separately for a cooking program.

On the other hand, you can also turn on the function separately for a cooking program if you have selected the **Booster | Off** setting.

Example: You have selected an operating mode and the required settings such as the temperature. You want to turn off the **Booster** function for this cooking program.

- Drag down the pull-down menu.

**Booster** is highlighted in orange.

- Select **Booster**.

Depending on the color scheme, **Booster** is highlighted in either black or white.

- Close the pull-down menu.

The **Booster** function is turned off during the preheating phase. Only the heating elements for the selected operating mode are used to preheat the oven compartment.

## Preheat

The appliance only needs to be preheated in a few cases.

You can place most dishes in the cold oven compartment to make use of the heat produced during the preheating phase.

If you have set a cooking duration, it will only start to count down when the target temperature is reached and you have placed the food in the oven.

Start the cooking program immediately without delaying the start time.

## Turning Preheat on

The **Preheat** function can be used with any operating mode and has to be turned on separately for each cooking program.

Example: You have selected an operating mode and the required settings such as the temperature. You want to turn on the **Preheat** function for this cooking program.

- Drag down the pull-down menu.

Depending on the color scheme, **Preheat** is highlighted in either black or white.

- Select **Preheat**.

**Preheat** is highlighted in orange.

- Close the pull-down menu.

The following message will be displayed with a time: **Place food in oven at .** The oven compartment is heated to the set temperature.

- As soon as you are prompted to do so, place the food in the oven.
- Confirm with **OK**.



## Crisp function

It is a good idea to use the Crisp function (moisture reduction) when cooking food which has a moist topping, e.g., quiche, pizza, tray bakes with fresh fruit toppings, or muffins.

Poultry in particular gets a nice crisp skin with this function.

### Turning Crisp function on

The Crisp function can be used with any operating mode and has to be turned on separately for each cooking program.

You have selected an operating mode and the required settings such as the temperature.

You want to turn on the Crisp function for this cooking program.

- Drag down the pull-down menu.

Depending on the color scheme, Crisp function is highlighted in either black or white.

- Select Crisp function.

Crisp function is highlighted in orange.

- Close the pull-down menu.

The Crisp function is turned on.

## Changing the operating mode

You can change to another operating mode during a cooking program.





- Tap the symbol for the selected operating mode.
- If you have set a cooking duration, confirm the **Cancel program?** message with **Yes**.
- Select the new operating mode.

The new operating mode will appear on the display with its corresponding recommended values.

- Set the values for the cooking program and confirm with **OK**.

# Settings

## Settings overview

Menu option	Available settings
Language 	...   deutsch   english   ... Location
Time	Display On*   Off   Night dimming Clock type Analog*   Digital Clock format 24 h   12 h (am/pm)* Set
Date	
Lighting	On "On" for 15 seconds* Off
Start screen	Main menu* Operating modes Automatic Programs Special Modes Favorites MyMiele
Display	Brightness  Color scheme Bright   Dark* QuickTouch On   Off*
Volume	Buzzer Tones  Keypad Tone  Welcome Melody On*   Off
Units of Measurement	Temperature °C   °F*
Booster	On* Off

\* Factory default

Menu option	Available settings
Recommended temperatures	
Self clean	With reminder Without reminder*
Cooling fan run-on	Time controlled Temperature controlled*
MotionReact	Switch the light on during cooking program*   always on   Off Switch the appliance on On   Off* Acknowledge buzzer On*   Off
Safety	System Lock  On   Off* Sensor Lock On   Off*
Miele@home	Activate Deactivate Connection status Set up again Reset Set up
Remote Control	On* Off
SuperVision	SuperVision display On   Off* Display in standby On*   Only if there is a fault Appliance list Display this Appliance   Buzzer Tones
RemoteUpdate	On* Off

\* Factory default

# Settings

Menu option	Available settings
Lift-up panel	Automatic Manual*
Electrical version	208V / 60Hz 220V / 60Hz 240V / 60Hz
Probe	
Calibrate temperature	■■■■■■■■
Software version	
Legal information	Open Source Licenses
Showroom Program	Demo Mode On   Off*
Factory default	Appliance settings Favorites MyMiele Recommended temperatures

\* Factory default

## Opening the “Settings” menu

In the  Settings menu, you can personalize your oven by adapting the factory default settings to suit your requirements.

From the main menu:

- Select  Settings.
- Select the setting you want.



You can check settings or change them.

You cannot change settings while a cooking program is in progress.

## Language

You can set your language and location.

After selecting and confirming your choice, the language you have selected will appear on the display.

**Tip:** If you have accidentally selected a language that you don't understand, select  in the main menu. Follow the  symbol to get back to the Language  submenu.

## Time

### Display

Select how you want the time of day to show on the display when the oven is turned off:

- On  
The time is always visible on the display.  
If you also select the Display | QuickTouch | On setting, all sensor buttons will react to touch straight away and the proximity sensor will automatically detect when you

approach the display.

If you also select the Display | QuickTouch | Off setting, the oven has to be turned on before it can be used.

- Off  
The display appears dark to save energy. The oven has to be turned on before you can use it.
- Night dimming  
To save energy, the time only shows on the display between 5:00 a.m. and 11:00 p.m. The display remains dark at all other times.

### Clock type

The time of day can be displayed as Analog (with a clock face) or Digital (h:min) format.

With the digital display, the date is also shown.

### Clock format

The time of day can be displayed in the 24 or 12-hour format (24 h or 12 h (am/pm)).

### Set

Set the hours and the minutes.

**Tip:** If no cooking program is in progress, tap the time in the header to change it.

If there is a power failure, the current time of day will reappear once the power has been restored. The time of day is saved for approx. 150 hours.

If the oven has been connected to a WiFi network and signed into the Miele app, the time will be synchronized based on the location setting in the Miele app.

# Settings

---

## Date

Set the date.

When the oven is turned off, the date will only appear on the display if the **Time | Clock type | Digital** setting has been selected.

## Lighting

- On  
The oven interior lighting is turned on during the entire cooking process.
- "On" for 15 seconds  
The oven interior lighting turns off 15 seconds after a cooking process has begun. Press the *Light* sensor button to turn the oven interior lighting on again for 15 seconds.
- Off  
The oven interior lighting is turned off. Press the *Light* sensor button to turn the oven interior lighting on for 15 seconds.

## Start screen

The oven is set at the factory for the main menu to appear when the oven is turned on. You can change this default setting so that, for instance, the operating modes or MyMiele settings appear on the start screen (see "MyMiele").



This new start screen will then appear when the oven is next turned on.

Select the *Back* sensor button or follow the path in the header to get to the main menu.

## Display

### Brightness

The display brightness is represented by a segment bar.

-   
Maximum brightness
-   
Minimum brightness

### Color scheme

Choose between a light or dark color scheme for the display.

- Bright  
The display has a light background with dark characters.
- Dark  
The display has a dark background with light characters.

### QuickTouch

Select how the sensor buttons and the proximity sensor should respond when the oven is turned off:

- On  
If you have also selected the **Time | Display | On or Night dimming** setting, the sensor buttons and the proximity sensor will also respond when the oven is turned off.
- Off  
Regardless of the **Time | Display** setting, the sensor buttons and the proximity sensor only respond when the oven is turned on, as well as for a certain amount of time after turning it off.

## Volume

### Buzzer Tones

If audible signals are turned on, an audible signal will sound when the set temperature is reached and at the end of a set time.

The volume of the audible signals is represented by a segment bar.

- ■■■■■■■■  
Maximum volume

- □□□□□□  
Audible signals are switched off

### Keypad Tone

The volume of the tone that sounds each time you tap a sensor button is represented by a segment bar.

- ■■■■■■■■  
Maximum volume

- □□□□□□  
Keypad tone is turned off

### Welcome Melody

The melody that sounds when you tap the  On/Off button can be turned on or off.

## Units of Measurement

### Temperature

You can set the temperature in Celsius (°C) or Fahrenheit (°F).

### Booster

The **Booster** function is used to quickly preheat the oven.

- On  
The **Booster** function is automatically turned on during the preheating phase of a cooking program. The browning/broiling element, ring heating element, and fan all preheat the oven compartment to the required temperature at the same time.
- Off  
The **Booster** function is turned off during the preheating phase of a cooking program. Only the heating elements for the selected operating mode are used to preheat the oven compartment.

You can also use the pull-down menu to turn the **Booster** function on or off for a cooking program.

## Recommended temperatures

If you often cook with temperatures that differ from the default, the recommended temperatures can be changed.

After you select this option, a list of oven modes will appear on the display.

- Select the operating mode you want to use.

The recommended temperature will appear together with the range within which it can be changed.

- Change the recommended temperature.
- Confirm with **OK**.

You can also change the recommended temperature for the **Keep warm** function.

# Settings

---

## Self clean

You can set whether the recommendation for carrying out the Self Clean function will appear (With reminder) or will not appear (Without reminder).

## Cooling fan run-on

The cooling fan will continue to run for a while after the oven has been turned off to prevent any humidity building up in the oven, on the control panel, or in the cabinet carcass.

- Temperature controlled  
The cooling fan turns off when the temperature in the oven drops below approx. 160°F (70°C).
- Time controlled  
The cooling fan turns off after a period of about 25 minutes.

Condensation can damage the cabinet carcass and the countertop. This could lead to corrosion of the oven.

When keeping food warm in the oven, increasing the Time controlled setting can lead to condensation in the control panel.

Do not adjust the Time controlled setting and try not to leave food in the warm oven.

## Proximity sensor (MotionReact)

The proximity sensor detects when you approach the touch display, e.g., with your hand or body.

If you want the proximity sensor to respond even when the oven is turned off, select the Display | QuickTouch | On setting.

## Switch the light on

- during cooking program  
As soon as you approach the touch display during a cooking process, the oven interior lighting turns on. The oven interior lighting automatically turns off again after 15 seconds.
- always on  
As soon as you approach the touch display, the oven interior lighting turns on. The oven interior lighting automatically turns off again after 15 seconds.
- Off  
The proximity sensor does not respond when you approach the touch display. Press the *Light* sensor button to turn the oven interior lighting on for 15 seconds.

## Switch the appliance on

- On  
If the time is displayed, the oven will turn on and the main menu will appear as you approach the touch display.
- Off  
The proximity sensor does not respond when you approach the touch display. Turn the oven on using the  On/Off button.



## Acknowledge buzzer

- On  
As soon as you approach the touch display, the audible signals turn off.
- Off  
The proximity sensor does not respond when you approach the touch display. Turn the audible signals off manually.

## Safety

### System Lock

The system lock prevents the oven from being turned on inadvertently.

You can still set an alarm and a timer, as well as use the MobileStart function when the system lock is active.

The system lock will remain activated even after a power failure.

- On  
The system lock is now active. If you want to use the oven, touch  for at least 6 seconds.
- Off  
The system lock is now deactivated. You can use the oven as normal.

### Sensor Lock

The sensor lock prevents the cooking program from being turned off by mistake or settings from being changed. Once activated, the sensor lock prevents the sensor buttons and fields on the display from working for a few seconds after a program has been started, with the exception of the  On/Off button.

- On  
The sensor lock is active. Touch *OK* for at least 6 seconds to deactivate the sensor lock for a short period of time.
- Off  
The sensor lock is not active. All sensor buttons react to touch as normal.

## Miele@home

The oven is a Miele@home-compatible appliance with SuperVision functionality.

Your oven is equipped with a WiFi communication module and is suitable for wireless communication.

There are a number of ways of connecting your oven to your WiFi network. We recommend connecting your oven to your WiFi network using the Miele app or via WPS.

- Activate  
This setting is only visible if Miele@home is deactivated. The WiFi function is reactivated.
- Deactivate  
This setting is only visible if Miele@home is activated. Miele@home remains set up; the WiFi function is turned off.
- Connection status  
This setting is only visible if Miele@home is activated. The display shows information such as the WiFi reception quality, network name, and IP address.

# Settings

---

- Set up again  
This setting is only visible if a WiFi network has already been set up. Reset the network settings and set up a new network connection straight away.
- Reset  
This setting is only visible if a WiFi network has already been set up. The WiFi function is deactivated and the WiFi connection will be reset to the factory default. You must set up a new WiFi connection to be able to use Miele@home.  
Reset the network settings if you are disposing of or selling your oven, or if you are putting a used oven into operation. This is the only way to ensure that all personal data has been removed and the previous owner will no longer be able to access the oven.
- Set up  
This setting is only visible if no WiFi connection has been set up yet. You must set up a new WiFi connection to be able to use Miele@home.

## Remote Control

If you have installed the Miele app on your mobile device, have access to the Miele@home system, and have activated the remote control function (On), you can use the MobileStart function to retrieve information on oven cooking programs that are in progress or to end a program in progress.

### Activating MobileStart

- Select the *Remote* sensor button to activate MobileStart.

The *Remote* sensor button lights up. You can operate your oven remotely with the Miele app.

Directly operating on the oven takes priority over operating it via the remote control function on the app.

You can use MobileStart as long as the *Remote* sensor button is lit up.

## SuperVision

The oven is a Miele@home-compatible appliance with SuperVision functionality for monitoring other domestic appliances in the Miele@home system.

The SuperVision function cannot be activated until the Miele@home system has been set up.

### SuperVision display

- On  
The SuperVision function is turned on. The  symbol will appear in the top right-hand corner of the display.
- Off  
The SuperVision function is turned off.

## Display in standby

The SuperVision function is also available when the oven is in standby. However, the time-of-day display must be turned on (Settings | Time | Display | On).

- On  
Active domestic appliances that are signed on to the Miele@home system are always displayed.
- Only if there is a fault  
Only faults on active domestic appliances are displayed.

## Appliance list

All domestic appliances signed on to the Miele@home System are displayed. Once you have selected an appliance, you can access further settings:

- Display this Appliance
  - On  
The SuperVision function for this appliance is turned on.
  - Off  
The SuperVision function for this appliance is turned off. The appliance is still signed on to the Miele@home system. Faults are displayed, even if the SuperVision function for the appliance has been turned off.
- Buzzer Tones  
You can select whether the audible signals are turned on (On) or turned off (Off) for this appliance.

## RemoteUpdate

The RemoteUpdate menu option is only displayed and can only be selected if the requirements for using Miele@home have been met (see “Before using for the first time – Miele@home”).

The RemoteUpdate function is used for updating the software in your oven. If an update is available for your oven, it will automatically download it. Updates will not be installed automatically. They must be initiated manually.

If you do not install an update, you can continue to use your oven as usual. However, Miele recommends installing updates.

## Activating/deactivating

The RemoteUpdate function is activated as standard. Available updates will be downloaded automatically but will only be installed if you initiate installation manually.

Deactivate RemoteUpdate if you do not want any updates to be downloaded automatically.

## Running a RemoteUpdate

Information about the content and scope of an update is provided in the Miele app.

A message will appear on your oven display if a software update is available.

You can install the update immediately or postpone this until later. When the oven is turned on again, you will be reminded about the update.

# Settings

---

Deactivate RemoteUpdate if you do not want to install the update.

The update may take several minutes.

Please note the following information about the RemoteUpdate function:

- You will only receive a message when an update is available.
- Once an update has been installed, it cannot be undone.
- Do not turn the oven off during the update. Otherwise, the update will be aborted and will not be installed.
- Some software updates can only be carried out by Miele Customer Service.

## Lift-up panel

Regardless of the setting selected, as soon as you start the Self Clean program the lift panel will go down automatically.

- Automatic

The lift panel raises automatically as soon as you turn the range on.

The lift panel goes down automatically as soon as you turn the range off.

- Manual

Touch the *Lift Panel* sensor button to raise and lower the lift panel.

## Electrical version

You can set the voltage variant. The setting must correspond to the voltage of your domestic electrical supply.

## Probe

The oven is factory set to automatically detect the probe.

If you have purchased a new Miele probe, you must enter a 12-digit code for this setting. You can then start using the probe.

- Follow the description supplied with the replacement part.

## Calibrate temperature

You can change the temperature in increments in all operating modes and automatic programs so that it is higher or lower in the oven compartment than displayed.

The temperature calibration is represented by a bar with seven segments.



If all of the segments are filled, the oven compartment temperature is much higher than displayed. If one segment is filled, the oven compartment temperature is much lower than displayed.

## Software version

The software version menu option is for use by Miele Technical Service. You do not need this information for domestic use.

- Confirm with *OK*.

## Legal information

You can find an overview of the integrated open-source components under Open Source Licenses.

- Confirm with *OK*.

## Showroom Program

This function enables the oven to be demonstrated in showrooms without heating up. Do not activate this setting for domestic use.

## Demo Mode

If you have Demo mode activated, Demo mode is active. The appliance will not heat up **will appear when you turn on the oven.**

- On  
Touch *OK* for at least 4 seconds to activate Demo mode.
- Off  
Touch *OK* for at least 4 seconds to deactivate Demo mode. You can use the oven as normal.

## Factory default

- Appliance settings  
Any settings that have been altered will be reset to the factory default settings.
- Favorites  
All Favorites will be deleted.
- MyMiele  
All MyMiele entries will be deleted.
- Recommended temperatures  
Any recommended temperatures that have been changed will be reset to the factory default settings.

# Alarm + Timer

---

Using the *Timer* sensor button, you can set a timer (e.g., for boiling eggs) or an alarm for a specific time.

Two alarms, two timers, or an alarm and a timer can be set simultaneously.

## Using the Alarm function

The  alarm can be used to specify a particular time for an audible signal to sound.

### Setting the alarm

If the *Display | QuickTouch | Off* setting is selected, you will need to turn the oven on before setting the alarm. The alarm time will then appear on the display when the oven is turned off.

- Select the *Timer* sensor button.
- Select  Alarm.
- Set the time for the alarm.
- Tap *Close* to confirm.

When the oven is turned off, the alarm time and  will appear instead of the time of day.

If you are cooking at the same time or if you are in a different menu, the alarm time and  will appear in the top right-hand corner of the display.

At the specified time for the alarm,  will flash on the display next to the time and an audible signal will sound.

- Select the *Timer* sensor button or the set alarm time on the display.

The audible signal will stop and the symbols on the display will go out.

## Changing an alarm

- Select the alarm on the display or select the *Timer* sensor button and the alarm you want.

The set alarm time will appear on the display.

- Set the new time for the alarm.
- Tap *Close* to confirm.

The adjusted alarm time is now saved and will appear on the display.

## Deleting an alarm

- Select the alarm on the display or select the *Timer* sensor button and the alarm you want.

The set alarm time will appear on the display.

- Select *Delete*.
- Tap *Close* to confirm.

The alarm is deleted.

## Using the Timer function

The ⏰ timer can be used to time other activities in the kitchen, e.g., boiling eggs.

The timer can also be used at the same time as a cooking program for which the start and finish times have been set (e.g., as a reminder to stir the food or add seasoning, etc.).

- The maximum timer duration that can be set is 59 minutes and 59 seconds.

**Tip:** When using an operating mode with moisture injection, use the timer to remind you to inject steam manually at the required time.

## Setting the timer

If you have selected the Display | QuickTouch | Off setting, you will need to turn the oven on before setting the timer. The timer can then be seen counting down on the display when the oven is turned off.

Example: you want to boil some eggs and set a timer of 6 minutes and 20 seconds.

- Select the *Timer* sensor button.
- Select ⏰ Timer.
- Set the required timer duration.
- Tap *Close* to confirm.

When the oven is turned off, the timer duration counts down on the display and ⏰ appears instead of the time of day.

If you are cooking at the same time or if you are in a different menu, the timer duration and ⏰ will appear in the top right-hand corner of the display.

At the end of the timer duration, ⏰ will flash, the time will start counting up, and an audible signal will sound.

- Select the *Timer* sensor button or the required timer on the display.

The audible signal will stop and the symbols on the display will go out.

## Changing the timer

- Select the timer on the display or select the *Timer* sensor button and then the timer duration you want.

The set timer duration will appear.

- Set a new timer duration.
- Tap *Close* to confirm.

The changed timer duration is now saved and will count down in minutes. Timer durations of less than 10 minutes will count down in seconds.

## Deleting the timer

- Select the timer on the display or select the *Timer* sensor button and then the timer duration you want.

The set timer duration will appear.

- Select *Delete*.
- Tap *Close* to confirm.

The timer is deleted.







## Main and submenus

As different countries have different preferences when it comes to preparing food, the temperatures in °F and °C may not match. The temperatures are defined as they are specified in the table.

Menu	Recommended temp.	Range
Operating Modes		
Convection Bake	350°F (160°C)	85–475°F (30–250°C)
Convection Roast	375°F (170°C)	85–475°F (30–250°C)
Surround	400°F (180°C)	85–525°F (30–280°C)
Moisture Plus		
Moisture Plus + Auto Roast	350°F (160°C)	275–475°F (130–230°C)
Moisture Plus + Conv Bake/ Moisture Plus + Conv Roast	350°F (160°C)	275–475°F (130–250°C)
Moisture Plus + Intensive	350°F (170°C)	275–475°F (130–250°C)
Moisture Plus + Surround	350°F (180°C)	275–525°F (130–280°C)
Intensive	400°F (170°C)	125–475°F (50–250°C)
Auto Roast	375°F (160°C)	200–450°F (100–230°C)
Bake	375°F (190°C)	200–525°F (100–280°C)
Browning	350°F (190°C)	200–475°F (100–250°C)
Maxi Broil	500°F (240°C)	400–575°F (200–300°C)
Broil	500°F (240°C)	400–575°F (200–300°C)
Convection Broil	400°F (200°C)	200–500°F (100–260°C)



## Main and submenus





Menu	Recommended temp.	Range
Automatic Programs 		
Special Modes 		
Defrost	100°F (25°C)	75–125°F (25–50°C)
Dehydrate	150°F (60°C)	85–175°F (30–70°C)
Warm-up Cookware	175°F (80°C)	125–225°F (50–100°C)
Proof		
Proof for 15 minutes	–	–
Proof for 30 minutes	–	–
Proof for 45 minutes	–	–
Slow Roasting	225°F (100°C)	175–250°F (80–120°C)
Sabbath Program		
Surround	355°F (180°C)	85–525°F (30–280°C)
Bake	375°F (190°C)	85–525°F (30–280°C)
Keep warm	175°F (75°C)	125–200°F (60–90°C)
MyMiele 		
Favorites 		
Settings 		
Self clean 		

## Moisture Plus

---

Your oven is equipped with a steam injection system for cooking with moisture. When baking, roasting, and cooking with the Moisture Plus  operating mode, optimized steam supply and air flow guarantee even cooking and browning results.

You can also use moisture injection with various types of heating:

- Moisture Plus + Auto Roast 
- Moisture Plus + Conv Bake/Moisture Plus + Conv Roast 
- Moisture Plus + Intensive 
- Moisture Plus + Surround 

After selecting the operating mode you want, set the temperature and the number and type of bursts of steam (Automatic, Manual, or with Timer).

The water is injected as bursts of steam into the oven compartment during the cooking program. The steam openings are located in the rear left corner of the ceiling of the oven.

## Suitable food

One burst of steam takes about 5–8 minutes. The number of bursts of steam and when they are injected will depend on the type of food being cooked:

- **Yeast doughs** will rise better if steam is injected at the beginning of the program.
- **Bread and bread rolls** rise better if steam is released at the start. Another burst of steam at the end of the program will give the bread and rolls a glistening crust.
- When **roasting meat with a high fat content**, injecting steam at the beginning of roasting will help render the fat.

Moisture injection is not suitable for mixtures which already contain a lot of moisture, such as meringues. These need to dry out during the baking process.

## Starting a cooking program with Moisture Plus

It is normal for condensation to form on the inside of the door during steam injection. This will dissipate during the course of the cooking program.

- Prepare the food and place it in the oven.
- Select Operating Modes .
- Select Moisture Plus .
- Select the operating mode you want with moisture injection.  
The cooking programs proceed in the same way for all heating types.

The recommended temperature will appear.

### Setting the temperature

- Adjust the recommended temperature, if necessary.
- Select Continue.
- If necessary, turn on the Preheat function via the pull-down menu.

The selection display for releasing the bursts of steam will then appear.

## Selecting the bursts of steam

The oven automatically draws in water and triggers the bursts of steam at specific times. You will hear the pump briefly during this process.

- Select Automatic, Manual, or with Timer.
  - Automatic  
1 burst of steam will be injected into the oven automatically after the preheating phase.
  - Manual  
You can release 1, 2, or 3 bursts of steam manually using the touch display.
  - with Timer  
You can set the times for the bursts of steam to be released. The oven will inject 1, 2, or 3 bursts of steam at the set times.

If you are cooking food such as bread or bread rolls in a preheated oven, it is best to release the bursts of steam manually and turn on the Preheat function. The first burst of steam should be released as soon as you have placed the food in the oven.

If you select more than one burst of steam, the second burst of steam cannot be released before the temperature in the oven compartment has reached at least 265°F (130°C).

If you want to use the Preheat function, take the preheating phase into account for the manual and time-controlled bursts of steam (see “Operating the oven – Preheat”).

- Select the number of bursts of steam (for Manual and with Timer only).

# Moisture Plus

- Set the times for the bursts of steam as required.
- Select Continue.

The oven heating and cooling fan will turn on. The required and the actual temperature will appear.

You will see the temperature rising on the display. An audible signal will sound when the set temperature is reached for the first time.

If you have selected with Timer, you can check the time before steam is released by selecting **i** Info.

## Injecting bursts of steam

 Risk of injury caused by steam. Steam can cause severe scalding. In addition, steam condensing on the control panel will cause the sensor buttons and the touch display to react more slowly. Do not open the door while bursts of steam are being released.

### Automatic

Once the preheating phase is complete, the burst of steam is injected automatically.

The water will evaporate in the oven compartment and Burst of steam will appear on the display.

After the steam has been released, Burst of steam will disappear.

- Continue cooking until the end of the cooking duration.

### Manual

You can release the bursts of steam as soon as Burst of steam appears and Start is shown in green.

Please wait until the preheating phase is completed to allow the steam to be distributed evenly by the warm air in the oven.

**Tip:** Use the Timer  function as a reminder.

- Select Start.

The burst of steam will be released. Start is deactivated.

- Proceed as described to release further bursts of steam once Start is shown in green.

After the final burst of steam, Start is deactivated.

- Continue cooking until the end of the cooking duration.

### with Timer

The oven will release the bursts of steam automatically at the specified times.

Burst of steam appears when the burst of steam is being released.

After the final burst of steam, Burst of steam will disappear.

- Continue cooking until the end of the cooking duration.

With the wide range of automatic programs, you can achieve excellent results with ease.

## Categories

The automatic programs  are sorted into categories to provide a better overview. Simply select the appropriate automatic program for the type of food you are cooking and follow the instructions on the display.

## Using automatic programs

- Select Automatic Programs .

A list will appear.

- Select the food category you want.

The automatic programs available for the category selected will then appear.

- Select the automatic program that you want to use.
- Follow the instructions on the display.

Some automatic programs will prompt you to use the probe. Read the information under “Roasting – Probe”.

Core temperatures cannot be changed for automatic programs.

**Tip:** Use  Info to display information such as how to place or turn the food depending on the cooking program.

## Usage notes

- After cooking, allow the oven compartment to cool down to room temperature again before starting a automatic program.
- Some automatic programs require a preheating phase before food can be placed in the oven. A prompt will appear on the display indicating when this needs to be done.
- Some automatic programs require liquid to be added during the cooking process. You will be prompted by a message on the display when this needs to be done (e.g., for adding liquid).
- The duration quoted for automatic programs is an estimate. It may increase or decrease depending on the program. The duration, in particular with meat, will vary depending on the initial temperature of the food.
- When you use the probe, the cooking duration will depend on when the core temperature is reached.
- If by the end of a automatic program the food is not cooked enough for your taste, select *Continue cooking* or *Continue baking*. Conventional heating will then be used for 3 minutes to continue cooking or baking the food.

# Automatic Programs

---

## Search

(Depending on language)

Under Automatic Programs, you can search by the name of the categories and the automatic programs.

This search is a full-text search and can also be used to search for parts of words.

From the main menu:

- Select Automatic Programs .

The category list will appear on the display.

- Select Search.
- Use the keyboard to type in the search text, e.g., "Bread".

The number of hits will be shown in the footer.

If no match is found or if there are more than 40 matches, the hits field will be deactivated and you will need to change the search text.

- Select XX hits.

The categories and automatic programs found will then appear.

- Select the automatic program you want, or the category and then the automatic program you want.

The automatic program will start.

- Follow the instructions on the display.

This section provides information on the following applications:

- Defrost
- Dehydrate
- Warm-up Cookware
- Proof
- Slow Roasting
- Sabbath Program
- Keep warm
- Canning
- Frozen food/ready meals

## Defrost

Gentle defrosting of frozen goods means that the vitamins and minerals are generally retained.

- Select Special Modes .
- Select Defrost.
- If necessary, adjust the recommended temperature and set the duration.

Air is circulated throughout the oven compartment to gently defrost the food.

Always observe USDA/CFIA food safety guidelines.

 Risk of infection from bacteria. Bacteria such as salmonella can cause life-threatening food poisoning.

It is particularly important to observe food hygiene rules when defrosting fish and meat, and in particular when defrosting poultry.

Do not use the liquid produced during defrosting.



Process the food as required as soon as it has been defrosted.

## Tips

- Remove the packaging and place the frozen food on the universal tray or in a suitable bowl or dish.
- Use the universal tray with the wire rack placed on top of it for defrosting poultry. This way the food will not be lying in the defrosted liquid.
- Fish does not need to be fully defrosted before cooking. Defrost until the food has started to thaw. The surface will then be sufficiently thawed to take herbs and seasoning.

## Defrosting durations

The duration needed for defrosting depends on the type and weight of the frozen food:

Frozen food	 [oz/g]	 [min]
Chicken	28/800	90–120
Meat	17.5/500	60–90
	35/1000	90–120
Sausage	17.5/500	30–50
Fish	35/1000	60–90
Strawberries	10.5/300	30–40
Pound cake	17.5/500	20–30
Bread	17.5/500	30–50

 Weight/ defrosting duration

## Special Modes

### Dehydrate

Dehydrating or drying is a traditional method of preserving fruit, certain vegetables, and herbs.





It is important to check that fruit and vegetables are fresh, ripe and unbruised before they are dehydrated.





- Prepare the food for drying by cutting it up, and peeling and coring it if necessary.
- Depending on how big it is, distribute the food for drying as evenly as possible over the rack or universal tray in a single layer.

**Tip:** You can also use the perforated Gourmet Baking Tray, if you have one.

- Dry on a maximum of 2 levels at the same time.  
Place the food for drying on shelf levels 1+3.  
If using the rack and universal tray, place the universal tray below the rack.
- Select Special Modes .
- Select Dehydrate.
- Alter the recommended temperature if necessary and then set the time.
- Follow the instructions on the display.
- Turn the food being dried on the universal tray at regular intervals.

The drying times are longer for whole or halved food.

Food for drying		°F [°C]	⌚ [h]
Fruit		140-160 (60-70)	2-8
Vegetables		130-150 (55-65)	4-12
Mushrooms		115-125 (45-50)	5-10
Herbs*		85-95 (30-35)	4-8

-  special mode/operating mode,
-  temperature,  drying time,
-  special mode Dehydrate,
-  operating mode Surround

\* When drying herbs, always use the universal tray on shelf level 2 and use the Surround  operating mode, as the fan is switched on in the Dehydrate special mode.

- Reduce the temperature if condensation begins to form in the oven.

### Removing the dried food

 Risk of injury caused by hot surfaces.

The oven gets hot during operation. You could burn yourself on the heating elements, oven compartment, or accessories. Use pot holders when removing the food from the oven.

- Allow the fruit or vegetables to cool down after dehydrating.

Dried fruit must be completely dry, but also soft and elastic. Juice should not escape when cut.

- Store dried food in sealed glass jars or cans.



## Warm-up Cookware

By preheating the dishware, the food does not cool down as quickly.

Use heat-resistant dishware.

- Place the wire rack on shelf level 3 and place the dishware to be heated on it. Depending on the size of the dishware, you can also place the rack on the oven floor and take the side runners out to make more room.
- Select Special Modes .
- Select Warm-up Cookware.
- Alter the recommended temperature if necessary and then set the time.
- Follow the instructions on the display.

 Risk of injury caused by hot surfaces.

The oven gets hot during operation. You could burn yourself on the heating elements, oven compartment, or accessories. Condensation may accumulate on the bottom of the dishware. Use oven mitts when removing dishware.

## Proof

This mode is designed specifically for proofing dough.

- Select Special Modes .
- Select Proof.
- Select the proving time.
- Follow the instructions on the display.

## Keep warm

You can keep food warm in the oven for several hours.

In order to maintain the quality of food, select the shortest possible time.

- Select Special Modes .
- Select Keep warm.
- Place the food to be kept warm in the oven and confirm with *OK*.
- Alter the recommended temperature if necessary and then set the time.
- Follow the instructions on the display.

# Special Modes

---

## Slow Roasting

The Slow Roasting method is ideal for cooking beef, pork, veal, or lamb when you want a tender result.

Always observe USDA/CFIA food safety guidelines.

First briefly sear the meat on all sides at a high temperature on the cooktop in order to seal it.

Then place the meat in the preheated oven where the low temperature and long cooking duration will cook it to perfection and ensure it is very tender.

The meat will relax. The juices inside will start to circulate evenly throughout the meat to reach the outer layers.

This gives very tender and succulent results.

- Only use lean meat which has been correctly seasoned and trimmed. Bones should be removed before cooking.
- For searing, use a suitable cooking oil or fat that can withstand high temperatures (e.g., clarified butter, vegetable oil).
- Do not cover meat during the cooking process.

Cooking takes approx. 2–4 hours depending on the weight and size of the meat and how well you want it cooked.

- As soon as the cooking program has finished, you can carve the meat straight from the oven. It does not need to rest.
- You can leave the meat in the oven to keep warm until you serve it. This will not affect results in any way.
- Serve on preheated plates with very hot sauce or gravy to prevent it cooling down too quickly. The meat is at an ideal temperature to eat straight away.

**Tip:** Using the pull-down menu, turn on the *Keep warm* function to keep the food warm without inadvertently cooking it further.

## Using the Slow Roasting Special Mode

Observe the information under “Roasting – Precision Probe”.

- Select Special Modes .
- Select Slow Roasting.
- Follow the instructions on the display. Place the necessary accessories in the oven compartment for the preheating phase.
- Set the temperature and the core temperature.
- While the oven is preheating, sear the meat on all sides on the cooktop.

 Danger of burning due to hot surfaces.



The oven gets hot during operation. You could burn yourself on the heating elements, oven compartment, or accessories. When the oven is hot, use pot holders to insert, remove, or turn food, as well as when adjusting the oven shelves, etc.

- **Once** Insert the probe and place food in the oven **appears on the display**, place the seared meat on the wire rack and insert the probe so that the metal tip is fully in the center of the meat.
- Close the door.

At the end of the program, Ready will appear on the display and an audible signal will sound.

## Using the Surround operating mode

Use the universal tray with the wire rack placed on top of it. Turn off the **Booster** function for the preheating phase.

- Place the wire rack with the universal tray on shelf level 3.
- Select Operating Modes .
- Select the Surround  operating mode and a temperature of 250°F (120°C).
- Turn off the **Booster** function via the pull-down menu.
- Preheat the oven together with the universal tray and wire rack for approx. 15 minutes.
- While the oven is preheating, sear the meat on all sides on the cooktop.

 Danger of burning due to hot surfaces.

The oven gets hot during operation. You could burn yourself on the heating elements, oven compartment, or accessories. When the oven is hot, use pot holders to insert, remove, or turn food, as well as when adjusting the oven shelves, etc.

- Place the seared meat on the wire rack.
- Reduce the temperature to 210°F (100°C).
- Continue cooking until the end of the cooking duration.

# Special Modes

## Cooking durations/core temperatures

Always observe USDA/CFIA food safety guidelines.

Meat	Cooking duration	Core temperature
Beef tenderloin, approx. 2.2 lbs (1 kg) - rare - medium - well done	60–80 min 75–85 min 110–130 min	113–119°F (45–48°C) 129–135°F (54–57°C) 145–151°F (63–66°C)
Prime rib, approx. 2.2 lbs (1 kg) - rare - medium - well done	70–80 min 105–115 min 130–140 min	113–119°F (45–48°C) 129–135°F (54–57°C) 145–151°F (63–66°C)
Pork tenderloin, approx. 0.75 lbs (350 g)	70–90 min	145–156°F (63–69°C)
Gammon joint*, approx. 2.2 lbs (1 kg)	140–160 min	145–151°F (63–66°C)
Veal tenderloin, approx. 2.2 lbs (1 kg) - pink - medium - well done	45–55 min 75–85 min 90–100 min	113–119°F (45–48°C) 129–135°F (54–57°C) 145–151°F (63–66°C)
Saddle of veal*, approx. 2.2 lbs (1 kg) - pink - medium - well done	75–85 min 100–130 min 130–140 min	113–119°F (45–48°C) 129–135°F (54–57°C) 145–151°F (63–66°C)
Saddle of lamb*	40–60 min	129–151°F (54–66°C)

\* Boneless

## Sabbath Program

The Sabbath Program and Yom-Tov Special Modes help to support religious observance.

The oven heats up to the temperature you have set and maintains this temperature for a maximum of 24 hours (Sabbath Program) or 76 hours (Yom-Tov).

- Select Special Modes .
- Select Sabbath Program.
- Select the Special Mode you want.
- Select the operating mode you want to use.

You will not be able to start the Special Mode if you have set a timer or alarm.

- Set the temperature.
- Select Start.

The name of the Special Mode and the set temperature will appear on the display.

The oven heating will turn on around 30 seconds after you have closed the door.

The oven interior lighting will remain on during the entire cooking period.

Sabbath Program or Yom-Tov and the set temperature will appear permanently on the display.

The time of day will not appear. The proximity sensor will not respond, and neither will any of the sensor buttons (except for the  On/Off button).

The message Do not open the door will appear.

After around 1 hour, this information will turn off from time to time. You can open the door when this message is **not** shown.

- Place the food in the oven.

The Sabbath Program Special Mode ends after 24 hours. The display will not change.

In both Special Modes, the oven turns off automatically after 76 hours.

- If you want to end the Special Mode prematurely, turn off the oven using the  On/Off button.

Once a Special Mode has started, it cannot be changed or saved under Favorites.

# Special Modes

## Canning

 Risk of infection from bacteria.

The spores of the botulinum bacterium are not sufficiently killed by canning legumes and meat only once. Toxins may form which can lead to serious poisoning. These spores are only destroyed by canning the food again.

After they have cooled down, **always** reheat legumes and meat a second time within 2 days.

 Risk of injury from increased pressure in sealed cans.

Canning food and heating it up in closed containers results in an increase in pressure which can cause them to explode.

Do not use cans for canning or reheating food.

Always observe USDA/CFIA food safety guidelines.

## Preparing fruit and vegetables

The instructions are for 6 jars with a capacity of 1 liter each.

Only use special jars for canning (preserving jars or jars with a screw cap). Only use undamaged jars and rubber rings.

- Rinse the jars with hot water before canning and fill them up to a maximum of 3/4" (2 cm) below the rim.
- Slide the universal tray onto shelf level 3. Place the jars on the tray.
- Select the Convection Bake  operating mode and a temperature of 325-350°F (160-170°C).
- Wait until bubbles rise evenly in the jars.



Then reduce the temperature to prevent the contents from boiling over.

## Canning fruit and vegetables

- Set the specified post-canning warming temperature as soon as bubbles are visible in the jars, then leave the jars in the warm oven for the time specified.

## Canning vegetables

- As soon as bubbles are visible in the jars, set the specified preserving temperature and cook the vegetables for the time specified.
- After canning, set the specified post-canning warming temperature, then leave the jars in the warm oven for the time specified.

		
Fruit	-/-	85°F (30°C)/ 25–35 min
Pickling cucumbers	-/-	85°F (30°C)/ 25–30 min
Beets	250°F (120°C)/ 30–40 min	85°F (30°C)/ 25–30 min
Beans (green or yellow)	250°F (120°C)/ 90–120 min	85°F (30°C)/ 25–30 min

 Canning temperature and time once bubbles are visible in the jars

 Post-canning warming temperature and time

## Removing the jars after canning

 Risk of injury caused by hot surfaces.

The jars will be very hot after canning.

Use oven mitts when removing the jars from the oven.

- Take the jars out of the oven.
- Cover the jars with a towel and leave to set for approx. 24 hours in a draft-free area.
- After they have cooled down, **always** reheat beans and meat a second time within 2 days.
- Remove the fasteners from the jars and make sure all jars are closed properly when storing them.

Either boil open jars again or store them in a cool place and consume the preserved fruit or vegetables immediately.

- Check the jars during storage. If jars have opened during storage or if the screw cap is bulging and does not make a popping noise when opened, dispose of the contents.

# Special Modes

---

## Frozen food/ready meals

### Tips for cakes, pizza, and baguettes

- Bake cakes, pizza, and baguettes on parchment paper on the wire rack.
- Use the lowest temperature recommended by the manufacturer.

### Tips for French fries, croquettes, and similar items

- Cook frozen food items on parchment paper placed on a baking tray or the universal tray.
- Use the lowest temperature recommended by the manufacturer.
- Turn several times during cooking.

## Preparing frozen food/ready meals

Handling and cooking food correctly is essential for maintaining good health.

Cakes, pizzas, and French fries should be cooked until golden, not dark brown.

- Select the operating mode and temperatures recommended on the food's packaging.
- Preheat the oven.
- Place the food in the preheated oven on the shelf level recommended on the packaging.
- Check the food at the end of the shortest time recommended on the packaging.



Under MyMiele , you can save frequently used applications.

It is particularly useful with the automatic programs as you do not need to work through every screen in order to start a program.





**Tip:** You can also set menu options that you have entered in MyMiele to appear on the start screen (see “Settings – Start screen”).

## Adding entries

You can add up to 20 entries.

- Select MyMiele .
- Select Add entry.

You can select options from the following categories:

- Operating modes 
- Automatic Programs 
- Special Modes 
- Favorites 
- Maintenance 

- Confirm with OK.

The selected subitem and its respective symbol will appear in the list.

- Proceed as described for further entries. Only options that have not yet been selected are available for selection.

## Deleting entries

- Select MyMiele .
- Touch the entry you want to delete and keep your finger on it until the context menu appears.
- Select Delete.

The entry will then be removed from the list.

## Moving entries

- Select MyMiele .
- Touch the entry you want to move and keep your finger on it until the context menu appears.
- Select Move.

An orange border will appear around the entry.

- Move the entry.

The entry will now appear in the position you want it in.

## Favorites

---

You can create and save up to 20 of your own programs.

- You can combine up to 10 cooking stages to accurately program your favorite or most frequently used recipes. In each cooking stage, you can select settings such as the operating mode, temperature, and cooking duration or core temperature.
- You can specify the shelf level(s) for the food.
- You can enter a program name for your recipe.

When you next select the program, it will start automatically.

There are different ways of creating a Favorite:

- When a automatic program finishes running, save it as a separate program.
- After running a program with a set duration, save it.

Then name the program.

### Creating a Favorite

- Select Favorites .
- Select Create program.

You can now specify the settings for the first cooking stage.

Follow the instructions on the display:

- Select and confirm the settings.

If you select the *Preheat* function, use *Add* to add another cooking stage where you set a cooking duration. Only then can you save or start the program.

All settings for the first cooking stage have now been set.

More cooking stages can be added, for example, if you would like to add another operating mode to follow the first.

- If additional cooking stages are required, select *Add* and proceed as for the first cooking stage.
- When you have finished setting the cooking stages, select *Set shelf level*.
- Select the level(s) you want.
- Confirm with *OK*.

If you want to check the settings or to change them at a later stage, tap the cooking stage in question.

- Select *Save*.
- Enter the program name using the keyboard.

You can add a line break for longer program names using the  symbol.

- Once you have entered the program name, select *Save*.

A message will appear on the display confirming that the name has been saved.

- Confirm with *OK*.

You can start the saved program immediately, delay the start, or change the cooking stages.

## Starting Favorites

- Place the food in the oven cavity.
- Select Favorites .
- Select the program you want to use.

Depending on the program settings, the following menu options will appear on the display:

- Start now  
The program will start immediately.  
The oven heating will turn on immediately.
  - Ready at  
You can set the time at which the cooking program should end. The oven will turn off automatically at the time you have set.
  - Start at  
You can set the time at which the cooking program should start. The oven will turn on automatically at the time you have set.
  - Display cooking stages  
A summary of your settings will appear on the display.
  - Display actions  
The required actions, e.g., placing the food in the oven, will appear on the display.
- Select the menu option you want.
  - Confirm the message regarding which shelf level to use with *OK*.

The selected program will begin automatically right away or at the time set.

Use  Info to display information such as how to place or turn the food depending on the cooking process.

- At the end of the program, select *Close*.

## Changing cooking stages

Cooking stages in an automatic program that have been saved under a different name cannot be changed.

- Select Favorites .
- Touch the program you want to change and keep your finger on it until the context menu appears.
- Select *Change*.
- Select the cooking stage that you want to change or *Add* to add another cooking stage.
- Select and confirm the settings.
- If you want to start the modified program without changing it, select *Start*.
- Select *Save* when you have changed all the settings.

A message will appear on the display confirming that the name has been saved.

- Confirm with *OK*.

The saved program has been changed and you can start it immediately or delay the start.

# Favorites

---

## Renaming Favorites

- Select Favorites .
- Touch the program you want to change and keep your finger on it until the context menu appears.
- Select Rename.
- Change the program name using the keyboard.

You can add a line break for longer program names using the ↵ symbol.

- Once you have changed the program name, select *Save*.

A message will appear on the display confirming that the name has been saved.

- Confirm with *OK*.

The program has now been renamed.

## Deleting a Favorite

- Select Favorites .
- Touch the program you want to delete and keep your finger on it until the context menu appears.
- Select Delete.
- Confirm the query with *Yes*.

The program is deleted.

Go to Settings | Factory default | Favorites to delete all Favorites at the same time.

## Moving Favorites

- Select Favorites .
  - Touch the program you want to move and keep your finger on it until the context menu appears.
  - Select Move.
- An orange border will appear around the entry.
- Move the program.

The program will now appear in the position you want it in.

Handling and cooking food correctly is essential for maintaining good health.

Cakes, pizzas, and French fries should be cooked until golden, not dark brown.

Always observe USDA/CFIA food safety guidelines.

## Tips for baking

- Set a cooking duration. If used for baking, do not delay the start for too long. Otherwise the cake mixture or dough will dry out, and the raising agents will lose their effectiveness.
- Generally speaking, you can use wire racks, baking trays, universal trays, and any type of bakeware made of heat-resistant material.
- Avoid using bright, thin-walled pans made from a shiny material as they give an uneven or poor browning result. In certain unfavorable conditions, the food will not cook properly.
- Place cakes in rectangular bakeware on the wire rack with the longer side across the width of the oven for optimum heat distribution and even results.
- Always place bakeware on the wire rack.
- When baking cakes with fruit toppings or deep cakes, place the pan on the universal tray to catch any spillages.

## Using parchment paper

Miele accessories, e.g., the universal tray, are treated with PerfectClean (see “Features”). Surfaces treated with PerfectClean generally do not need to be greased or covered with parchment paper.

- Use parchment paper when baking lye mixtures (e.g., pretzels) because the sodium hydroxide can damage the PerfectClean treated surface.
- Use parchment paper when baking sponge cake, meringue, macaroons, or similar items. These are more likely to stick due to their high egg white content.
- Use parchment paper when cooking frozen food on the wire rack.

## Selecting the temperature

- Select the suggested temperature in general.

Choosing a baking temperature higher than those recommended may reduce the cooking time, but will lead to uneven browning and unsatisfactory cooking results.

## Selecting the cooking duration

- Check whether the food is cooked shortly before the end of the specified cooking duration. Stick a wooden skewer into the food.

If it comes out clean without any batter/dough on it, the food is done.

# Baking

---

## Notes on the operating modes

You can find an overview of all the operating modes with their recommended values in “Main and submenus”.

### Using Automatic Programs

- Follow the instructions on the display.

### Using Convection Bake

Because the blower distributes the heat around the oven compartment straight away, you can use a lower temperature than you would with the Surround  operating mode.

Use this operating mode if you are baking on multiple shelf levels at the same time.

- 1 shelf: Place the food on shelf level 2.
- 2 shelves: Place the food on shelf levels 1+3 or 2+4.
- 3 shelves: Place the food on shelf levels 1+3+5.

### Tips

- If you are cooking on multiple shelf levels at the same time, slide the universal tray in on the lowest level.
- For moist cookies and cakes, bake on a maximum of 2 shelf levels at once.

### Using Moisture Plus

Use this operating mode with your preferred type of heating for cooking with moisture injection.

- Place the food on shelf level 2.

### Using Intensive

Use this operating mode for baking cakes with moist toppings.

Do **not** use this operating mode for baking thin biscuits.

- Place cakes on shelf level 1 or 2.

### Using Surround

Dark metal, enamel, or aluminum bakeware with a matte finish, as well as heat-resistant glass, ceramic, and coated bakeware can be used.

Use this operating mode for cooking traditional recipes. If using an older recipe or cookbook, set the oven temperature 25°F (10°C) lower than that recommended. This will not change the cooking duration.





- Place the food on shelf level 1 or 2.

Always observe USDA/CFIA food safety guidelines.

## Tips for roasting

- You can use all dishware made from temperature-resistant materials, e.g., roasting dishes, roasting pans with lid, ovenproof glass dishes, roasting bags, dishes made from earthenware or cast iron, the universal tray, wire rack, and/or anti-splash insert (if available) on top of the universal tray.
- **Preheating** the oven is only required when preparing roast beef and fillets. Preheating is generally not necessary.
- Use a **closed cooking container** for roasting meat, such as a roasting dish. The meat will stay succulent. The oven compartment will also stay cleaner than when roasting on the wire rack. It ensures that enough stock remains for making gravy.
- If you are using a **roasting bag**, follow the instructions on the packaging.
- If you are using the **wire rack** or an **open cooking container** for roasting, you can add a little fat or oil to very lean meat or place a few strips of bacon on the top.
- **Season** the meat and place in the cooking container. Dot with butter or brush with oil or cooking fat. For large lean cuts of meat (4–6 lb/2–3 kg) and fatty poultry, add about 1/2 cup (1/8 liter) of water to the dish.
- Do not add too much liquid during cooking as this will hinder the **browning** process. Browning only occurs towards the end of the cooking duration. Remove the lid about halfway through the cooking duration if you want a more intensive browning result.
- At the end of the program, take the food out of the oven, cover it, and leave to **stand** for about 10 minutes. This helps retain the juices when the meat is sliced.
- For a crisp finish, baste **poultry** 10 minutes before the end of the cooking duration with slightly salted water.

## Selecting the temperature

- As a general rule, select the temperature given in the corresponding recipe.
- For large pieces of meat, do not choose a temperature that is too high. The roasting process will take longer, but the meat will cook through evenly and the skin or crackling will not be too thick.
- When cooking with Convection Roast , Moisture Plus  or Auto Roast , select a temperature which is approx. 50°F (20°C) lower than with Surround .
- When roasting on the wire rack, set a temperature approx. 25°F (10°C) lower than for roasting in a covered cooking container.

# Roasting

## Selecting the cooking duration

- Check whether the food is cooked shortly before the end of the specified cooking duration.

### Tips

- For frozen meat, increase the cooking duration by approx. 10 minutes per lb (20 minutes per kg).
- Frozen meat weighing less than approx. 3.3 lb (1.5 kg) does not need to be defrosted before roasting.

## Notes on the operating modes

You can find an overview of all the operating modes with their recommended values in “Main and submenus”.

Use the Bake  operating mode towards the end of the cooking duration to brown the base of the food.



Do not use the Intensive  operating mode for roasting as the juices will become too dark.

## Using Automatic Programs

- Follow the instructions on the display.

## Using Convection Roast or Auto Roast

These operating modes are suitable for roasting meat, fish, and poultry that needs to be well browned, as well as sirloin and fillet.

The Convection Roast  operating mode allows you to use a lower temperature than you would with the Surround  operating mode, because the heat is immediately distributed throughout the oven compartment.

With the Auto Roast  operating mode, the oven compartment heats initially the highest temperature in this operating mode for searing. As soon as this temperature has been reached, the oven automatically drops the temperature back down to the preselected cooking temperature (continued roasting temperature).

- Place the food on shelf level 3.

## Using Moisture Plus

Use this operating mode with your preferred type of heating for cooking with moisture injection.

- Place the food on shelf level 2.

## Using Surround

Use this operating mode for cooking traditional recipes. If using an older recipe or cookbook, set the oven temperature 50 °F (10 °C) lower than that recommended. This will not change the cooking duration.

- Place the food on shelf level 2.



## Probe

Risk of injury. The metal tip of the probe can cause injury.

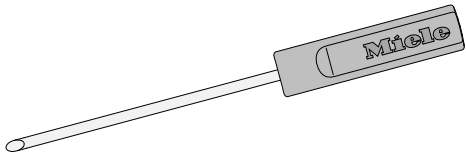

The wireless probe enables the roasting process to be monitored simply and reliably. The wireless probe can be cleaned in the dishwasher.

### How it works

The metal tip of the probe must be fully inserted into the center of the food. It contains four temperature sensors. The sensors measure the core temperature inside the food during the cooking process.

They are designed to monitor the rise in temperature in the coldest part of the food. The coldest part is usually in the center (core) of the food. The four temperature sensors are arranged in the metal tip so that the measured values they provide can be used to calculate the temperature in the coldest part of the food. This is still possible even if the metal tip is not located exactly in the core of the food.

The rise in the core temperature reflects the extent to which the food is cooked. You can program the core temperature to be lower or higher, depending on whether you want your meat to be rare, medium, or well done.

The core temperature can be set up to 210°F (99°C). Information on food and respective core temperatures can be found in “Special Modes – Slow Roasting”.

The cooking duration will be similar for cooking processes with or without the probe.

The core temperature value is sent via radio signal from the transmitter in the handle of the wireless probe via the antenna in the top right of the oven to the electronic of the appliance as soon as the food is put in the oven with the probe inserted.

Efficient radio transmission is only guaranteed if the oven door is closed. If the door is opened during a cooking process, e.g., to baste the food, radio signal transmission is interrupted. It will only resume when the door is closed. It will take a few seconds before the current core temperature appears again in the display.









If you do not intend to use the wireless probe, do not leave it in the oven while cooking. Always put it in the storage sleeve.

# Roasting

## When to use the probe

Some automatic programs and Special Modes will prompt you to use the probe.

You can also use the probe with Favorites and with the following operating modes:

- Auto Roast 
- Convection Roast 
- Intensive 
- Surround 
- Moisture Plus + Auto Roast 
- Moisture Plus + Conv Bake/  
Moisture Plus + Conv Roast 
- Moisture Plus + Intensive 
- Moisture Plus + Surround 

## Important usage notes

To ensure the probe works correctly, please observe the following instructions.

- Do not use deep, narrow, metal cooking containers, as these will weaken the radio signal.
- Do not place any metal objects such as lids or aluminum foil above the wireless probe. Do not use the wire rack or universal tray on a shelf level above the food containing the probe. Glass lids may be used.
- Do not use another standard metal cooking thermometer when using the wireless probe.
- Do not allow the handle of the wireless probe to sit in any sauce or cooking liquid, or to rest on the food or the edge of the cooking container.

 Risk of breakage!

Do not use the wireless probe to lift or carry the food.

In addition please note:

- The meat can be placed in a pot or on the universal tray and wire rack.
- The metal tip of the probe must be inserted into the center of the food so that the temperature sensors reach the core. The handle should be angled upward. **Make sure that the handle is not horizontal, facing the door, or the corners of the oven interior.**



- When cooking poultry, insert the metal part into the thickest part of the breast. You can find the thickest part of the breast by pressing the area with your thumb and index finger.
- The metal tip must not touch any bone or be inserted in areas with a lot of fat. Fatty tissue and bones can cause the probe to turn off early.
- When using roasting bags or aluminum foil, insert the probe through the bag or foil into the center of the food. You can also place meat inside the bag or foil with the probe already inserted. Be sure to follow the instructions provided by the manufacturer of the roasting bag or aluminum foil.

- The wireless probe can only be inserted horizontally into flat foods such as fish.

If the wireless probe is no longer recognized during cooking, a message will appear in the display. Reposition the probe in the food.

In some cases, reception interference can even be caused by a microwave operating in the vicinity of the oven, because the microwave uses a similar frequency range to that of the wireless probe. Turn off the microwave when you are using the wireless probe.

## Using the probe

Risk of injury. The metal tip of the probe can cause injury.

- Remove the wireless probe from the storage sleeve.
- Insert the metal tip of the probe into the food. The handle should be pointing up diagonally.
- Place the food in the oven.
- Close the door.
- Select an operating mode or automatic program.
- Set the temperature and the core temperature if necessary.

Core temperatures cannot be changed for automatic programs.

Follow the instructions on the display.

The cooking program finishes as soon as the core temperature is reached.

 Danger of injury caused by hot surfaces.

The handle of the probe can get hot. You can burn yourself on the handle. Wear pot holders when removing the probe from its socket.

**Tip:** If the food is not cooked sufficiently when the core temperature is reached, insert the probe into another place or increase the core temperature and repeat the program.

## Time-left display

If the temperature set for a cooking process is above 285°F (140°C), the estimated duration remaining (time left) will appear on the display.

The time left is calculated from the cooking temperature selected, the set core temperature, and the progress of the core temperature as it rises.

The time left first shown is an estimate. As the cooking process continues, the time left is revised continuously, and a more accurate figure is shown.

The time left will be deleted if the cooking temperature or core temperature is changed or if a different operating mode is selected. If the door is opened for a longer time, the time left will be recalculated.

# Broiling

 Risk of injury caused by hot surfaces.

If you broil with the door open, the hot air will escape from the oven before it has been cooled by the cooling fan. The control elements will get hot.

Broil with the oven door closed.

Always observe USDA/CFIA food safety guidelines.

## Tips for broiling

- Preheating is necessary when broiling. Preheat the browning/broiling element for approx. 5 minutes with the door closed.
- Quickly rinse meat under cold running water and pat dry. Do not season the meat with salt before broiling, as this will draw out the juices.
- Add a little oil to lean meat if necessary. Do not use other types of fat as they can easily burn and cause smoke.
- Clean fish in the normal way. To enhance the flavor, season with a little salt. You can also drizzle the fish with lemon juice.
- Use the universal tray with the broiling and roasting insert (if present) on top and place the universal tray on the wire rack.

- The tray under the insert will collect the meat juices and stop them from burning so that they can be used for making gravy and sauces. Brush the wire rack or the broiling and roasting insert with oil and then place the food on top. Using the broiling and roasting insert can reduce the amount of smoke produced.

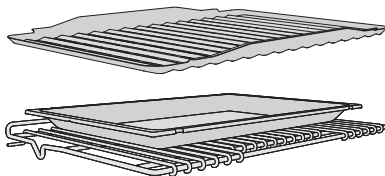

## Selecting the temperature

- As a general rule, select the temperature given in the corresponding recipe.
- For large pieces of meat, do not choose a temperature that is too high. The roasting process will take longer, but the meat will cook through evenly and the skin or crackling will not be too thick.

## Choosing a shelf level

- Select the shelf level depending on the thickness of the food to be cooked.
- Place flat food on shelf level 4 or 5.
- Place thicker food on shelf level 2 or 3.

## Selecting the cooking duration

- Broil thinner cuts of meat/slices of fish for approx. 6–8 minutes per side. It is best to broil food of a similar thickness at the same time so that the cooking durations do not vary too much.
- Check whether the food is cooked shortly before the end of the specified cooking duration.

**Tip:** If the surface of a thicker cut of meat is browned but the center is still raw, move the food to a lower level or reduce the temperature and continue broiling. This will stop the surface from becoming too dark.

## Notes on the operating modes

You can find an overview of all the operating modes with their recommended values in “Main and submenus”.

The plastic on the probe can melt at very high temperatures.

Do not use the probe when using the broiling operating modes.

Do not store the probe in the oven compartment when it is not being used.

## Using Maxi Broil

Use this operating mode to broil flat thin cuts in large quantities and for browning large baked dishes.

The entire browning/broiling element will become red hot to produce the necessary heat.

## Using Broil

Use this operating mode to broil flat thin cuts in smaller quantities and for browning small baked dishes.

Only the center of the browning/broiling element glows red to generate the required heat.

## Using Convection Broil

This operating mode is suitable for broiling thicker food, such as chicken.

We generally recommend a temperature setting of 425°F (220°C) for thinner types of food and 350–400°F (180–200°C) for thicker cuts.

# Gas cooktop cleaning and care

---

 Danger of injury caused by hot burners.

The burners will be hot after use.

Turn off the cooktop.

Allow the burners to cool down before cleaning the cooktop.

 Risk of injury due to electric shock.

The steam from a steam cleaning appliance could reach live electrical components and cause a short circuit.

Never use a steam cleaner for cleaning.

All surfaces could be discolored or damaged if unsuitable cleaning agents are used. All surfaces are susceptible to scratching.

Remove any residual cleaning agent immediately.

Do not clean with any abrasive or sharp pointed objects.

## Unsuitable cleaning agents

To avoid damaging the surfaces of your appliance, do not use:

- cleaning agents containing soda, alkali, ammonia, acids, or chlorides
- cleaning agents containing descaling agents
- stain or rust removers
- abrasive cleaning agents (e.g., powder cleaners and cream cleaners)
- solvent-based cleaning agents
- dishwasher cleaning agents
- grill and oven sprays
- glass cleaners
- hard, abrasive brushes or sponges (e.g., pot scourers, brushes, or sponges which have been previously used with abrasive cleaning agents)
- sharp objects
- eraser sponges

The surfaces of the burners and grates will become more matte in the course of time. This is quite normal and does not indicate damage to the material.

- Clean the cooktop after each use with a soft sponge, warm water and a small amount of liquid dish soap.
- Soften any stubborn soiling beforehand.
- Dry the cooktop after using water to clean it. This helps prevent lime deposits.

# Gas cooktop cleaning and care

**Tip:** Food which boils over on a hot cooktop can cause discoloration of the burner components. Remove any soiling and salt and sugar splashes immediately.

## Cleaning the grates

- Remove the grates.
- Clean the grates in a dishwasher or with a solution of warm water and a little liquid dish soap applied with a soft sponge.
- If necessary, the rough side of a kitchen sponge can be used.

## Control knobs in stainless steel color

Do not clean the control knobs in the dishwasher or with a stainless steel cleaning agent.

Clean the control knobs using a solution of warm water and a little liquid dish soap applied with a soft sponge.

The control knobs may become discolored if they are not cleaned regularly.

- Clean the control knobs using a solution of warm water and a little liquid dish soap applied with a soft sponge.

## Cleaning the normal/power burners

The burner cap is not dishwasher-safe.

Make sure that the flame holes are completely dry after cleaning.

- Remove the burner cap.
- Clean the burner cap using a soft sponge, warm water and a small amount of liquid dish soap.
- Clean all non-removable parts of the burner with a damp cloth.

## Ignitor

Do not let the ignitor get wet. If it gets wet, it will not spark.

- Clean the ignitor carefully with a well wrung-out cloth.

## Cleaning the grill

- Clean the grill after each use with hot water and a small amount of liquid dish soap.
- If the grill is very dirty, soak it first before removing the soiling with a brush.
- Then leave the grill to dry thoroughly.

# Gas cooktop cleaning and care

## Disassembling the grill

**⚠ Danger of burning!**  
Burners must be switched off. Make sure the cooktop has cooled down.

To make cleaning easier, you can dismantle the grill.

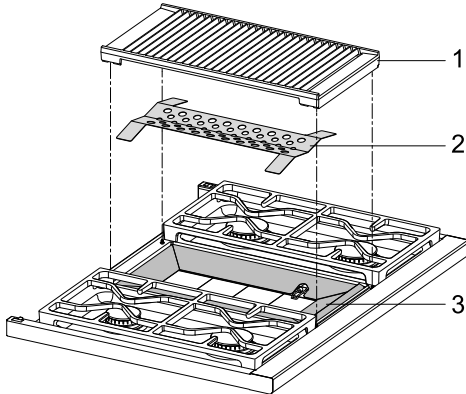

- ① Grill
- ② Protective panel
- ③ Frame

**⚠ Risk of injury!**  
The cast-iron grill is heavy. Carry the grill carefully and place it securely on a soft surface so that it lies flat.

- Remove the grill ① from the cooktop.
- Remove the protective panel ② and, if required, the frame ③.
- Clean the parts with warm water, liquid dish soap, and a soft sponge.
- Dry all parts with a soft cloth.

Reinstall by following these instructions in reverse order.

- Place the frame ③ on the surface burner. The recess for the igniter is located on the right side in the lower quarter of the frame.
- Place the protective panel ② on the frame ③.

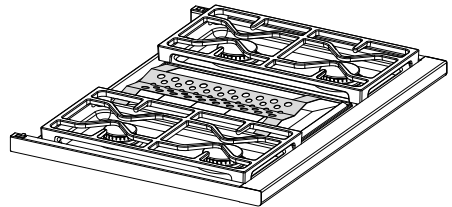

- Replace the grill ①.



## Cleaning the griddle plate



**Burn hazard!**

Allow the griddle plate to cool down sufficiently before cleaning it.



**Fire hazard!**

Clean the grease catch pan after every use of the griddle plate.

- Loosen coarse soiling immediately with a spatula and scratch grease and residue into the grease drip tray.
- Remove any excess grease with a paper towel.
- Once the griddle plate has cooled down, add some hot water and liquid dish soap and leave it to soak.
- Remove the soiling and water with a sponge.
- Remove the grease drip tray and empty it.
- Clean the grease drip tray with a soft sponge, warm water, and a small amount of liquid dish soap.
- Then dry the grease drip tray.
- Remove the soapy water and soiling from the griddle plate.
- Finally, clean the griddle plate with a damp cloth.
- Dry the griddle plate with a clean cloth.
- Rub a little vegetable oil onto the griddle plate after cleaning it.
- Replace the grease drip tray.

You can clean stubborn soiling off the griddle plate with the rough side of a dish sponge and a few drops of Miele Ceramic and Stainless Steel Cleaner (see “Features”).

# Cleaning and care of the oven

---

 Risk of injury caused by hot surfaces.

The oven gets hot during operation. You could burn yourself on the heating elements, oven compartment, or accessories. Allow the heating elements, oven compartment, and accessories to cool before manual cleaning.

 Risk of injury due to electric shock.

The steam from a steam cleaning appliance could reach live electrical components and cause a short circuit. Never use a steam cleaner for cleaning.

All surfaces could be discolored or damaged if unsuitable cleaning agents are used. The oven front is particularly susceptible to damage from oven cleaners or descaling agents.

All surfaces are susceptible to scratching. Scratches on glass can lead to breakage in some circumstances.

Remove all cleaning agent residues immediately.

## Unsuitable cleaning agents

To avoid damaging the surfaces of your appliance, do not use:

- Cleaning agents containing soda, ammonia, acids, or chlorides
- Cleaning agents containing descaling agents on the front

- Abrasive cleaning agents (e.g., powder cleaners and cream cleaners)
- Solvent-based cleaning agents
- Stainless steel cleaning agents
- Dishwasher cleaner
- Glass cleaners
- Cleaning agents for ceramic cooktops
- Hard, abrasive brushes or sponges (e.g., pot scourers, brushes, or sponges which have been previously used with abrasive cleaning agents)
- Eraser sponges
- Sharp metal scrapers
- Steel wool
- Spot cleaning with mechanical cleaning agents
- Oven cleaners
- Stainless-steel spiral pads

If soiling is allowed to sit for any length of time, it may become impossible to remove. If items are used frequently without being cleaned, it may become very difficult to clean them.

It is therefore best to remove any soiling immediately.

The accessories are not dishwasher-safe.

# Cleaning and care of the oven

**Tip:** Soiling caused by spilled fruit juices and cake mixtures is best removed while the oven is still warm. Use caution and make sure the oven is not too hot.

To make it easier to clean the oven:

- Remove the door.
- Remove the FlexiClips with Wire Rack.
- Remove the side racks.

## Removing normal soiling

There is a fiberglass seal around the oven compartment which seals the inside of the glass oven door and can be damaged by rubbing and scouring.

Avoid cleaning the fiberglass seal. The fiberglass seal is essential for sealing the door properly.

- Remove normal soiling immediately with warm water, liquid dish soap, and a clean sponge or a clean, damp microfiber cloth.
- Remove all cleaning agent residues thoroughly with clean water. This is particularly important for any parts with a PerfectClean finish, as cleaning agent residues will impair the non-stick function.
- After cleaning, wipe the surfaces dry using a soft cloth.

## Cleaning the probe

- Clean the food probe by hand or in the dishwasher.

## Removing stubborn soiling

Do not line the oven (e.g., with aluminum foil) and do not use standard oven cleaners unless they are suitable for use in a self-cleaning oven.

Spilt fruit and roasting juices may cause lasting discoloration or matte patches on surfaces. This discoloration will not affect the properties of the surface finish.

Do not attempt to remove these marks. Clean them following the instructions given here.

- Baked-on deposits can be removed with a glass scraper or with a stainless-steel spiral pad, hot water, and liquid dish soap.

You do not need to treat the oven compartment with an oven cleaner as the oven comes with  Self Clean.

- If necessary, you can use the scouring pad on the back of a non-scratching dish sponge to remove the soiling after the holding time.
- Remove all cleaning agent residues thoroughly with clean water.
- Dry all surfaces with a soft cloth.

# Cleaning and care of the oven

## Cleaning the oven compartment with Self clean

Instead of cleaning the oven compartment by hand, you can run the Self clean  function.

During the Self Clean function, the oven compartment reaches temperatures in excess of 750°F (400°C). Any grime that has accumulated will be broken down and burnt to ash as a result of the high temperatures.

There are 3 Self Clean settings available, each with a different duration:

- Level 1 for light soiling
- Level 2 for heavier soiling
- Level 3 for very heavy soiling

The oven door is automatically locked when the Self Clean process starts. It cannot be opened until after the program has finished.

The timer can be used to delay the start time of the Self Clean program.

At the end of the Self Clean program, any residues such as ash from the cleaning process, which are formed depending on the oven compartment's degree of soiling, can be easily wiped away.

## Preparing for Self Clean

Accessories that are not suitable for the Self Clean program will be damaged by the high temperatures.

Remove all accessories that are not suitable for the Self Clean program from the oven compartment before starting the Self Clean process. This also applies for optional accessories that are not suitable for the Self Clean program.

The following accessories are suitable for the Self Clean program and can be left in the oven compartment during the process:

- Side runners
- FlexiClips with Wire Rack HFCBBR 36-3
- Wire rack HBBR 36-2
- Remove all accessories that are not suitable for the Self Clean program from the oven.
- Slide the wire rack into the top shelf level.

Coarse soiling in the oven compartment can cause thick smoke to develop.

Burnt-on residues can cause lasting discoloration or dull spots on enameled surfaces.

Before starting the Self Clean program, remove coarse soiling from the oven compartment and scrape any burnt-on residues off enameled surfaces with a glass scraper.

## Starting Self Clean

 Danger of injury caused by hot surfaces.

The oven gets much hotter during the Self Clean program than during normal use.

Do not let children touch the oven during the Self Clean program.

- Select Self clean .
- Select the level required according to the amount of soiling.
- Confirm with *OK*.

Follow the instructions on the display.

- Confirm with *OK*.

You can start the Self Clean program straight away or schedule it to begin at a later time.

### Starting Self Clean straight away

- To start the Self Clean program straight away, select *Start now*.
- Confirm with *OK*.

The Self Clean program will start.

The door will lock automatically. The oven heating and the cooling fan will then turn on automatically.

The oven interior lighting will not come on during the Self Clean program.

The time left for the Self Clean program will start counting down on the display. You cannot alter the duration.

You can use the timer while the Self Clean program is running. When the set time has elapsed, the audible signal will sound and  will flash. The time will then continue to increase on the display. When you tap the *Timer* sensor button, the audible signal will stop and the symbols on the display will go out.

## Starting Self Clean at a later time

- To start the Self Clean program later, select *Start at*.
- Confirm with *OK*.
- Set the time at which you want the Self Clean program to start.
- Confirm with *OK*.

The door will lock automatically. Start at and the start time set will appear on the display.

You can reset the start time via *Timer* at any point up to the starting time.

Once the start time has been reached, the oven heating and cooling fan functions will be automatically activated. The remaining time will appear on the display.

### Finishing Self Clean

When the remaining time has elapsed, a message will appear on the display to tell you that the door is unlocking.

*Ready* will appear on the display and an audible signal will sound as soon as the door has been unlocked.

- Confirm the message shown with *OK*.
- Select *Close*.
- Turn the oven off.

The audible signal will stop and the symbols on the display will go out.

# Cleaning and care of the oven

 Risk of injury caused by hot surfaces.

At the end of the Self Clean program, the oven will still be very hot. You could burn yourself on the heating elements, oven compartment, or accessories.

Allow the heating elements, oven compartment, and accessories to cool down before removing any Self Clean residues or oiling the side runners.

- Clean the oven compartment and accessories suitable for the Self Clean program to remove any Self Clean residues (e.g., ash) that can build up depending on the degree of soiling in the oven compartment.
- Add a few drops of heat-resistant cooking oil to some kitchen paper and use this to lubricate the side runners.

Most soiling can be easily removed using a clean, soft sponge and a mild solution of warm water and liquid dish soap.

Depending on how dirty the oven was prior to cleaning, there may be a visible layer of soiling across the inner glass pane on the door. You can remove this using the scouring side of a dish sponge, a glass scraper, or with a stainless-steel spiral pad and liquid dish soap.

There is a fiberglass seal around the oven compartment which seals the inside of the glass oven door and can be damaged by rubbing and scouring.

Avoid cleaning the fiberglass seal. The fiberglass seal is essential for sealing the door properly.

Spilled fruit juices may cause lasting discoloration of enameled surfaces. This discoloration is permanent but will not affect the properties of the enamel.

Do not attempt to remove these marks.

## Self Clean interrupted

If the Self Clean program is cancelled, the oven door will remain locked until the temperature inside the oven drops to below 535°F (280°C).

The following events will cause the Self Clean program to stop:

- Turning the oven off.

If you turn the oven off, Self clean program cancelled will appear on the display.

- A power failure.

Once the power returns after a power failure, Self clean program cancelled will appear on the display.

The door will unlock once the temperature in the oven has dropped below 535°F (280°C), and the oven is turned off.

# Cleaning and care of the oven

## Removing the door

The door weighs approx. 48.5 lbs (22 kg).

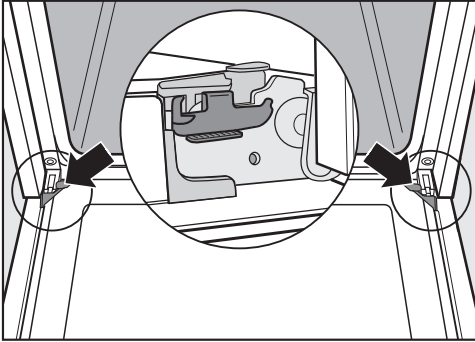

The oven door is connected to the hinges by retainers. Before removing the door from the retainers, the locking clamps on both hinges have to be released.

- Open the door fully.

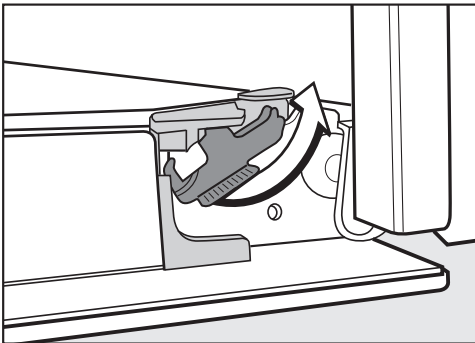

- Release the locking clamps by turning them as far as they will go.

You could damage the oven if you remove the door incorrectly. Do not pull the door horizontally off its retainers, as they will spring back against the oven. Do not pull the door off the retainers by the handle, as the handle could break off.

- Raise the door up till it rests partially open.



- Hold the door on either side and pull it upwards off the hinge retainers. Make sure that the door is straight.

# Cleaning and care of the oven

## Installing the door

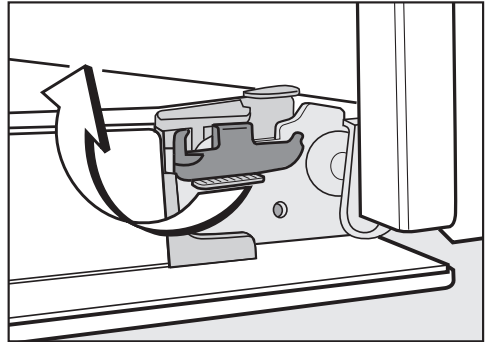
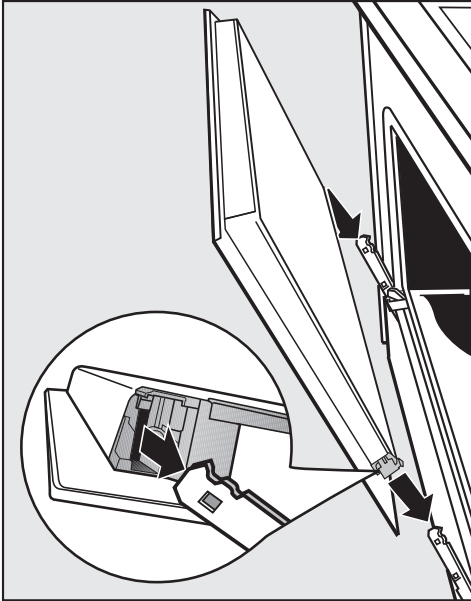

- To relock the locking clamps, turn them back up to the horizontal position as far as they will go.

- Hold the door securely on both sides and carefully install it back into the hinge retainers. Make sure that you do not tilt the door.
- Open the door fully.

If the locking clamps are not locked, the door could become loose, resulting in damage.

Ensure that the locking clamps are locked after reinstalling the door.



## Side rack removal

 Danger of injury caused by hot surfaces.

The oven gets hot during operation. You could burn yourself on the heater elements, oven compartment, or accessories.

Allow the heating elements, oven compartment, and accessories to cool before removing the side racks.

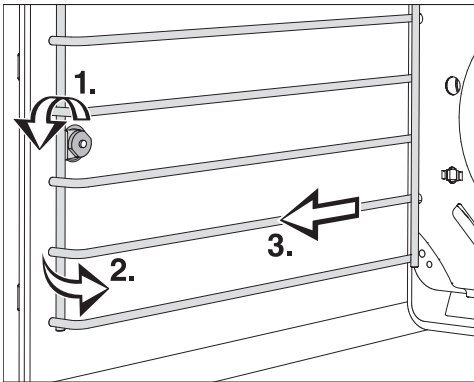

- Loosen the knurled screw (1.).
- Pull the side racks forwards out of the holder (2.).
- Remove the side racks (3.).

**Reinstall** by following these instructions in reverse order.

- Insert the components carefully.

## Frequently Asked Questions

---

With the help of the following guide minor faults in the performance of the machine, some of which may result from incorrect operation, can be remedied without contacting the Service Department.





This guide may help you to find the reason for the fault, and how to correct it.

Problem	Possible cause and solution
<b>The burners do not ignite when the cooktop is being used for the first time or after it has been out of use for a longer period.</b>	There may be air in the gas line. ■ Try to light the burner again, making several attempts if necessary.
<b>The burner does not light after several attempts.</b>	The burner is not properly assembled. ■ Assemble the burner correctly.
	The gas shutoff valve is closed. ■ Open the gas shut-off valve.
	The burner is wet and/or dirty. ■ Clean and dry the burner.
	The flame holes are clogged and/or wet. ■ Clean and dry the flame holes.
<b>The gas flame goes out after being lit.</b>	The burner parts are not in the proper position. ■ Position the burner parts correctly.
	The ignitor is dirty. ■ Remove any dirt or grime.
<b>The shape/color of the gas flame changes.</b>	The burner parts are not in the proper position. ■ Position the burner parts correctly.
	The burner cap itself or the holes in the burner cap are dirty. ■ Remove any dirt or grime.
<b>The gas flame goes out during use.</b>	The burner parts are not in the proper position. ■ Position the burner parts correctly.

## Frequently Asked Questions

Problem	Possible cause and solution
<p><b>The ignitor does not function properly.</b></p>	<p>The breaker in the building's wiring system has tripped.</p> <ul style="list-style-type: none"> <li>■ Contact a qualified electrician or Miele Customer Service if necessary.</li> </ul>
	<p>There is food residue stuck between the ignitor and the burner cap.</p> <ul style="list-style-type: none"> <li>■ Remove any soiling (See "Gas cooktop cleaning and care").</li> </ul>
<p><b>Grill and griddle plate switch off/cannot be switched on</b></p>	<p>The grill and griddle plate will be switched off as soon as you start the Self Clean program on the oven.</p> <p>This is not a fault. This has triggered the safety shut-off.</p> <ul style="list-style-type: none"> <li>■ Turn the control knob for the grill and griddle plate to <i>Off</i>. As soon as the Self Clean program has finished, you can switch the grill and griddle plate back on again.</li> </ul>
	<p>The grill and griddle plate cannot be turned on while the Self Clean program is running on the oven.</p> <p>This is not a fault. This has triggered the safety shut-off.</p> <ul style="list-style-type: none"> <li>■ Turn the control knob for the grill and griddle plate to <i>Off</i>. As soon as the Self Clean program has finished, you can switch the grill and griddle plate back on again.</li> </ul>
<p><b>Grill and griddle plate cannot be switched back on immediately after switching off</b></p>	<p>The appliance performs a safety check before the ignitor ignites.</p> <p>This is not a fault. After a few seconds, the ignitor will "click" and ignite the gas.</p> <ul style="list-style-type: none"> <li>■ Push in the control knob for the grill or griddle plate and turn it counterclockwise to <i>High</i> until the burner ignites.</li> </ul>
<p><b>With cooktops using LP gas a buzzing noise can be heard during the heating-up phase.</b></p>	<p>This is not a fault. The noise will cease after a few seconds.</p>



## Frequently Asked Questions

Problem	Possible cause and solution
<p><b>The display is dark.</b></p>	<p>You have selected the <b>Time   Display   Off</b> setting. When the appliance is turned off, the time-of-day display is turned off.</p> <ul style="list-style-type: none"> <li>■ As soon as the oven is turned on, the main menu will appear. If you want the time of day to be displayed constantly, select the <b>Time   Display   On</b> setting.</li> </ul> <hr/> <p>There is no power to the appliance.</p> <ul style="list-style-type: none"> <li>■ Check if the breaker has tripped. If it has, contact a qualified electrician or Miele Customer Service.</li> </ul>
<p><b>The audible signal does not sound.</b></p>	<p>The audible signals are deactivated or set at too low a volume.</p> <ul style="list-style-type: none"> <li>■ Turn on the audible signals or increase the volume with <b>Settings   Volume   Buzzer Tones</b>.</li> </ul>
<p><b>The oven does not heat up.</b></p>	<p>Demo mode is activated. You can select menu options on the display and sensor buttons, but the oven heating does not work.</p> <ul style="list-style-type: none"> <li>■ Deactivate Demo mode by selecting <b>Settings   Showroom Program   Demo Mode   Off</b>.</li> </ul>
<p><b>System Lock  appears on the display when the oven is turned on.</b></p>	<p>The  system lock is activated.</p> <ul style="list-style-type: none"> <li>■ You can deactivate the system lock for a cooking program by touching the  symbol for at least 6 seconds.</li> <li>■ If you want to permanently deactivate the system lock, select the <b>Safety   System Lock    Off</b> setting.</li> </ul>

## Frequently Asked Questions

Problem	Possible cause and solution
<p><b>The sensor buttons or the proximity sensor do not respond.</b></p>	<p>You have selected the Display   QuickTouch   Off setting. When this is activated, the sensor buttons and proximity sensor do not respond when the oven is turned off.</p> <ul style="list-style-type: none"> <li>■ As soon as the oven is turned on, the sensor buttons and the proximity sensor will respond. If you want the sensor buttons and the proximity sensor to respond even when the oven is turned off, select the Display   QuickTouch   On setting.</li> </ul>
	<p>The settings for the proximity sensor are turned off.</p> <ul style="list-style-type: none"> <li>■ Change the settings for the proximity sensor by selecting Settings   MotionReact.</li> </ul>
	<p>The proximity sensor is defective.</p> <ul style="list-style-type: none"> <li>■ Contact Miele Customer Service.</li> </ul>
	<p>The oven is not connected to the domestic electrical supply.</p> <ul style="list-style-type: none"> <li>■ Make sure that the plug is correctly inserted in the socket and that the socket switch has been switched to on.</li> <li>■ Check if the breaker has tripped. If it has, contact a qualified electrician or Miele Customer Service.</li> </ul>
	<p>If the display does not respond, there is a fault with the controls.</p> <ul style="list-style-type: none"> <li>■ Touch and hold the  On/Off button until the display turns off and the oven restarts.</li> </ul>
<p>Power failure -Program cancelled <b>appears on the display.</b></p>	<p>There has been a brief power failure. This has caused the current cooking process to stop.</p> <ul style="list-style-type: none"> <li>■ Turn the oven off and then back on again.</li> <li>■ Restart the cooking process.</li> </ul>
<p>12:00 <b>appears on the display.</b></p>	<p>There was a power failure for more than 150 hours.</p> <ul style="list-style-type: none"> <li>■ Reset the date and time.</li> </ul>
<p>Maximum operating duration reached <b>appears on the display.</b></p>	<p>The oven has been operating for an unusually long time. This has triggered the safety shut-off.</p> <ul style="list-style-type: none"> <li>■ Confirm with OK.</li> </ul> <p>The oven is now ready to use again.</p>

## Frequently Asked Questions

Problem	Possible cause and solution
<p> Fault F32 <b>appears on the display.</b></p>	<p>The door lock for the Self Clean program has not locked.</p> <ul style="list-style-type: none"> <li>■ Turn the oven off and then back on again. Start the Self Clean program again.</li> <li>■ If the message appears again, contact Miele Customer Service.</li> </ul>
<p> Fault F33 <b>appears on the display.</b></p>	<p>The door lock for the Self Clean program has not opened.</p> <ul style="list-style-type: none"> <li>■ Turn the oven off and then back on again.</li> <li>■ If the door lock still does not deactivate itself, contact Miele Customer Service.</li> </ul>
<p>Fault <b>and a fault code not listed here appear on the display.</b></p>	<p>A fault has occurred that you cannot resolve.</p> <ul style="list-style-type: none"> <li>■ Contact Miele Customer Service.</li> </ul>
<p>No signal to the probe. Reposition the probe in the oven. <b>appears on the display.</b></p>	<p>The probe is not being recognized.</p> <ul style="list-style-type: none"> <li>■ Reposition the probe in the food.</li> </ul> <p>If the probe is still not being recognized, the signal has failed due to another cause.</p> <hr/> <p>In some cases, reception interference can even be caused by a microwave operating in the vicinity of the oven, because the microwave uses a similar frequency range to that of the wireless probe.</p> <ul style="list-style-type: none"> <li>■ Turn off the microwave when you are using the wireless probe.</li> </ul> <p>If the probe is still not being recognized, it is faulty. You can purchase a new probe from your Miele dealer or from Miele Customer Service.</p>
<p>Fault with moisture control - the automatic programs will operate without moisture <b>appears on the display after you have selected a automatic program.</b></p>	<p>The steam injection system is faulty.</p> <ul style="list-style-type: none"> <li>■ Contact Miele Customer Service.</li> </ul> <p>Automatic programs can be run without using moisture injection.</p>
<p><b>You can hear a noise after a cooking program.</b></p>	<p>The cooling fan remains turned on after a cooking program (see “Settings – Cooling fan run-on”).</p>

## Frequently Asked Questions

Problem	Possible cause and solution
<b>The oven has turned itself off.</b>	<p>To save power, the oven turns off automatically if a button is not pressed after a certain amount of time or after a cooking program has ended.</p> <ul style="list-style-type: none"> <li>■ Turn the oven back on.</li> </ul>
<b>The cake/cookies are not baked properly.</b>	<p>A different temperature than that given in the recipe was used.</p> <ul style="list-style-type: none"> <li>■ Select the temperature required for the recipe.</li> </ul>
	<p>The ingredient quantities are different from those given in the recipe.</p> <ul style="list-style-type: none"> <li>■ Check if you have amended the recipe. The addition of more liquid or more eggs will make a wetter mixture which will take longer to cook.</li> </ul>
<b>The browning is uneven.</b>	<p>You selected the wrong temperature or shelf level.</p> <ul style="list-style-type: none"> <li>■ There will always be a slight unevenness. If browning is very uneven, check whether you selected the correct temperature and shelf level.</li> </ul>
	<p>The material or color of the bakeware is not suitable for the operating mode selected.</p> <ul style="list-style-type: none"> <li>■ When using the Surround  operating mode, light-colored, shiny baking pans will not produce as desirable results. Dark, matte baking pans are best for baking.</li> </ul>
<b>There is still soiling in the oven compartment after a Self Clean program.</b>	<p>The Self Clean program burns off soiling in the oven and leaves it as ash.</p> <ul style="list-style-type: none"> <li>■ Remove the ash with warm water, liquid dish soap, and a clean sponge or a clean, damp microfiber cloth.</li> </ul> <p>If there is still coarse soiling left in the oven after the Self Clean program, you should start the program again, selecting a longer duration if necessary.</p>
<b>The accessories make noises when they are pushed into or pulled out of the oven.</b>	<p>The Self-Clean-resistant surface of the side runners creates friction when accessories are pushed into or pulled out of the oven.</p> <ul style="list-style-type: none"> <li>■ To reduce the friction, add a few drops of heat-resistant cooking oil to some kitchen paper and use this to lubricate the side runners. Repeat this after every Self Clean program.</li> </ul>

## Frequently Asked Questions

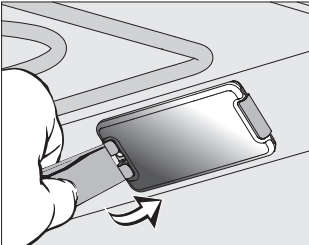
Problem	Possible cause and solution
<p>The oven interior lighting turns off after a short time.</p>	<p>You have selected the Lighting   “On” for 15 seconds setting.</p> <ul style="list-style-type: none"> <li>■ If you want the oven interior lighting to remain on during the entire cooking program, select the Lighting   On setting.</li> </ul>
<p>The oven interior lighting is off or does not turn on.</p>	<p>You have selected the Lighting   Off setting.</p> <ul style="list-style-type: none"> <li>■ Press the <i>Light</i> sensor button to turn the oven interior lighting on for 15 seconds.</li> <li>■ If required, select the Lighting   On or “On” for 15 seconds setting.</li> </ul>
<p>The oven interior lighting does not turn on.</p> 	<p>The halogen lamp is faulty.</p> <div style="border: 1px solid gray; padding: 5px; margin-bottom: 10px;"> <p><b>⚠ Danger of injury caused by hot surfaces.</b> The oven gets hot during operation. You could burn yourself on the heater elements, oven compartment, or accessories. Allow the heater elements, oven compartment, and accessories to cool before manual cleaning.</p> </div> <div style="border: 1px solid gray; padding: 5px; margin-bottom: 10px;"> <p>The lamp cover may be damaged if it falls down. Hold onto the lamp cover while removing it so it does not fall down. Place a cloth over the oven floor to protect it and the open door.</p> </div> <ul style="list-style-type: none"> <li>■ Disconnect the oven from the electrical supply. Unplug the appliance or switch off the breaker.</li> <li>■ Remove the lamp cover from the frame from behind with the tool supplied.</li> <li>■ Do not grasp the halogen lamp with your bare fingers. Please follow the manufacturer’s instructions. Remove the halogen lamp.</li> <li>■ Replace the halogen lamp (Osram 66725 AM/A, 230 V, 25 W, G9).</li> <li>■ Press the lamp cover back into place.</li> <li>■ Reconnect the oven to the electrical supply.</li> </ul>



## Contact in the event of a fault

In the event of a fault which you cannot remedy yourself, please contact your Miele dealer or Miele Customer Service.

You can book a Miele Service Call online at [www.miele.com/service](http://www.miele.com/service).

Contact information for Miele Customer Service can be found at the end of this document.

Please quote the model identifier and serial number of your appliance (SN) when contacting Miele Customer Service. Both pieces of information can be found on the data plate.

## Data plate

The data plate is located behind the toe kick panel. The toe kick panel is attached to the toe kick of the Range by magnets so it can be removed and put back again easily.

There you can find the model number, serial number and the connection data (voltage/frequency/maximum rated load) for your Range.

Have this information available if you need to contact Miele so that any issues can be rectified as quickly as possible.

## Appliance warranty and product registration

You can register your product and/or view the manufacturer's warranty terms and conditions for Miele appliances and vacuum cleaners at [www.mieleusa.com](http://www.mieleusa.com).

# Caring for the environment

---

## Disposal of the packing material

The cardboard box and packing materials protect the appliance during shipping. They have been designed to be biodegradable and recyclable.

Ensure that any plastic wrappings, bags, etc. are disposed of safely and kept out of the reach of children.  
Danger of suffocation!

## Disposal of your old appliance

Electrical and electronic appliances contain valuable materials. They also contain certain substances, compounds and components which were essential for the proper functioning and safe use of the equipment. Handling these materials improperly by disposing of them in your household waste can be harmful to your health and the environment. Therefore, please do not dispose of your old appliance with regular household waste and follow local regulations on proper disposal.



Consult with local authorities, dealers or Miele in order to dispose of and recycle electrical and electronic appliances. Miele assumes no responsibility for deleting any personal data left on the appliance being disposed. Please ensure that your old appliance is kept away from children until removal. Observe safety requirements for appliances that may tip over or pose an entrapment hazard.

# Declaration of conformity

## Radio Modules

This device contains the following food probe radio module:

FCC ID	SSVNAEPI02
IC ID	5669B-NAEPI02
Frequency band	2.401 GHz – 2.481 GHz
Maximum transmitting power	120 mW

and the following WiFi modules:

FCC ID	2AC7Z-EK057
IC ID	21098-EK057
Frequency band	2.412 GHz – 2.462 GHz
Maximum transmitting power	< 0.2 W

## Compliance Statement

This device complies with Part 15 of the FCC Rules and contains licence-exempt transmitter(s)/receiver(s) that comply with Innovation, Science and Economic Development Canada's licence-exempt RSS Standard(s). Operation is subject to the following two conditions:

- (1) this device may not cause harmful interference, and
- (2) this device must accept any interference received, including interference that may cause undesired operation.

The construction of the device assures that the FCC/IC exposure limits are verifiably met using the integrated radio modules.



### Warning!

Any changes or modifications to this unit not expressly approved by the party responsible for compliance could void the user's authority to operate the equipment.

## Copyrights and licenses

---

For the purpose of operating and controlling the communication module, Miele uses proprietary or third-party software that is not covered by open source licensing terms. This software/these software components are protected by copyright. The copyrights held by Miele and third parties must be respected.

In addition, the integrated communication module contains software components which are distributed under open source licensing terms. You can access these open source components along with the associated copyright notices, copies of the valid licensing terms, and any additional information locally via IP using a web browser ([http\[s\]://<ip address>/Licenses](http[s]://<ip address>/Licenses)). The liability and warranty arrangements for the open source licenses displayed in this location only apply in relation to the respective rights holders.





**Please have the model and serial number  
of your appliance available when  
contacting Customer Service.**

---

## **U.S.A.**

**Miele, Inc.**

### **National Headquarters**

9 Independence Way  
Princeton, NJ 08540  
[www.mieleusa.com](http://www.mieleusa.com)

### **Customer Support**

Phone: 888-99-MIELE (64353)  
[info@mieleusa.com](mailto:info@mieleusa.com)

### **International Headquarters**

Miele & Cie. KG  
Carl-Miele-Straße 29  
33332 Gütersloh  
Germany

## **Canada**

**Importer  
Miele Limited**

### **Headquarters and Miele Centre**

161 Four Valley Drive  
Vaughan, ON L4K 4V8  
[www.miele.ca](http://www.miele.ca)

### **Customer Care Centre**

Phone: 1-800-565-6435  
905-532-2272  
[customercare@miele.ca](mailto:customercare@miele.ca)

HR 1934-3 DF, HR 1935-3 DF, HR 1936-3 DF

en-US, CA

M.-Nr. 11 919 030 / 04