



30" Front Control Electric Range

Electric Range

Available Products: FCFE3062AB, FCFE3062AS, FCFE3062AW

Available Colors: Black, Stainless Steel, White

Version: 10/22

Product Specifications

Cooktop

Cooking Surface Type	Smooth
Element On Indicator Light	Yes
Hot-Surface Indicator Light	Yes

Cooking Controls

Bake	Yes
Broil	Yes
Cancel	Yes
Clear Off	Yes
Clock	Yes
Cook Time	Yes
Delay Start	Yes
Keep Warm	Yes
Kitchen Timer	Yes
Lockout	Yes
On / Off (for each element)	Yes
Oven Light	Yes
Preheat	Yes
Probe	No
Steam Clean	Yes
Temperature Display	Yes
Timed Bake	Yes
Timer On / Off	Yes
Warm Zone	Yes

Oven

Bake Element	2,500 Watts
Bake Element Pass	8
Bake Element Type	Hidden
Bake System	Yes
Broil Element	3,000 Watts
Broil Element Pass	4
Broil System	Yes
Cleaning System	Yes
Number of Rack Positions	6
Oven Interior Color	Midnight Black
Oven Light Quantity	1
Oven Light Type	Halogen
Oven Light Watts	40 Watts
Rack Position Type	Embossed
Rack Type 1	Flat
Rack Type 1 Quantity	2

Cooktop Performance

Right Front Element Burner Size	9"
Right Rear Element Burner Size	6"
Left Front Element Burner Size (Small)	6"
Left Front Element Burner Size (Large)	9"
Left Rear Element Burner Size	6"
Right Front Element Burner	3,200 Watts
Right Rear Element Burner	1,200 Watts
Left Front Element Burner (Small)	1,400 Watts
Left Front Element Burner (Large)	3,000 Watts
Left Rear Element Burner	1,200 Watts
Center Rear Element Burner	100 Watts

Cooking Controls Function

Delayed Bake	Yes
Program Fahrenheit or Celsius	Yes
Silent Control Panel	Yes

Drawer

Drawer Handle Style	Integrated
Drawer Type	Storage

Display

Control Location	Front
Display Interface Color	White
Display Type	Capacitive Touch

Electrical Specifications

Connected Load @ 240V	13 kW
Minimum Circuit Required	40 Amps
Voltage Rating	240 V

Certifications and Approvals

ADA Compliant	Yes
---------------	-----

Available Products: FCFE3062AB, FCFE3062AS,

Available Colors: Black, Stainless Steel, White

FCFE3062AW

Version: 10/22

Controls

Control Lock	No
Sabbath Mode	No

Dimensions and Volume

Minimum Height	35 5/8"
Maximum Height	36 3/8"
Width	30"
Depth	26"
Depth With Door 90° Open	47 5/16"
Depth With Handle	28 1/2"
Oven Interior Height	18 1/8"
Oven Interior Width	25 3/16"
Oven Interior Depth	19 7/8"
Oven Capacity	5.3 Cu. Ft.

General Specifications

Prop 65 Label	Yes
Warranty - Labor	1 Year
Warranty - Parts	1 Year

Safety Certifications and Approvals

UL Listed	Yes
cUL Listed	Yes

Installation Diagram

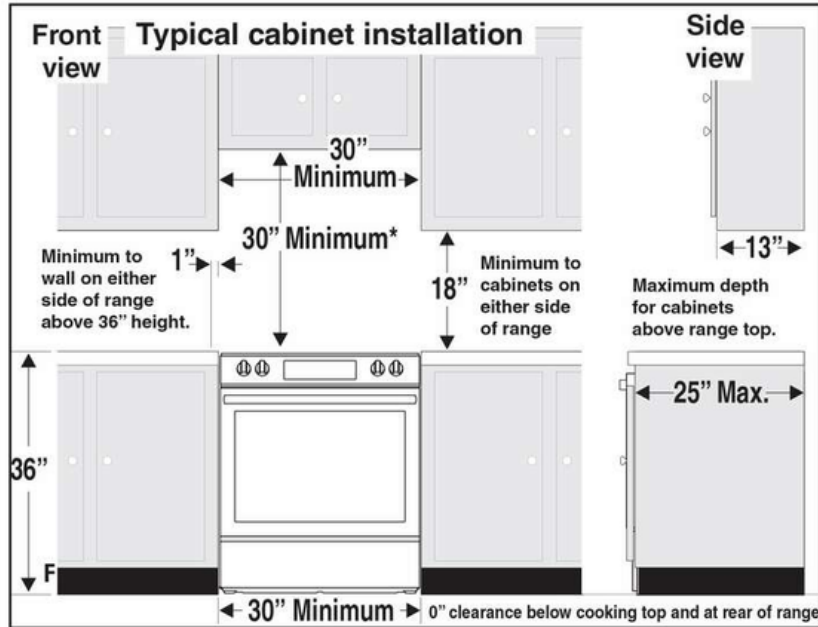

Fig. 1

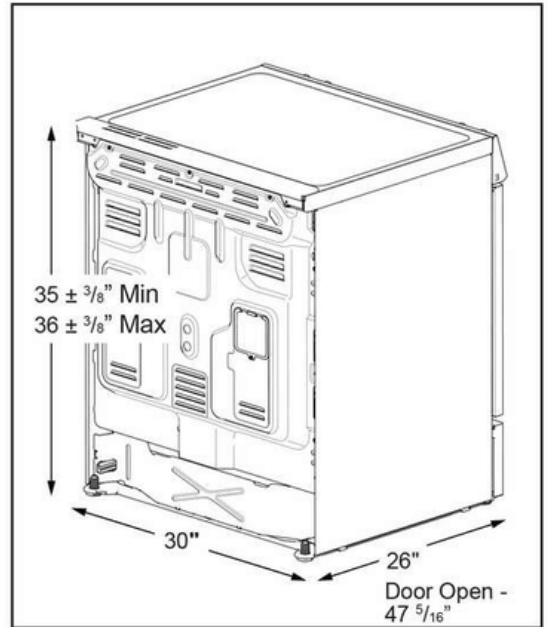

Fig. 2

*30" (762 mm) MINIMUM CLEARANCE BETWEEN THE TOP OF THE COOKING SURFACE AND THE BOTTOM OF AN UNPROTECTED WOOD OR METAL CABINET; OR 24" (610 mm) MINIMUM WHEN BOTTOM OF WOOD OR METAL CABINET IS PROTECTED BY NOT LESS THAN 1/4" (6 mm) FLAME RETARDANT MILLBOARD COVERED WITH NOT LESS THAN NO. 28 MSG SHEET STEEL, 0.015" (0.4 mm) STAINLESS STEEL, 0.024" (0.6 mm) ALUMINUM OR 0.020" (0.5 mm) COPPER. 0" (0 mm) CLEARANCE IS THE MINIMUM FOR THE REAR OF THE RANGE. FOLLOW ALL DIMENSION REQUIREMENTS PROVIDED ABOVE TO PREVENT PROPERTY DAMAGE, POTENTIAL FIRE HAZARD, AND INCORRECT COUNTERTOP AND CABINET CUTS.

TO ELIMINATE THE RISK OF BURNS OR FIRE BY REACHING OVER HEATED SURFACE UNITS, CABINET STORAGE SPACE LOCATED ABOVE THE SURFACE UNITS SHOULD BE AVOIDED. IF CABINET STORAGE IS TO BE PROVIDED, THE RISK CAN BE REDUCED BY INSTALLING A RANGE HOOD THAT PROJECTS HORIZONTALLY A MINIMUM OF 5" (127 mm) BEYOND THE BOTTOM OF THE CABINETS.

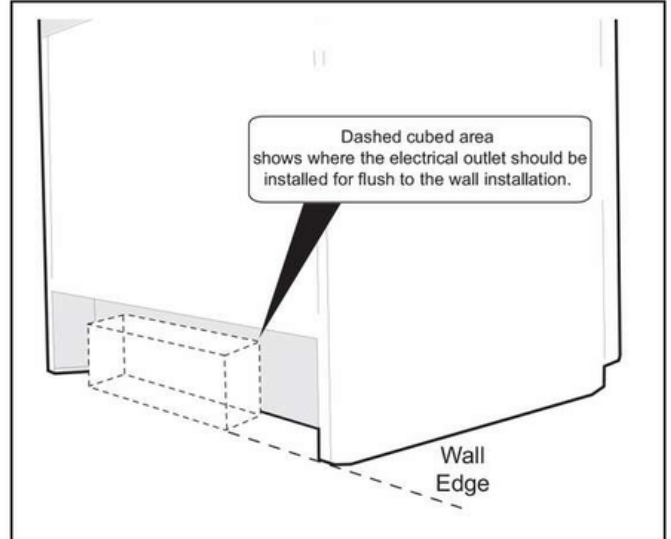

Fig. 3