

# CR24

## USE & CARE GUIDE



### PERLICK COLLECTION 24" COLUMN REFRIGERATION

To prevent appliance damage and injury, read these instructions thoroughly prior to operation.

CONTENTS

- 3 Introduction
- 4 Touch-screen Controller Operation
  - 4 Refrigerator
  - 8 Freezer
  - 10 Wine Reserve
- 13 Freezer Ambient Conditions
- 14 Stainless Steel/Surface Care
- 15 Adjusting the Wine Shelves
- 16 Filter Installation
- 17 Troubleshooting
- 19 Warranty
- 21 Contact Us

THANK YOU FOR CHOOSING PERLICK

Congratulations on the purchase of your Perlick home appliance. Perlick’s innovative refrigeration product offering gives you the professional performance and functionality demanded in commercial kitchens and beyond. As a fifth-generation, family-owned company, our appliances reflect the quality and craftsmanship that we demand in our own homes.

Perlick has been designing, engineering and manufacturing award-winning products for the commercial food/beverage service industry for over 100 years. Our award-winning products are trusted by bars, restaurants, hotels and large venues around the world because a Perlick is built to last. Your Perlick home appliance is built with beauty and durability for a lifetime of use. This use and care guide will show you how to properly operate and care for your new Perlick product.

We dedicate a considerable amount of time ensuring each and every one of our products provide you the highest level of customer satisfaction. If, however, service is required at any point, call Perlick at (800) 558-5592. For your own protection, never return merchandise for credit without Perlick approval.

Perlick proudly offers the industry’s most comprehensive product warranty (see page 19). Enjoy a three full year warranty by registering your product at **[www.perlick.com/RegisterMyPerlick](http://www.perlick.com/RegisterMyPerlick)**. Be sure to register your product immediately upon installation to receive the warranty from installation date instead of shipment date. If left blank, the date will revert back to shipment date. Thank you again for selecting a Perlick home appliance for your home!

Need to order replacement filters for your CR24 Column Refrigerator or Wine Reserve?  
Contact your selling dealer or visit **[perlick.com/residential](http://perlick.com/residential)** to find a Perlick dealer near you.

**INTRODUCTION**

**ABOUT THIS GUIDE**

This Use & Care Guide pertains to all Perlick CR24 Column Refrigeration models.

Keep this manual in a safe place for future reference. To better serve you, record your product’s information below, as we will request this information in the event you need assistance.

Model Number: \_\_\_\_\_

Serial Number: \_\_\_\_\_

Selling Dealer Name: \_\_\_\_\_

Selling Dealer Phone Number: \_\_\_\_\_

Sold Date: \_\_\_/\_\_\_/\_\_\_\_\_ Installation Date: \_\_\_/\_\_\_/\_\_\_\_\_

**PRODUCT IDENTIFICATION PLATE**

Your product information can be found on the product’s identification plate. The identification plate for CR24 column refrigeration models is located on the sidewall behind the toe kick plate. To access the identification plate, simply remove the toe kick plate (grill). The identification plate will be adhered to the right sidewall.

**SAFETY PRECAUTIONS**

Please take note of the following safety precautions prior to using your Perlick CR24 column refrigerator, freezer or wine reserve.

- Perlick column refrigeration is heavy. With a weight of up to 550 lbs., it is imperative that the unit is properly installed and that the anti-tip brackets are fully engaged.
- Do not use or store flammable liquids (ie; gasoline) or vapors near the appliance.
- Take special care to keep fingers away from pinch points such as the hinges and gaps between the door and cabinets. This can result in injury, especially to young children.
- Unplug the refrigerator prior to cleaning or performing technical service.
- In the event your unit needs repair, repair work must be performed by a Perlick authorized servicer. Work done by unauthorized individuals could potentially be dangerous and will void the warranty.

**TOUCH-SCREEN CONTROL OPERATION - REFRIGERATOR MODELS**

**REFRIGERATOR CONTROL OPERATION**

The following instructions are for the touch-screen control in Perlick column refrigerators (model CR24R).

Control shown fully illuminated below for illustration purposes only.

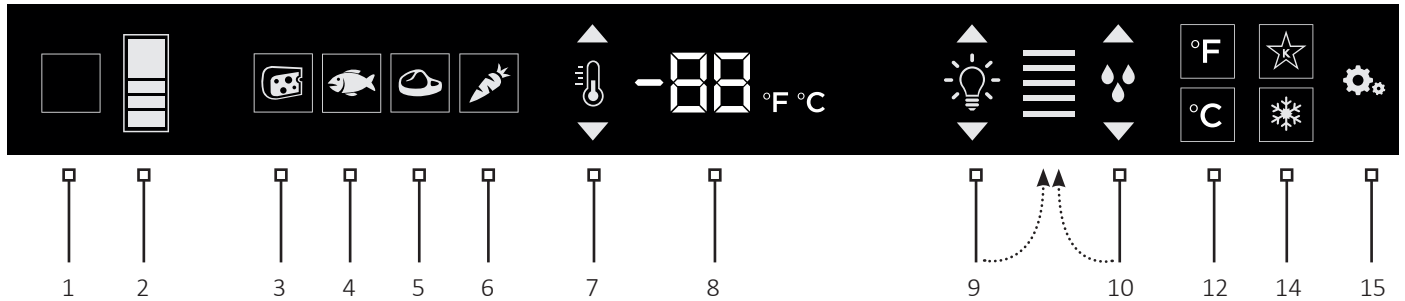

- 1 Wake Button
- 2 Temperature zone selection
- 3 Deli temperature setting
- 4 Fish/Seafood temperature setting
- 5 Meat temperature setting
- 6 Fresh Produce temperature setting
- 7 Temperature adjustment (*up and down in 1° increments*)
- 8 Temperature readout
- 9 Light intensity adjustment
- 10 Humidity control adjustment
- 11 Fahrenheit temperature mode
- 12 Celsius temperature mode
- 13 Sabbath mode
- 14 QuickCool mode
- 15 Settings menu

**Using the Refrigerator Column Control**

Upon door opening, the Wake button (1) outline will illuminate. Once activated, the temperature zone selection (2), temperature adjustment (7), temperature readout (8) and settings (15) menu icons will illuminate.

**Selecting a Temperature Zone**

Perlick’s touch-screen controller is preset with recommended temperature settings for various goods. Within these presets, you have the ability to adjust the temperature in 1° increments as you desire.

Press the temperature zone selection (2) icon to toggle through the zones until desired zone is illuminated. Zone and preset icon will illuminate to prompt you to store certain goods in that particular zone as shown below:

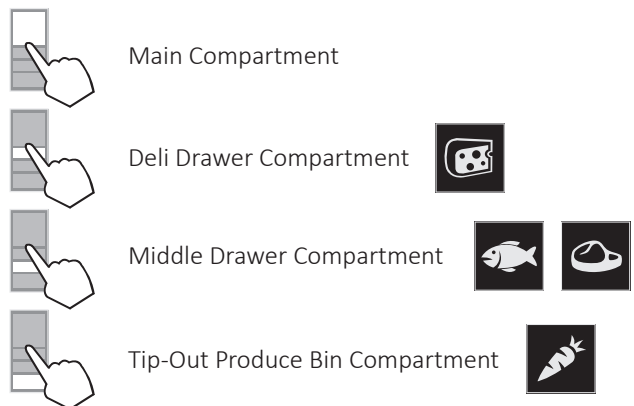

**TOUCH-SCREEN CONTROL OPERATION - REFRIGERATOR MODELS**

**Main Compartment**

The main compartment of the refrigerator features two full-width shelves and a split shelf that can be adjusted to fit tall items. Because this is a common zone that doesn't store specific items, only the temperature adjustment (7) and temperature readout (8) will illuminate- no specialty temperature settings (Sp.) will appear.

Compartment	Sp.	Factory Setting	Temperature Range
<b>Main</b>	<b>N/A</b>	<b>38°F</b>	<b>34°F - 42°F</b>

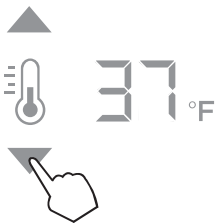

The main compartment of the refrigerator will come set from the factory to 38°F. To adjust the temperature up or down, press the temperature adjustment (7) arrows until desired temperature is reflected in the temperature readout (8). Double beep indicates that minimum or maximum temperature has been reached. Temperature will flash twice to indicate the new setting.

**Top Drawer Compartment**

The deli compartment (top drawer) of the refrigerator features a two-tier design for storing and displaying charcuterie items such as artisan meats and cheeses. When this zone is chosen, the charcuterie (cheese) temperature setting (3), temperature adjustment (7) and the temperature readout (8) will illuminate.

Compartment	Sp.	Factory Setting	Temperature Range
<b>Deli Drawer</b>		<b>33°F</b>	<b>32°F - 37°F</b>





The two-tier charcuterie(deli) drawer of the refrigerator will come set from the factory at 33°F. To adjust the temperature up or down, press the temperature adjustment (7) arrows until desire temperature is reflected

in the temperature readout (8). Double beep indicates that the minimum or maximum temperature has been reached. Temperature will flash twice to indicate new setting.

**Middle Drawer Compartment**

The middle drawer compartment of the refrigerator features a full-width drawer designed for storing meat and seafood. When this zone is chosen, the fish/seafood (fish) temperature setting (4), meat (steak) temperature setting (5), temperature adjustment (7) and temperature readout (8) will illuminate.

Compartment	Sp.	Factory Setting	Temperature Range
<b>Middle</b>		<b>33°F</b>	<b>32°F - 37°F</b>
<b>Middle</b>		<b>35°F</b>	<b>32°F - 37°F</b>



The middle drawer compartment of the refrigerator will come set from the factory to 35°F (meat). If storing fish or other types of seafood, press the fish icon to bring the drawer to the preset mode of 33°F.

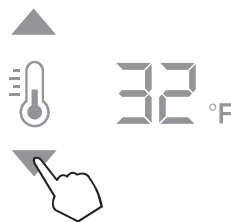

As with the other compartments, you have the ability to raise or lower the temperature in 1°F increments. To adjust the temperature up or down, press the temperature adjustment (7) arrows until desired temperature is reflected in the temperature readout (8). Double beep indicates that minimum or maximum temperature has been reached. Temperature will flash twice to indicate new setting.

**TOUCH-SCREEN CONTROL OPERATION - REFRIGERATOR MODELS**

**Bottom Drawer Compartment**

The bottom drawer compartment of the refrigerator features a unique tip out bin design for storing fresh produce. When this zone is chosen, the fresh produce (carrot) temperature setting (6), temperature adjustment (7) and temperature readout (8) will illuminate. In addition to temperature-related icons, the humidity control adjustment (10) icon will also illuminate.

Compartment	Sp.	Factory Setting	Temperature Range
Tip-out Produce Bin		35°F	32°F - 37°F

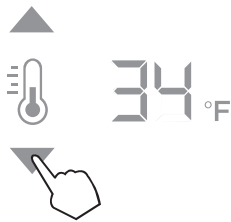

As with the other compartments, you have the ability to raise or lower the temperature in 1°F increments. To adjust the temperature up or down, press the temperature adjustment (7) arrows until desired temperature is reflected in the temperature readout (8).

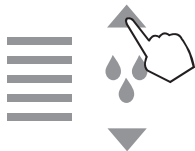

The tip-out produce bin also features a comprehensive humidity system that delivers real moisture based on your desired humidity levels. This keeps produce such as leafy greens fresher for longer. The humidity is factory set to 80%, but can be adjusted up and down in 10% increments between 50% and 90% by pressing the up or down arrows in the humidity control adjustment icon (10). The more bars that illuminate, the higher the humidity setting. Double beep indicates that the minimum or maximum level has been reached. Icons will flash twice to indicate new setting.

**Column Theatre Lighting**

Perlick column refrigerators feature an impressive amount of lighting for clear viewing and display of goods. Main lighting runs vertically down the walls and horizontally across the ceiling of the main compartment, deli drawer, meat/fish drawer and tip-out produce bin.

**Changing from Fahrenheit to Celsius scale**

The controller is factory set to Fahrenheit scale, but can easily be changed to read Celsius in the settings menu.



Press the settings menu (15) icon on the far right. This will illuminate a cluster of four icons as shown to the left. To display temperatures in Celsius, press the Celsius readout (12) icon.

Change will be reflected in the temperature readout (8). The C will be illuminated to signify the scale.

**Sabbath Mode**

All Perlick column refrigeration models have Sabbath mode capabilities. This allows the user to interact with the unit without changing the amount of energy it is using. In this mode, the interior lighting is turned off until user turns off Sabbath mode.

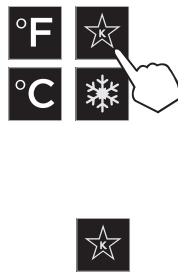

Press the settings menu (15) icon on the far right. This will illuminate a cluster of four icons as shown to the left. To activate Sabbath mode, press the Sabbath mode icon.

Please note that, when in Sabbath mode, the Sabbath mode (13) icon will be the only icon that will be illuminated (continuously) until user presses the Sabbath mode icon to turn the mode off.

**TOUCH-SCREEN CONTROL OPERATION - REFRIGERATOR MODELS**

**Quick Cool (Shopping) Mode**

The main compartment of the refrigerator can be set to Quick Cool (shopping) mode to lower the temperature after loading a large quantity of product to quickly bring them to the preferred temperature.



Press the settings menu (15) icon on the far right. This will illuminate a cluster of four icons as shown to the left. To activate Quick Cool (shopping) mode, press the Quick Cool (14) icon. This will activate the mode and the Quick Cool (14) will remain illuminated until the set point is achieved.

**Showroom Mode**

Select Showroom mode for units that are being used solely for display purposes. Showroom mode has the user interface fully functional along with the cabinet lights, however, no compressor, evaporator fans or condenser fans will operate.

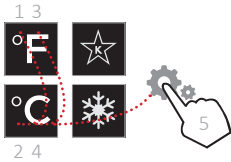

Press the settings menu (15) icon on the far right. This will illuminate a cluster of four icons as shown to the left. A 5 key combination\*, including the Fahrenheit readout (11) icon, Celsius readout (12) icon and settings menu (15) icon, will activate Showroom mode: F-C-F-C-Settings. Upon activating showroom mode, the temperature readout (7) with show Sh each time the door is opened until showroom mode is turned off.



To exit showroom mode, enter the 5 key combination.

*\*5 key combination must be completed within 5 seconds to turn showroom mode on and off.*

**TOUCH-SCREEN CONTROL OPERATION - FREEZER MODELS**

**FREEZER CONTROL OPERATION**

The following instructions are for the touch-screen control in Perlick column freezers (model CR24F).

Control shown fully illuminated below for illustration purposes only.

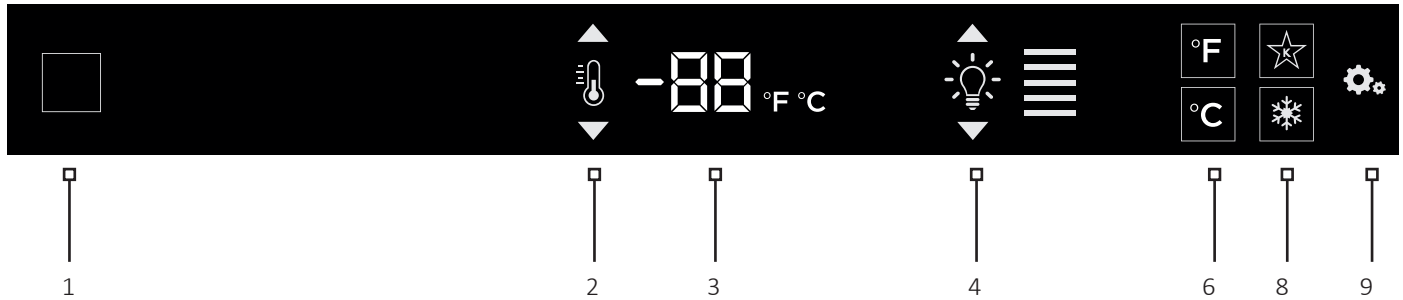

- 1 Wake Button
- 2 Temperature adjustment (*up and down in 1° increments*)
- 3 Temperature readout
- 4 Light intensity adjustment
- 5 Fahrenheit readout
- 6 Celsius readout
- 7 Sabbath mode
- 8 Quick cool mode
- 9 Settings menu

**Using the Freezer Column Control**

Upon door opening, the Wake button (1) outline will illuminate. Once activated, temperature adjustment (2), temperature readout (3) and settings (9) menu icons will illuminate.

**Freezer Temperature**

The freezer is the same temperature throughout, so only the temperature adjustment (2) and temperature readout (3) will illuminate.

Compartment	Sp.	Factory Setting	Temperature Range
All	N/A	0°F	-10°F - 10°F

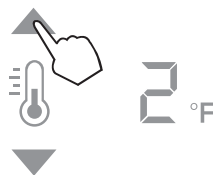

The freezer will come set from the factory to 0°F. To adjust the temperature adjustment (2) arrows until desired temperature is reflected in the temperature readout (3). Double beep indicates that minimum or maximum temperature has been reached. Temperature will flash twice to indicate new setting.



**TOUCH-SCREEN CONTROL OPERATION - FREEZER MODELS**

**Column Theatre Lighting**

Perlick column freezers feature an impressive amount of lighting for clear viewing and display of goods. White LED lighting runs vertically down the walls and horizontally across the ceiling of main compartment.

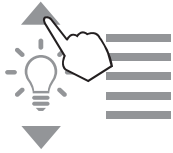

To adjust the brightness of the lighting when the door is opened, press the up and down arrows in the light intensity adjustment icon (4). Double beep indicates that minimum or maximum level has been reached. Icons will flash twice to indicate new setting.

**Changing from Fahrenheit to Celsius scale**

The controller is factory set to Fahrenheit scale, but can easily be changed to read Celsius in the settings menu.

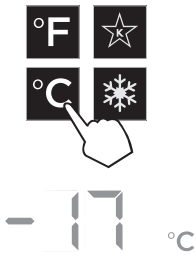

Press the settings menu (9) icon on the far left. This will illuminate a cluster of four icons as shown to the left. To display temperatures in Celsius, press the Celsius readout icon (6).

Change will be reflected in the temperature readout (3). The C will be illuminated to signify the scale.

**Sabbath Mode**

All Perlick column refrigeration models have Sabbath mode capabilities. This allows the user to interact with the unit without changing the amount of energy it is using. In this mode, the interior lighting is turned off until user turns off Sabbath mode.



Press the settings menu (9) icon on the far right. This will illuminate a cluster of four icons as shown to the left. To activate Sabbath mode, press the Sabbath mode icon (7).



Please note that, when in Sabbath mode, the Sabbath mode (7) icon will be the only icon that will be illuminated (continuously) until user presses the Sabbath mode icon to turn the mode off.

**Quick Cool (Shopping) Mode**

The main compartment of the freezer can be set to Quick Cool (shopping) mode to lower the temperature after loading a large quantity of product to quickly bring them to the preferred temperature.

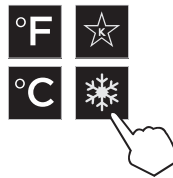

Press the settings menu (9) icon on the far right. This will illuminate a cluster of four icons as shown to the left. To activate Quick Cool (shopping) mode, press the Quick Cool (8) icon. This will activate the mode and the Quick Cool (8) will remain illuminated until the set point is achieved.

**Showroom Mode**

Select Showroom mode for units that are being used solely for display purposes. Showroom mode has the user interface fully functional along with the cabinet lights, however, no compressor, evaporator fans or condenser fans will operate.

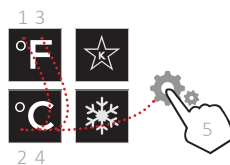

Press the settings menu (9) icon on the far right. This will illuminate a cluster of four icons as shown to the left. A 5 key combination\*, including the Fahrenheit readout (5) icon, Celsius readout (6) icon and settings menu (9) icon, will activate Showroom mode: F-C-F-C-Settings. Upon activating showroom mode, the temperature readout (7) will show Sh each time the door is opened until showroom mode is turned off.



To exit showroom mode, enter the 5 key combination.

*\*5 key combination must be completed within 5 seconds to turn showroom mode on and off.*

**TOUCH-SCREEN CONTROL OPERATION - WINE MODELS**

**WINE RESERVE CONTROL OPERATION**

The following instructions are for the touch-screen control in Perlick column wine reserves (model CR24W and CR24D).

Control shown fully illuminated below for illustration purposes only.

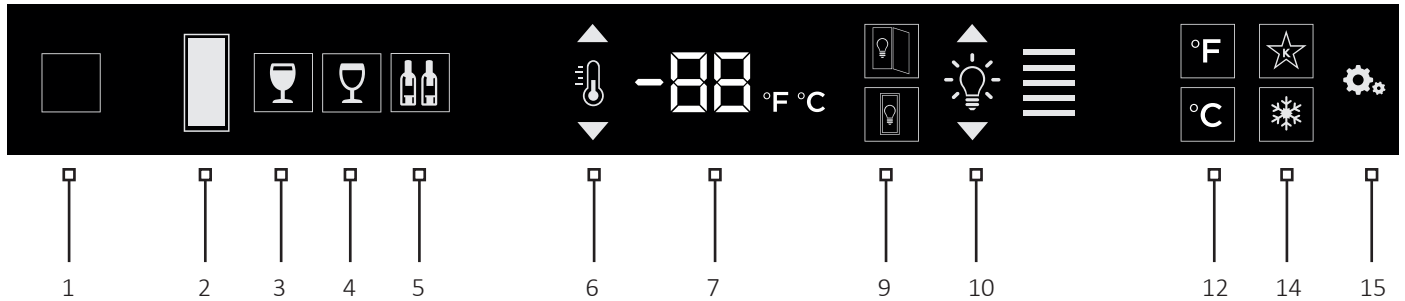

- 1 Wake Button
- 2 Temperature zone selection (Dual-zone models)
- 3 White wine temperature setting
- 4 Red wine temperature setting
- 5 Cellar temperature setting
- 6 Temperature adjustment (*up and down in 1° increments*)
- 7 Temperature readout
- 8 Light adjustment (door open)
- 9 Light adjustment (door closed)
- 10 Light intensity adjustment
- 11 Fahrenheit temperature mode
- 12 Celsius temperature mode
- 13 Sabbath mode
- 14 QuickCool mode
- 15 Settings menu

**Using the Wine Column Control**

Upon door opening, the Wake button (1) outline will illuminate. Once activated, the temperature zone selection (2), temperature adjustment (7), temperature readout (8) and settings (15) menu icons will illuminate.

**Selecting a Temperature Zone**

Perlick’s touch-screen controller is preset with recommended temperature settings for white wine, red wine and cellaring. Within the presets, you have the ability to adjust the temperature in 1° increments as you desire. Because single zone models (CR24W) are one temperature throughout, there is no zone selection. On dual zone models (CR24D), press the temperature zone selection (2) icon to toggle through the zones until desired zone is illuminated. Single zone models come factory set to 50°F. Dual zone models come factory set to 60°F in the top zone and 50°F in the bottom zone.

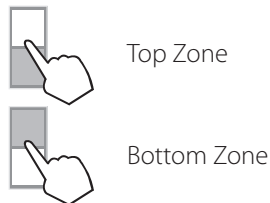

**TOUCH-SCREEN CONTROL OPERATION - WINE MODELS**

**Storing White Wine**

Perlick wine columns are preset with expert-recommended temperature settings for white wine. To set a zone in dual zone models to this preset, touch the temperature zone selection icon (2) to illuminate the zone you'd like to set to white wine temperature, then choose the white wine temperature setting icon (3) to set. For single zone models, simply choose the white wine temperature setting icon (3).

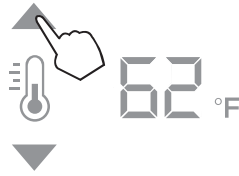

To adjust the temperature up or down, press the temperature adjustment (6) arrows until desired temperature is reflected in the temperature readout (7). Double beep indicates that minimum or maximum temperature has been reached. Temperature will flash twice to indicate new setting.

Compartment	Sp.	Factory Setting	Temperature Range
<b>Lower</b>		<b>50°F</b>	<b>40°F - 68°F</b>

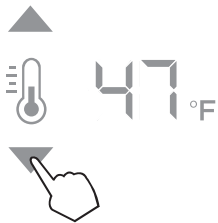

To adjust the temperature up or down, press the temperature adjustment (6) arrows until desired temperature is reflected in the temperature readout (7). Double beep indicates that minimum or maximum temperature has been reached. Temperature will flash twice to indicate new setting.

**Storing Red Wine**

Perlick wine columns are preset with expert-recommended temperature settings for red wine. To set a zone in dual zone models to this preset, touch the temperature zone selection icon (2) to illuminate the zone you'd like to set to red wine temperature, then choose the red wine temperature setting icon (4) to set. For single zone models, simply choose the red wine temperature setting icon (4).

Compartment	Sp.	Factory Setting	Temperature Range
<b>Top</b>		<b>60°F</b>	<b>40°F - 68°F</b>

**Cellaring Wine**

Perlick wine columns are preset with expert-recommended temperature settings for cellaring (long-term storage) wine. By choosing the cellar mode, the entire cabinet will default to 55°F for long-term storage. For dual zone models, touch the temperature zone selection icon (2) to illuminate, then choose the Cellar temperature setting icon (5) to set. For single zone models, simply choose the Cellar temperature icon (5).

Compartment	Sp.	Factory Setting	Temperature Range
<b>All</b>		<b>55°F</b>	<b>40°F - 68°F</b>

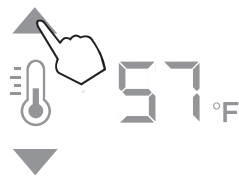

To adjust the temperature up or down, press the temperature adjustment (6) arrows until desired temperature is reflected in the temperature readout (7). Double beep indicates that minimum or maximum temperature has been reached. Temperature will flash twice to indicate new setting.

**TOUCH-SCREEN CONTROL OPERATION - WINE MODELS**

**Column Theatre Lighting**

Perlick column wine reserves feature an impressive amount of lighting for clear viewing and display of wine bottles. Door open white LED lighting runs vertically down the walls and horizontally across the ceiling of each compartment. Door closed (display) lighting can be changed from white to blue (blue will only illuminate the side walls.)

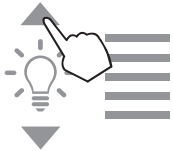

Wine models are factory set to white lighting. To adjust the brightness of the lighting when the door is opened, press the up and down arrows in the light intensity adjustment icon (4).



To change to blue lighting, continue pressing the arrows until the control turns blue in color (blue light only illuminates when the door is closed.)

To return to white lighting, continue pressing the arrows until controls illuminate white. Icons will flash twice to indicate new setting.



Lighting adjustments can be made separately for when the door is opened and closed. Select the light adjustment (door open) icon (8) to change the intensity of the light when the door is opened. Select the light adjustment (door closed) icon (9) to change the intensity or color of the light when the door is closed. Please note that when the door is open, the lights will automatically go back to white for visibility.

**Changing from Fahrenheit to Celsius scale**

The controller is factory set to Fahrenheit scale, but can easily be changed to read Celsius in the settings menu.



Press the settings menu (15) icon on the far right. This will illuminate a cluster of four icons as shown to the left. To display temperatures in Celsius, press the Celsius readout icon (12).



Change will be reflected in the temperature readout (7). The C will be illuminated to signify the scale.

**Quick Cool (Shopping) Mode**

The wine column can be set to Quick Cool (shopping) mode to lower the temperature after loading a large quantity of product to quickly bring them to the preferred temperature.

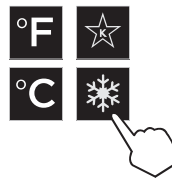

Press the settings menu (15) icon on the far right. This will illuminate a cluster of four icons as shown to the left. To activate Quick Cool (shopping) mode, press the Quick Cool (14) icon. This will activate the mode and the Quick Cool (14) will remain illuminated until the set point is achieved.

**TOUCH-SCREEN CONTROL OPERATION - WINE**

**FREEZER AMBIENT CONDITIONS**

**Showroom Mode**

Select Showroom mode for units that are being used solely for display purposes. Showroom mode has the user interface fully functional along with the cabinet lights, however, no compressor, evaporator fans or condenser fans will operate.

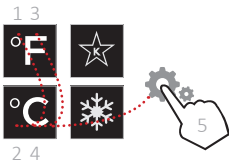

Press the settings menu (15) icon on the far right. This will illuminate a cluster of four icons as shown to the left. A 5 key combination\*, including the Fahrenheit readout (11) icon, Celsius readout (12) icon and settings menu (15) icon, will activate Showroom mode: F-C-F-C-Settings. Upon activating showroom mode, the temperature readout (7) will show Sh each time the door is opened until showroom mode is turned off.



To exit showroom mode, enter the 5 key combination.

*\*5 key combination must be completed within 5 seconds to turn showroom mode on and off.*

**Ambient Conditions**

For units installed in areas with changing ambient conditions, please take note of the table below. In extreme conditions that exceed those listed below, condensation may start to form on the front face of the cabinet.

Condensation will subside as conditions return to levels below those shown in the table.

Ambient (F°)	Relative Humidity (%)
<b>70°</b>	<b>80%</b>
<b>80°</b>	<b>78%</b>
<b>90°</b>	<b>75%</b>

**SURFACE CARE AND CLEANING**

**STAINLESS STEEL CARE AND CLEANING**

Stainless steel is a “passive” metal because it contains other metals like Chromium, Nickel and Manganese that stabilize the atoms. Chromium provides an invisible film that covers the steel surface, acting as a shield agent against corrosion. As long as the film is intact and not contaminated, the metal is passive and stainless. If the passive film of stainless steel has been broken, the surface can start to corrode or rust.

Three materials or processes can break down stainless steel’s passive layer, allowing corrosion to occur.

- **Mechanical Abrasion** This refers to items that will scratch stainless steel surfaces. Steel pads, wire brushes and scrapers are prime examples.
- **Water** Water that comes out of the faucet in varying degrees of hardness. Hard water may leave spots. When allowed to sit, these deposits will break down the passive Chromium layer and rust stainless steel. Other deposits from food preparation must be promptly removed with an appropriate cleaning agent.
- **Chlorides** Chlorides are found everywhere. They are in water, food and table salt. Household and industrial cleaners are the worst offenders.

**Preventing Stainless Steel Rust**

Use non-abrasive tools to clean stainless steel surfaces. Soft cloths and plastic scouring pads will not harm the steel’s passive layer.

Clean with polish lines. Some stainless steels have visible polishing lines or “grain”. When visible lines are present, always scrub in a motion parallel to the lines. When the grain cannot be seen, polish in a consistent straight pattern- not in a circular motion.

Use alkaline, alkaline chlorinated or non-chloride containing cleaners. While many traditional cleaners are loaded with chlorides, the industry is providing an ever-increasing choice of non-chloride cleaners. If you are not sure of chloride content in the cleaner being used, contact your cleaner supplier. If your present cleaner contains chloride, ask your supplier for an alternative. Avoid cleaners containing quaternary salt; it also can attack stainless steel and cause pitting and/or rusting. Clean

frequently to avoid build-up of hard, stubborn stains.

**Stainless Steel Exterior Door Cleaning**

Keep exterior stainless steel surface pristine by wiping the door with a damp microfiber cloth, followed by a dry polishing chamois. Always follow the grain direction when cleaning.

**SLATE METALLIC SURFACE CARE AND CLEANING**

Perlick’s slate metallic surface is finished with powder coat. When properly cared for, powder coating provides a durable, uniform finish that is resistant to scuffing, scratching and staining.

The following surfaces are slate metallic (see yellow outlines below for locations):

- **Refrigerator Models** Drawers, Tip Out Bin, Door Bins
- **Freezer Models** Drawer Bins, Door Bins
- **Wine Models** Wine Shelf Fronts

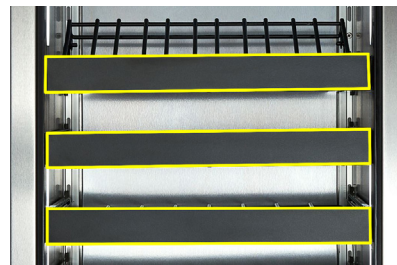

To clean the slate metallic surface:

1. Carefully remove any loose debris with a damp sponge.
2. Use a soft cloth and a mild household detergent solution to remove deposits.
3. Wipe area with soft cloth and clean water. Dry thoroughly.

**ADJUSTING THE WINE SHELVES**

**WINE SHELVING**

Prior to making shelf adjustments, clear the shelf of product. Shelf must be empty prior to changing its position.

**TO REMOVE WINE SHELVES**

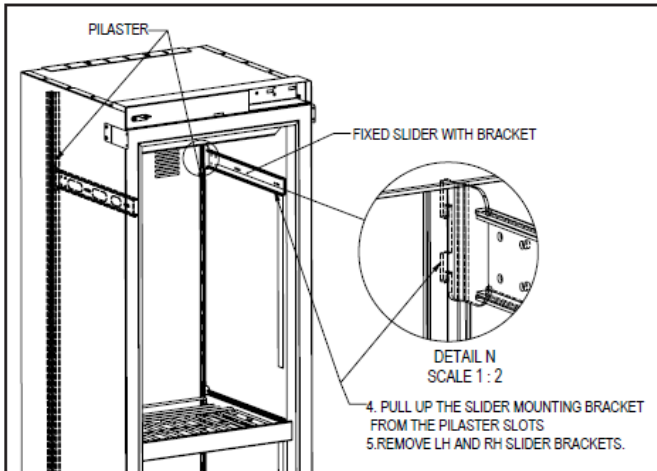
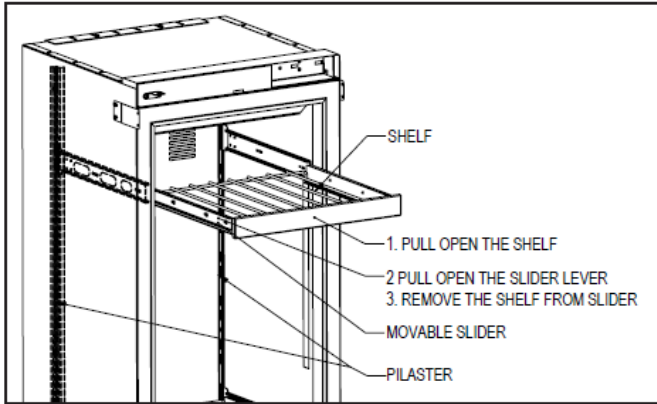

**TO INSTALL WINE SHELVES**

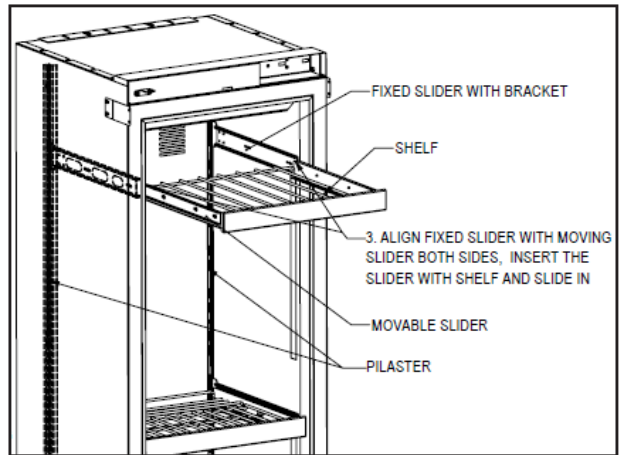
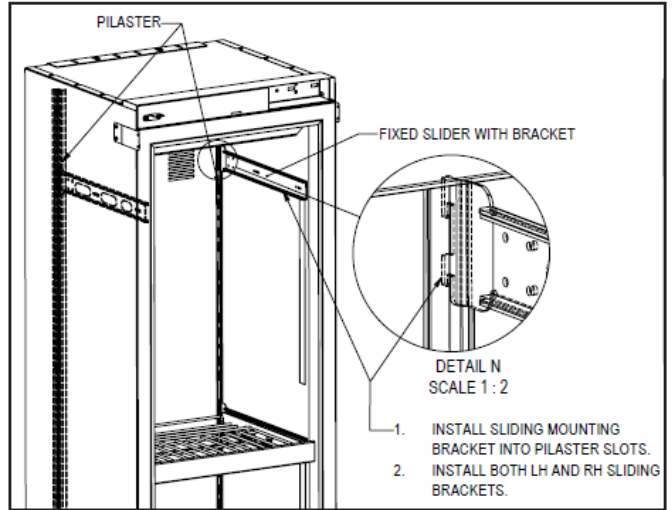

**INSTALLING FILTERS**

**CARBON AIR FILTERS**

Carbon air filters should be placed in the holder in the perforated panel located in the top-rear of the cabinet (A).

**NOTE:** When installing carbon air filter in wine units, the top rack will need to be removed to access the perforated panel.

1. Remove the filter from the plastic bag before installing into the unit. Take care not to open or puncture the tyvek bag in the casing.
2. Pull firmly to lower the carbon air filter panel.
3. Place the carbon air filter into the holder directly onto the panel and close panel- push firmly to engage closure clips.
4. It is recommended to replace the carbon air filter every 3-6 months.

**ETHYLENE FILTERS**

Ethylene filters should be placed in the holder in top of the tip-out produce bin (B).

1. Remove the filter from the plastic bag before installing into the unit. Take care not to open or puncture the tyvek bag in the casing.
2. Open the tip-out bin to access filter housing located on the top of the bin.
3. Slide filter into housing and close tip-out bin.
4. It is recommended to replace the ethylene filter every 3 months.

Need to order replacement filters? Contact your selling dealer or visit [perlick.com/residential](http://perlick.com/residential) to find a Perlick dealer near you.

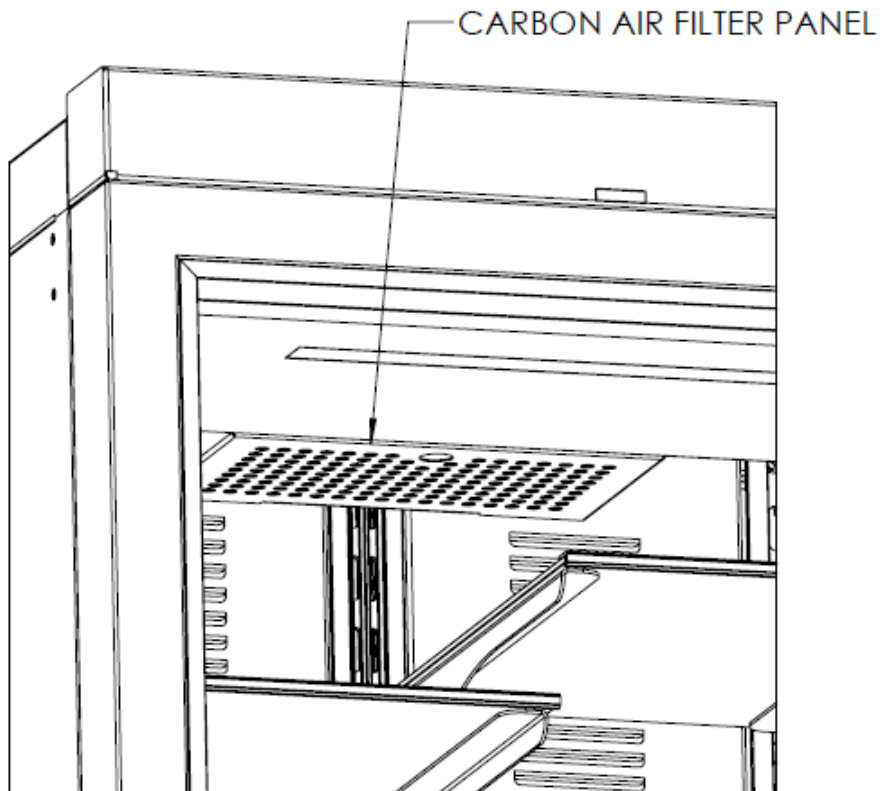
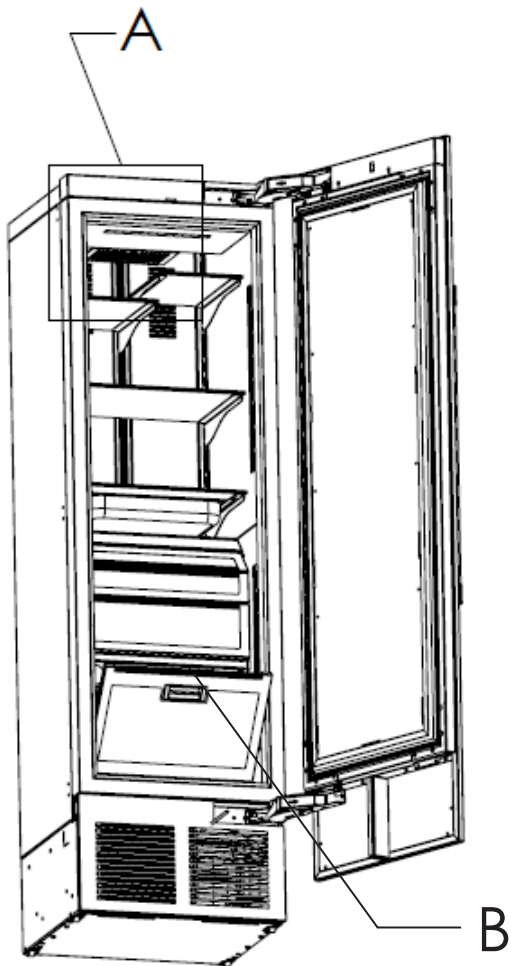

**DETAIL A**  
**SCALE 1 : 4**



**TROUBLESHOOTING**

If the unit appears to be malfunctioning, check the troubleshooting guide below to see if you can identify the cause and remedy for the issue and resolve it without a service call.

Problem	Cause	Solution
UI flashes 5h	Cabinet is in Showroom Mode	Press the settings menu icon (⚙️) to illuminate a cluster of four icons. A five key combination- F-C-F-C-Settings- will exit showroom mode as shown below: 
Door alarm is beeping	Door has been open for more than 3 minutes	Close the door
Light stays on when door is closed (wine units)	Door Closed with Light (Display)	Follow directions above to turn off Door Closed with Light (Display) mode.
Light stays on when door is closed (all units)	Door not closing correctly	Determine what may be causing the door to not fully close
	Issue with reed switch and magnet	Contact Perlick Technical Service at (844) 411-8050
Compartments are warmer than usual	Control is preset too warm	Lower the setpoint temperature. Refer to changing the set point for the specific model in this manual
	Condenser is dirty or obstructed	Clear the condenser and clear obstruction
	The door is open or has been opened more frequently lately	Wait 24 hours and recheck the temperature
	Internal louvers and/or damper covers are obstructed	Reset the preset temperature if necessary- refer to page 4-13 of this manual for settings  Make sure the louvers and/or the fan are not obstructed
	Warm product was recently placed in the cabinet	Engage QuickCool mode; see pages 4-13 for instructions for instructions on how
System runs for a long period of time	Condenser is dirty or obstructed	Clean the condenser and clear the obstruction
	Door was kept open for a long time or was opened more frequently, or warm product was recently placed in the cabinet	Wait 24 hours and recheck temperature
	Hot day and warm room temperature	Normal for the system to run more frequently
Condensation forms outside of the unit	High humidity and/or frequent door opening	Normal operation ( <i>See page 13 for ambient conditions for CR24F Freezer models</i> )

**TROUBLESHOOTING**

Condensation forms inside the compartments	Door is not closing and sealing properly	Make sure the door is closing properly. Check the door deal and replace if necessary  If condensation persists, contact Perlick Technical Service at (844) 411-8050
Noisy operation	Soft sounds from compressor, fan motor and valves heard	Normal operation
	“Crackling” sounds during defrost	Normal operation
Unit is not running	No power going to the unit	Home circuit breaker was tripped. Reset the circuit breaker  Ensure the unit is plugged in  Ensure the unit is not in “Showroom” mode

Below is a list of column troubleshoot codes. If the cause occurs, the corresponding code will flash on the PerliQ™ touch-screen control. See the Solution column on the far right for the corrective action.

Code	Cause	Solution
P1, P2, P3, P4, P5, P6	Temperature or humidity sensor failure	Call Perlick Technical Service at (844) 411-8050
L1, L2, L3, L4, L5, L6	Low temperature alarm	High and Low temperature alarms may occur from extended door openings or heavy loading of warm product. If alarm persists, call Perlick Technical Service at (844) 411-8050
H1, H2, H3, H4, H5, H6	High temperature alarm	
r5, r6	Open/Disconnected humidity sensor	Call Perlick Technical Service at (844) 411-8050
d1	Door open alarm	Close the door

## WARRANTY

## PERLICK CORPORATION

## RESIDENTIAL REFRIGERATION PRODUCTS LIMITED WARRANTY

## WARRANTY:

Perlick Corporation (“Perlick”) warrants to the original retail purchaser that during the Basic Warranty Period, Perlick’s products will be free from defects in material and workmanship, and during the Extended Warranty Period, the hermetically sealed refrigeration system contained in Perlick’s undercounter or upright refrigerators will be free from defects in material and workmanship. This system consists entirely of the compressor, condenser, drier, connecting tubing, evaporator and hot gas bypass valve.

**The Basic Warranty Period is as follows:**

- For a new product or a floor display model sold within three (3) years of being put on the floor, in each case other than the H50IM Clear Ice Maker: The three (3) year period commencing on the date of purchase by the original retail purchaser, except that the Basic Warranty Period will be the two (2) year period commencing on the date of purchase by the original retail purchaser if the purchase of the product is not registered with Perlick within ninety (90) days of purchase in the manner described below.
- For the H50IM Clear Ice Maker, a floor display model (other than of the H50IM Clear Ice Maker) sold more than three (3) years but less than six years after being put on the floor or a factory second (B-Stock) product: The one (1) year period commencing on the date of purchase by the original retail purchaser.
- For a floor display model of the H50IM Clear Ice Maker sold more than three (3) years but less than six years after being put on the floor: The ninety (90) day period commencing on the date of purchase by the original retail purchaser.

The Extended Warranty Period applies only to the hermetically sealed refrigeration system contained in Perlick’s undercounter and upright refrigerators. For undercounter refrigerators, the Extended Warranty Period is the portion of the six (6) year period commencing on the date of purchase by the original retail purchaser that is not covered by the Basic Warranty

Period. For upright refrigerators, the Extended Warranty Period is the portion of the twelve (12) year period commencing on the date of purchase by the original retail purchaser that is not covered by the Basic Warranty Period.

For a floor display model sold six years or more after being put on the floor, there is no warranty and such product is sold on an “as is” basis.

**REMEDY:**

Perlick will provide the parts and labor necessary to repair or replace (at Perlick’s option) any parts proven to be defective in material or workmanship during the Basic Warranty Period. Perlick will provide the replacement parts, but not the labor, for any parts of the hermetically sealed refrigeration system proven to be defective in materials or workmanship during the Extended Warranty Period. The cost of freight to ship the replacement parts will be paid by Perlick. Replacement parts are warranted for the remainder of the original warranty period, or ninety (90) days, whichever is longer.

**REGISTRATION:**

Your Perlick product can be registered at [www.perlick.com/RegisterMyPerlick](http://www.perlick.com/RegisterMyPerlick).

**OTHER TERMS AND CONDITIONS:**

This Warranty applies only to products installed in the fifty states of the United States, the District of Columbia and the ten provinces of Canada.

To obtain the warranty coverage described in this Warranty, Perlick or its authorized distributor or dealer must receive written notice of the warranty claim within the applicable warranty period. To receive parts and/or service and the name and telephone number of the nearest Perlick authorized service representative, please contact your Perlick dealer or distributor, or Perlick’s Customer Service Department by writing to it at Perlick Corporation, Attn: Customer Service Department, 8300 West Good Hope Road, Milwaukee, Wisconsin 53223; or by calling Perlick’s Customer Service Department at 800-558-5592; or by e-mailing Perlick’s Customer Service

Department at [warranty@perlick.com](mailto:warranty@perlick.com). In addition, you can notify Perlick of a warranty claim by submitting the form on the Perlick website at [www.perlick.com/residential/contact](http://www.perlick.com/residential/contact) and choosing 'Service' from the department list.

All service provided by Perlick under this Warranty must be performed by Perlick's authorized service representatives, unless otherwise specified by Perlick in writing. Service will be provided during normal business hours.

This Warranty applies only to the original retail purchaser of the Perlick product, and may not be assigned or transferred.

This Warranty does not apply to:

- Damage to Products occurring during transportation.
- Products that are used in a manner that is not normal residential or light commercial use.
- Products that are: improperly installed; misused or abused; operated with low voltage; wired in a manner not conforming to electrical codes; not properly operated in accordance with Perlick's instructions; not cleaned or maintained in accordance with Perlick's instructions; modified; or damaged by lightning or other acts of nature.
- Consumable items such as light bulbs.
- Cosmetic damage.
- Adjustments to controls, door reversal, cleaning the condenser or other routine maintenance.
- Products for which the original proof of purchase, delivery date or serial number cannot be verified.
- Products for which the defective parts are not returned for inspection if requested by Perlick.
- Damage to other property caused by the products, including but not limited to loss of food due to spoilage and damage caused by water leakage.

THIS LIMITED WARRANTY IS IN LIEU OF ANY OTHER WARRANTY, EXPRESSED OR IMPLIED, INCLUDING BUT NOT LIMITED TO ANY IMPLIED WARRANTY OF MERCHANTABILITY OR FITNESS FOR A PARTICULAR PURPOSE; PROVIDED HOWEVER, THAT TO THE EXTENT REQUIRED BY LAW, IMPLIED WARRANTIES ARE INCLUDED BUT DO NOT EXTEND BEYOND THE DURATION OF THE EXPRESS WARRANTY FIRST SET ABOVE.

PERLICK'S SOLE LIABILITY AND YOUR EXCLUSIVE REMEDY UNDER THIS WARRANTY ARE SET FORTH IN THE PARAGRAPH ENTITLED "REMEDY" SET FORTH ABOVE.

PERLICK SHALL HAVE NO LIABILITY WHATSOEVER FOR ANY INCIDENTAL, CONSEQUENTIAL OR SPECIAL DAMAGES ARISING FROM THE SALE, USE OR INSTALLATION OF THE PRODUCT OR FROM ANY OTHER CAUSES WHATSOEVER, WHETHER BASED ON WARRANTY (EXPRESS OR IMPLIED) OR OTHERWISE BASED ON CONTRACT, TORT OR ANY OTHER THEORY OF LIABILITY. IN NO EVENT SHALL PERLICK'S LIABILITY WITH RESPECT TO A PRODUCT EXCEED THE PURCHASE PRICE OF THE PRODUCT.

Some states do not allow limitations on how long an implied warranty lasts, or the exclusion or limitation of incidental or consequential damages, so the above limitations and exclusions may not apply to you. This Warranty gives you specific legal rights, and you may also have other rights, which vary from state to state.

## CONTACT US

**For Product Information**

- Contact your selling dealer
- Inquire via the web at [perlick.com/residential](http://perlick.com/residential)
- Call (800) 558-5592 for factory assistance on planning installation or product information
- Write to Perlick Corporation, Residential Customer Service, 8300 W. Good Hope Rd., Milwaukee, WI 53223, USA
- Email us at [residentialsales@perlick.com](mailto:residentialsales@perlick.com)

**For Product Service**

- Prior to contacting Perlick, check the identification plate (see page 2 for location) for the serial number on the cabinet you are calling about.
- Visit [perlick.com/residential/contact](http://perlick.com/residential/contact) and live chat with Perlick Technical Service 7am-6pm Monday-Friday. Look for the graphic below and click to chat with an agent

**POST-SALES SUPPORT:**
 LIVE CHAT (Powered by Parts Town)

- Visit [perlick.com/residential/contact](http://perlick.com/residential/contact) and fill out the Contact form. Select 'Service' from Choose a Department and note the serial number of the cabinet you are writing about in the Question or Comment section.
- Call (844) 411-8050 to speak with a Perlick Technical Service agent
- Email us at [servicedept@perlick.com](mailto:servicedept@perlick.com)

**For Replacement Parts**

- Use only genuine Perlick replacement parts and accessories. Genuine Perlick parts and accessories are designed to work correctly with Perlick products and offer superior service life. The use of non-Perlick parts can damage the unit and may void the warranty.
- Prior to contacting Perlick, check the identification plate (see page 2 for location) for the serial number on the cabinet you are calling about.
- Visit [perlick.com/residential/contact](http://perlick.com/residential/contact) and live chat with Perlick Technical Service 7am-6pm Monday-Friday. Look for the graphic below and click to chat with an agent

**POST-SALES SUPPORT:**
 LIVE CHAT (Powered by Parts Town)

- Visit [perlick.com/residential/contact](http://perlick.com/residential/contact) and fill out the Contact form. Select 'Service' from Choose a Department and note the serial number of the cabinet you are writing about in the Question or Comment section.
- Call (844) 411-8050 to speak with a Perlick Technical Service agent
- Email us at [servicedept@perlick.com](mailto:servicedept@perlick.com)



# Perlick®

Perlick Residential is a division of Perlick Corporation

© 2017 Perlick Corporation

8300 West Good Hope Road, Milwaukee, WI 53223, USA

[perlick.com/residential](http://perlick.com/residential) • (800) 558-5592

FORM NO. Z2497  
REV. D-09/13/2018