



**INSTRUCTIONS D'ASSEMBLAGE
ASSEMBLY INSTRUCTIONS**

MONARCH
SPECIALTIES INC.

8P23406

**SOFA INCLINABLE -
MOTORISER / USB TISSU BEIGE SKY #2514-06**

**RECLINING SOFA -
POWER / USB - BEIGE FABRIC SKY #2514-06**





**POUR DE L'ASSISTANCE OU POUR COMMANDER
DES PIÈCES CONTACTEZ NOTRE DÉPARTEMENT
DE SERVICE À LA CLIENTÈLE.**

**FOR ASSISTANCE OR TO ORDER PARTS
CONTACT OUR CUSTOMER SERVICE DEPARTMENT**

WWW.MONARCHSERVICE.COM

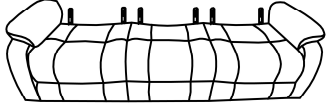
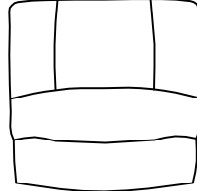
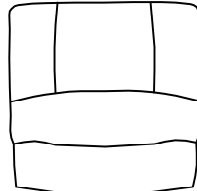
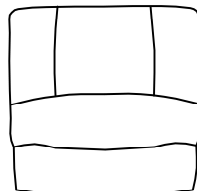
LISTE DES PIÈCES
PARTS LIST

| PIÈCE / PART # | IMAGE | DESCRIPTION | QTY / QTÉ |
|----------------|---|---|-----------|
| 1 |  | SEAT SIÈGE | 1 |
| 2 |  | BACK REST DOSSIER | 1 |
| 3 |  | BACK REST DOSSIER | 1 |
| 4 |  | BACK REST DOSSIER | 1 |
| 5 |  | FRONT FACING LEFT SIDE WING AILETTE AVANT GAUCHE | 1 |

LISTE DES PIÈCES
PARTS LIST

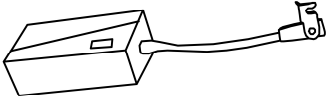
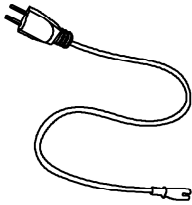
| PIÈCE / PART # | IMAGE | DESCRIPTION | QTY / QTÉ |
|----------------|---|--|-----------|
| 6 |  | <p>FRONT FACING RIGHT SIDE WING AILETTE AVANT DROITE</p> | 1 |
| 7 |  | <p>AC/DC ADAPTOR ADAPTEUR AC/DC</p> | 1 |
| 8 |  | <p>PLUG PRISE DE COURANT</p> | 1 |

ÉTAPE / STEP 1

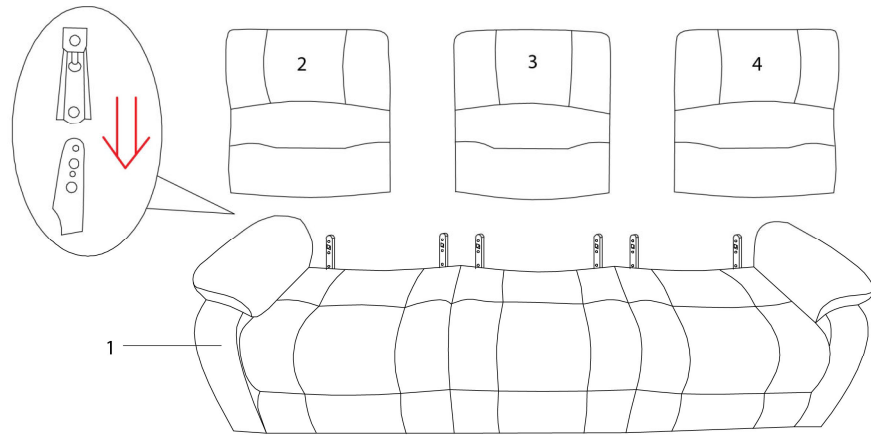

VOUS DEVEZ ENLIGNER LES DEUX GLISSOIRS DU DOSSIER AVEC LES DEUX TIGES DU SIÈGE EN MÊME TEMPS ET POUSSER VERS LE BAS POUR LES ENCLENCHER.

ALIGN THE TWO BACKREST BRACKETS WITH THE TWO SEAT HOOKS AND PUSH DOWN TO HOOK TOGETHER.

ÉTAPE / STEP 2

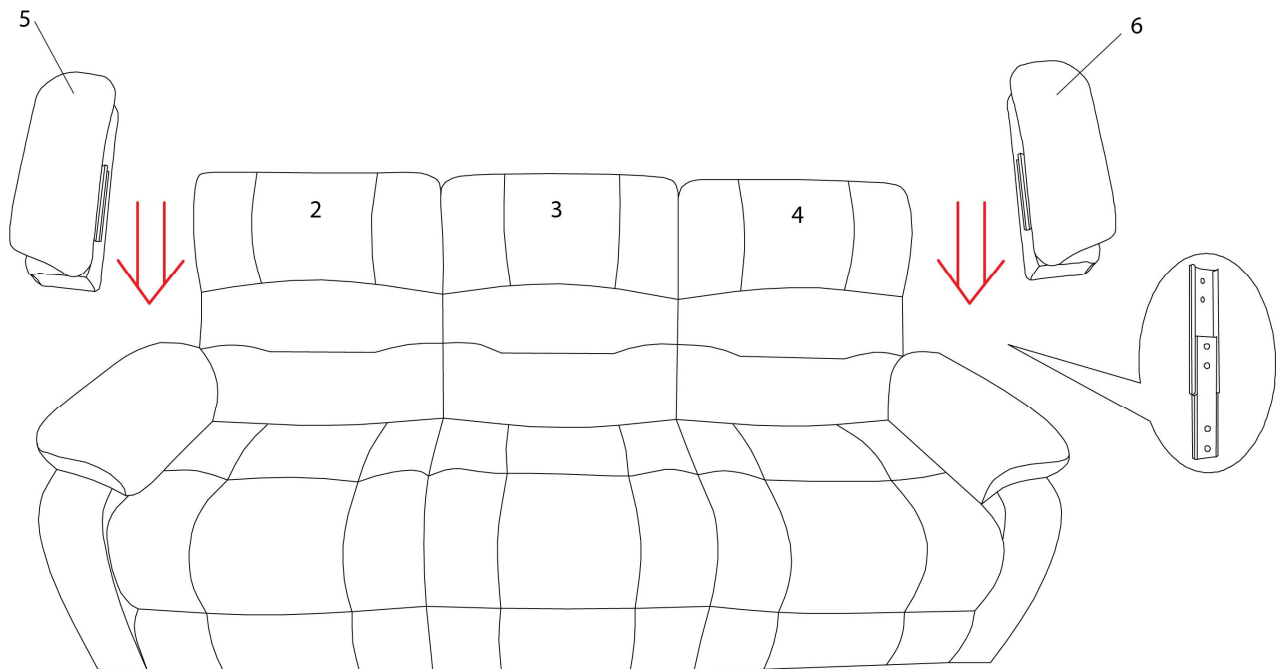

ÉTAPE / STEP 3

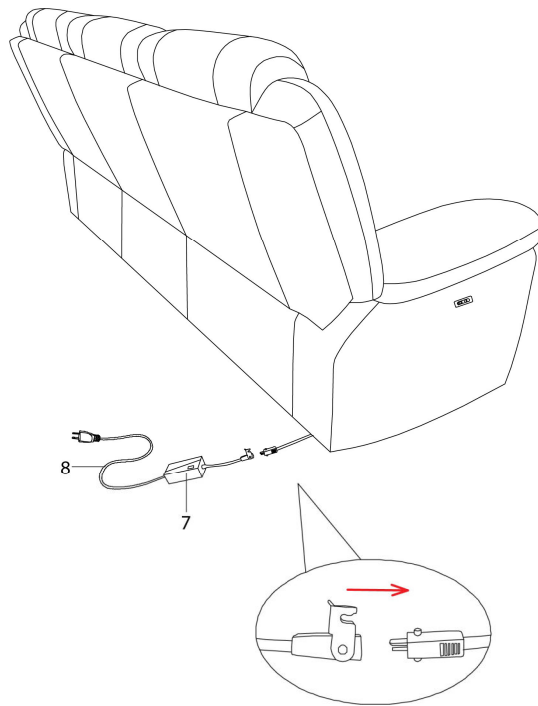

ÉTAPE / STEP 4

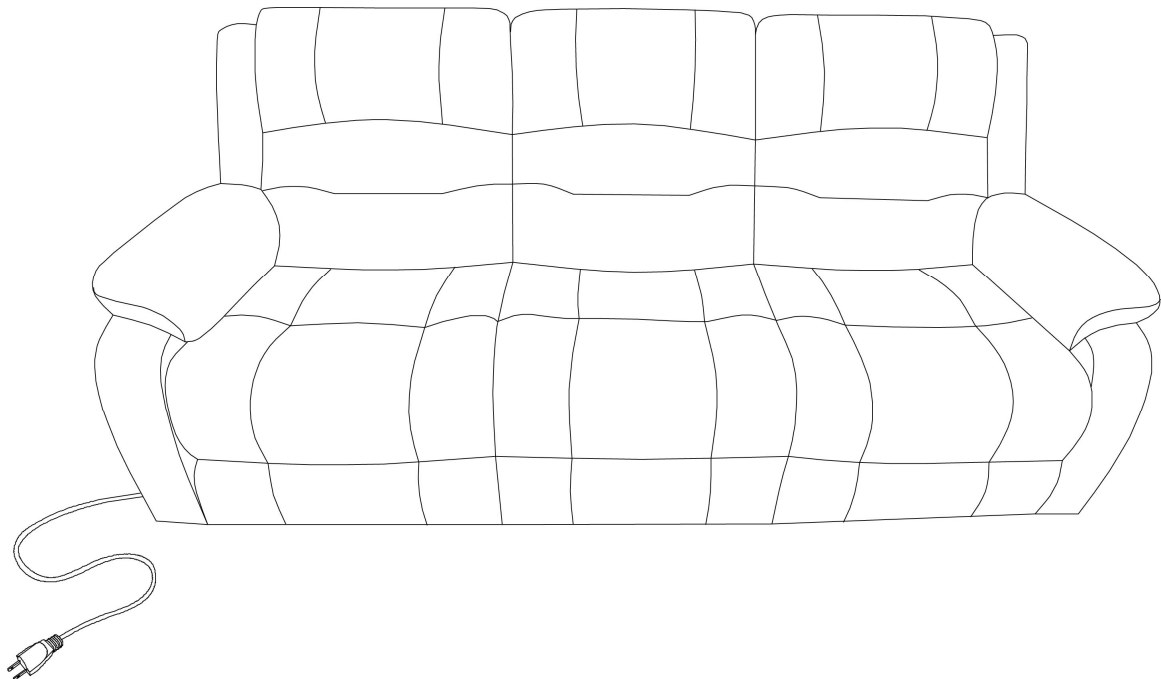

ÉTAPE / STEP 5

