

# ASSEMBLY INSTRUCTIONS









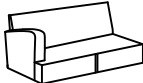

## Item #:U4551-11-03 LSF LOVESEAT

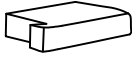
Thank you for purchasing this quality product .Be sure to check all packing materials carefully for small parts that may have come loose inside the carton during shipment.

**Before you Assemble:** Please read all instruction carefully before beginning the assembly process. It is recommended that 2 people work together during assembly to prevent personal injury and to ensure that heavy or cumbersome parts are not damaged during the process.

**CAUTION:**For your safety,this product requires two people to lift.

### PARTS LIST

A	LSF LOVESEAT SOFA BASE		1PC
B	LSF BACK CUSHION		1PC
C	RSF BACK CUSHION		1PC
D	LSF SEAT CUSHION		1PC
E	RSF SEAT CUSHION		1PC
F	PILLOW 20"*20"		1PC
G	PILLOW 20"*20"		1PC
H	PILLOW 20"*20"		1PC
I	PLASTIC LEGS		4PC
J	FLAT WASHER		8PC
K	BOLT		8PC
L	WRENCH		1PC

Need Assistance? Call us at 1-855-343-7378 from 8:00am to 5:00pm PST Monday-Friday

**STEP 1** Attach leg to bottom of LSF LOVESEAT with BOLT(K), WASHER,(J)and WRENCH(L).

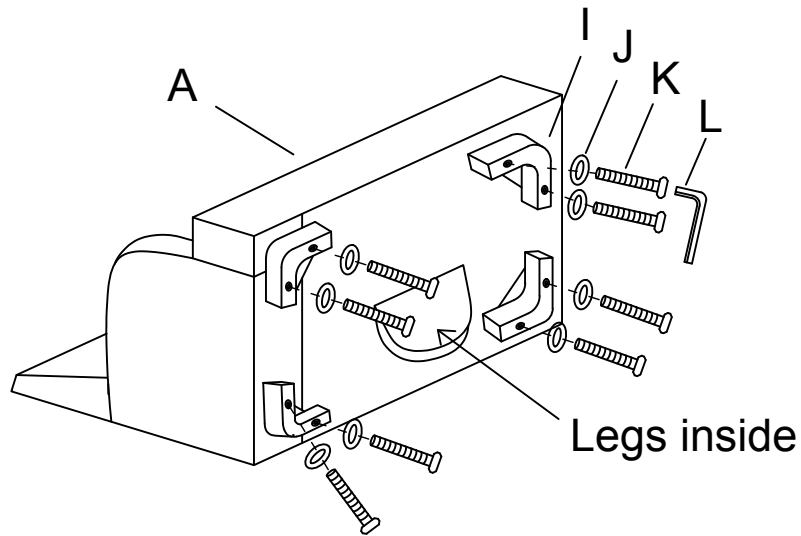

**STEP 2** ASSEMBLY COMPLETE

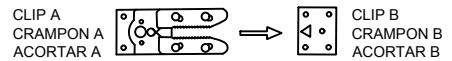
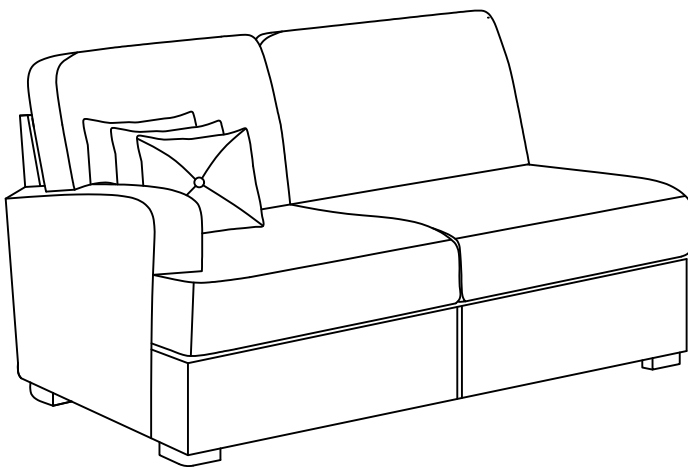

Connect corresponding male and female metal connectors at the bottom of the base.

# ASSEMBLY INSTRUCTIONS







## Item #:U4551-15-03 ARMLESS CHAIR

Thank you for purchasing this quality product .Be sure to check all packing materials carefully for small parts that may have come loose inside the carton during shipment.

**Before you Assemble:** Please read all instruction carefully before beginning the assembly process. It is recommended that 2 people work together during assembly to prevent personal injury and to ensure that heavy or cumbersome parts are not damaged during the process.

**CAUTION:**For your safety,this product requires two people to lift.

### PARTS LIST

A	ARMLESS CHAIR SOFA BASE		1PC
B	BACK CUSHION		1PC
C	SEAT CUSHION		1PC
D	PLASTIC LEGS		4PC
E	FLAT WASHER		8PC
F	BOLT		8PC
G	WRENCH		1PC

**STEP 1** Attach leg to bottom of ARMLESS CHAIR with BOLT(F), WASHER,(E)and WRENCH(G).

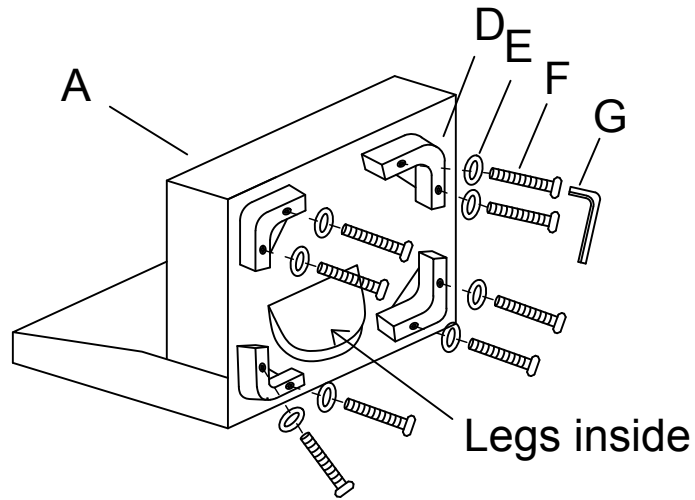

**STEP 2** ASSEMBLY COMPLETE

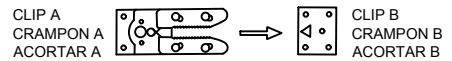
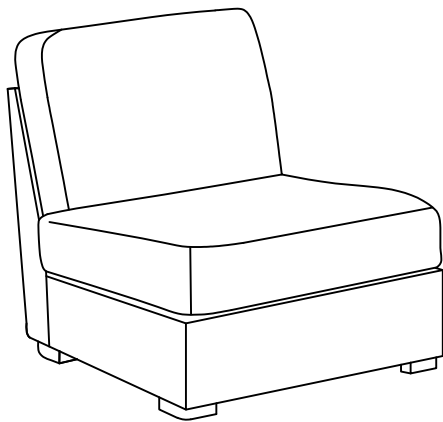

Connect corresponding male and female metal connectors at the bottom of the base.

# ASSEMBLY INSTRUCTIONS









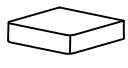

## Item #:U4551-14-03 CORNER CHAIR

Thank you for purchasing this quality product .Be sure to check all packing materials carefully for small parts that may have come loose inside the carton during shipment.

**Before you Assemble:** Please read all instruction carefully before beginning the assembly process. It is recommended that 2 people work together during assembly to prevent personal injury and to ensure that heavy or cumbersome parts are not damaged during the process.

**CAUTION:**For your safety,this product requires two people to lift.

### PARTS LIST

A	CORNER CHAIR SOFA BASE		1PC
B	LSF BACK CUSHION		1PC
C	RSF BACK CUSHION		1PC
D	SEAT CUSHION		1PC
E	PILLOW 20"*20"		1PC
F	PILLOW 20"*20"		1PC
G	PILLOW 20"*20"		1PC
H	PLASTIC LEGS		4PC
I	FLAT WASHER		8PC
J	BOLT		8PC
K	WRENCH		1PC

**STEP 1** Attach leg to bottom of CORNER CHAIR with BOLT(J), WASHER,(I)and WRENCH(K).

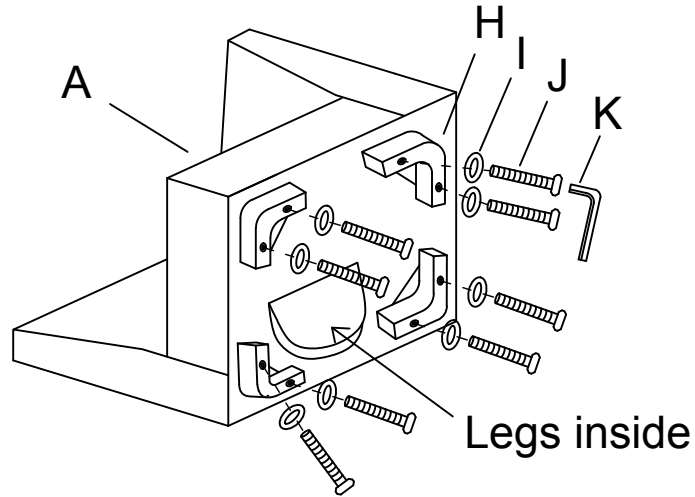

**STEP 2** ASSEMBLY COMPLETE

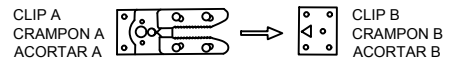
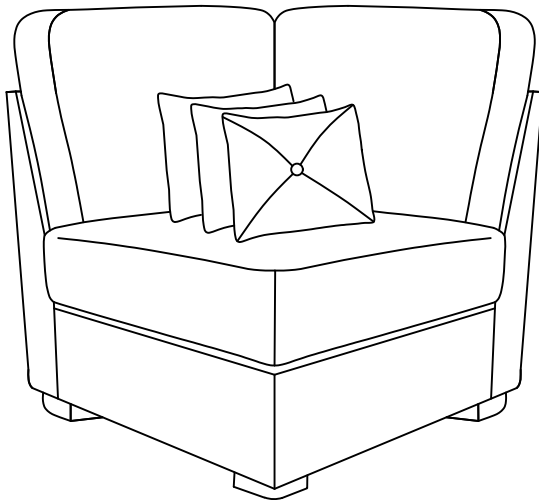

Connect corresponding male and female metal connectors at the bottom of the base.

# ASSEMBLY INSTRUCTIONS







Item #:U4551-16-03 ARMLESS LOVESEAT

Thank you for purchasing this quality product .Be sure to check all packing materials carefully for small parts that may have come loose inside the carton during shipment.

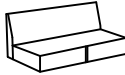
**Before you Assemble:** Please read all instruction carefully before beginning the assembly process. It is recommended that 2 people work together during assembly to prevent personal injury and to ensure that heavy or cumbersome parts are not damaged during the process.

**CAUTION:**For your safety,this product requires two people to lift.

## PARTS LIST

A	ARMLESS LOVESEAT SOFA BASE		1PC
B	BACK CUSHION		2PC
C	SEAT CUSHION		2PC
D	PLASTIC LEGS		4PC
E	FLAT WASHER		8PC
F	BOLT		8PC
G	WRENCH		1PC

**STEP 1** Attach leg to bottom of ARMLESS LOVESEAT with BOLT(F), WASHER,(E)and WRENCH(G).

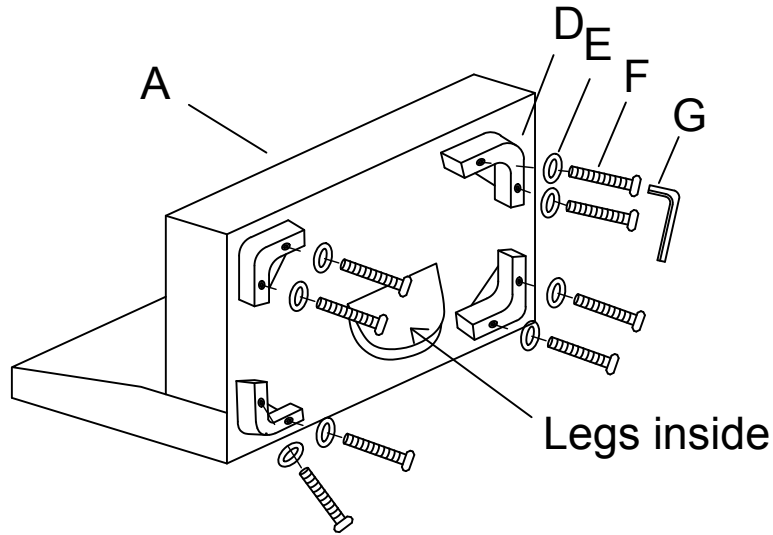

**STEP 2** ASSEMBLY COMPLETE

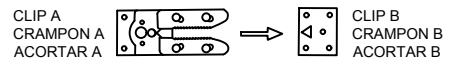
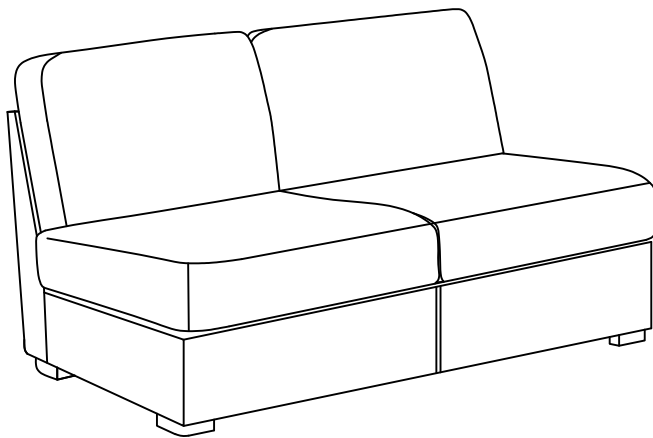

Connect corresponding male and female metal connectors at the bottom of the base.



# ASSEMBLY INSTRUCTIONS











## Item #:U4551-42-03 RSF CHAISE

Thank you for purchasing this quality product .Be sure to check all packing materials carefully for small parts that may have come loose inside the carton during shipment.

**Before you Assemble:** Please read all instruction carefully before beginning the assembly process. It is recommended that 2 people work together during assembly to prevent personal injury and to ensure that heavy or cumbersome parts are not damaged during the process.

**CAUTION:**For your safety,this product requires two people to lift.

### PARTS LIST

A	RSF CHAISE SOFA BASE		1PC
B	BACK CUSHION		1PC
C	SEAT CUSHION		1PC
D	PILLOW 20"*20"		1PC
E	PILLOW 20"*20"		1PC
F	PILLOW 20"*20"		1PC
G	PLASTIC LEGS		5PC
H	FLAT WASHER		10PC
I	BOLT		10PC
J	WRENCH		1PC

**STEP 1** Attach leg to bottom of RSF CHAISE with BOLT(I), WASHER,(H)and WRENCH(J).

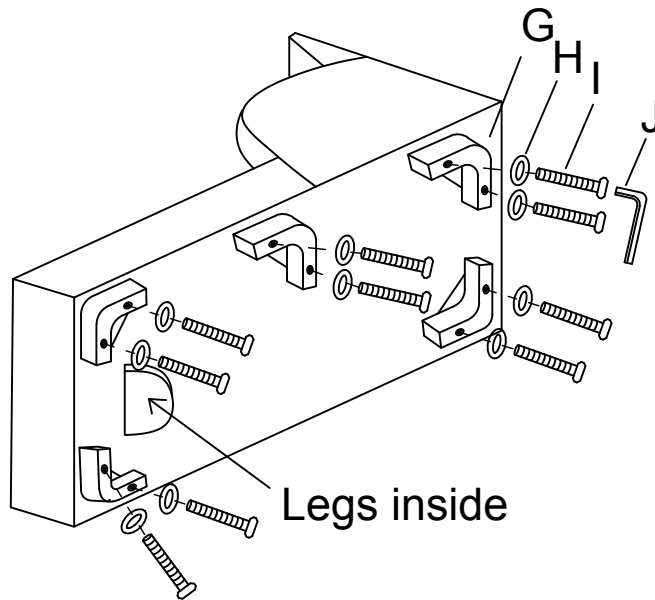

**STEP 2** ASSEMBLY COMPLETE

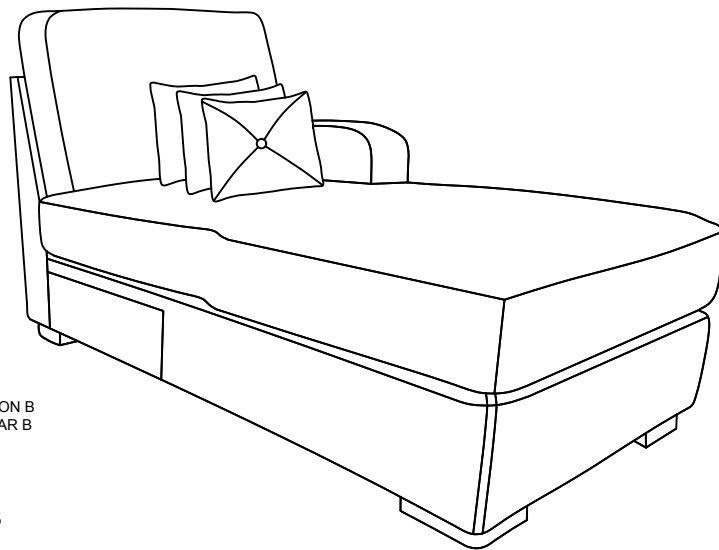

CLIP A  
CRAMPON A  
ACORTAR A

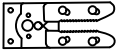

CLIP B  
CRAMPON B  
ACORTAR B

Connect corresponding male and female metal connectors at the bottom of the base.

# ASSEMBLY INSTRUCTIONS









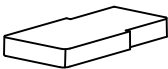

## Item #:U4551-41-03 LSF CHAISE

Thank you for purchasing this quality product .Be sure to check all packing materials carefully for small parts that may have come loose inside the carton during shipment.

**Before you Assemble:** Please read all instruction carefully before beginning the assembly process. It is recommended that 2 people work together during assembly to prevent personal injury and to ensure that heavy or cumbersome parts are not damaged during the process.

**CAUTION:**For your safety,this product requires two people to lift.

### PARTS LIST

A	LSF CHAISE SOFA BASE		1PC
B	BACK CUSHION		1PC
C	SEAT CUSHION		1PC
D	PILLOW 20"*20"		1PC
E	PILLOW 20"*20"		1PC
F	PILLOW 20"*20"		1PC
G	PLASTIC LEGS		5PC
H	FLAT WASHER		10PC
I	BOLT		10PC
J	WRENCH		1PC

**STEP 1** Attach leg to bottom of LSF CHAISE with BOLT(I), WASHER,(H)and WRENCH(J).

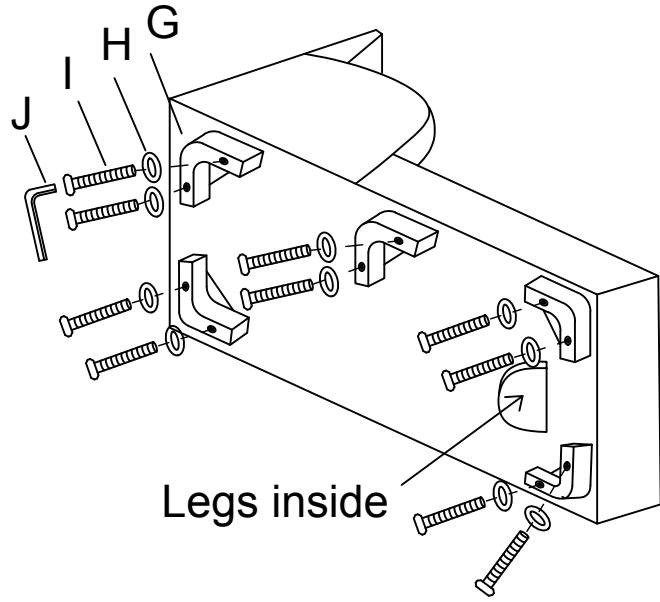

**STEP 2** ASSEMBLY COMPLETE

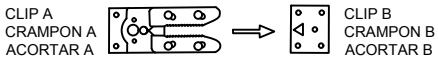
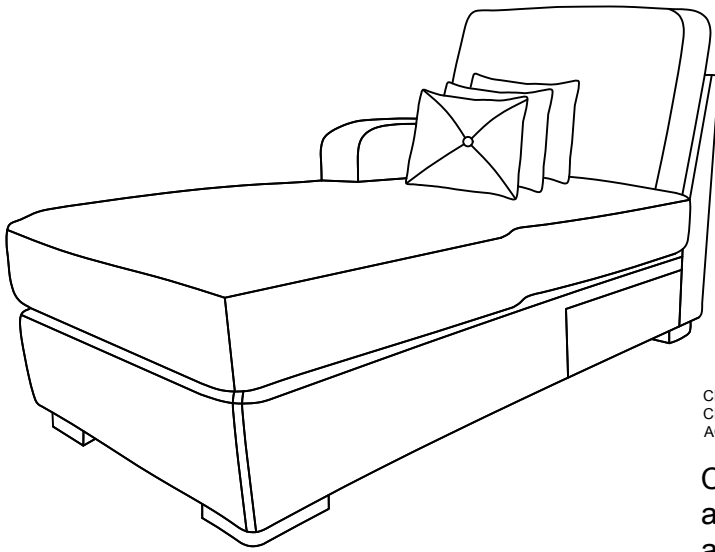

Connect corresponding male and female metal connectors at the bottom of the base.

# ASSEMBLY INSTRUCTIONS









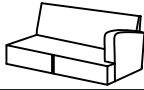

## Item #:U4551-12-03 RSF LOVESEAT

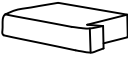
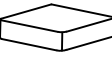
Thank you for purchasing this quality product .Be sure to check all packing materials carefully for small parts that may have come loose inside the carton during shipment.

**Before you Assemble:** Please read all instruction carefully before beginning the assembly process. It is recommended that 2 people work together during assembly to prevent personal injury and to ensure that heavy or cumbersome parts are not damaged during the process.

**CAUTION:**For your safety,this product requires two people to lift.

### PARTS LIST

A	RSF LOVESEAT SOFA BASE		1PC
B	RSF BACK CUSHION		1PC
C	LSF BACK CUSHION		1PC
D	RSF SEAT CUSHION		1PC
E	LSF SEAT CUSHION		1PC
F	PILLOW 20"*20"		1PC
G	PILLOW 20"*20"		1PC
H	PILLOW 20"*20"		1PC
I	PLASTIC LEGS		4PC
J	FLAT WASHER		8PC
K	BOLT		8PC
L	WRENCH		1PC

Need Assistance? Call us at 1-855-343-7378 from 8:00am to 5:00pm PST Monday-Friday

**STEP 1** Attach leg to bottom of RSF LOVESEAT with BOLT(K), WASHER,(J)and WRENCH(L).

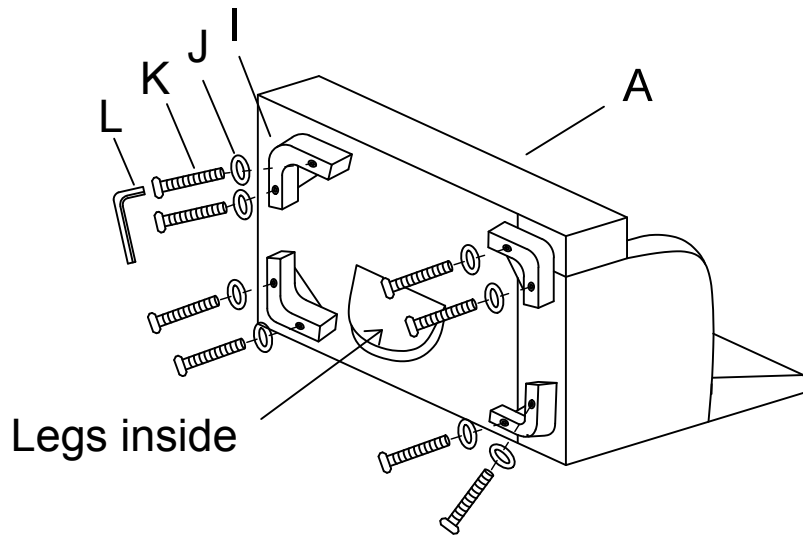

**STEP 2** ASSEMBLY COMPLETED!

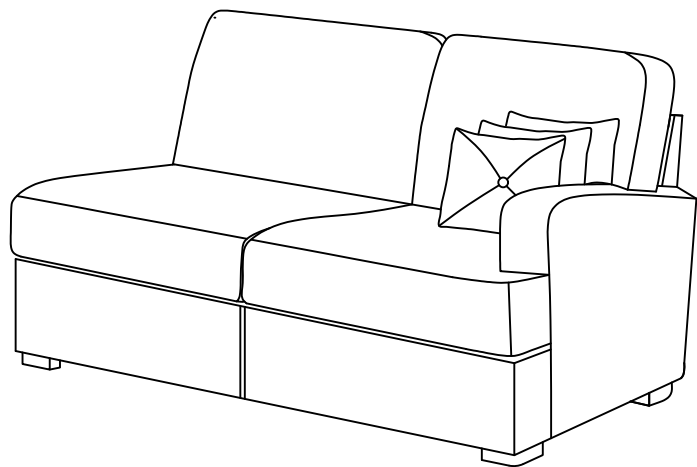

CLIP A  
CRAMPON A  
ACORTAR A

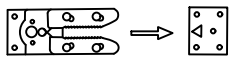

CLIP B  
CRAMPON B  
ACORTAR B

The diagram shows two metal connectors, Clip A and Clip B, which are used to connect the base to the sofa frame. Clip A has a male connector and Clip B has a female connector. An arrow points from Clip A to Clip B.

Connect corresponding male and female metal connectors at the bottom of the base.