BERTAZZONI DESIGN SERIES

36" WALL MOUNT HOOD K36 CON X



The Bertazzoni Design hoods are made in Italy with the same fit and finish and attention to details of every Bertazzoni appliance. They deliver extraction power up to 600 CFM with three different power settings and are equipped with aluminum mesh filters. They can be installed on the wall with the included duct cover. The design matches Bertazzoni ranges and cooktops 36 inches while also complementing other Bertazzoni Series.



TO COOK BEAUTIFULLY

BERTAZZONI DESIGN SERIES

36" WALL MOUNT HOOD K36 CON X

FEATURES

Hood finishing	stainless steel
Motor	1
Speed	3
Hood control	electronic
Halogen lights	2
Filters	aluminum mesh
Max extraction power	600 cfm

TECHNICAL SPECIFICATIONS

Voltage, Frequency	120 V, 60 Hz
Max Amp usage, power rating	3.3 A - 400 W
Certification	cETLus
Warranty	2 years parts and labor

ACCESSORIES

Extension Kit	code 901256
Recirculation Kit	code 901154

Duct cover included

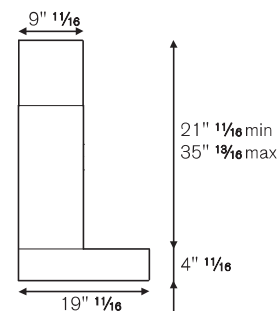
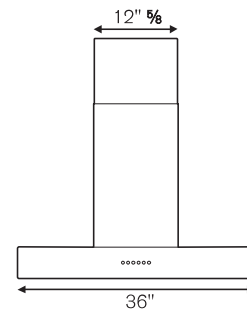
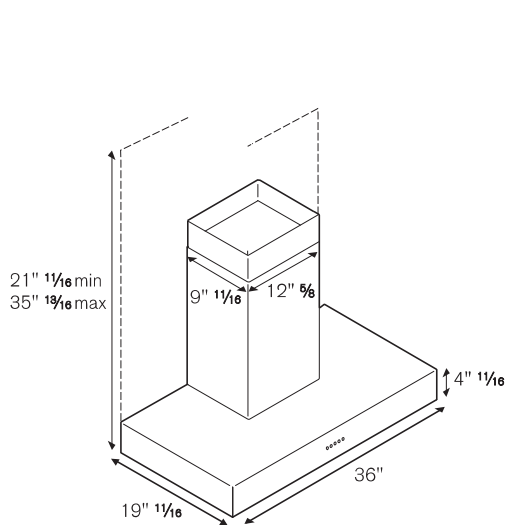

INSTALLATION INSTRUCTIONS

Bertazzoni recommends to operate the appliance after it has been properly installed. Please refer to the installation manual for further details.

Disclaimer: while every effort has been made to insure the accuracy of the information contained in this brochure, Fratelli Bertazzoni reserves the right to change any part of the information at any time without notice.

Fratelli Bertazzoni, Bertazzoni and the winged wheel brand icon are registered trademarks of Bertazzoni Spa.