



Operating and Installation Instructions Oven



To prevent accidents and machine damage, read these instructions **before** installation or use.

Contents

IMPORTANT SAFETY INSTRUCTIONS	4
Overview	14
Oven	14
Oven controls	15
Temperature selector.....	16
Features	18
Data plate	18
Scope of delivery.....	18
Standard and optional accessories.....	18
Safety features	22
PerfectClean treated surfaces.....	22
Before first use	23
Before using for the first time.....	23
Heating the oven for the first time.....	24
Overview of operating modes	25
Energy-saving tips	26
Using the oven	27
Simple operation	27
Preheating the oven	27
Operating the clock/timer.....	27
Switching cooking programs on and off automatically	27
Changing the time of day	30
Changing factory default settings	31
Switching the system lock  on and off.....	34
Using the timer 	35
Baking	36
Tips for baking.....	36
Notes on the operating modes.....	37
Roasting	38
Tips for roasting	38
Notes on the operating modes.....	39
Broiling	40
Tips for broiling.....	40
Notes on the operating modes.....	41

Further applications	42
Defrost	42
Dehydrating	43
Warm-up Cookware	43
Slow Roasting	44
Canning	46
Frozen food/ready meals	48
Cleaning and care of the oven	49
Unsuitable cleaning agents	49
Removing normal soiling	50
Removing stubborn soiling.....	50
Cleaning the oven compartment with Self clean 	50
Starting Self Clean.....	51
At the end of the Self Clean program	52
Self Clean interrupted.....	53
Removing the door.....	54
Installing the door.....	55
Side rack removal.....	56
Frequently Asked Questions	57
Customer Service	61
Contact in the event of a fault	61
Appliance warranty and product registration	61
Caring for the environment	62
Installation	63
Installation dimensions.....	63
Installation in a tall or base cabinet	63
Side view	64
Connections and ventilation.....	65
Installing and removing the oven	66
Taking the oven out of the housing unit	68
Electrical connection	69

IMPORTANT SAFETY INSTRUCTIONS

When using the appliance, follow basic safety precautions, including the following:

Read all instructions before installation and use of the oven to prevent accidents and machine damage.

This appliance complies with current safety requirements. Improper use of the appliance can lead to personal injury and material damage.

Read all instructions before installing or using the oven for the first time. Only use the appliance for its intended purpose.

Keep these operating instructions in a safe place and pass them on to any future user.

Appropriate use

- ▶ This oven is intended for domestic use and use in other similar environments.
- ▶ The oven is not intended for outdoor use.
- ▶ The oven is intended for cooking food – and, in particular, for baking, roasting, broiling, reheating, defrosting, and drying food – in domestic settings only.
All other types of use are not permitted.
- ▶ Risk of Fire! Do not use this oven to store or dry flammable materials.
- ▶ This oven can only be used by people with reduced physical, sensory, or mental capabilities or lack of experience and knowledge if they are supervised while using it.
They may only use it unsupervised if they have been shown how to do so in a safe manner. They must be able to understand and recognize the possible dangers caused by incorrect operation.

IMPORTANT SAFETY INSTRUCTIONS

▶ The oven compartment is equipped with special bulbs to cope with particular conditions (e.g., temperature, moisture, chemical resistance, abrasion resistance, and vibration). These special bulbs must only be used for the purpose for which they are intended. They are not suitable for room lighting.

Safety with children

▶ Children should be supervised in the vicinity of the oven. Never allow children to play with the oven.

▶ Burn Hazard - Do not allow children to use the oven. Failure to do so can result in severe burns or serious injury.

▶ Risk of suffocation from packaging material. While playing, children may become entangled in packaging material (such as plastic wrapping) or pull it over their head, presenting the risk of suffocation.

Keep packaging material away from children.

▶ Risk of injury caused by hot surfaces. Children's skin is far more sensitive to high temperatures than that of adults. External parts of the oven such as the door glass, control panel, and the vent become quite hot.

Do not let children touch the oven when it is in operation.

▶ Risk of injury caused by hot surfaces. Children's skin is far more sensitive to high temperatures than that of adults. The oven gets much hotter during the Self Clean program than during normal use. Do not let children touch the oven during the Self Clean program.

▶ Risk of injury from the open door. The oven door can support a maximum weight of 33 lbs (15 kg). Children could injure themselves on an open door.

Do not let children sit on the door, lean against it, or swing on it.

IMPORTANT SAFETY INSTRUCTIONS

Technical safety

- ▶ This appliance must be installed and connected in compliance with the installation instructions.
- ▶ Unauthorized installation, maintenance, and repairs can cause considerable danger for the user. Installation, maintenance, and repairs should only be carried out by a Miele authorized technician.
- ▶ Maintenance by the user: Never repair or replace any part of the appliance unless the instructions specifically recommend doing so. Service work should only be performed by a qualified technician.
- ▶ Damage to the oven can compromise your safety. Check the oven for visible signs of damage. Do not use a damaged oven.
- ▶ Temporary or permanent operation on an autonomous power supply system or a power supply system that is not synchronized with the grid power supply (e.g., island networks, back-up systems) is possible. A prerequisite for operation is that the power supply system complies with national and local codes.
The function and operation of the protective measures provided in the domestic electrical installation and in this Miele product must also be maintained in isolated operation or in operation that is not synchronized with the grid power supply, or these measures must be replaced by equivalent measures in the installation.
- ▶ The electrical safety of this appliance can only be guaranteed when correctly grounded. It is essential that this basic safety requirement is fulfilled. If in doubt, the electrical installation should be checked by a qualified electrician.
- ▶ Proper installation: Make sure that your appliance has been installed correctly and that it has been grounded by a qualified technician.

IMPORTANT SAFETY INSTRUCTIONS

- ▶ The connection data (voltage and frequency) on the data plate of the oven must match the domestic electrical supply in order to avoid the risk of damage to the oven. Compare this before connecting the appliance to the domestic electrical supply. If in any doubt, consult a qualified electrician.
- ▶ Power bars and extension cords do not guarantee the required safety of the appliance. Do not use these to connect the oven to the power supply.
- ▶ For safety reasons, only use the oven when it has been fully installed.
- ▶ This appliance must not be used in a non-stationary location (e.g., on a ship).
- ▶ Risk of injury due to electric shock. Any contact with live connections or tampering with the electrical or mechanical components of the oven will endanger your safety and may lead to appliance malfunctions.
Do not open the oven housing under any circumstances.
- ▶ While the appliance is under warranty, repairs should only be undertaken by a service technician authorized by Miele Customer Service. Otherwise the warranty will be invalidated.
- ▶ Miele can only guarantee the safety of the appliance when original Miele parts are used. Faulty components must only be replaced with genuine Miele parts.
- ▶ If the oven is delivered without a power cord, a special cord must be installed by a Miele authorized technician (see “Installation – Electrical connection”).
- ▶ If the power cord is damaged, it must be replaced with a special power cord by a Miele authorized technician (see “Installation – Electrical connection”).

IMPORTANT SAFETY INSTRUCTIONS

▶ During installation, maintenance, and repair work, e.g., if the oven interior lighting is faulty, the oven must be completely disconnected from the power supply (see “Frequently asked questions”). To ensure this:

- The circuit breakers have been switched off, or
- the fuses of the electrical installation have been completely removed, or
- the plug (if present) is removed from the outlet. To do this, pull the plug not the cord.

▶ The oven requires a sufficient supply of cool air for efficient operation. Make sure that the supply of cool air is not hindered in any way (e.g., by installing heat insulation strips in the cabinet niche). In addition, the required supply of cool air must not be excessively heated by other heat sources.

▶ If the oven is built in behind a cabinet door front, do not close the cabinet door while the oven is in use. Heat and moisture can build up behind the cabinet door when closed. This can result in damage to the oven, cabinet niche, and floor. Leave the cabinet door front open until the oven has cooled down completely.

Correct use

▶ Caution: Heating elements may be hot even though they are not glowing. Interior surfaces of an oven become hot enough to cause burns. External parts of the oven such as the door glass, vents, and the control panel can become hot. During and after use, do not touch, or let clothing or other flammable materials come into contact with heating elements or interior surfaces of the oven until they have had sufficient time to cool.

▶ Do not let food sit in the oven for an extended period of time before or after cooking. Doing so can result in food poisoning or sickness.

▶ Loose fitting or hanging garments present a fire hazard. Wear proper apparel while operating the appliance.

IMPORTANT SAFETY INSTRUCTIONS

- ▶ Use only dry, heat-resistant potholders. Moist or damp potholders used on hot surfaces may result in steam burns. Do not let potholders come in contact with oil or grease. Do not substitute dish towels or other bulky items for potholders. Do not let potholders touch hot heating elements.
- ▶ Open the door carefully to allow hot air or steam to escape before placing or removing food.
- ▶ To prevent burns, always place oven racks at their desired height while the oven is cool. If the rack must be moved while the oven is hot, do not let pot holders touch hot heating elements.
- ▶ To prevent burns, allow the heating elements to cool before cleaning by hand.
- ▶ Smother the fire or flames, or use a dry chemical extinguishing agent or foam fire extinguisher.
- ▶ Never store flammable liquids and materials in, above or under an oven, or near cooking surfaces.

WARNING

NEVER use this appliance as a space heater to heat or warm the room. Doing so may result in carbon monoxide poisoning and overheating of the oven.

WARNING



NEVER use this appliance as storage space. Doing so may result in carbon monoxide poisoning and overheating of the oven.

WARNING

NEVER cover any slots, holes or openings in the oven bottom or cover an entire rack with materials such as aluminum foil. Doing so blocks air flow through the oven and may cause carbon monoxide poisoning. Aluminum foil linings may also trap heat, causing a fire hazard.

- ▶ Do not obstruct the flow of combustion and ventilation air.

IMPORTANT SAFETY INSTRUCTIONS

- ▶ This oven must only be used for cooking food. Corrosive chemicals and vapors as well as fumes, vapors or heat given off by glues, plastics or flammable liquids and materials could be hazardous. Do not use it as a dryer, kiln, dehumidifier, etc.
- ▶ Do not let metal objects (aluminum foil, pans) come in contact with the heating element.
- ▶ Make certain that the power cords of small appliances do not come in contact with or get caught in the oven door.
- ▶ When baking frozen pizzas or pies, place them on the wire rack lined with parchment paper. Do not use the baking tray or the roasting pan for frozen foods with a large surface area. The tray or pan could become warped and difficult to remove from the oven when hot. Frozen foods like french fries, chicken nuggets, etc. can be baked on the baking tray.
- ▶ Risk of injury caused by hot surfaces. The oven gets hot during operation. You could burn yourself on the heating elements, oven compartment, accessories, or food.
When the oven is hot, use pot holders to insert, remove, or turn food, as well as when adjusting the oven shelves, etc.
- ▶ Due to the high temperatures radiated, objects left near the oven could catch fire. Do not use the oven to heat up the room.
- ▶ Oils and fats are a fire hazard if allowed to overheat. Never leave the oven unattended when cooking with oil or fats. Never attempt to put out oil or fat fires with water. Turn the oven off and extinguish the flames by leaving the door closed.
- ▶ Broiling food for excessively long cooking durations can cause it to dry out with the risk of catching fire. Do not exceed the recommended cooking durations.
- ▶ Certain foods dry out quickly and may catch fire due to high broiling temperatures.
Never use broiling modes to finish baking par-cooked rolls or bread, or to dry flowers or herbs. Instead, use the Convection Bake  or Surround  operating mode.

IMPORTANT SAFETY INSTRUCTIONS

- ▶ If using alcohol in your recipes, please be aware that high temperatures can cause the alcohol to evaporate. The vapor can catch fire on hot heating elements.
- ▶ When using residual heat to keep food warm, corrosion from high air humidity and condensation can occur in the oven. This can cause damage to the control panel, countertop, and cabinet carcass. Keep the oven on and select the lowest temperature available for the selected operating mode. The cooling fan will then continue to run automatically.
- ▶ Food which is stored in the oven compartment or left in it to be kept warm can dry out and the moisture released can lead to corrosion damage in the oven. Always cover food that is left in the oven to keep warm.
- ▶ A buildup of heat can cause the floor of the oven to crack or flake off. Never line the floor of the oven with aluminum foil or oven liners. If you wish to place dishware on the floor of the oven during the cooking process, or place dishware on the floor of the oven to heat it up, you can do so, but only with the Convection Bake  operating mode.
- ▶ The oven floor can become damaged by items being pushed around on it. When placing pots, pans, or dishware on the oven floor, do not push them around.
- ▶ Risk of injury caused by steam. Pouring a cold liquid onto a hot surface creates steam, which can cause severe scalding. The sudden temperature change can also cause damage to hot surfaces. Never pour cold liquids directly onto hot enameled surfaces.
- ▶ It is important that the temperature in the food being cooked is evenly distributed and sufficiently high. You can ensure this by stirring or turning the food.
- ▶ Plastic containers which are not heat-resistant melt and may ignite at high temperatures and can damage the oven. Use only plastic containers that are suitable for use in an oven. Follow the manufacturer's instructions.

IMPORTANT SAFETY INSTRUCTIONS

- ▶ Canning food and heating it up in closed containers results in an increase in pressure which can cause them to explode. Do not use cans for canning or reheating food.
- ▶ Risk of injury from the open door. You could bang into the open door or trip over it. Do not leave the door open unnecessarily.
- ▶ The door can support a maximum load of 33 lbs (15 kg). Do not lean or sit on an open door, or place heavy items on it. Make sure that nothing gets trapped between the door and the oven compartment. This could damage the oven.

The following applies to stainless steel surfaces:

- ▶ Adhesives will damage the coated stainless steel surface and cause it to lose its dirt-repellent protective coating. Do not use sticky notes, adhesive tape, or other types of adhesive on the stainless steel surface.
- ▶ Magnets can cause scratches. Do not use the stainless steel surface as a magnetic notice board.

Cleaning and care

- ▶ Only clean parts listed in these operating and installation instructions.
- ▶ There is a delicate fiberglass seal around front of the oven compartment provide a seal for the glass on the inside of the oven door. This can be damaged by rubbing or scouring. If possible, refrain from cleaning this.
- ▶ Do not use oven cleaners. Do not use standard oven cleaners in the oven compartment or on the front of the oven. Never line the oven with oven liners.
- ▶ Risk of injury due to electric shock. The steam from a steam cleaning appliance could reach live electrical components and cause a short circuit. Never use a steam cleaner for cleaning.

IMPORTANT SAFETY INSTRUCTIONS

- ▶ Scratches on the door glass can cause the glass to break. Do not use abrasive cleaners, hard sponges, brushes, or sharp metal tools to clean the door glass.
- ▶ The side runners can be removed (see “Cleaning and care of the oven – Removing the side runners”). Reinstall the side runners correctly.
- ▶ Coarse soiling in the oven compartment can cause thick smoke to develop. Remove coarse soiling from the oven compartment before running the Self Clean program.
- ▶ In warm, moist environments, there is a higher probability of pest infestations. Ensure the oven and the area surrounding it are always kept clean.
Damage caused by pests is not covered by the warranty.

Accessories

- ▶ Only use original Miele accessories. Using parts or accessories from other manufacturers will invalidate the warranty, and Miele cannot accept liability.
- ▶ Accessories that are not suitable for the Self Clean program will be damaged by the high temperatures.
Remove all accessories that are not suitable for the Self Clean program from the oven compartment before starting the Self Clean program. This also applies to the side runners and any optional accessories.

KEEP THE OPERATING AND INSTALLATION INSTRUCTIONS IN A SAFE PLACE AND REVIEW THEM PERIODICALLY.

Overview

Oven

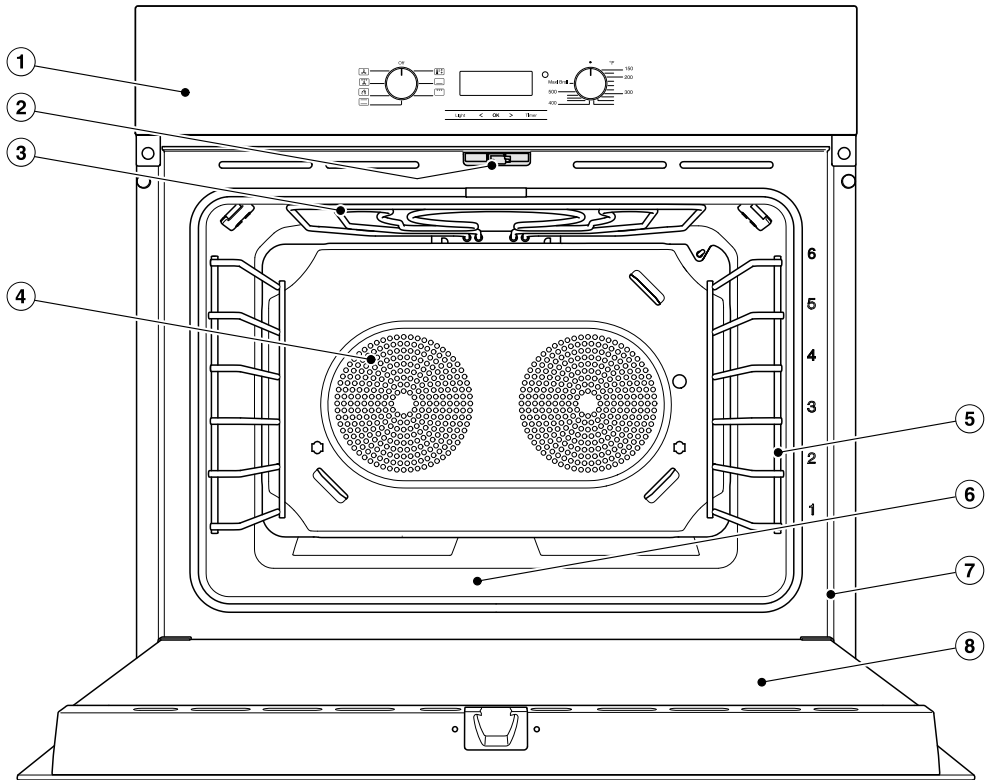

- ① Controls
- ② Door lock for Self Clean
- ③ Browning/Broiling element
- ④ Air inlets for the blowers with ring heating elements behind them
- ⑤ Side runners with 6 shelf levels
- ⑥ Oven floor with bottom heat element underneath it
- ⑦ Front frame with data plate
- ⑧ Door

Oven controls

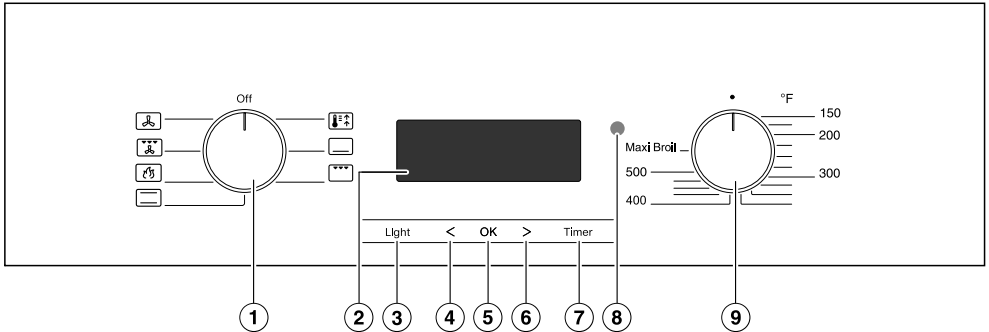

- ① Mode selector
For selecting operating modes
- ② Clock/timer
For displaying the time of day and settings
- ③ *Light* sensor button
For switching the oven interior lighting on and off
- ④ < sensor button
For changing times and settings
- ⑤ OK sensor button
For accessing functions and saving settings
- ⑥ > sensor button
For changing times and settings
- ⑦ *Timer* sensor button
To activate or deactivate a timer
- ⑧ Optical interface
(for Miele Service only)
- ⑨ Temperature selector
For setting the temperature

Oven controls

Temperature selector

Use the temperature selector to select the temperature for the cooking processes.

It can be turned clockwise until a resistance is felt and then turned back again. When the function selector is in the • position, it can be retracted by pushing it in.

The temperature settings on the control panel start at 150°F. You can also set lower temperatures between the • position and 150°F.

Mode selector

The mode selector is used to select operating modes.

You can turn the mode selector clockwise and counter-clockwise. When the mode selector is in the *Off* position, it can be retracted by pushing it in.

Operating modes

Booster 

Bake 

Maxi Broil 

Surround 

Self clean 

Convection Broil 

Convection Bake 

Clock/timer

The clock/timer is operated via the **display** with the **sensor buttons**.

Display

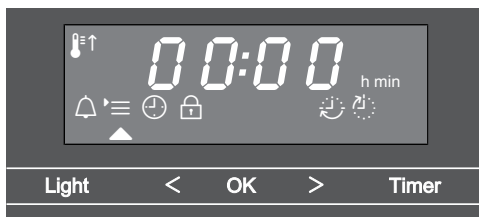







The display shows the time of day or your settings.

Please refer to “Using the oven – Operating the clock/timer” for more information.

Symbols in the display

Depending on the position of the mode selector and/or which button is pressed, the following symbols will appear:

Symbol/function		○
	Timer	Any
	Temperature indicator light	Operating mode
	Cooking duration	
	End of cooking duration	
	Settings <i>P</i>	<i>Off</i>
	Time	
	System lock	

○ Mode selector position
You can only set or change a function if the mode selector is in the corresponding position.

Sensor buttons

The range has the following touch-sensitive sensor buttons: *Light*, *<*, *OK*, *>*, and *Timer*. Every touch on the sensor buttons is confirmed by a keypad tone.

The keypad tone can be switched off by changing setting *P 4* to status *5 1* (see “Using the oven – Operating the clock/timer”).

Temperature indicator light

The temperature indicator light  lights up when the oven is heating.

As soon as the selected temperature is reached, the oven heating switches off and the temperature indicator light goes out.

The temperature control unit ensures that the oven heating and the temperature indicator light switch back on if the oven temperature falls below the level set.

Features

A list of the models described in these operating and installation instructions can be found on the back page.

Data plate

The data plate located on the front frame of the oven is visible when the door is open.

The data plate states the model number, the serial number, and connection data (voltage, frequency, and maximum rated load).

Have this information available if you need to contact Miele so that any issues can be rectified as quickly as possible.

Scope of delivery

- Operating and installation instructions for using the oven
- Screws for securing the oven to the cabinet niche
- Various accessories

Standard and optional accessories

Features will vary depending on model.

The side runners, universal tray, and wire rack (or “rack” for short) are supplied as standard with the oven.

Depending on the model, your oven may also come supplied with some of the accessories listed here.

All accessories and cleaning and care products in these instructions are designed to be used with Miele Ovens.

These can be ordered from the Miele web store, Miele Customer Service, or from your Miele dealer.

When ordering, please have your model number ready along with the desired accessories.

Side racks

Side racks for accessories are installed on either side of the oven compartment for shelf levels .

The shelf level numbers are indicated on the front of the oven frame.

Each level consists of a rail on which you can place the wire rack, for example.

You can remove the side racks (see “Cleaning and care of the oven – Side rack removal”).

Universal tray and Wire Rack with anti-tip safety notches

Universal tray HUBB 30-1:

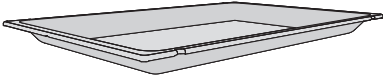

Wire Rack HBBR 30-2:

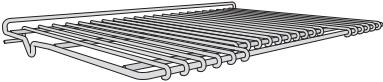

Safety notches are located on the short edges of the Wire Rack. These prevent the Wire Rack from being fully pulled out of the side racks when it only needs to be pulled partially out.

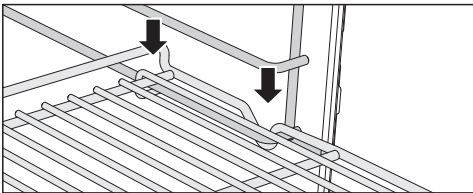

Always slide the Wire Rack into the rails of the side racks with the catches facing down.

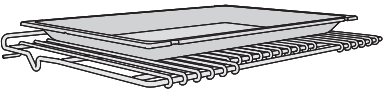

Tip: When using the universal tray, place it directly on the Wire Rack.

FlexiClips with Wire Rack HFCBRR 30-3

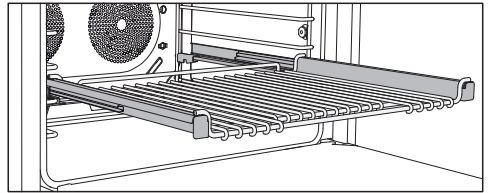

The FlexiClips with Wire Rack are mounted on the side racks and can be pulled completely out of the oven. This allows you to see the food easily.

The FlexiClips with Wire Rack are pushed onto the rails of a level and then locked into place.

The FlexiClips can support a maximum load of 33 lb (15 kg).

The FlexiClips with Wire Rack can be mounted on any shelf level.

Installing and removing the FlexiClips with Wire Rack

⚠ Danger of injury caused by hot surfaces.

The oven gets hot during operation. You could burn yourself on the heater elements, oven compartment, or accessories.

Allow the heating elements, oven compartment, and the accessories to cool down before installing or removing the FlexiClips with Wire Rack.

When installing or removing the FlexiClips, **do not** extend them.

- Hold the FlexiClips with Wire Rack with both hands and position them in front of the desired level.

Features

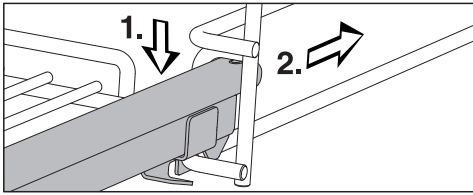

- Insert the FlexiClips with Wire Rack onto the level (1.) and slide them along the struts of the level (2.) until they click into place.

If the FlexiClips are difficult to pull out after installing, you may need to pull firmly on them once to release them.

Tip: When using the universal tray, place it directly on the FlexiClips with Wire Rack.

To remove the FlexiClips with Wire Rack, proceed as follows:

- Push the FlexiClips with Wire Rack in all the way.

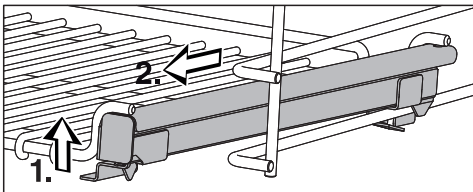

- Lift the front of the FlexiClips with Wire Rack on both sides (1.) and pull them out of the level (2.).

Perforated Gourmet Baking Tray HBBL 71

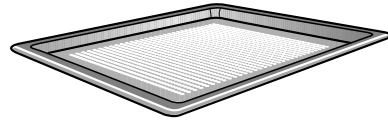

The perforated Gourmet Baking Tray has been specially developed for preparing baked goods made from fresh yeast doughs.

The tiny perforations assist in browning the underside of baked goods.

The Gourmet Baking Tray can also be used for dehydrating or drying food.

The enameled surface has been treated with PerfectClean.

The **round perforated baking tray HBFP 27-1** can be used for these purposes.

Round baking pans



The **solid round baking pan HBF 27-1** is suitable for cooking pizzas, flat cakes, sweet and savory tarts, baked desserts, flat bread, and can also be used for frozen cakes.

The **perforated round baking pan HBFP 27-1** has been specially developed for baked goods made from fresh yeast dough, and for baking bread and rolls. The tiny perforations assist in browning the underside of baked goods.

They can also be used for dehydrating or drying food.

The enameled surface of both baking pans has been treated with PerfectClean.

- Insert the wire rack and place the round baking pan on the rack.

Broiling and roasting insert HGBB 30-1

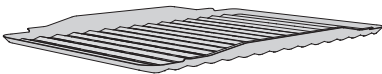

The broiling and roasting insert fits in the universal tray.

The tray will collect meat juices and stop them from burning so that they can be used for making gravy and sauces.

The enameled surface has been treated with PerfectClean.

HUB Gourmet Casserole Dishes HBD Gourmet Casserole Dish lids

Miele Gourmet Casserole Dishes can be placed directly on the wire rack. The surface of the casserole dishes has a non-stick coating.

Gourmet Casserole Dishes are available in different depths. The width and the height are the same.

Suitable lids are available separately. Please quote the model designation when ordering.

Depth:
8 1/2" (22 cm)

HUB 5001-M*

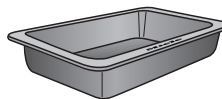

HBD 60-22

Depth:
13 3/4" (35 cm)

HUB 5001-XL*

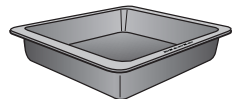

HBD 60-35

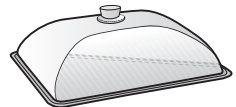
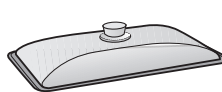

* Suitable for use on induction cooktops

Accessories for cleaning and care

- Opener
The opener is used for removing the cover from the oven lighting.

Features

Safety features

- **System lock**  for the oven (see “Using the oven – Operating the clock/timer”)
- **Cooling fan**
The cooling fan will come on automatically when a cooking program is started. It ensures that the hot air in the oven compartment is mixed with cool ambient air and thus cooled before it is expelled via the gap between the door and the control panel.
The cooling fan will continue to run for a while after the oven has been turned off to prevent any humidity building up in the oven, on the control panel, or in the cabinet carcass.
The cooling fan will switch itself off automatically after a certain period of time.
- **Safety shut-off**
This safety shut-off is activated automatically if the oven has been operating for an unusually long period of time. The period of time will depend on the particular operating mode being used.
- **Ventilated door**
The oven door is made of glass panes that have a heat-reflective coating on part of their surface. When the oven is operating, air is passed through the door to keep the outer pane cool.
You can remove the door for cleaning purposes (see “Cleaning and care of the oven”).

- **Door locking** for Self Clean
At the beginning of a Self Clean program, the door will lock for safety reasons. The door will only unlock when the temperature in the oven compartment has dropped to below 535°F (280°C).

PerfectClean treated surfaces

PerfectClean surfaces have very good non-stick properties making them exceptionally easy to clean.

Food can be easily removed from these surfaces. Soiling from baking and roasting can also be easily removed from these surfaces.

However, do not use ceramic knives as these will scratch the PerfectClean surface.

Read the instructions in “Cleaning and care of the oven” to retain the benefits of the non-stick properties and easy cleaning.

PerfectClean treated surfaces:

- Universal tray
- Broiling and roasting insert
- Perforated Gourmet Baking Tray
- Round baking pan
- Round perforated baking pan

Before using for the first time

 Danger of injury caused by hot surfaces.

The oven gets hot during operation. For safety reasons, only use the oven when it has been fully installed.



- Press and release the mode and temperature selectors if they are retracted.

The time of day can only be changed when the mode selector is at *Off*.

- Set the time of day.

Setting the time of day for the first time

The time of day is shown in 12-hour clock format.

After connecting the range to the electrical supply *12:00* will appear in the display and the triangle  will flash under .



- Use < or > to set the time of day.
- Confirm with *OK*.

The time of day is now saved.

The time of day can be displayed in 24-hour format by setting *P 4* in the settings menu to status *24h* (see “Using the oven – Operating the clock/timer”).

The time of day is saved for approx. 150 hours in the event of a power failure. If the power is restored within this period, the current time will be displayed again. If the power supply is interrupted for longer, the time of day must be reset.

The time of day display (*P 1*) is switched off by default (see “Using the oven – Operating the clock/timer”). The display appears dark if the oven is switched off. The time of day continues to run in the background.

Before first use

Heating the oven for the first time

New ovens may have a slight odor when they are heated up for the first time. Heating up the oven for at least an hour with nothing in it will eliminate the odor.

Ensure that the kitchen is well ventilated while the appliance is being heated up for the first time. Close doors to other rooms to prevent the odor spreading throughout the house.

- Remove any adhesive labels or protective films from the ovens and accessories.
- Before heating the oven up, wipe the interior with a damp cloth to remove any dust or bits of packaging that may have accumulated in the oven compartment.
- Insert the FlexiClips with Wire Rack into the side racks and place all trays and the Wire Rack in the oven.
- Select the Convection Bake  operating mode.

The oven interior lighting and the fan will switch on.

- Set the maximum temperature (500°F).

The oven heating will switch on.

- Heat up the oven for at least an hour.
- After heating up, turn the mode selector to *Off*.
- After heating up, turn the temperature selector to •.

Cleaning the oven compartment after heating it up for the first time







 Risk of injury caused by hot surfaces.

The oven gets hot during operation. You could burn yourself on the heating elements, oven compartment, or accessories. Allow the heating elements, oven compartment, and accessories to cool before manual cleaning.

- Take all accessories out of the oven compartment and clean it by hand (see “Cleaning and care of the oven”).
- Clean the oven compartment with warm water and liquid dish soap, applied with a soft sponge or microfiber cloth.
- Dry all surfaces with a soft cloth.



Leave the oven door open until the oven compartment is completely dry.

Overview of operating modes

Operating modes	Range
Booster 	85–500 °F (30–250 °C)
Bake 	85–500 °F (30–250 °C)
Maxi Broil 	<i>Maxi Broil</i>
Surround 	85–500 °F (30–250 °C)
Self clean 	–
Convection Bake 	85–500 °F (30–250 °C)
Convection Broil 	85–500 °F (30–250 °C)

Energy-saving tips

Cooking programs

- Remove all accessories from the oven that are not required for a cooking process.
- If a temperature range is given, it is best to select the lower temperature and check the food after the shortest cooking time given.
- Preheat the oven only if instructed to do so in the recipe.
- Try not to open the door when cooking.
- It is best to use dark bakeware and cooking containers with a matte finish made of non-reflective materials (enameled steel, heat-resistant glass, non-stick coated cast aluminum). Shiny materials such as stainless steel or aluminum reflect the heat and therefore can give a more uneven result. Do not cover the oven floor or the Wire Rack with heat-reflecting aluminum foil.
- Monitor cooking durations to avoid wasting energy when cooking. Set the cooking duration, or use a food probe if you have one.
- The Convection Bake  operating mode can be used for cooking many types of food. Because the blower distributes the heat in the oven compartment straight away, it allows you to use a lower temperature than you would with Surround . It also enables you to cook on multiple shelf levels at the same time.
- Convection Broil  is the best operating mode for broiled dishes. Lower temperatures can be used than with other broil modes that use the maximum temperature setting.
- Whenever possible you should cook several dishes at the same time. Place them next to each other in the oven or on different shelf levels.
- Dishes which you are unable to prepare at the same time should, if possible, be cooked one after the other in order to make use of existing heat in the oven.

Residual heat utilization

- The temperature in cooking programs using temperatures above 285°F (140°C) which take longer than 30 minutes to cook can be turned down to the lowest possible temperature about 5 minutes before the end of cooking. The residual heat in the oven is sufficient for cooking the food until it is done. However, do not turn the oven off (see “IMPORTANT SAFETY INSTRUCTIONS”).
- It is best to start the Self Clean program immediately after a cooking program. The residual heat in the oven will help reduce the amount of energy required.

Energy-saving mode

The oven will turn itself off automatically to save energy if a program is not being run and no controls have been operated. The time of day will appear on the display or the display will remain dark (see “Operating the clock/timer”).

Simple operation

- Place the food in the oven.
- Select the required operating mode with the mode selector.

The oven interior lighting and the fan will switch on.

- Select the temperature with the temperature selector.

The oven heating will switch on.



After the cooking program:

- Turn the mode selector to *Off* and the temperature selector to ●.
- Take the food out of the oven.

Preheating the oven

The Booster  operating mode is used to quickly pre-heat the oven.

The oven compartment only needs to be preheated in a few cases.

- You can place most dishes in the cold oven compartment to make use of the heat produced during the heating-up phase.
- Preheat the oven when cooking the following food with the following operating modes:
 - dark bread dough and beef sirloin joints and fillet with the Convection Bake  and Surround  operating modes
 - cakes and pastries with a short cooking duration (approx. 30 minutes or less) as well as delicate items (e.g., sponge) with the Surround  operating mode

Using Booster

You can shorten the heating-up phase with the Booster  function.

Do not use the Booster  operating mode to pre-heat the oven when baking pizzas or delicate mixtures (e.g., sponge cake, cookies).

This food will otherwise brown too quickly from the top.

- Select Booster .
- Select the temperature.
- Change to the required operating mode after the set temperature has been reached.
- Place the food in the oven.

Operating the clock/timer

Switching cooking programs on and off automatically

Cooking programs can be switched on or off automatically.

To do this, set a cooking duration or a cooking duration and a finish time after selecting the operating mode and temperature.

The maximum duration which can be set for a cooking program is 11 hours and 59 minutes.

It is recommended to switch on and off automatically when roasting. If used for baking, do not delay the start for too long. Otherwise the cake mixture or dough will dry out, and the raising agents will lose their effectiveness.

Using the oven

Setting the cooking duration

Example: a cake needs to bake for 1 hour and 5 minutes.

- Place the food in the oven.
- Select the required operating mode and the temperature.

The oven heating, lighting, and cooling fan will turn on.

- Select **OK**.
- If necessary, use < or > to move the triangle ▲ until it appears under ⌚.
- Confirm with **OK**.

00:00 h will appear in the display with the triangle ▲ flashing under ⌚.



- Use < or > to set the cooking time (01:05).
- Confirm with **OK**.

The cooking duration is now saved and will count down in minutes until the last minute, which will count down in seconds.

The ⌚ symbol indicates that a cooking duration has been set.

Setting a cooking duration and a finish time

Example: the current time of day is 11:15 am; a roast with a cooking duration of 90 minutes needs to be ready at 1:30 pm.

- Place the food in the oven.
- Select the required operating mode and the temperature.

The oven heating, lighting, and cooling fan will turn on.

First set the cooking duration:

- Select **OK**.
- If necessary, use < or > to move the triangle ▲ until it appears under ⌚.
- Confirm with **OK**.

00:00 h will appear in the display with the triangle ▲ flashing under ⌚.

- Use < or > to set the cooking time (01:30).
- Confirm with **OK**.

The cooking duration ⌚ is saved and then counts down in minutes:



Then set the finish time:

- Move the triangle ▲ with < or > until it appears under ⌚.

-- -- appears:



- Confirm with *OK*.

12:45 (current time of day + cooking duration = 11:15 + 1:30) appears in the display:



- Use < or > to set the end of the cooking time (13:30).
- Confirm with *OK*.

The finish time ⌚ is now saved:



The oven heating, lighting and cooling fan will switch off.

As soon as the start time (13:30 - 1:30 = 12:00) has been reached, the oven heating, lighting and cooling fan will switch on.

At the end of the cooking duration:

- 0:00 appears.
 - ⌚ flashes.
 - The oven heating switches off automatically.
 - The cooling fan continues to run.
 - An audible signal will sound if the audible signal is switched on.
- Turn the mode selector to *Off*.
 - Turn the temperature selector to ●.
 - Take the food out of the oven.

If the dish is not cooked to your satisfaction you can prolong the cooking duration by entering a new duration.

Changing the cooking duration

- Select *OK*.
- If necessary, use < or > to move the triangle ▲ until it appears under ⌚.

The remaining cooking duration will appear in the display.

- Confirm with *OK*.
- Change the cooking time with < or >.
- Confirm with *OK*.

The changed cooking duration is now saved.

Using the oven

Deleting a cooking duration

- Select *OK*.
- If necessary, use < or > to move the triangle ▲ until it appears under .
- Confirm with *OK*.

The triangle ▲ flashes under .

- Use < to set the cooking time to *00:00*.
- Confirm with *OK*.

The cooking duration and any finish time set are deleted.

- Select *OK*.

The actual temperature will appear. The oven heating remains switched on.

If you want to end the cooking program:

- Turn the mode selector to *Off*.
- Turn the temperature selector to ●.
- Take the food out of the oven.

If the mode selector is turned to the *Off* position, the settings for cooking duration and end of cooking duration will be deleted.

Deleting a finish time

- Select *OK*.
- If necessary, use < or > to move the triangle ▲ until it appears under .
- Confirm with *OK*.

The triangle ▲ flashes under .

- Use < or > to set the end of the cooking time to - :- -.
- Confirm with *OK*.

The finish time is deleted.

Changing the time of day

The time of day can only be changed when the mode selector is at *Off*.

- Turn the mode selector to *Off*.
- Select *OK*.
- Move the triangle ▲ with < or > until it appears under .
- Confirm with *OK*.

The triangle ▲ flashes under .

- Use < or > to set the time of day.
- Confirm with *OK*.

The time of day is now saved.

The time of day is saved for approx. 150 hours in the event of a power failure. If the power is restored within this period, the current time will be displayed again.

If the power supply is interrupted for longer, the time of day must be reset.

Changing factory default settings

Default settings are set in the oven controls at the factory (see “Settings overview”).

A setting can be changed by altering its status.

The settings can only be changed when the mode selector is at *Off*.

- Select *OK*.
- If necessary, use < or > to move the triangle ▲ until it appears under '≡.



- Confirm with *OK*.

P 1 appears:

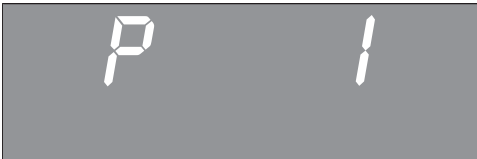

- If you want to change another setting, select the appropriate number with < or >.
- Confirm with *OK*.

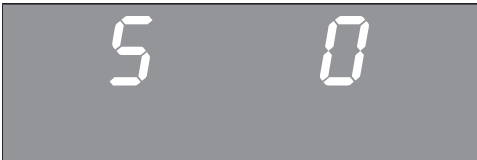

The setting is selected and the current status appears, e.g., *5 0*.

To change the status:

- Set the desired status using < or >.

- Confirm with *OK*.

The status is saved and the setting appears again.

- To change additional settings, proceed in the same way.
- If you do not want to change any further settings, select '≡.

The settings will remain in the memory in the event of a power failure.

Using the oven

Settings overview

Setting	Status
<i>P 1</i> Time of day display	<i>5 0</i> * The time of day display is deactivated . The display appears dark if the oven is switched off. The time of day continues to run in the background. If you have selected the status <i>5 0</i> , the oven has to be turned on before you can use it. The same applies if you set a timer with the <i>Timer</i> sensor button or want to use the <i>Light</i> sensor button to switch on the oven interior lighting. The oven will also switch off automatically if you do not make any settings within a certain amount of time (approx. 30 minutes). <i>5 1</i> The time of day display is switched on . The time of day is visible in the display.
<i>P 2</i> Audible signal volume	<i>5 0</i> The audible signal is switched off . <i>5 1</i> to <i>5 21</i> * The audible signal is switched on . You can adjust the volume. When you select a status you will hear the corresponding audible signal.
<i>P 3</i> Keypad tone	<i>5 0</i> The keypad tone is turned off . <i>5 1</i> * The keypad tone is turned on .
<i>P 4</i> Time of day format	<i>12h</i> * The time of day is shown in the 12-hour format . If you change the clock after 1:00 pm from a 12-hour clock to a 24-hour clock you will need to update the hour accordingly. <i>24h</i> The time of day is shown in the 24-hour format .

* Factory default

Using the oven

Setting	Status
<i>P 5</i> Display brightness	<i>5 1</i> to <i>5 7</i> , <i>5 4</i> * <i>5 1</i> : minimum brightness <i>5 7</i> : maximum brightness
<i>P 6</i> Lighting	<i>5 0</i> * The oven interior lighting is on for 15 seconds and then turns off automatically. <i>5 1</i> The oven interior lighting is permanently turned on .
<i>P 7</i> Temperature control	<i>0</i> * <i>-3</i> to <i>3</i> You can change the temperature in increments in all operating modes so that it is higher or lower in the oven compartment than displayed. The higher the setting, the higher the oven temperature.
<i>P 8</i> Electrical Version	<i>208U</i> You can set the voltage variant: 208 V, 60 Hz <i>220U</i> You can set the voltage variant: 220 V, 60 Hz <i>240U</i> You can set the voltage variant: 240 V, 60 Hz
<i>P 9</i> Demo mode	<i>5 0</i> * Select <i>5 0</i> and press OK for approx. 4 seconds. Demo mode is deactivated as soon as - - - - is shown briefly in the display. <i>5 1</i> Select <i>5 1</i> and press OK for approx. 4 seconds. Demo mode is activated as soon as <i>DE5_</i> is shown briefly in the display. The oven can be operated, however the heating elements will not work. Do not activate this setting for domestic use.

* Factory default

Using the oven

Switching the system lock on and off



The system lock  prevents the oven from being used unintentionally.

The appliance is delivered with the system lock deactivated. The setting for the system lock can be changed by altering its status 5:

- 5 0 = off
- 5 1 = on

The system lock status can only be changed when the mode selector is at *Off*.

Activating the system lock

- Select *OK*.
- Move the triangle  with < or > until it appears under .



- Confirm with *OK*.

The currently set status 5 1 appears and the triangle  flashes under .



- Use < or > to set the status 5 0.



- Confirm with *OK*.



The system lock is activated.

When the appliance is switched on again, the  symbol will appear in the display to remind you that the system lock has been activated.

The system lock will remain activated even after a power failure.

Deactivating the system lock for a cooking process

- Select an operating mode.



The  and  symbols and the current time of day will appear:





- Touch *OK* until  goes out.

The oven can now be used.

Deactivating the system lock

- Turn the mode selector to *Off*.
- Touch *OK* until  goes out.
- Select *OK*.
- Move the triangle  with < or > until it appears under .
- Confirm with *OK*.

The currently set status 5 1 appears and the triangle  flashes under .

- Use < or > to select the status 5 0.

- Confirm with *OK*.

The system lock is deactivated.

The  symbol disappears.

Using the timer

The timer can be used to time any activity in the kitchen, e.g. boiling eggs.



The timer can also be used at the same time as a cooking program if a start and finish time have been set, e.g. a reminder to stir the dish or add seasoning.

A maximum time of 99 minutes and 55 seconds can be set for the timer.

Setting the timer

Example: you want to boil some eggs and set a timer of 6 minutes and 20 seconds.

- Select the *Timer* sensor button.

00:00 will appear in the display with the triangle  flashing under :



- Use < or > to set the timer as desired.



- Confirm with *OK*.

The timer duration is now saved and will count down in seconds:



The  symbol indicates that the timer has been set.

When the timer elapses

-  flashes.
- The time will count upwards.
- An audible signal will sound if the audible signal is turned on.

- Select the *Timer* sensor button.

The audible signal will stop and the symbols on the display will go out.

Changing the timer

- Select the *Timer* sensor button.

The current timer appears.

- Use < or > to change the time set for the timer.
- Confirm with *OK*.

The modified timer duration is saved and will count down in seconds.

Deleting the timer

- Select the *Timer* sensor button.
- Use < to reduce the timer time to 00:00.
- Confirm with *OK*.

The timer is deleted.

Baking

Handling and cooking food correctly is essential for maintaining good health.

Cakes, pizzas, and French fries should be cooked until golden, not dark brown.

Always observe USDA/CFIA food safety guidelines.

Tips for baking

- Set a cooking duration. If used for baking, do not delay the start for too long. Otherwise the cake mixture or dough will dry out, and the raising agents will lose their effectiveness.
- Generally speaking, you can use wire racks, baking trays, universal trays, and any type of bakeware made of heat-resistant material.
- Avoid using bright, thin-walled pans made from a shiny material as they give an uneven or poor browning result. In certain unfavorable conditions, the food will not cook properly.
- Place cakes in rectangular bakeware on the wire rack with the longer side across the width of the oven for optimum heat distribution and even results.
- Always place bakeware on the wire rack.
- When baking cakes with fruit toppings or deep cakes, place the pan on the universal tray to catch any spillages.

Using parchment paper

Miele accessories, e.g., the universal tray, are treated with PerfectClean (see “Features”). Surfaces treated with PerfectClean generally do not need to be greased or covered with parchment paper.

- Use parchment paper when baking lye mixtures (e.g., pretzels) because the sodium hydroxide can damage the PerfectClean treated surface.
- Use parchment paper when baking sponge cake, meringue, macaroons, or similar items. These are more likely to stick due to their high egg white content.
- Use parchment paper when cooking frozen food on the wire rack.

Selecting the temperature

- As a general rule, select the temperature given in the corresponding recipe.

Choosing a baking temperature higher than those recommended may reduce the cooking time, but will lead to uneven browning and unsatisfactory cooking results.

Selecting the cooking duration

- Check whether the food is cooked shortly before the end of the specified cooking duration. Stick a wooden skewer into the food.

If it comes out clean without any batter/dough on it, the food is done.

Notes on the operating modes

A list of all operating modes can be found in “Overview of operating modes”.

Using Convection Bake

Because the blower distributes the heat around the oven compartment straight away, you can use a lower temperature than you would with the Surround  operating mode.

Use this operating mode if you are baking on multiple shelf levels at the same time.

- 1 shelf: place the food on shelf level 3.
- 2 shelves: place the food on shelf levels 1+3 or 2+4.
- 3 shelves: place the food on shelf levels 1+3+5.

Tips

- If you are cooking on multiple shelf levels at the same time, slide the universal tray in on the lowest level.
- For moist cookies and cakes, bake on a maximum of 2 shelf levels at once.

Using Surround

Dark metal, enamel, or aluminum bakeware with a matte finish, as well as heat-resistant glass, ceramic, and coated bakeware can be used.

Use this operating mode for cooking traditional recipes. If using an older recipe or cookbook, set the oven temperature 50°F (10°C) lower than that recommended. This will not change the cooking duration.

- Place the food on shelf level 3.

Roasting



Always observe USDA/CFIA food safety guidelines.

Tips for roasting

- You can use all dishware made from temperature-resistant materials, e.g., roasting dishes, roasting pans with lid, ovenproof glass dishes, roasting bags, dishes made from earthenware or cast iron, the universal tray, wire rack, and/or anti-splash insert (if available) on top of the universal tray.
- **Preheating** the oven is only required when preparing roast beef and fillets. Preheating is generally not necessary.
- Use a **closed cooking container** for roasting meat, such as a roasting dish. The meat will stay succulent. The oven compartment will also stay cleaner than when roasting on the wire rack. It ensures that enough stock remains for making gravy.
- If you are using a **roasting bag**, follow the instructions on the packaging.
- If you are using the **wire rack** or an **open cooking container** for roasting, you can add a little fat or oil to very lean meat or place a few strips of bacon on the top.
- **Season** the meat and place in the cooking container. Dot with butter or brush with oil or cooking fat. For large lean cuts of meat (4–6 lb/2–3 kg) and fatty poultry, add about 1/2 cup (1/8 liter) of water to the dish.

- Do not add too much liquid during cooking as this will hinder the **browning** process. Browning only occurs towards the end of the cooking duration. Remove the lid about halfway through the cooking duration if you want a more intensive browning result.
- At the end of the program, take the food out of the oven, cover it, and leave to **stand** for about 10 minutes. This helps retain the juices when the meat is sliced.
- For a crisp finish, baste **poultry** 10 minutes before the end of the cooking duration with slightly salted water.

Selecting the temperature

- As a general rule, select the temperature given in the corresponding recipe.
- For large pieces of meat, do not choose a temperature that is too high. The roasting process will take longer, but the meat will cook through evenly and the skin or crackling will not be too thick.
- If the recipe refers to the Surround  operating mode, select a temperature that is approx. 70°F (20°C) lower when using the Convection Bake  operating mode.
- When roasting on the Wire Rack, set a temperature approx. 50°F (10°C) lower than for roasting in a covered cooking container.

Selecting the cooking duration

- Determine the cooking duration by multiplying the thickness of the roast [cm] with the time per cm [min/cm] stated below, depending on the type of meat:
 - beef/venison: 15–18 min/cm
 - pork/veal/lamb: 12–15 min/cm
 - sirloin/fillet: 8–10 min/cm
- Check whether the food is cooked shortly before the end of the specified cooking duration.

Tips

- For frozen meat, increase the cooking duration by approx. 20 minutes per kg.
- Frozen meat weighing less than approx. 3.3 kg (1.5 kg) does not need to be defrosted before roasting.



Notes on the operating modes

A list of all operating modes can be found in “Overview of operating modes”.

Use the Bake  operating mode towards the end of the cooking duration to brown the base of the food.

Using Convection Bake

These operating modes are suitable for roasting meat, fish, and poultry that needs to be well browned, as well as roast beef and fillet.

The Convection Bake  operating mode allows you to use a lower temperature than you would with the Surround  operating mode, because the heat is immediately distributed throughout the oven compartment.

- Place the food on shelf level 3.
- Place large food, e.g., a turkey, on level 1 or 2.

Using Surround

Use this operating mode for cooking traditional recipes. If using an older recipe or cookbook, set the oven temperature 50°F (10°C) lower than that recommended. This will not change the cooking duration.

- Place the food on shelf level 3.
- Place large food, e.g., a turkey, on level 1 or 2.

Broiling

 Risk of injury caused by hot surfaces.

If you broil with the door open, the hot air will escape from the oven before it has been cooled by the cooling fan. The control elements will get hot.

Broil with the oven door closed.

Always observe USDA/CFIA food safety guidelines.

Tips for broiling

- Preheating is necessary when broiling. Preheat the browning/ broiling element for approx. 5 minutes with the door closed.
- Quickly rinse meat under cold running water and pat dry. Do not season the meat with salt before broiling, as this will draw out the juices.
- Add a little oil to lean meat if necessary. Do not use other types of fat as they can easily burn and cause smoke.
- Clean fish in the normal way. To enhance the flavor, season with a little salt. You can also drizzle the fish with lemon juice.
- Use the universal tray with the broiling and roasting insert (if present) on top and place the universal tray on the wire rack.

- The tray under the insert will collect the meat juices and stop them from burning so that they can be used for making gravy and sauces. Brush the wire rack or the broiling and roasting insert with oil and then place the food on top. Using the broiling and roasting insert can reduce the amount of smoke produced.

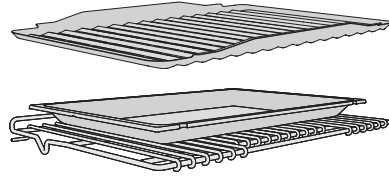

Selecting the temperature

- As a general rule, select the temperature given in the corresponding recipe.
- For large pieces of meat, do not choose a temperature that is too high. The roasting process will take longer, but the meat will cook through evenly and the skin or crackling will not be too thick.

Choosing a shelf level

- Select the shelf level depending on the thickness of the food to be cooked.
- Place flat food on shelf level 4 or 5.
- Place thicker food on shelf level 2 or 3.

Selecting the cooking duration

- Broil thinner cuts of meat/slices of fish for approx. 6–8 minutes per side. It is best to broil food of a similar thickness at the same time so that the cooking durations do not vary too much.
- Check whether the food is cooked shortly before the end of the specified cooking duration.

Tip: If the surface of a thicker cut of meat is browned but the center is still raw, move the food to a lower level or reduce the temperature and continue broiling. This will stop the surface from becoming too dark.

Notes on the operating modes

A list of all operating modes can be found in “Overview of operating modes”.

Using Maxi Broil

Use this operating mode to broil flat thin cuts in large quantities and for browning large baked dishes.

The entire browning/broiling element will become red hot to produce the necessary heat.

Using Convection Broil

This operating mode is suitable for broiling thicker food, such as chicken.

It is generally recommended to use a temperature setting of 425°F (220°C) for thinner types of food and 350–400°F (180–200°C) for thicker cuts.

Further applications

This section provides information on the following applications:

- Defrost
- Dehydrating
- Heating dishware
- Slow Roasting
- Canning
- Frozen food/ready meals

Defrost

Gentle defrosting of frozen food means that the vitamins and minerals are generally retained.

■ Select the Convection

Bake  operating mode without a temperature setting.

Air is circulated throughout the oven compartment to gently defrost the frozen food.

Always observe USDA/CFIA food safety guidelines.

 Risk of infection from bacteria.

Bacteria such as salmonella can cause life-threatening food poisoning.

It is particularly important to observe food hygiene rules when defrosting fish and meat, and in particular when defrosting poultry.

Do not use the liquid produced during defrosting.



Process the food as required as soon as it has been defrosted.

Tips

- Remove the packaging and place the frozen food on the universal tray or in a suitable bowl or dish.
- Use the universal tray with the wire rack placed on top of it for defrosting poultry. This way the food will not be lying in the defrosted liquid.
- Fish does not need to be fully defrosted before cooking. Defrost until the food has started to thaw. The surface will then be sufficiently thawed to take herbs and seasoning.

Defrosting durations

The duration needed for defrosting depends on the type and weight of the frozen food:



Frozen food	 [oz/g]	 [min]
Chicken	28/800	90–120
Meat	17.5/500	60–90
	35/1000	90–120
Sausage	17.5/500	30–50
Fish	35/1000	60–90
Strawberries	10.5/300	30–40
Pound cake	17.5/500	20–30
Bread	17.5/500	30–50

 Weight/ defrosting duration





Dehydrating

Dehydrating or drying is a traditional method of preserving fruit and certain vegetables.

It is important that fruit and vegetables are ripe and not bruised before they are dehydrated.

- Prepare the food for drying by cutting it up, and peeling and coring it if necessary.
- Distribute the food to be dried evenly according to size over the universal tray.
- Select Convection Bake .
- Select the desired temperature.
- Place the universal tray on shelf level 3. When using Convection Bake  you can dehydrate on levels 2+4 at the same time.
- Turn the food to be dried halfway through the dehydrating time.

The drying times are longer for whole or halved food.

Food for drying		🌡️ [°F (°C)]	🕒 [h]
Fruit		140-160 (60-70)	2-8
Vegetables		130-150 (55-65)	4-12
Mushrooms		115-125 (45-50)	5-10

 Operating mode

Convection Bake 

🌡️ Temperature, 🕒 drying time

- Reduce the temperature if condensation begins to form in the oven.

Warm-up Cookware

Use the Convection Bake  operating mode for preheating dishware.

Only preheat heat-resistant dishware.

- Place the Wire Rack on shelf level 1 and place the dishware to be preheated on it. Depending on the size of the dishware, you can also place it on the oven floor and take the side racks out to make more room.
- Select Convection Bake .
- Set the temperature to 120–175°F (50–80°C).

 Danger of burning!

Use pot holders when removing dishware. Condensation may accumulate on the bottom of the dishware.

- Remove the heated dishware from the oven.

Further applications

Slow Roasting

Slow Roasting is ideal for cooking delicate cuts of beef, pork, veal, or lamb to perfection.

Always observe USDA/CFIA food safety guidelines.

First briefly sear the meat on all sides at a high temperature on the cooktop in order to seal it.

Then place the meat in the preheated oven where the low temperature and long cooking duration will cook it to perfection and ensure it is very tender.

The meat will relax. The juices inside will start to circulate evenly throughout the meat to reach the outer layers. This gives very tender and succulent results.

- Only use lean meat which has been correctly seasoned and trimmed. Bones should be removed before cooking.
- For searing, use a suitable cooking oil or fat that can withstand high temperatures (e.g., clarified butter, vegetable oil).
- Do not cover meat during the cooking process.

Cooking takes approx. 2–4 hours depending on the weight and size of the meat and how well you want it cooked.

- As soon as the cooking program has finished, you can carve the meat straight from the oven. It does not need to rest.

- You can leave the meat in the oven to keep warm until you serve it. This will not affect results in any way.
- Serve on preheated plates with very hot sauce or gravy to prevent it cooling down too quickly. The meat is at an ideal temperature to eat straight away.

Using Surround

Use the universal tray with the Wire Rack placed on top of it. Do not use the Booster  operating mode to pre-heat the oven.

- Place the Wire Rack with the universal tray on shelf level 3.
- Select the Surround  operating mode and a temperature of 250°F (120°C).
- Preheat the oven together with the universal tray and Wire Rack for approx. 15 minutes.
- While the oven is preheating, sear the meat on all sides on the cooktop.

 Danger of burning due to hot surfaces.

The oven gets hot during operation. You could burn yourself on the heater elements, oven compartment, or accessories.

Use pot holders when placing food in the appliance or removing it and when working in the hot oven compartment.

- Place the seared meat on the Wire Rack.
- Reduce the temperature to 210°F (100°C).
- Continue cooking the meat until it is done.

Further applications

Cooking durations/core temperatures

Always observe USDA/CFIA food safety guidelines.

Meat	Cooking duration	Core temperature
Beef tenderloin, approx. 2.2 lbs (1 kg)		
- rare	60–80 min	113–119°F (45–48°C)
- medium	75–85 min	129–135°F (54–57°C)
- well done	110–130 min	145–151°F (63–66°C)
Prime rib, approx. 2.2 lbs (1 kg)		
- rare	70–80 min	113–119°F (45–48°C)
- medium	105–115 min	129–135°F (54–57°C)
- well done	130–140 min	145–151°F (63–66°C)
Pork tenderloin, approx. 0.75 lbs (350 g)	70–90 min	145–156°F (63–69°C)
Gammon joint*, approx. 2.2 lbs (1 kg)	140–160 min	145–151°F (63–66°C)
Veal tenderloin, approx. 2.2 lbs (1 kg)		
- pink	45–55 min	113–119°F (45–48°C)
- medium	75–85 min	129–135°F (54–57°C)
- well done	90–100 min	145–151°F (63–66°C)
Saddle of veal*, approx. 2.2 lbs (1 kg)		
- pink	75–85 min	113–119°F (45–48°C)
- medium	100–130 min	129–135°F (54–57°C)
- well done	130–140 min	145–151°F (63–66°C)
Saddle of lamb*	40–60 min	129–151°F (54–66°C)

* Boneless

Further applications

Canning

 Risk of infection from bacteria.

The spores of the botulinum bacterium are not sufficiently killed by canning legumes and meat only once. Toxins may form which can lead to serious poisoning. These spores are only destroyed by canning the food again.

After they have cooled down, **always** reheat legumes and meat a second time within 2 days.

 Risk of injury from increased pressure in sealed cans.

Canning food and heating it up in closed containers results in an increase in pressure which can cause them to explode.

Do not use cans for canning or reheating food.

Always observe USDA/CFIA food safety guidelines.

Preparing fruit and vegetables

The instructions are for 6 jars with a capacity of 1 liter each.

Only use special jars for canning (preserving jars or jars with a screw cap). Only use undamaged jars and rubber rings.

- Rinse the jars with hot water before canning and fill them up to a maximum of 3/4" (2 cm) below the rim.
- Slide the universal tray onto shelf level 3. Place the jars on the tray.
- Select the Convection Bake  operating mode and a temperature of 320-340°F (160-170°C).
- Wait until bubbles rise evenly in the jars.



Then reduce the temperature to prevent the contents from boiling over.

Canning fruit and vegetables

- Set the specified post-canning warming temperature as soon as bubbles are visible in the jars, then leave the jars in the warm oven for the time specified.

Canning vegetables

- As soon as bubbles are visible in the jars, set the specified preserving temperature and cook the vegetables for the time specified.
- After canning, set the specified post-canning warming temperature, then leave the jars in the warm oven for the time specified.

		
Fruit	-/-	85°F (30°C)/ 25–35 min
Pickling cucumbers	-/-	85°F (30°C)/ 25–30 min
Beets	250°F (120°C)/ 30–40 min	85°F (30°C)/ 25–30 min
Beans (green or yellow)	250°F (120°C)/ 90–120 min	85°F (30°C)/ 25–30 min

 Canning temperature and time once bubbles are visible in the jars

 Post-canning warming temperature and time

Removing the jars after canning

 Risk of injury caused by hot surfaces.

The jars will be very hot after canning.

Use oven mitts when removing the jars from the oven.

- Take the jars out of the oven.
- Cover the jars with a towel and leave to set for approx. 24 hours in a draft-free area.
- After they have cooled down, **always** reheat beans and meat a second time within 2 days.
- Remove the fasteners from the jars and make sure all jars are closed properly when storing them.

Either boil open jars again or store them in a cool place and consume the preserved fruit or vegetables immediately.

- Check the jars during storage. If jars have opened during storage or if the screw cap is bulging and does not make a popping noise when opened, dispose of the contents.

Further applications

Frozen food/ready meals

Tips for cakes, pizza, and baguettes

- Bake cakes, pizza, and baguettes on parchment paper on the wire rack.
- Use the lowest temperature recommended by the manufacturer.

Tips for French fries, croquettes, and similar items

- Cook frozen food items on parchment paper placed on a baking tray or the universal tray.
- Use the lowest temperature recommended by the manufacturer.
- Turn several times during cooking.

Preparing frozen food/ready meals

Handling and cooking food correctly is essential for maintaining good health.

Cakes, pizzas, and French fries should be cooked until golden, not dark brown.

- Select the operating mode and temperatures recommended on the food's packaging.
- Preheat the oven.
- Place the food in the preheated oven on the shelf level recommended on the packaging.
- Check the food at the end of the shortest time recommended on the packaging.

Cleaning and care of the oven

 Risk of injury caused by hot surfaces.

The oven gets hot during operation. You could burn yourself on the heating elements, oven compartment, or accessories. Allow the heating elements, oven compartment, and accessories to cool before manual cleaning.

 Risk of injury due to electric shock.

The steam from a steam cleaning appliance could reach live electrical components and cause a short circuit. Never use a steam cleaner for cleaning.

All surfaces could be discolored or damaged if unsuitable cleaning agents are used. The oven front is particularly susceptible to damage from oven cleaners or descaling agents.

All surfaces are susceptible to scratching. Scratches on glass can lead to breakage in some circumstances.

Remove all cleaning agent residues immediately.

- Abrasive cleaning agents (e.g., powder cleaners and cream cleaners)
- Solvent-based cleaning agents
- Stainless steel cleaning agents
- Dishwasher cleaner
- Glass cleaners
- Cleaning agents for ceramic cooktops
- Hard, abrasive brushes or sponges (e.g., pot scourers, brushes, or sponges which have been previously used with abrasive cleaning agents)
- Eraser sponges
- Sharp metal scrapers
- Steel wool
- Spot cleaning with mechanical cleaning agents
- Oven cleaners
- Stainless-steel spiral pads

If soiling is allowed to sit for any length of time, it may become impossible to remove. If items are used frequently without being cleaned, it may become very difficult to clean them. It is therefore best to remove any soiling immediately.

The accessories are not dishwasher-safe.

Unsuitable cleaning agents

To avoid damaging the surfaces of your appliance, do not use:

- Cleaning agents containing soda, ammonia, acids, or chlorides
- Cleaning agents containing descaling agents on the front

Tip: Soiling caused by spilled fruit juices and cake mixtures is best removed while the oven is still warm. Use caution and make sure the oven is not too hot.

To make it easier to clean the oven:

- Remove the door.
- Remove the side racks.

Cleaning and care of the oven

Removing normal soiling

There is a fiberglass seal around the oven compartment which seals the inside of the glass oven door and can be damaged by rubbing and scouring.

Avoid cleaning the fiberglass seal. The fiberglass seal is essential for sealing the door properly.

- Remove normal soiling immediately with warm water, liquid dish soap, and a clean sponge or a clean, damp microfiber cloth.
- Remove all cleaning agent residues thoroughly with clean water. This is particularly important for any parts with a PerfectClean finish, as cleaning agent residues will impair the non-stick function.
- After cleaning, wipe the surfaces dry using a soft cloth.

Removing stubborn soiling

Do not line the oven (e.g., with aluminum foil) and do not use standard oven cleaners unless they are suitable for use in a self-cleaning oven.

Spilt fruit and roasting juices may cause lasting discoloration or matte patches on surfaces. This discoloration will not affect the properties of the surface finish.

Do not attempt to remove these marks. Clean them following the instructions given here.

- Baked-on deposits can be removed with a glass scraper or with a stainless-steel spiral pad, hot water, and liquid dish soap.

You do not need to treat the oven compartment with an oven cleaner as the oven comes with  Self Clean.

- If necessary, you can use the scouring pad on the back of a non-scratching dish sponge to remove the soiling after the holding time.
- Remove all cleaning agent residues thoroughly with clean water.
- Dry all surfaces with a soft cloth.

Cleaning the oven compartment with Self clean

Instead of cleaning the oven manually you can use the Self clean  operating mode.

During the Self Clean function, the oven compartment reaches temperatures in excess of 750°F (400°C). Any grime that has accumulated will be broken down and burnt to ash as a result of the high temperatures.

There are 3 Self Clean settings available, each with a different duration:

- Level 1 for light soiling
- Level 2 for heavier soiling
- Level 3 for very heavy soiling

The oven door is automatically locked when the Self Clean process starts. It cannot be opened until after the program has finished.

Cleaning and care of the oven

The timer can be used to delay the start time of the Self Clean program.

At the end of the Self Clean program, any residues such as ash from the cleaning process, which are formed depending on the oven compartment's degree of soiling, can be easily wiped away.

Preparing for Self Clean

Accessories will be damaged by the high temperatures during the Self Clean program.

Remove all accessories from the oven compartment before starting the Self Clean program. This also applies to the side racks and any optional accessories.

Coarse soiling in the oven compartment can cause thick smoke to develop.

Burnt-on residues can cause lasting discoloration or matte spots on enameled surfaces.

Before starting the Self Clean program, remove coarse soiling from the oven compartment and scrape any burnt-on residues off enameled surfaces with a glass scraper.

- Remove all accessories from the oven compartment (including the side racks).

Starting Self Clean

 **Danger of burning!**
The front of the oven gets hotter in the Self Clean program than it does in normal oven modes.

Do not let children touch the appliance during the Self Clean program.

- Select the Self clean  operating mode.



PY 1 appears. The number will flash.



Use < or > to choose between the *PY 1*, *PY 2*, and *PY 3* Self Clean levels.

- Select the desired Self Clean level.
- Confirm with **OK**.

The Self Clean program will start.

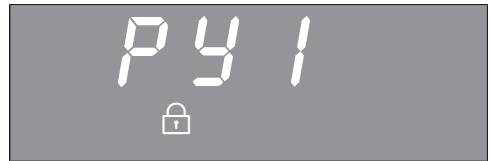
 will also appear in the display.





While  is flashing, the door is locked automatically.  lights up as long as it is locked.

The oven heating and the cooling fan will then turn on automatically.

The oven interior lighting will not come on during the Self Clean program.

Cleaning and care of the oven

If you want to see how the Self Clean program is progressing, you need to highlight the duration symbol  in the display.

- Select *OK*.
- If necessary, use < or > to move the triangle ▲ until it appears under .

The time left for the Self Clean program will start counting down on the display. You cannot alter the duration.

You can use the timer while the Self Clean program is running. When the set time has elapsed, the audible signal will sound and  will flash. The time will then continue to increase on the display. The audible signal will stop and the symbols in the display will go out as soon as you confirm with *OK*. *Py* and the number of the selected Self Clean program will appear again.

Starting Self Clean at a later time

Start the Self Clean program as described above and then set the required finish time within the first five minutes of starting the program.

- Select *OK*.
- Move the triangle ▲ with < or > until it appears under .

:-:- appears.

- Confirm with *OK*.

The display will show the finish time calculated from the current time of day plus the duration of the selected Self Clean program.

- Set the desired finish time using < or >.

- Confirm with *OK*.

The finish time is now saved.

The oven heating switches off.



The finish time can be changed at any time up until the start time for the program.

As soon as the start time is reached, the oven heating and the cooling fan will switch on. The duration will appear in the display.



At the end of the Self Clean program



0:00, , and  will appear in the display.

As long as  lights up, the door is locked. When  flashes, the door is unlocked.

When the door lock has been deactivated:

-  goes out.
 -  flashes.
 - Short signals will sound if the audible signal is switched on.
- Turn the mode selector to *Off*.

The audible signal will stop and the symbols on the display will go out.

Cleaning and care of the oven

 Danger of injury caused by hot surfaces.

At the end of the Self Clean program, the oven will still be very hot. You could burn yourself on the heater elements and the oven compartment.

Allow the heating elements and the oven compartment temperature to drop to a safe level before removing any residues.

- Clean the oven compartment to remove any Self Clean residues (e.g., ash) that can build up depending on the degree of soiling in the oven compartment.

Most residues can be removed with warm water, liquid dish soap, and a clean sponge or a clean, damp microfiber cloth.



Depending on how dirty the oven was prior to cleaning, there may be a visible layer of soiling across the inner glass pane on the door. You can remove this using the scouring side of a dish sponge, a glass scraper, or with a stainless steel spiral pad and liquid dish soap.

Please note:







- There is a fiberglass seal around the oven compartment which seals the inside of the glass oven door and can be damaged by rubbing and scouring. Do not clean the door seal – it is essential for sealing the door properly.

- Spilled fruit juices may cause lasting discoloration of enameled surfaces. This discoloration is permanent but will not affect the properties of the enamel. Do not attempt to remove these stains.

Self Clean interrupted

If the Self Clean program is canceled, the oven door will remain locked until the temperature inside the oven drops to below 535°F (280°C).  remains lit up until the temperature of the oven compartment has fallen below this temperature. When  flashes, the door is unlocked.

The following events will cause the Self Clean program to stop:

- The mode selector is turned to *Off*.
Once the door has been unlocked,  will go out and the time of day will appear. Start the Self Clean program again if necessary.
- The mode selector is turned to a different operating mode.
Py and  appear. Once the door has been unlocked,  will go out and *Py* will flash. Start the Self Clean program again if necessary.
- A power failure occurs.
Py and  appear. Once the door has been unlocked,  will go out and *Py* will flash.
When power is restored, *Py* remains lit up until the temperature of the oven compartment has fallen below 535°F (280°C).  will then appear. The door is unlocked and the time of day will appear.

Cleaning and care of the oven

Removing the door

The door weighs approx. 36 lbs (16 kg).

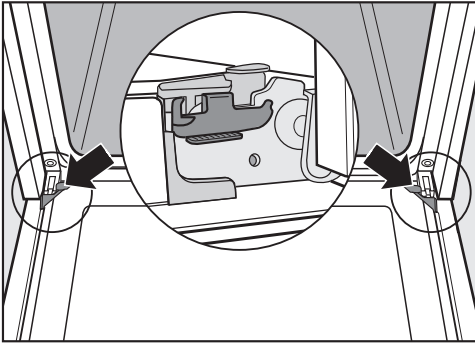

The oven door is connected to the hinges by retainers. Before removing the door from the retainers, the locking clamps on both hinges have to be released.

- Open the door fully.

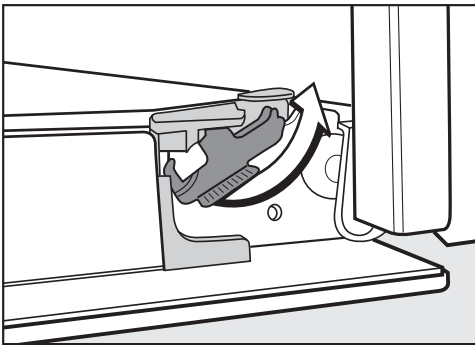

- Release the locking clamps by turning them as far as they will go.

You could damage the oven if you remove the door incorrectly. Do not pull the door horizontally off its retainers, as they will spring back against the oven. Do not pull the door off the retainers by the handle, as the handle could break off.

- Raise the door up till it rests partially open.



- Hold the door on either side and pull it upwards off the hinge retainers. Make sure that the door is straight.

Cleaning and care of the oven

Installing the door

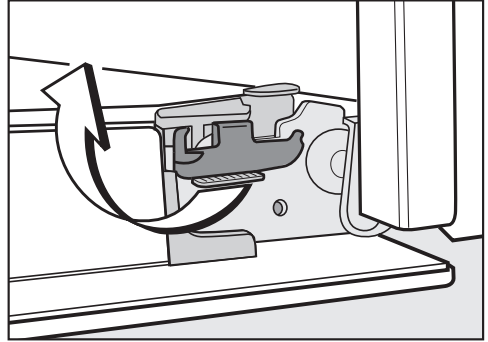
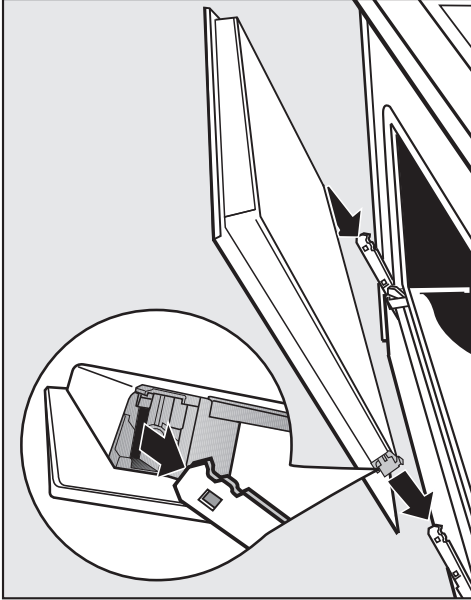

- To relock the locking clamps, turn them back up to the horizontal position as far as they will go.

- Hold the door securely on both sides and carefully install it back into the hinge retainers. Make sure that you do not tilt the door.
- Open the door fully.

If the locking clamps are not locked, the door could become loose, resulting in damage.

Ensure that the locking clamps are locked after reinstalling the door.

Cleaning and care of the oven

Side rack removal

 Danger of injury caused by hot surfaces.

The oven gets hot during operation. You could burn yourself on the heater elements, oven compartment, or accessories.

Allow the heating elements, oven compartment, and accessories to cool before removing the side racks.

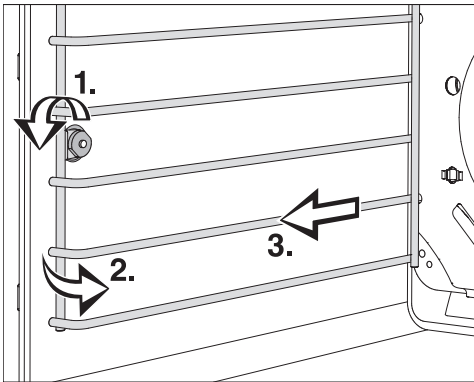

- Loosen the knurled screw (1.).
- Pull the side racks forwards out of the holder (2.).
- Remove the side racks (3.).



Reinstall by following these instructions in reverse order.

- Insert the components carefully.

Frequently Asked Questions

With the help of the following guide minor faults in the performance of the machine, some of which may result from incorrect operation, can be remedied without contacting the Service Department.

This guide may help you to find the reason for the fault, and how to correct it.

Problem	Possible cause and solution
The display is dark.	<p>There is no power to the oven.</p> <ul style="list-style-type: none"> ■ Check if the breaker has tripped. If it has, contact a qualified electrician or Miele Customer Service.
The oven does not heat up.	<p>You have only selected an operating mode or a temperature.</p> <ul style="list-style-type: none"> ■ Select both a mode and a temperature. <p>The system lock  is activated.</p> <ul style="list-style-type: none"> ■ Switch the system lock off (see “Using the oven – Operating the clock/timer”). <p>There is no power to the oven.</p> <ul style="list-style-type: none"> ■ Check if the breaker has tripped. If it has, contact a qualified electrician or Miele Customer Service. <p>Demo mode is activated. <i>DEMO</i> appears. The oven can be operated, however the heating elements will not work.</p> <ul style="list-style-type: none"> ■ Deactivate demo mode (see “Using the oven – Operating the clock/timer”).
12:00 is flashing in the display.	<p>There has been a power failure.</p> <ul style="list-style-type: none"> ■ Reset the time of day (see “Before using for the first time”). <p>Cooking times will also need to be reset.</p>
0:00 appears unexpectedly in the display and  is flashing at the same time. The audible signal might also be sounding.	<p>The oven has been operating for an unusually long period of time, and this has activated the safety shut-off.</p> <ul style="list-style-type: none"> ■ Turn the mode selector to <i>Off</i>. The oven is ready for use again immediately.

Frequently Asked Questions

Problem	Possible cause and solution
F 32 appears on the display.	The door lock for the Self Clean program has not locked. ■ Turn the mode selector to <i>Off</i> and select the Self Clean program again. If the problem persists, contact Miele Customer Service.
F 33 appears on the display.	The door lock for the Self Clean program has not opened. ■ Turn the mode selector to <i>Off</i> and switch the oven off. If the problem persists, contact Miele Customer Service.
F and a fault code not listed here appear on the display.	A fault has occurred that you cannot resolve. ■ Contact Miele Customer Service.
A noise is heard after the cooking process is complete.	After the cooking process the cooling fan will continue to run for a while after a program is complete to prevent moisture from building up in the oven, on the control panel or surrounding cabinetry. The cooling fan will turn off automatically.
The oven has turned itself off.	To save power, the oven turns off automatically if a button is not pressed after a certain amount of time or after a cooking program has ended. ■ Turn the oven back on.
The oven interior lighting turns off after a short time.	The oven lighting is set to switch off after 15 seconds (default setting). You can change this setting (see “Using the oven – Operating the clock/timer”).

Frequently Asked Questions

Problem	Possible cause and solution
The cake/cookies are not baked properly.	<p>A different temperature than that given in the recipe was used.</p> <ul style="list-style-type: none"> ■ Select the temperature required for the recipe.
	<p>The ingredient quantities are different from those given in the recipe.</p> <ul style="list-style-type: none"> ■ Check if you have amended the recipe. The addition of more liquid or more eggs will make a wetter mixture which will take longer to cook.
The browning of cakes/cookies is uneven.	<p>The wrong temperature or shelf level was selected.</p> <ul style="list-style-type: none"> ■ There will always be a slight unevenness. If browning is very uneven, check whether you selected the correct temperature and shelf level.
	<p>The material or color of the bakeware is not suitable for the operating mode selected.</p> <ul style="list-style-type: none"> ■ When using the Surround  operating mode, light-colored, shiny baking pans will not produce as desirable results. Dark, matte baking pans are best for baking.
There is still soiling in the oven compartment after a Self Clean program.	<p>The Self Clean program burns off soiling in the oven and leaves it as ash.</p> <ul style="list-style-type: none"> ■ Remove the ash with warm water, liquid dish soap, and a clean sponge or a clean, damp microfiber cloth. <p>If there is still coarse soiling left in the oven after the Self Clean program, you should start the program again, selecting a longer duration if necessary.</p>

Frequently Asked Questions

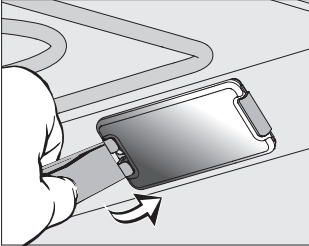
Problem	Possible cause and solution
<p data-bbox="76 204 365 261">The oven interior lighting does not turn on.</p>  An illustration showing a hand holding a rectangular lamp cover. The cover is being moved away from the oven's interior, as indicated by a curved arrow pointing to the right. The background shows the interior of an oven with a curved top edge.	<p data-bbox="400 204 721 229">The halogen lamp is faulty.</p> <div data-bbox="407 240 1042 464" style="border: 1px solid gray; padding: 5px;"><p data-bbox="415 252 949 284">⚠ Danger of injury caused by hot surfaces.</p><p data-bbox="415 293 969 379">The oven gets hot during operation. You could burn yourself on the heater elements, oven compartment, or accessories.</p><p data-bbox="415 389 1028 446">Allow the heater elements, oven compartment, and accessories to cool before manual cleaning.</p></div> <div data-bbox="407 485 1042 628" style="border: 1px solid gray; padding: 5px;"><p data-bbox="415 491 997 517">The lamp cover may be damaged if it falls down.</p><p data-bbox="415 526 990 612">Hold onto the lamp cover while removing it so it does not fall down. Place a cloth over the oven floor to protect it and the open door.</p></div> <ul data-bbox="400 651 1001 1038" style="list-style-type: none"><li data-bbox="400 651 1001 708">■ Disconnect the oven from the electrical supply. Unplug the appliance or switch off the breaker.<li data-bbox="400 718 1001 775">■ Remove the lamp cover from the frame from behind with the tool supplied.<li data-bbox="400 785 1001 906">■ Do not grasp the halogen lamp with your bare fingers. Please follow the manufacturer's instructions. Remove the halogen lamp.<li data-bbox="400 916 1001 973">■ Replace the halogen lamp (Osram 66725 AM/A, 230 V, 25 W, G9).<li data-bbox="400 983 1001 1008">■ Press the lamp cover back into place.<li data-bbox="400 1018 1001 1043">■ Reconnect the oven to the electrical supply.

Contact in the event of a fault

In the event of a fault which you cannot remedy yourself, please contact your Miele dealer or Miele Customer Service.

You can book a Miele Service Call online at www.miele.com/service.

Contact information for Miele Customer Service can be found at the end of this document.

Please quote the model identifier and serial number of your appliance (SN) when contacting Miele Customer Service. Both pieces of information can be found on the data plate.

This information is given on the data plate, visible on the front frame of the oven, with the door fully open.

Appliance warranty and product registration

You can register your product and/or view the manufacturer's warranty terms and conditions for Miele appliances and vacuum cleaners at www.mieleusa.com.

Caring for the environment

Disposal of the packing material

The cardboard box and packing materials protect the appliance during shipping. They have been designed to be biodegradable and recyclable.

Ensure that any plastic wrappings, bags, etc. are disposed of safely and kept out of the reach of children.
Danger of suffocation!

Disposal of your old appliance

Electrical and electronic appliances contain valuable materials. They also contain certain substances, compounds and components which were essential for the proper functioning and safe use of the equipment. Handling these materials improperly by disposing of them in your household waste can be harmful to your health and the environment. Therefore, please do not dispose of your old appliance with regular household waste and follow local regulations on proper disposal.



Consult with local authorities, dealers or Miele in order to dispose of and recycle electrical and electronic appliances. Miele assumes no responsibility for deleting any personal data left on the appliance being disposed. Please ensure that your old appliance is kept away from children until removal. Observe safety requirements for appliances that may tip over or pose an entrapment hazard.

Installation dimensions

Installation in a tall or base cabinet

Miele Ovens can be installed flush or proud. Discuss your requirements with your architect, kitchen designer, and installer.

More installation drawings are available on the Miele website.

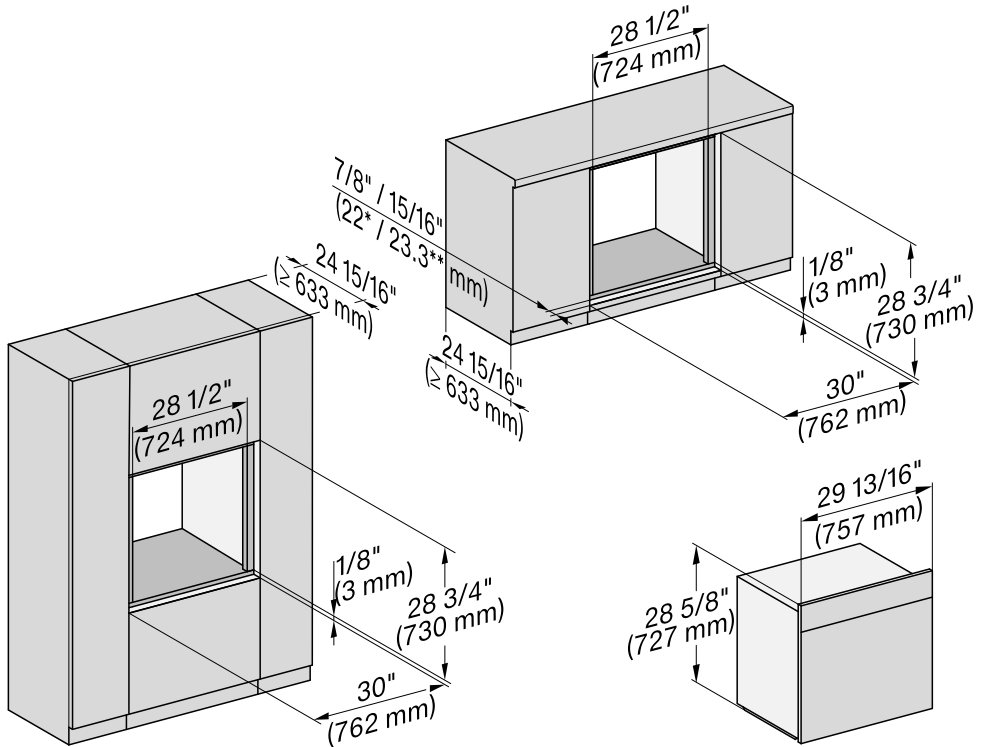

* Oven with glass front

** Oven with metal front

Installation

Side view

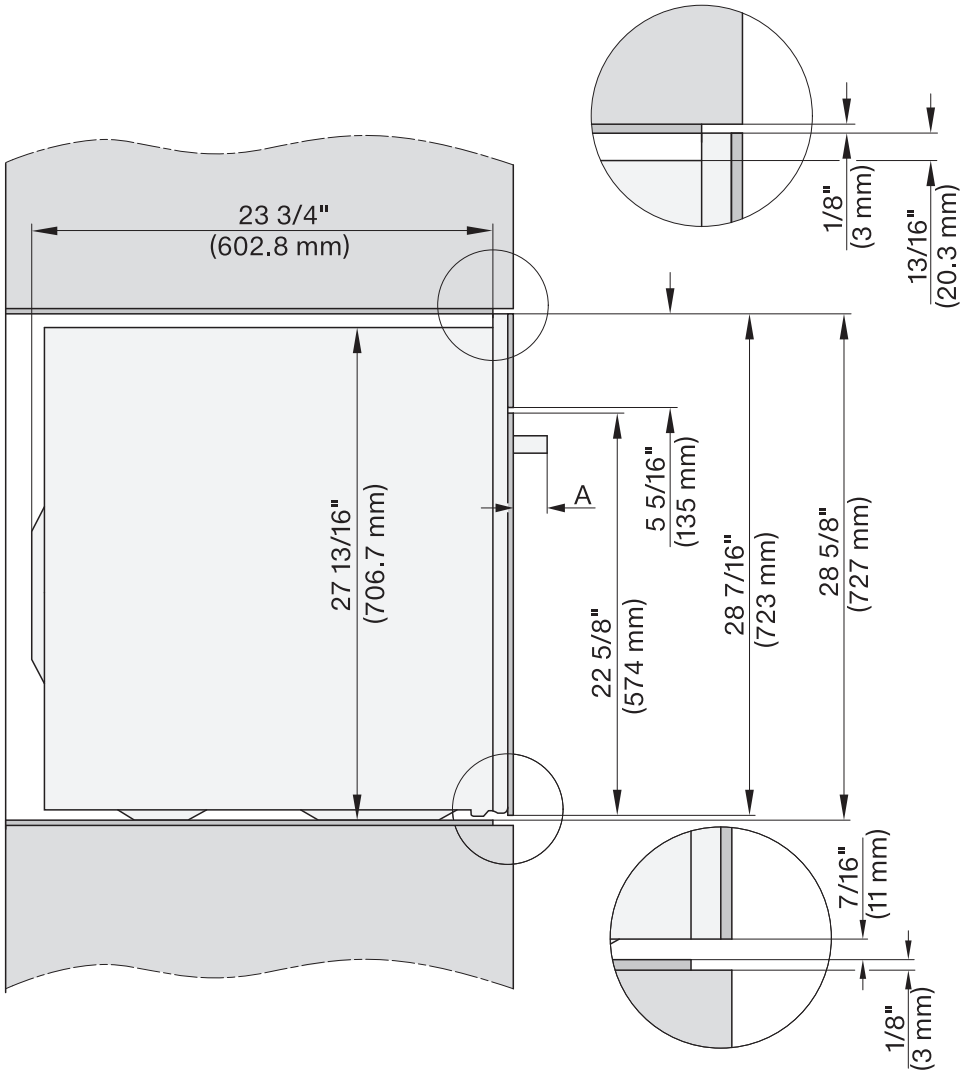

- A** H 25xx, H 27xx: 2 1/2" (64 mm)
H 28xx: 1 7/8" (47 mm)

Connections and ventilation

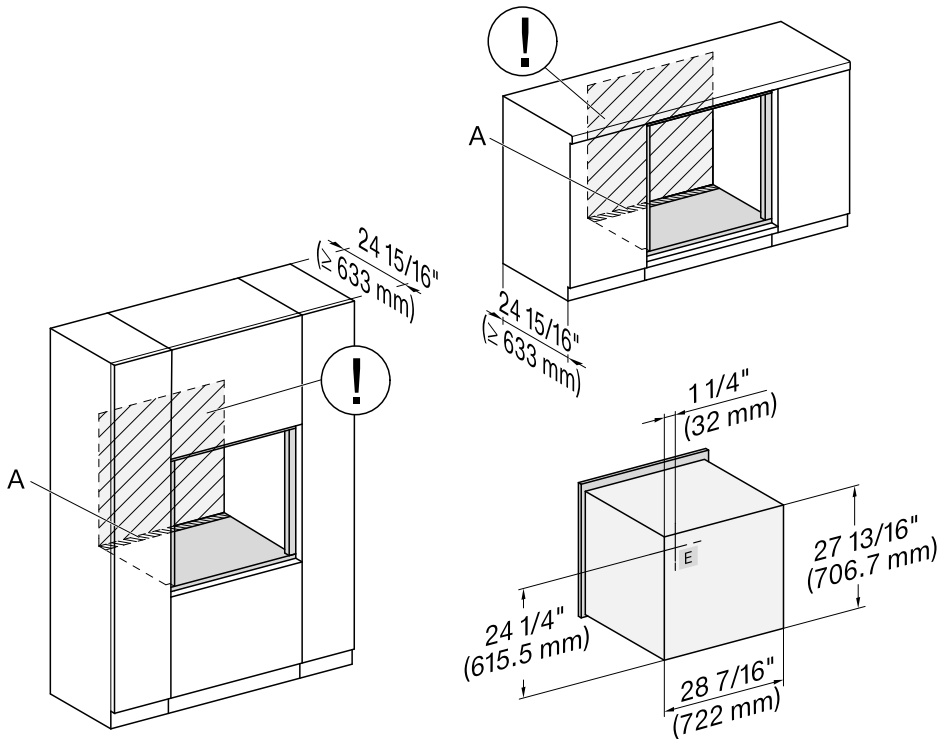

- A** Cutout $4" \times 28 \frac{3}{8}"$ ($100 \text{ mm} \times 720 \text{ mm}$) in the base of the kitchen cabinet for power cord and ventilation
- ⓘ The outlet for the electrical connection should be accessible, e.g., in an adjacent kitchen cabinet. If the electrical connection is behind the oven, the kitchen cabinet needs to be deeper than specified.
- E** Electrical connection

Installation

Installing and removing the oven

For safety reasons, only use the oven when it has been fully installed.

The oven requires a sufficient supply of cool air for efficient operation. The required supply of cool air must not be excessively heated by other heat sources (e.g., wood burning stoves).

The following must be observed when installing the appliance:
Make sure that the shelf that the oven sits on does not touch the wall.
Do not install heat insulation strips on the side walls of the cabinet carcass.

Securing the oven in the housing unit

- Connect the oven to the power supply.

Do not carry the oven by the door handle. This could damage the door. Use the carry handles on the side of the housing to lift the appliance.

It is a good idea to remove the door (see “Cleaning and care – Removing the door”) and the accessories before installing the oven. The oven is then easier to push into the housing unit and you do not run the risk of lifting it by the door handle.

- Push the oven into the housing unit far enough for you to be able to remove the carry handles.

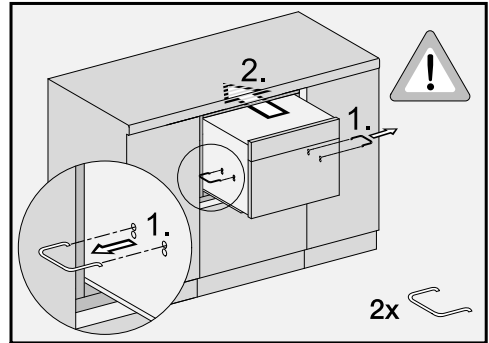

- Remove the carry handles (1.). Keep the carry handles in case the oven needs to be moved again in the future.
- Push the oven all the way into the housing unit and align it in the center of the unit (2.).
- Open the door if you have not removed it.

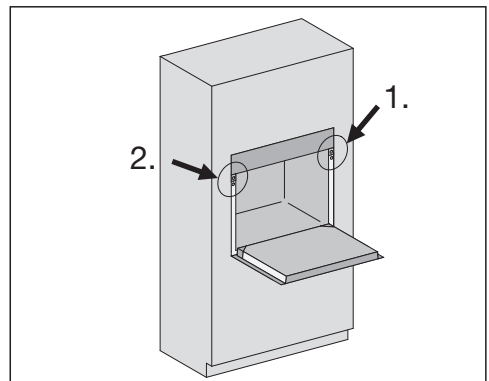

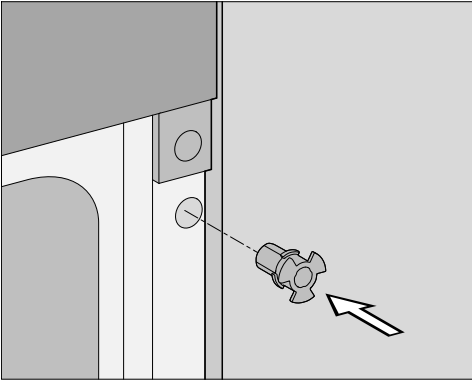

- Insert the mounting aid into the hole in the front frame.

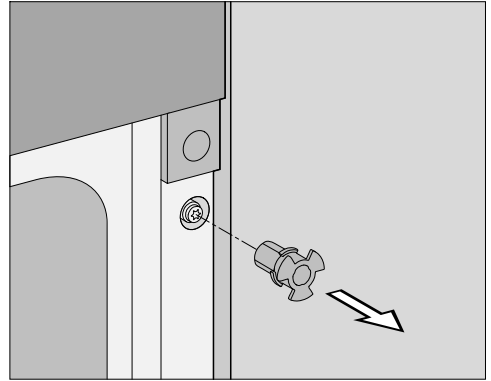

- Remove the mounting aid.

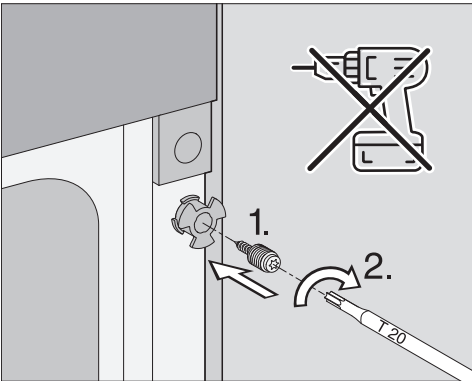

- Insert the bolt into the mounting aid and tighten it in the cabinet niche. **Do not** use a cordless screwdriver.

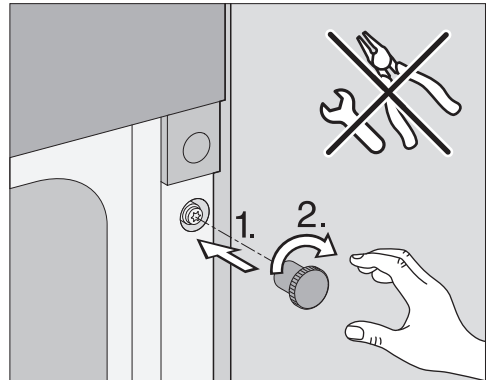

- Screw the knurled nut onto the bolt by hand to fix the oven in the cabinet niche.

The door may be damaged if the knurled nuts protrude from the front frame.

Make sure that the knurled nuts are flush with the front frame after installation.

- Repeat this process for the other side.

Reinstall the door, if necessary (see “Cleaning and care of the oven – Installing the door”).

Installation

Taking the oven out of the housing unit

- Open the door.
- Unscrew the knurled nuts and bolts from the front frame (see “Securing the oven in the housing unit”). Keep these parts in case the oven needs to be installed again in the future.

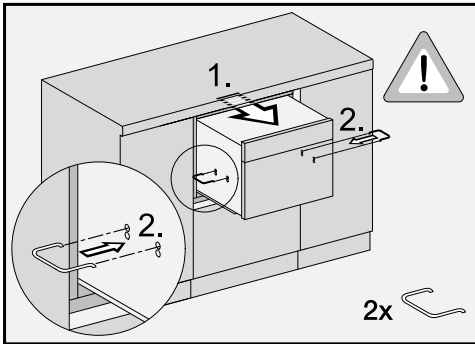

- Pull the oven out of the housing unit until the holes for the carry handles are visible (1.).
- Insert the carry handles into the holes at the top of the side walls on each side of the oven (2.).

Do not carry the oven by the door handle. This could damage the door. Use the carry handles on the side of the housing to lift the appliance.

- Take the oven out of the housing unit.
- Disconnect the oven from the power supply.

Electrical connection

 Risk of injury due to electric shock.

During installation, maintenance, and repair work, the oven must be completely disconnected from the power supply:

Disconnect the oven from the power supply by tripping the breakers, or unplugging the power cord from the outlet. To do this, pull the plug not the cord.

 Risk of injury.

Installation, repairs, and other work by unqualified persons could be dangerous. Miele cannot be held liable for unauthorized work.

Installation, maintenance, and repairs must only be carried out by a Miele authorized technician.

The connection data (voltage and frequency) on the data plate of the oven must match the power supply in order to avoid the risk of damage to the oven.

Compare this before connecting the appliance to the power supply. If in any doubt, consult a qualified electrician.

For safety reasons, the oven may only be used when it has been fully installed.

The power cord plug must be inserted into a suitable outlet that has been installed and grounded in compliance with all applicable local codes.

WARNING: THIS APPLIANCE MUST BE GROUNDED

Installer: Please pass these instructions on to the customer.

Installation

Electrical connection

The oven is equipped with a power cord approx. 6 ft (1.8 m) long with a 4-pin NEMA 14-30P plug for connection to a power supply with:

- 2NAC 208 V, 30 A, 60 Hz
- or
- 2NAC 240 V, 30 A, 60 Hz

Temporary or permanent operation on an autonomous power supply system or a power supply system that is not synchronized with the grid power supply (e.g., island networks, back-up systems) is possible. A prerequisite for operation is that the power supply system complies with the specifications of EN 50160 or an equivalent standard. The function and operation of the protective measures provided in the domestic electrical installation and in this Miele product must also be maintained in isolated operation or in operation that is not synchronized with the grid power supply, or these measures must be replaced by equivalent measures in the installation. As described, for example, in the current version of VDE-AR-E 2510-2.

The voltage can be adjusted via setting *P 9*.

KEEP THE OPERATING AND INSTALLATION INSTRUCTIONS IN A SAFE PLACE.

**Please have the model and serial number
of your appliance available when
contacting Customer Service.**

U.S.A.

Miele, Inc.

National Headquarters

9 Independence Way
Princeton, NJ 08540
www.mieleusa.com

Customer Support

Phone: 888-99-MIELE (64353)
info@mieleusa.com

International Headquarters

Miele & Cie. KG
Carl-Miele-Straße 29
33332 Gütersloh
Germany

Canada

**Importer
Miele Limited**

Headquarters and Miele Centre

161 Four Valley Drive
Vaughan, ON L4K 4V8
www.miele.ca

Customer Care Centre

Phone: 1-800-565-6435
905-532-2272
customercare@miele.ca

H 2780 BP, H 2880 BP

en-US, CA

M.-Nr. 11 919 400 / 01