







Thank you for purchasing this quality product. Be sure to unpack carefully looking for small parts which may have come loose during shipment.

Read all instruction and study the drawing carefully before starting the assembly process.

HARDWARE PACK					PART LIST			
NO.	DRAWING	DESCRIPTION	SIZE	Q'TY	NO.	DRAWING	DESCRIPTION	Q'TY
A		Allen Wrench	73x29x5mm	1 PC	1		Case Body	1 PC
B		Bolt	$\frac{5}{16}$ "	8 PCS				
C		Lock Washer	$\frac{5}{16}$ "	8 PCS				
D		Flat Washer	$\frac{5}{16}$ "	8 PCS	2		Leg	4 PCS
E		Anti - Tip Kit		1 PC				

**Note: The legs (2) are packed in the inner box and tied on the top center drawer. Please follow numbers on legs and corner blocks when assembling legs to the drawer chest.**

### Tipping Restraint

Anti-tip kit is included for use. We recommend installing for safety reason.

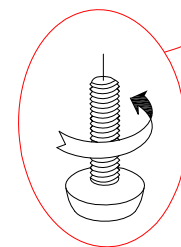
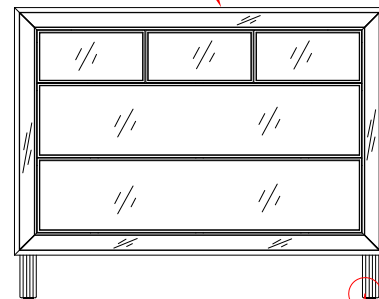
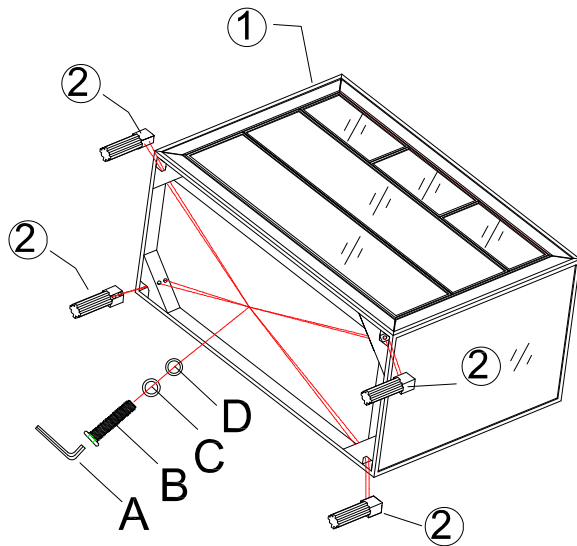
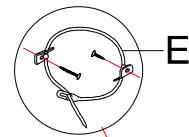

Adjust leveler if needed to level the chest on uneven floor.