

Description

The Crestron® 1-Feed, 4-Dimmer Terminal Block and Module (CLT-1DIMU4 and CLX-1DIMU4) and 2-Feed, 8-Dimmer Terminal Block and Module (CLT-2DIMU8 and CLX-2DIMU8) are all considered single entities and must be used together. They ship separately to permit termination of the field wiring to the terminal block (CLT) prior to installation of the module (CLX). The terminal block is designed to terminate the circuit feed (LINE and NEUTRAL) and distribute the controlled circuit (LOAD) to the fixtures. The module connects to the terminal block and performs dimming control of LED, incandescent, magnetic low-voltage, electronic low-voltage, or dimmable 2-wire fluorescent lighting loads.

The maximum load is 4 A per channel; the maximum load is 16 A total for the CLX-1DIMU4 and 32 A total for the CLX-2DIMU8. The CLX-2DIMU8 accepts two 16 A feeds that can be different phases.

An oversize heat sink dissipates heat efficiently. There are LEDs on the module to indicate communication to a Cresnet® network, input power to the module, and output power to the load.

CLT-1DIMU4/CLT-2DIMU8/CLX-1DIMU4/CLX-2DIMU8 Specifications

| SPECIFICATION | DETAILS |
|---------------------------|--|
| Load Ratings | |
| Dimmers | |
| CLX-1DIMU4 | 4 channels |
| CLX-2DIMU8 | 8 channels |
| Per Channel | 4 A (480 W) |
| Per Group for CLX-2DIMU8 | Channels 1-4: 16 A (1,920 W) Channels 5-8: 16 A (1,920 W) |
| Module Total | |
| CLX-1DIMU4 | 16 A (1,920 W)* |
| CLX-2DIMU8 | 32 A (3,840 W)* |
| Minimum Load | 0 W |
| Dimming Modes | Auto-load detection, forced reverse-phase, forced forward-phase |
| Load Types | LED, incandescent, magnetic low-voltage, electronic low-voltage, 2-wire fluorescent, non-dimmable lighting |
| Power Requirements | |
| CLX-1DIMU4 | 120 Vac, 50/60 Hz, single-phase, 16 A maximum |
| CLX-2DIMU8 | One or two feeds (the same or different phases); 120 Vac, 50/60 Hz, single-phase, 16 A maximum per feed |
| Environmental | |
| Temperature | 32° to 104 °F (0° to 40 °C) |
| Humidity | 10% to 90% RH (noncondensing) |
| Heat Dissipation | |
| CLX-1DIMU4 | 8.5 Btu/hr + (3.41 Btu /Hr x Load Current in A), 63 Btu/hr at maximum load |
| CLX-2DIMU8 | 12 Btu/hr + (3.41 Btu /hr x Load Current in A), 121 Btu/hr at maximum load |
| Enclosure | Gray metal with black heat sink, surface mount module with (2) integral mounting flanges. Occupies 1 module space in a CAEN or CAEN-MLO enclosure |

* When connecting to a third-party arc fault breaker, ensure that the total load does not exceed 1,000 W per feed.

CLT-1DIMU4 Terminal Block with Left-Side CLX-1DIMU4 Labels (Right-Side Not Shown)

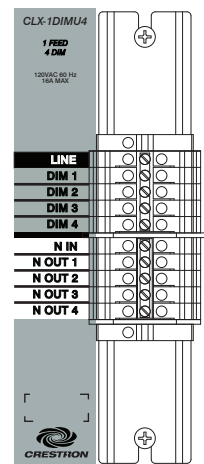

CLX-1DIMU4 Module (Connects to a CLT-1DIMU4)

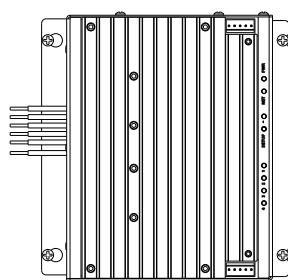

CLT-2DIMU8 Terminal Block with Right-Side CLX-2DIMU8 Labels (Left-Side Not Shown)

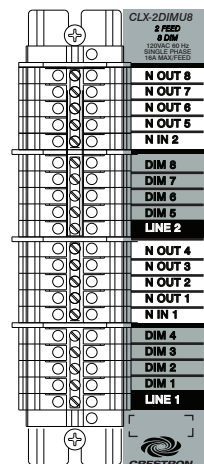

CLX-2DIMU8 Module (Connects to a CLT-2DIMU8)

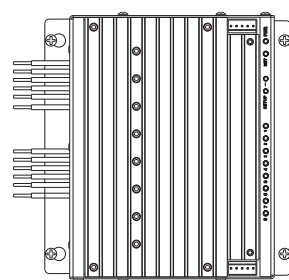

Additional Resources

Visit the product page on the Crestron website (www.crestron.com) for additional information and the latest firmware updates.



Installation

A licensed electrician must mount the terminal block and module into a Crestron Automation Enclosure in accordance with all national and local codes.

CAUTION: This equipment is for indoor use only and needs to be air cooled. Mount in a well-ventilated area. The ambient temperature must be 32° to 104 °F (0° to 40 °C). The relative humidity must be 10% to 90% (noncondensing).

NOTE: For 2-feed systems, the two input lines can be different phases.

NOTE: When connecting to an arc fault breaker, ensure the load does not exceed 1,000 watts total. Crestron certified breakers have a 2,000 watt limit.

IMPORTANT NOTES: When controlling magnetic low voltage transformers.:

- Do not use a CLX-1DIMU4 or CLX-2DIMU8 module for switching or dimming large magnetic transformers (>100 VA).
- Do not connect more than eight magnetic transformers on any one output, regardless of lamp wattage.
- Do not hot plug transformers, or add or remove bypass jumpers while the output channel is energized.
- Do not mix magnetic and electronic transformers on the same output channel.

Failure to follow guidelines above can lead to damage of the dimmer module and transformers.

NOTE: Before using the CLX-1DIMU4 or CLX-2DIMU8, ensure the device is using the latest firmware. Check for the latest firmware for the CLX-1DIMU4 or CLX-2DIMU8 at www.crestron.com/firmware. Load the firmware onto the device using Crestron Toolbox™ software.

Install terminal blocks along the left side of single-wide enclosures and along the outside edges (left and right sides) of double-wide enclosures. Install modules along the right side of single-wide enclosures and side-by-side in the center of double-wide enclosures. When installing modules and terminal blocks in a double-wide enclosure, be sure to invert the units on the right side so that they can be properly wired. Refer to the illustrations that follow when considering the location of terminal blocks and modules within an enclosure.

NOTE: Modules and terminal blocks must be installed into the lowest available spaces and continue toward the top of the enclosure.

Terminal Block and Module Layout for a Single-Wide Enclosure (CLT-2DIMU8 and CLX-2DIMU8 Shown)

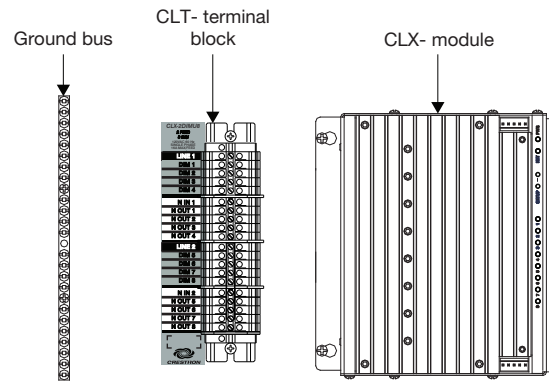

Terminal Block and Module Layout for a Double-Wide Enclosure (CLT-2DIMU8 and CLX-2DIMU8 Shown)

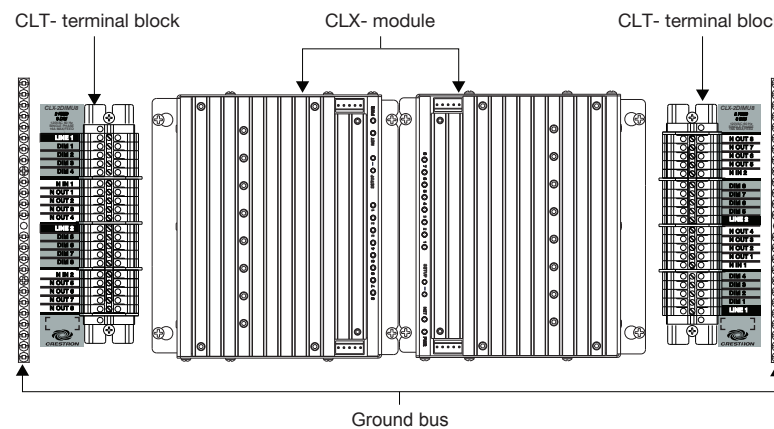

NOTE: Unless otherwise indicated, the lighting system specified in this guide is modular, requiring assembly in the field by a licensed electrician in accordance with all national and local codes.

If an assembled UL Listed panel is required, Crestron offers this service through its UL Listed panel shop. This includes complete in-factory system configuration and assembly by Crestron for an additional fee.

Terminal Block Installation and Field Wiring

Terminal block installation requires installation of the supplied adhesive label and the terminal block. The adhesive label provides the labeling for each terminal in the terminal block and is designed to accommodate installation into the left or right side of a cabinet. Refer to the illustrations that follow for details.

WARNING: The CLX-2DIMU8 may be powered from multiple circuit breakers.

NOTE: Both left-side and right-side adhesive wiring labels are provided. The left-side labels are used in both single- and double-wide enclosures. The right-side labels are used only in double-wide enclosures.

1. Remove the backing from the left- or right-side adhesive wiring label.
2. Apply the adhesive label by aligning the holes in the label with the holes on the Crestron Automation Enclosure where the terminal block is to be mounted. The wiring label lies beneath the terminal block.

3. Use the two supplied self-tapping Phillips pan head screws (8B x 1/4-inch length) to secure the terminal block to the Crestron Automation Enclosure.

CAUTION: Bypass jumpers are provided to allow testing of circuits and to protect the module during installation. When properly secured by five screws, each of the two jumpers on the black and red sections of the terminal block shorts the line in to dim out so that the circuit is energized. Do not remove any bypass jumpers until all feed and load wiring has been completed, the circuit has been tested for electrical faults, and the module has been installed. Refer to "Module Installation and Wiring" for details.

Furthermore, the two jumpers on the white sections of the terminal block tie the neutral ins to the neutral outs. These jumpers should never be removed.

NOTE: Use copper conductors only—rated 75 °C or greater.

4. Turn off the circuit breakers.
5. Connect the circuit feed (line and neutral) and controlled circuit (load) wires to the terminal block per the markings provided on the wiring label. Terminal blocks accept one 14–10 AWG wire. Strip the wires to 1/2 inch (13 millimeters). Tighten terminal blocks to 9 in-lb.
6. Grounding terminal blocks are available in the cabinet for termination of ground wires. Tighten to 35 in-lb (14–10 AWG), 40 in-lb (8 AWG), or 45 in-lb (6–4 AWG).
7. Test each circuit for electrical faults by turning on each of the circuit breakers and checking that the breakers do not trip and that power is delivered to the proper loads.

Wiring the Terminal Block to the Feed and Load(s) (Single-Wide and Left-Side Double-Wide Enclosures)

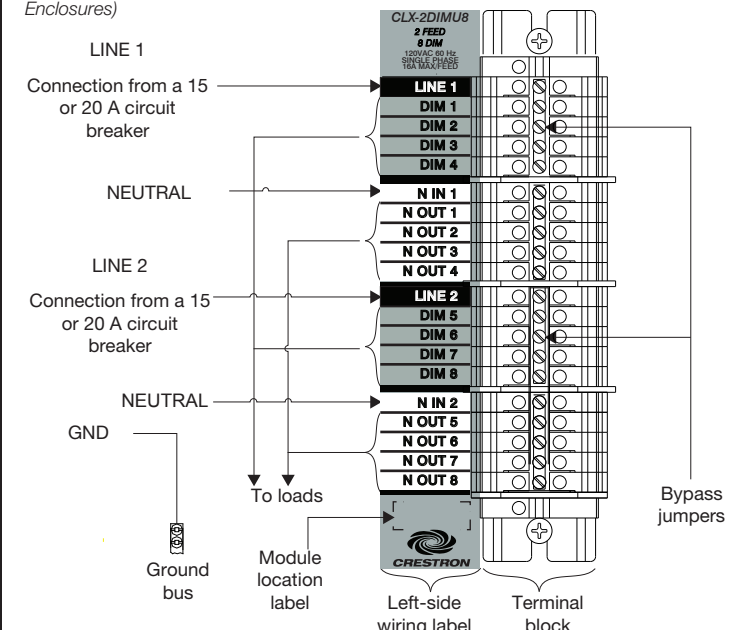

Wiring the Terminal Block to the Feed and Load(s) (Right-Side Double-Wide Enclosures)

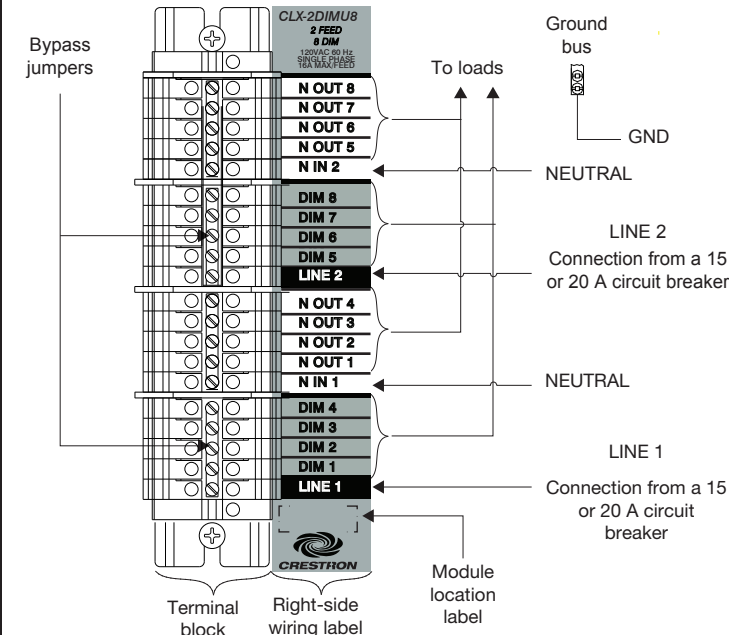

Module Installation and Wiring

CAUTION: The module contains electrostatic sensitive devices (ESDs); the unit must be handled from the metal chassis. Do not touch the PC board or components.

NOTE: Modules are to be installed after enclosure has been completely wired. Refer to "Terminal Block Installation and Field Wiring" for details.

Install and wire the module.

1. Turn off the circuit breakers.
2. Use the four supplied self-tapping Phillips pan head screws (8B x 1/4-inch length) to secure the module to the enclosure.
3. Connect the wires from the module to the terminal block. Each wire exits the module directly in line with, and is the same color as, the terminal to which it should be connected. Wires are prestripped to 1/2 inch (13 millimeters). Tighten to 9 in-lb.
4. If the module is being installed above another module within the enclosure, attach the supplied module interconnect cable between the two modules. The illustration that follows shows the area within a double-wide enclosure where the corners of four modules meet.

NOTE: One wire on the module interconnect cable may be a different color from the rest. The color has no bearing on its orientation during installation.

Using Module Interconnect Cable to Wire One Module to Another

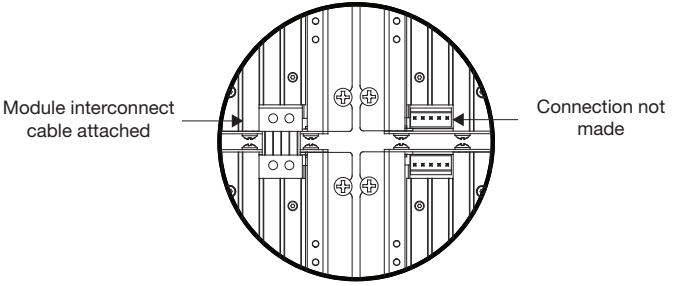

5. Turn on the circuit breakers and verify that the green PWR LED on the module lights, the breakers do not trip, and power is delivered to the loads.
6. Turn off the circuit breakers.

NOTE: Before the bypass jumpers are removed, make sure to properly connect and program the control system that provides functionality to the system.

7. Remove the bypass jumpers on the black and red sections of the terminal block. The jumpers on the white sections of the terminal block must remain installed.

Wiring the Terminal Block to the Module (Single-Wide and Left-Side Double-Wide Enclosures)

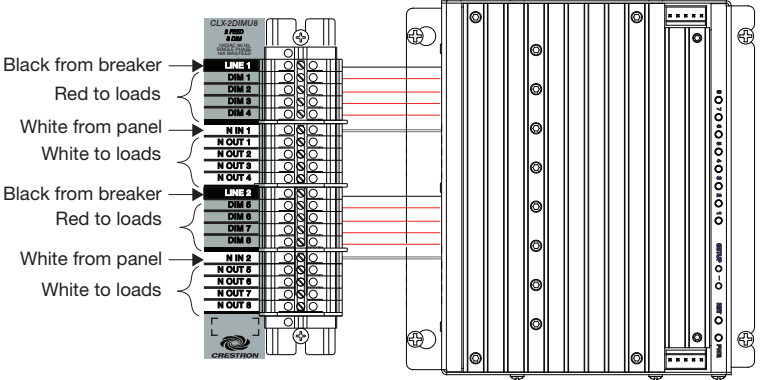

Removing the Line Jumpers after Testing (Single-Wide and Left-Side Double-Wide Enclosures and Right-Side Mounted CLT-2DIMU8 Shown)

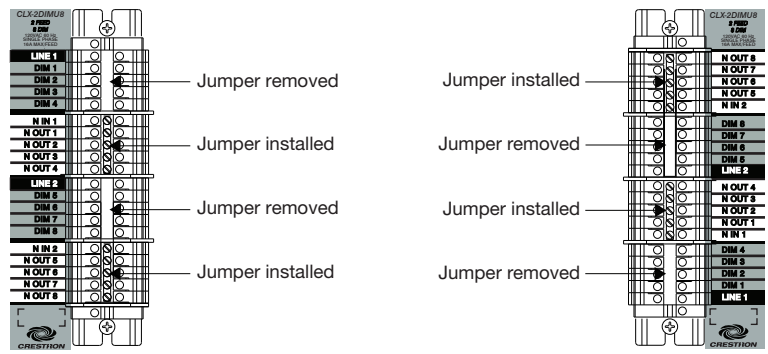

Wiring the Terminal Block to the Module (Right-Side Double-Wide Enclosures)

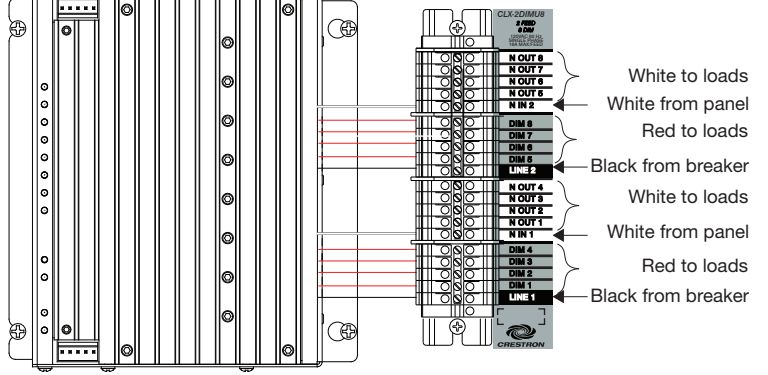

Wiring the Terminal Block to the Module (Single-Wide Enclosures)

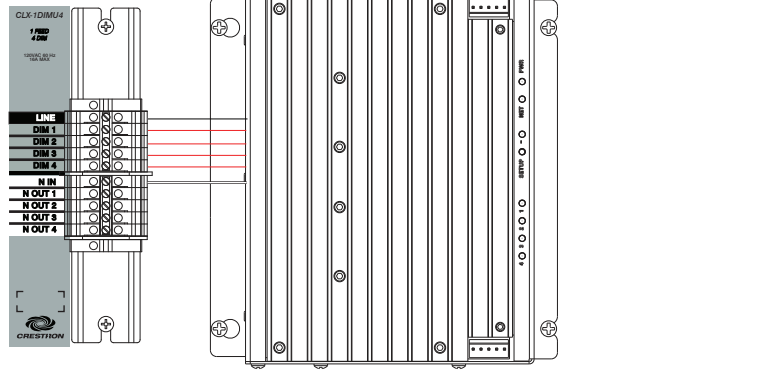

Removing the Line Jumpers after Testing (Left-Side Mounted CLT-1DIMU4 Shown)

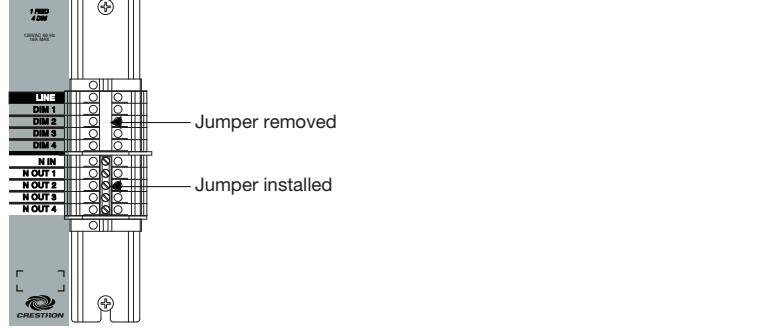

NOTE: This equipment has been tested and found to comply with the limits for a Class A digital device, pursuant to part 15 of the FCC Rules. These limits are designed to provide reasonable protection against harmful interference when the equipment is operated in a commercial environment. This equipment generates, uses, and can radiate radio frequency energy and, if not installed and used in accordance with the instruction manual, may cause harmful interference to radio communications. Operation of this equipment in a residential area is likely to cause harmful interference in which case the user will be required to correct the interference at his own expense.

Industry Canada (IC) Compliance Statement
CAN ICES-3(A)/NMB-3(A)

This product is Listed to applicable UL® Standards and requirements tested by Underwriters Laboratories Inc.
Ce produit est homologué selon les normes et les exigences UL applicables par Underwriters Laboratories Inc.

Federal Communications Commission (FCC) Compliance Statement
This device complies with part 15 of the FCC Rules. Operation is subject to the following two conditions: (1) This device may not cause harmful interference, and (2) this device must accept any interference received, including interference that may cause undesired operation.

CAUTION: Changes or modifications not expressly approved by the manufacturer responsible for compliance could void the user's authority to operate the equipment.

8. Turn on the circuit breakers.

NOTE: Power must be supplied to LINE 1 for the module to communicate with the control system or for any of the circuits to operate.

9. If the program is not running yet, test the loads using Local mode.

Controlling Local Loads and Setting Load Type

Use Local mode to verify that each load is connected to the proper output on the modules. Refer to the illustration that follows for button locations.

1. Tap the **SETUP** button to enter Local mode. Output 1 turns full on.
2. Press the mode button to cycle through the dimming modes, and press the **SETUP** button to save the setting and advance to the next output. The dimming mode is identified by the blinking LED.
 - Green indicates forced reverse phase.
 - Red indicates forced forward phase.
 - Yellow and green indicate auto-select reverse phase.
 - Yellow and red indicate auto-select forward phase.
 - Red and green indicate non-dim.
3. Tap the **SETUP** button to advance to output 2. Repeat step 2 for the remaining outputs.
4. After turning on the last output, press the **SETUP** button again to turn on all outputs and verify that they are operating correctly.
5. Press the **SETUP** button to turn off all outputs and LEDs and exit Local mode.

NOTE: Adjustment to the dimming mode locally is disabled if the dimming phase is set in the SIMPL program.

CLX-1DIMU4 Mode and SETUP Button Locations

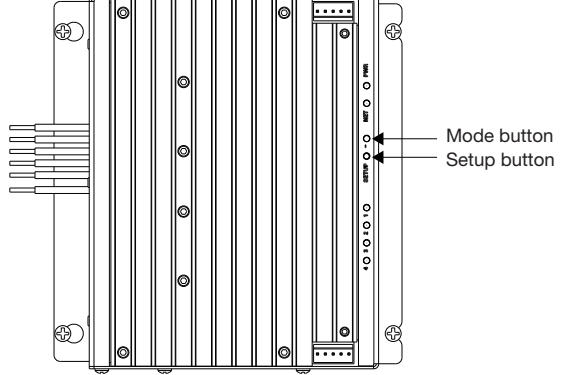

Troubleshooting

The following table provides corrective actions for possible trouble situations. If further assistance is required, please contact a Crestron customer service representative.

| TROUBLE | POSSIBLE CAUSE(S) | CORRECTIVE ACTION |
|--|---|--|
| The output does not appear to dim below 50%. | The dimmer channel may have been damaged. | Contact Crestron customer service. |
| The connected LED load buzzes and flickers when dimmed. | An incompatible LED fixture is installed. | Verify the connected LED load is dimmable and has been tested. Refer to Crestron's Light Fixture Compatibility Listing at www.crestron.com/resources/lighting-fixture-compatibility . |
| | An incorrect dimming phase is selected. | If it is not a magnetic load, set the dimming phase to Auto or Reverse Phase mode to reduce current spikes to load. |
| The connected LED load flickers or turns off when dimmed to a low level. | The minimum dimming level is set too low. | Adjust the minimum dimming level setting in the SIMPL program to match the minimum level required by the LED load. |
| The LED load does not dim to a low brightness level. | An incorrect dimming phase is selected. | Set the dimming phase to Forward Phase mode. |

The module displays error codes using the dimmer output LEDs. The LED blinks a pattern, such as 3-2 or 2-4, to indicate the error on that output. For example, a 3-2 error blinks the LED three times, pauses for 1 second, blinks two times, pauses for two seconds, and then repeats until the error is corrected. A 2-4 error blinks the LED twice, pauses for 1 second, blinks four times, pauses for two seconds, and then repeats until the error is corrected. Refer to the following table for possible corrections.

| ERROR CODE | ERROR NAME | FAULT DESCRIPTION |
|------------|---|---|
| 1-1 | Dimming Processor Stuck in Bootloader | The firmware upgrade has failed or has been aborted, leaving the slave processor in bootloader. Reboot the unit to reinitiate the firmware upgrade. Contact Crestron customer service if error continues to reappear. |
| 1-2 | Dimming Processor Unresponsive | Communications to the corresponding dimming processor have failed. Reboot the unit or contact Crestron customer service. |
| 1-3 | Dimming Processor Firmware Upgrade Failed | The firmware upgrade has failed or has been aborted, leaving the dimming processor in bootloader. Reinitiate the firmware upgrade from Crestron Toolbox™ software. |
| 2-1 | Overcurrent Tripped | A short circuit or overload has been detected and output has been switched off. <ul style="list-style-type: none"> • Check wiring for shorts. • Verify that the total load connected to the channel is less than 4 A. • Verify that the dimming phase has not been set to Forward Phase mode if an incandescent or electronic load is connected. The channel attempts to resume normal operation after receiving another command to turn on. |
| 2-2 | Shorted FET | The dimmer channel has failed. Disconnect the load and contact Crestron Technical Support. |
| 2-3 | Overtemperature Tripped | The dimming channel has overheated and shut down due to excessive load. <ul style="list-style-type: none"> • Verify that the total load connected to the channel is less than 4 A. • Verify that the panel ventilation is not blocked. The channel resumes normal operation after cooling. |
| 2-4 | Overvoltage Detected | High voltage spikes have been detected and output has been shut down. If a magnetic load is connected, verify that the dimming phase has been set to Forward Phase mode. |
| 3-1 | Zero Cross Fault | The dimmer is unable to lock onto the ac line. If the unit is powered by a generator, verify that generator output is 50/60 Hz and stable. |
| 3-2 | No AC Power on LINE 2 | The CLX-2DIMU8 powers itself from LINE 1 input. Verify the breaker providing LINE 2 input power is energized. |

The product warranty can be found at www.crestron.com/warranty. The specific patents that cover Crestron products are listed at patents.crestron.com. Certain Crestron products contain open source software. For specific information, please visit www.crestron.com/opensource. Crestron, the Crestron logo, Cresnet, and Crestron Toolbox are either trademarks or registered trademarks of Crestron Electronics, Inc. in the United States and/or other countries. UL and the UL logo are either trademarks or registered trademarks of Underwriters Laboratories, Inc. in the United States and/or other countries. Other trademarks, registered trademarks, and trade names may be used in this document to refer to either the entities claiming the marks and names or their products. Crestron disclaims any proprietary interest in the marks and names of others. Crestron is not responsible for errors in typography or photography.

This document was written by the Technical Publications department at Crestron.
©2017 Crestron Electronics, Inc.

Crestron Electronics, Inc.
15 Volvo Drive
Rockleigh, NJ 07647
Tel: 888.CRESTRON
Fax: 201.767.7576
www.crestron.com

Installation Guide - DOC. 7628E
(2040605)
03.17
Specifications subject to change without notice.