

15" ICE MACHINES WITH RISE™ OR NOIR™ PANEL KIT

JKRPL151HL/ JKRPR151HL/ JKRPL151HM/ JKRPR151HM – 14<sup>7</sup>/<sub>8</sub>" x 33<sup>13</sup>/<sub>16</sub>" x 24" (depth without handle)

PRODUCT DIMENSIONS

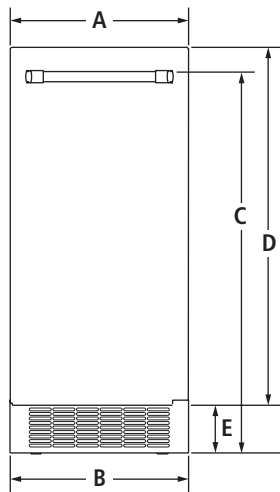

FRONT VIEW

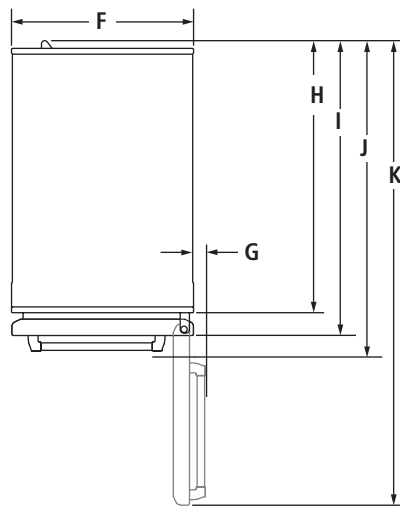

TOP VIEW

MODEL #		JUIFX15H WITH JKRPL151HL, JKRPR151HL, JKRPL151HM OR JKRPR151HM PANEL KIT	
		in	cm
<b>A</b>	Width	14 <sup>7</sup> / <sub>8</sub>	37.9
<b>B</b>	Width of grille	14 <sup>7</sup> / <sub>8</sub>	37.8
<b>C</b>	Height to top of handle RISE™ handle	31 <sup>1</sup> / <sub>2</sub>	80.1
	NOIR™ handle	31 <sup>15</sup> / <sub>16</sub>	80.2
<b>D</b>	Height of door	30 <sup>1</sup> / <sub>8</sub>	76.5
<b>E</b>	Height of grille	3 <sup>15</sup> / <sub>16</sub>	10.1
<b>F</b>	Width of recessed ice machine	14 <sup>15</sup> / <sub>16</sub>	37.9
<b>G</b>	Width from side of ice machine to handle – door open 90° RISE™ handle	2 <sup>15</sup> / <sub>16</sub>	7.4
	NOIR™ handle	2 <sup>1</sup> / <sub>4</sub>	5.7
<b>H</b>	Depth without door	21 <sup>9</sup> / <sub>16</sub>	54.7
<b>I</b>	Depth with door	23 <sup>11</sup> / <sub>16</sub>	60.2
<b>J</b>	Depth with handle RISE™ handle	26 <sup>7</sup> / <sub>16</sub>	67.2
	NOIR™ handle	25 <sup>13</sup> / <sub>16</sub>	65.5
<b>K</b>	Depth with door open 90°	39	99.2

**IMPORTANT:** Dimensional specifications are provided for planning purposes only. Do not make any cutouts based on this information. Refer to the Installation or Use & Care Guide before selecting cabinetry, verifying electrical/gas connections, making cutouts or beginning installation. All JennAir® appliances are appropriately UL, CUL or CSA approved.



15" ICE MACHINES WITH RISE™ OR NOIR™ PANEL KIT

JKRPL151HL/ JKRPR151HL/ JKRPL151HM/ JKRPR151HM – 14<sup>7</sup>/<sub>8</sub>" x 33<sup>13</sup>/<sub>16</sub>" x 24" (depth without handle)

DIMENSIONS AS INSTALLED

MODEL #		JUIFX15H WITH JKRPL151HL, JKRPR151HL, JKRPL151HM OR JKRPR151HM PANEL KIT	
		in	cm
A*	Height to top of door (min.)	34 <sup>1</sup> / <sub>6</sub>	86.6
B*	Height to top of handle (min.)		
	RISE™ handle	31 <sup>1</sup> / <sub>2</sub>	80.1
	NOIR™ handle	31 <sup>9</sup> / <sub>16</sub>	80.2
C*	Height to top of grille (min.)	3 <sup>1</sup> / <sub>16</sub>	9.4
D*	Height of recessed ice machine (min.)	33 <sup>5</sup> / <sub>8</sub>	85.4
E	Depth with door open 90° (min.)	39	99.2
F	Depth with handle (min.)		
	RISE™ handle	26 <sup>7</sup> / <sub>16</sub>	67.2
	NOIR™ handle	25 <sup>13</sup> / <sub>16</sub>	65.5
G	Depth with door (min.)	23 <sup>11</sup> / <sub>16</sub>	60.2
H	Depth without door (min.)	21 <sup>1</sup> / <sub>2</sub>	54.7
I	Depth of grille (min.)	19 <sup>7</sup> / <sub>8</sub>	50.4

\*Add 1" (2.5 cm) to the height dimension when leveling legs are fully extended.

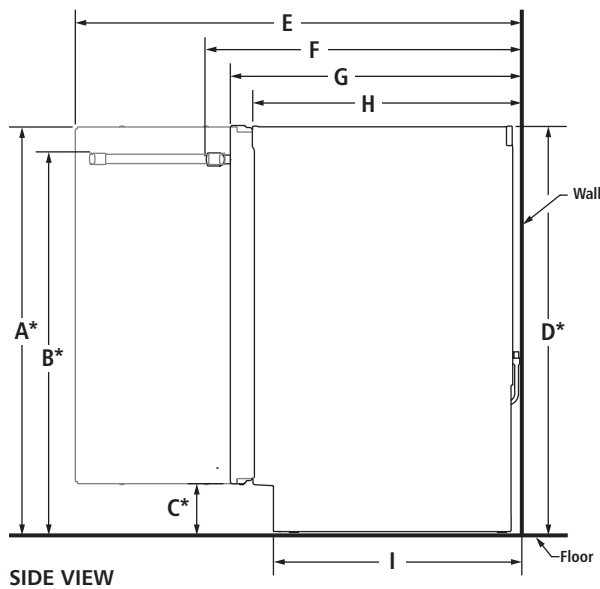

**IMPORTANT:** Dimensional specifications are provided for planning purposes only. Do not make any cutouts based on this information. Refer to the Installation or Use & Care Guide before selecting cabinetry, verifying electrical/gas connections, making cutouts or beginning installation. All JennAir® appliances are appropriately UL, CUL or CSA approved.



15" ICE MACHINES WITH RISE™ OR NOIR™ PANEL KIT

JKRPL151HL/ JKRPR151HL/ JKRPL151HM/ JKRPR151HM – 14<sup>7</sup>/<sub>8</sub>" x 33<sup>13</sup>/<sub>16</sub>" x 24" (depth without handle)

OPENING/CLEARANCE DIMENSIONS

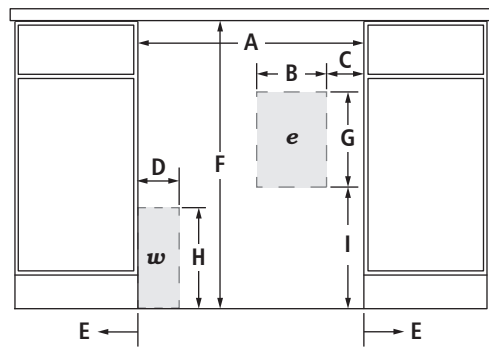

FRONT VIEW

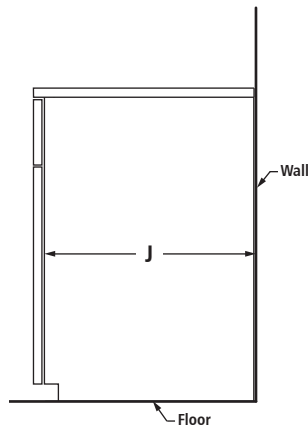

SIDE VIEW

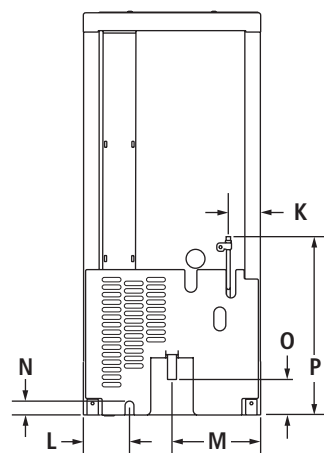

BACK VIEW

MODEL #	JUIFX15H WITH JKRPL-151HL, JKRPR151HL, JKRPL151HM OR JKRPR151HM PANEL KIT	
	in	cm
A	Width (min.)	15 38.1
	Width without hinge side spacer option (min.)	15 38.1
	Width with hinge side spacer option (min.)	15 <sup>3</sup> / <sub>4</sub> * 40.0*
B	Width of outlet location	6 15.0
C	Outlet location – distance from side	1 2.5
D	Width of water connection location	3 <sup>1</sup> / <sub>2</sub> 8.9
E	Minimum width from hinged side of ice machine to fixed wall – door open 90°	2 5.1
	Minimum width from hinged side of ice machine to fixed wall – door fully open 180°	13 <sup>1</sup> / <sub>4</sub> 33.7
	Minimum width from hinged side of ice machine to fixed wall – door fully open 118°	6 <sup>7</sup> / <sub>8</sub> 17.4
F	Height (min.)	34 86.4
G	Height of outlet location	8 20.3
H	Height of water connection location	9 22.9
I	Outlet location – distance from bottom	12 30.5
J	Depth of cabinet (min.)	24 61.0
K	Water line location – distance from side	2 <sup>3</sup> / <sub>8</sub> 6.7
L	Power supply – distance from side	3 <sup>7</sup> / <sub>8</sub> 9.8
M	Drain hose – distance from side	7 <sup>3</sup> / <sub>8</sub> 18.8
N	Power supply – distance from bottom	1 <sup>1</sup> / <sub>4</sub> 3.2
O	Drain hose – distance from bottom	2 <sup>7</sup> / <sub>8</sub> 7.3
P	Water line location – distance from bottom	14 <sup>1</sup> / <sub>2</sub> 36.9
e	Recommended electrical connection location	
w	Recommended water connection location	

\*Install <sup>3</sup>/<sub>4</sub>" (1.9 cm) front hinge-side spacer flush with face of adjacent cabinet and <sup>3</sup>/<sub>4</sub>" (1.9 cm) back hinge-side spacer 6" (15.2 cm) from back wall.

**ELECTRICAL REQUIREMENTS**

115 volt, 60 Hz, AC only, 15- or 20-amp fused, grounded circuit is required. A dedicated circuit is recommended. Use an outlet that cannot be turned off by a switch. Do not use an extension cord.

**WATER PRESSURE REQUIREMENTS**

A cold water supply with water pressure between 30 and 120 psi (207 and 827 kPa) is required to operate the ice maker. Call a licensed, qualified plumber with any questions about the water pressure.

**Reverse Osmosis Water Supply**

**IMPORTANT:** The use of a reverse osmosis system with this product is not recommended. However if you do use reverse osmosis, follow these instructions.

**IMPORTANT:** The pressure of the water coming out of a reverse osmosis system going to the water inlet valve of the ice machine needs to be between 30 and 120 psi (207 and 827 kPa). If a reverse osmosis water filtration system is connected to the cold water supply, the water pressure to the reverse osmosis system needs to be a minimum of 40 to 60 psi (276 to 414 kPa).

**IMPORTANT:** Dimensional specifications are provided for planning purposes only.

**Do not make any cutouts based on this information.** Refer to the Installation or Use & Care Guide before selecting cabinetry, verifying electrical/gas connections, making cutouts or beginning installation. All JennAir® appliances are appropriately UL, CUL or CSA approved.

