

FISHER & PAYKEL

ACTIVESMART™
FREESTANDING REFRIGERATOR

CONTEMPORARY

QUAD DOOR REFRIGERATOR FREEZER ICE & WATER

RF203QDU

QUAD DOOR REFRIGERATOR FREEZER NON-ICE & WATER

RF203QD

USER GUIDE

US CA

CONTENTS

Safety and warnings	4
Before you begin	9
Using the Control panel	10
Storage features	12
Using your appliance	13
WiFi connection	27
Cleaning and care	28
Foodcare	34
Moving or storing your appliance	35
User warnings and sounds	36
Troubleshooting	37
Manufacturer's warranty	42

Registration

To register your product visit our website: fisherpaykel.com/register.

⚠ WARNING!



Electric Shock Hazard

Failure to do so can result in death, electric shock, fire or injury to persons.

- Read and follow the safety and warnings outlined in this User guide before operating this appliance.

⚠ WARNING!



Risk of fire/flammable material

- This refrigerator contains flammable refrigerant isobutane (R600a).

SAFETY AND WARNINGS

READ AND SAVE THIS GUIDE

WARNING!

Read entire manual. Failure to follow all guides and rules could cause personal injury or property damage. When using this appliance, always exercise basic safety precautions including the following:

General Use

- This product has been designed for use in a normal domestic (residential) environment.
- Children should be supervised to ensure that they do not play with the appliance.
- Cleaning and user maintenance shall not be undertaken by children without supervision.
- This appliance can be used by children aged from 8 years and above and persons with reduced physical, sensory or mental capabilities or lack of experience and knowledge if they have been given supervision or instruction concerning use of the appliance in a safe way and understand the hazards involved.
- The manufacturer's installation instructions for product and cabinetry ventilation must be followed when installing the appliance.
- To avoid hazard due to instability of the appliance, it must be fixed in accordance with installation instructions.
- Keep ventilation openings, in the appliance enclosure or the built-in structure, clear of obstruction.
- Do not use mechanical devices or other means to accelerate the defrosting process, other than those recommended by the manufacturer.
- Do not damage the refrigerant circuit.
- In case of damage to the refrigerant circuit, ventilate the area by opening all windows.
- Do not operate electrical equipment or any other equipment that may produce arcs, sparks or flames in the area. Contact your Fisher & Paykel trained and supported service technician immediately to arrange for the appliance to be repaired.
- It is hazardous for anyone other than an Fisher & Paykel trained and supported service technician to service this appliance.
- Connect to potable water supply only.
- This refrigerating appliance is not intended to be used as a built-in appliance.
- This refrigerating appliance is intended to be used at ambient temperatures ranging from 61 °F (16 °C) to 100 °F (38 °C). The product performance may be compromised when operating outside of this temperature range.

Electrical

- This appliance must be installed in accordance with the installation instructions before use.
- To allow disconnection of the appliance from the supply after installation, incorporate a switch in the fixed wiring in accordance with the wiring rules.
- Never unplug your refrigerator by pulling on the power cord. Always grip the plug firmly and pull straight out from the outlet.
- Do not plug in any other appliance at the same power point as your refrigerator or use extension cords or double adapters.
- Repair or replace immediately all electric service cords that have become frayed or otherwise damaged. Do not use a cord that shows cracks or abrasion along its length or at either the plug or appliance end.
- If the power supply cord is damaged, it must only be replaced by your Fisher & Paykel trained and supported service technician because special purpose tools are required.

SAFETY AND WARNINGS

- When moving your appliance away from the wall, be careful not to roll over or damage the power cord.
- **WARNING:** Do not use electrical appliances inside the food storage compartments of the appliance, unless they are of the type recommended by the manufacturer.
- When positioning the appliance, ensure the power cord is not trapped or damaged.
- Do not locate multiple portable socket-outlets or portable power supplies at the rear of the appliance.

Food safety

- Regularly clean accessible draining systems and surfaces that come in contact with food.
- Ensure any raw meat or fish is stored in sealed containers to prevent cross-contamination.
- Immediately clean any drips or spills on surfaces.
- If the appliance will be left empty for long periods, switch off, defrost, clean, dry, and leave the door open to prevent mould developing within the appliance.
- Opening the door for long periods can cause a significant increase of the temperature in the compartments of the appliance.

Storing food and drinks/wine

- Do not store explosive substances such as aerosol cans with a flammable propellant in this appliance.
- Never store volatile or flammable materials in your appliance as they may explode.
- Never freeze liquids in glass containers. Liquid expands during freezing, which may cause the container to explode.
- Never freeze carbonated drinks. They may explode.

Servicing

- Your refrigerator is designed to operate for many years without the need for service checks. However, if your refrigerator is malfunctioning, have it attended to by your Fisher & Paykel trained and supported service technician as soon as possible. All electrical repairs must be carried out by an adequately trained service technician or qualified electrician.
- The LED light cannot be serviced by the user. Contact your Fisher & Paykel Dealer or Fisher & Paykel trained and supported service technician.
- If you suspect that the product is not getting cold — items such as ice cream are melting— remove all perishable food and store in another appliance or cooler to prevent spoilage. Immediately call for a service technician.

Cleaning

- Use mild dish-washing liquid with warm water and a lint-free cloth to clean the product.
- Avoid using anti-bacterial cleaning products on either the interior or exterior of the cabinet as they may cause rusting of metal components and cracking of plastic components.

Disposal

- Extreme care must be taken when disposing of your old appliance to avoid hazards:
- The flammable refrigerant gas must be safely removed by a qualified service technician.

SAFETY AND WARNINGS

- The thermal insulation foam in this appliance may contain flammable insulation blowing gases, any exposed foam may be highly flammable and must be carefully treated during disposal.
- **WARNING:** Risk of child entrapment. Before you throw away your old refrigerator or freezer, the doors and panels should be removed and the racks left in place so that children may not easily climb inside.
- Consult your local energy authority or local codes as to the best way to dispose of your old appliance.

Water connection

- The water connection to your Ice & Water refrigerator must be installed by an authorised plumber or Fisher & Paykel trained and supported service technician and comply with all state and local laws.
 - Installation and use **MUST** comply with all state and local plumbing codes. Check with your local public works department for plumbing codes. You must follow their guidelines as you install the water filtration system.
 - If the water tank has not been used for an extended period of time, or has developed an unpleasant taste or odour, flush the water system. If the problem persists, replace the water filter cartridge and refer to the flushing instructions detailed in section 'Flushing through the water dispenser.
 - To avoid serious illness or death, only connect your water filter to safe drinking water.
 - The water filter cartridge needs to be changed when the replacement indicator icon illuminates. This will happen every 6 months.
 - If the water filtration system has been allowed to freeze, replace filter cartridge. Failure to replace the disposable filter at recommended intervals may lead to reduced filter performance and failure of the filter, causing property damage from water leakage or flooding.
 - In cases of excessively reduced filter life — we recommend that you consult a local plumber or your water supplier for advice on suitable filtration requirements for the water supplied to your home.
 - Filter replacement is the consumer's responsibility and will not be covered by the warranty except in the case of faulty parts or materials within the filter cartridge.
 - If the water has not created ice for some time or ice has an unpleasant taste or odour dispose of ice and refer to 'IceOn/Off' for flushing instructions. If unpleasant taste or odour persists, you may wish to fit a new filter cartridge.
 - Use new tubing supplied with the refrigerator. **DO NOT** reuse old tubing from old water and ice connections.
 - Your water filtration system can withstand up to 120psi (827kPa) of water pressure.
 - Ensure the supplied pressure limiting valve is installed before installing the water filtration system. **DO NOT** install if water pressure exceeds 120psi (827kPa).
- To reduce the risk associated with property damage due to water leakage or flooding:
- **DO NOT** install systems in areas where ambient temperatures may go above 100°F (38°C) or drop below 33°F (0.6°C).
 - **DO NOT** install on hot water supply lines. The maximum operating water temperature of this filter system is 100°F (38°C).
 - **DO NOT** install where water hammer conditions may occur. If water hammer conditions exist, you must install a water hammer arrester.

WARNING!

To reduce the risk associated with choking:

DO NOT allow children under 3 years of age to have access to small parts during the installation of the water filter.

SAFETY AND WARNINGS

Ice making

- Avoid contact with the moving parts of the ice maker ejector mechanism, and do not place your fingers on the automatic ice- making mechanism while the appliance is in operation.
- At first use or after water filter has been replaced, there may be discolouration in the first bin of ice cubes. Discard the discoloured ice cubes. If discolouration continues in succeeding bins, contact your Fisher & Paykel trained and supported service technician.

Power failure

- In the event of a power interruption, the appliance will automatically save the current temperature settings. When power is recovered, the appliance will revert to the current temperature settings only.
- Most power failures are corrected within a short period of time. 1 - 2 hours loss of power will not affect the appliance's temperatures.
- To avoid sudden change of temperature while the power is off, you should avoid opening the door. A refrigerator will keep food safe for up to 4 hours during a power outage. Keep the door closed as much as possible. Discard refrigerated perishable food such as meat, poultry, fish, eggs, and leftovers after 4 hours without power.

IMPORTANT!

This device complies with part 15 of the FCC Rules. Operation is subject to the following conditions:

- This device may not cause harmful interference.
- This device must accept any interference received, including interference that may cause undesired operation.
- Do not change or modify the wireless communication device in any way. Changes or modifications not expressly approved by Fisher & Paykel could void the user's authority to operate the equipment.

WARNING: The incorporated Wi-Fi module in this appliance is to operate only from channel 1 to channel 11 as per FCC rules.

This device contains licence-exempt transmitter /receiver that comply with Innovation, Science and Economic Development Canada's licence-exempt RSS(s). Operation is subject to the following two conditions:

- This device may not cause interference.
- This device must accept any interference, including interference that may cause undesired operation of the device.

BEFORE YOU BEGIN

- Ensure the installer has completed the final checklist in the installation instructions.
- Read this guide, taking special note of the Safety and warnings section.
- Remove all packaging and dispose of it responsibly. Recycle items that you can.

Refrigerator compartment

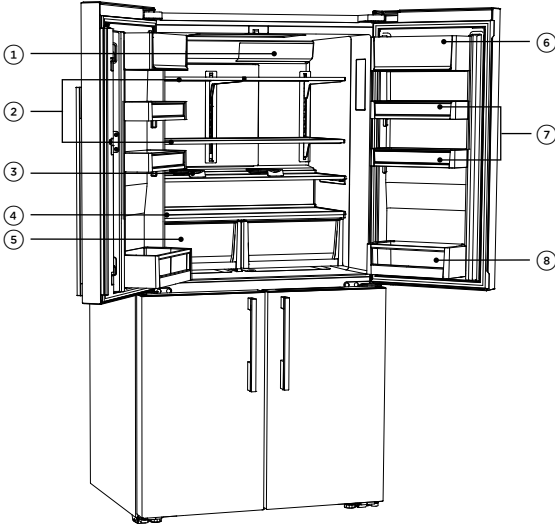

Refrigerator features

- ① Water filter
- ② Shelving
- ③ Bottle racks
- ④ Humidity control compartments
- ⑤ Bin
- ⑥ Dairy compartment
- ⑦ Door shelves
- ⑧ Gallon shelf

Freezer compartment

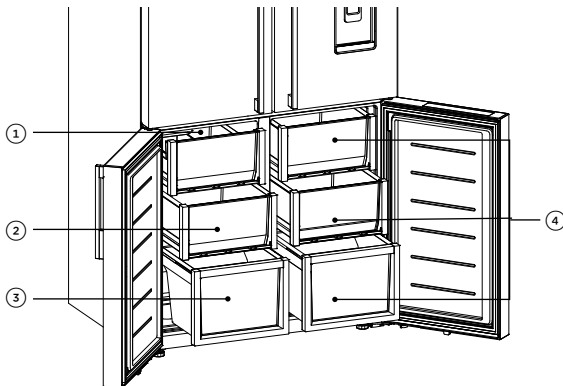

Freezer features

- ① Ice storage bin with scoop
- ② Mid bin
- ③ Large bottom bin
- ④ Variable Temperature Zone

USING THE CONTROL PANEL

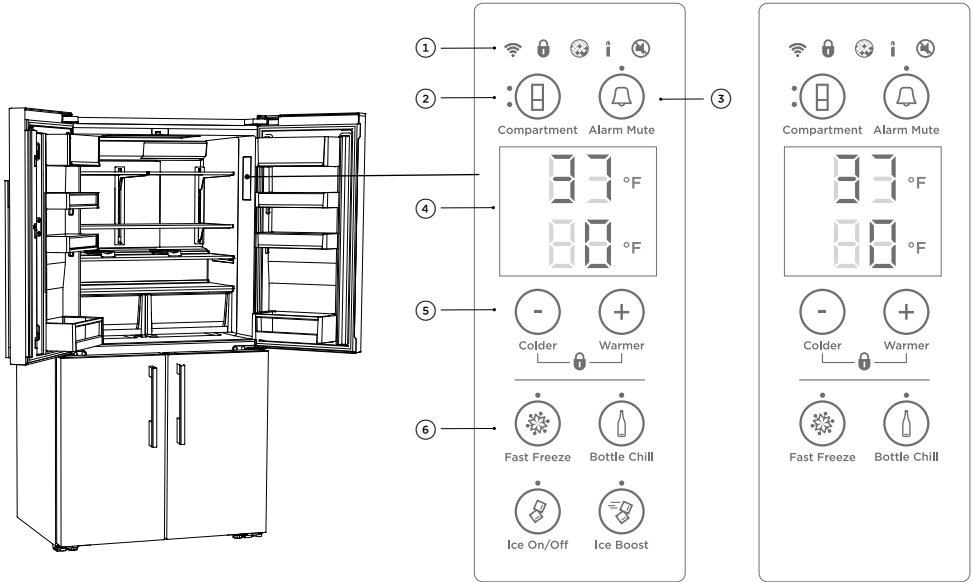

-
- ① WiFi illuminates when functionality is activated.
-
- Illuminates to indicate that the keys on the control panel are locked. Allows you to disable the buttons on the control panel.
-
- Illuminates when the water filter needs replacing.
-
- Illuminates to indicate that Sabbath mode is activated.
-
- Illuminates to indicate key press sounds are deactivated.
-
- ② Allows you to select the compartment to adjust the temperature.
- Upper light to indicate the refrigerator compartment is selected.
 - Lower light to indicate the freezer compartment is selected.
-
- ③ Alarm mute deactivates the door alarm for 20 minutes.
-
- ④ Displays the set temperature of the compartments.
To change between Celsius and Fahrenheit on the display:
Press **+** for 6 seconds.
-
- ⑤ Allows you to adjust the temperature of the selected compartment.
-
- ⑥ Allows you to select features:
- | | |
|-------------|--------------|
| Fast Freeze | Bottle Chill |
| Ice On/Off | Ice Boost |
-

USING THE CONTROL PANEL

Variable temperature zone

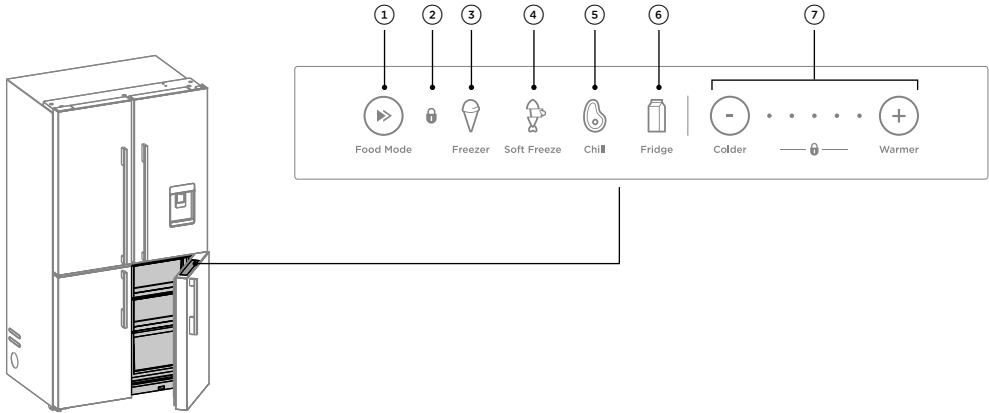

①	FOOD MODE	Enables you to change the setting of the Variable Temperature Zone — FREEZE, SOFT FREEZE, CHILL, FRIDGE.	
②	KEYLOCK	Illuminates to indicate that the keys on the control panel are locked. Allows you to disable the buttons on the control panel.	
③	FREEZER MODE (-18 °C/0 °F)	For general frozen food items that require storage between 1-12 months.	Meat, poultry, seafood, pre-cooked foods and leftovers, some fruits and vegetable, ice cream, and other frozen desserts.
④	SOFT FREEZE MODE (-7 °C/19 °F)	Allows easy portioning of food and the ability to heat, cook or serve foods straight from the compartment without waiting for it to thaw.	Meats, seafood, soups, sauces, pureed foods, bread, desserts and pastries. Not recommended for storage of creamy desserts such as ice cream.
⑤	CHILL MODE (-0.5 °C/31 °F)	An extension of FRIDGE MODE providing the perfect storage zone for highly perishable food to ensure they retain their vital freshness and quality. These items will last slightly longer here compared with storage at FRIDGE MODE.	Highly perishable meats, poultry and seafood. Alcoholic beverages such as beer.
⑥	FRIDGE MODE (3 °C/37 °F)	The ideal mode for fresh foods such as fruit and vegetables, dairy products, meats and drinks.	Fruit and vegetables, dairy products, jams and chutneys/preserves, meats and drinks.
⑦	Temperature adjustment	Allows you to adjust the temperature of the selected compartment.	

STORAGE FEATURES

REFRIGERATOR

Fruit and vegetable bins

Separate fruits and vegetables to prevent ethylene-sensitive produce from ripening too quickly helps to extend their storage life.

Also used for storing deli items and beverages, or for defrosting foods.

Cantilever glass shelving

Heat-treated safety glass

Can be removed and positioned at heights to suit your storage requirements.

The half-width shelves can be positioned side by side; best when storing large items such as platters.

Maximize the storage space when storing items of varying heights by positioning the half-width shelves at different levels.

Dairy shelf and door shelves

The top door shelf is a dairy compartment for storing butter and cheeses.

The middle shelves are designed for general items, condiments and drinks.

The bottom shelves are designed to store large drinks or those drinks you require frequent access to.

Clear windows give ultimate visibility to what is being stored in the door shelves.

Adjustable door shelves with dividers.

Single bottle holders

Placed along the length of any shelf to store a variety of bottles.

Store bottles with the neck facing the front of the refrigerator.

Unused bottle holders can be stacked on top of one another to maximize shelf space.

FREEZER

Ice maker*

Removable ice container.

Hygienic ice scoop.

Freezer bins

Allow for easy storage of frozen food items.

* Ice & Water and Automatic Ice models only.

USING YOUR APPLIANCE

Temperature control

When you turn your refrigerator on for the first time, the cooling system will automatically cool all compartments to their set temperatures within 2-3 hours.

The internal control panel enables you to change and control the temperature of all compartments accurately and independently. The internal control panel default setting is to show the set temperature for the refrigerator compartment.

For common foodstuffs, the factory default setting provides the optimum setting for foodcare.

How to adjust the temperature—Refrigerator compartment

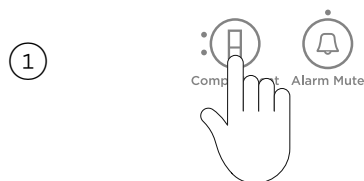

Press **Comp** until the refrigerator compartment light is illuminated, indicated by the top light.

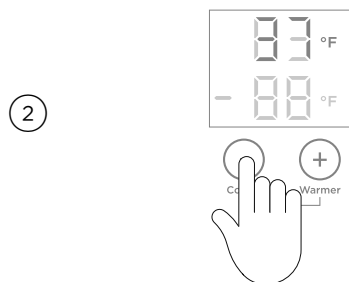

Press **+** to increase the temperature, press **-** to decrease the temperature.

How to adjust the temperature—Freezer compartment

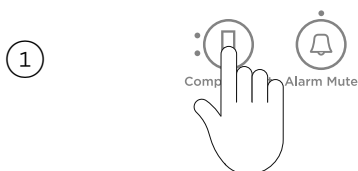

Press **Comp** once to adjust the refrigerator compartment temperature. The refrigerator compartment light will illuminate.

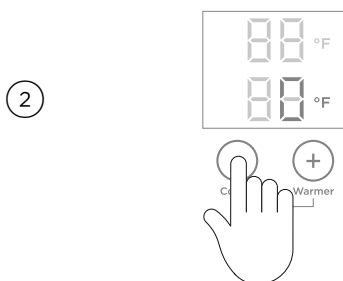

Press **+** to increase the temperature, press **-** to decrease the temperature.



USING YOUR APPLIANCE

Door alarms

If the refrigerator compartment door is left open, the alarm will beep after 90 seconds, if the freezer door is left open the alarm will beep after 60 seconds. If either of the doors remains open, subsequent beeps will sound every 30 seconds for five minutes.

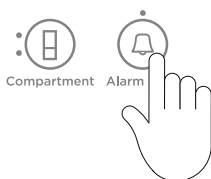
Alarm Mute





To activate/deactivate **ALARM MUTE**, press  once. The light above the  button will illuminate to indicate the refrigerator is muted.

ALARM MUTE will automatically deactivate after 20 minutes or when the door is closed.

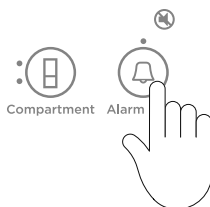
Key Mute



To activate/deactivate **KEY MUTE**, press  for four seconds.

Once **KEY MUTE** is activated the  icon on the internal control panel illuminates, all key sounds are silenced.

Door alarms and the **BOTTLE CHILL** alarm are still operational.

Key lock

KEY LOCK allows you to disable the buttons on the internal control panel. This is useful when cleaning your refrigerator.

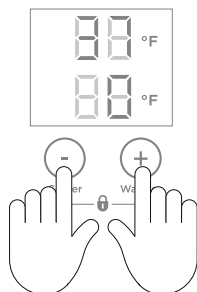

To activate/deactivate **KEY LOCK**, presstand  together for four seconds.

When **KEY LOCK** is activated the  icon on the internal control panel will illuminate. Pressing any of the buttons will sound several beeps to tell you that they are disabled.

USING YOUR APPLIANCE



Sabbath mode

In **SABBATH MODE**, alarms, lights and displays are deactivated for 80 hours.

Once in Sabbath mode:

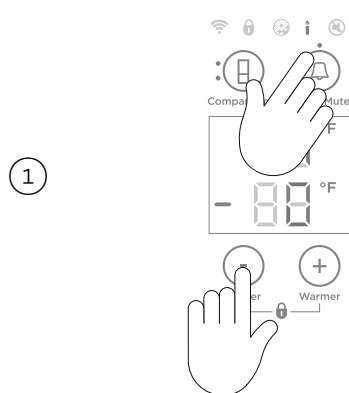
- The interior light will not turn on when you open the refrigerator.
- The door alarms will not operate.
- The display will not illuminate, except the Sabbath mode icon.
- The internal and external control panels will not operate.
- Sabbath mode automatically deactivates after 80 hours.



To activate/deactivate **SABBATH MODE**, press ,  and  together for four seconds.

The  icon on the internal control panel will illuminate when **SABBATH MODE** is activated.

If you turn off your refrigerator while in **SABBATH MODE** it will resume automatically once the refrigerator is switched on again.

USING YOUR APPLIANCE

Changing the Food Mode

1

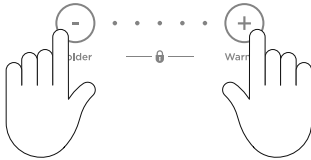

Unlock the Variable Temperature Zone display by pressing **+** and **-** together for four seconds.

2

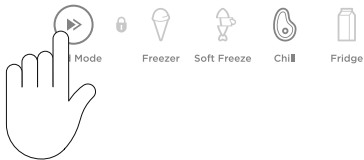

Change the mode by pressing **»**.

FOOD MODE scrolls from left to right (coldest setting to warmest setting).

The **FOOD MODE** selected will illuminate.

3



The default temperature for each **FOOD MODE** will show as one illuminated light in the centre of the scale.

USING YOUR APPLIANCE

Adjusting the temperature

Each **FOOD MODE** will automatically default to the recommended temperature setting for this food mode. Once you have selected the required **FOOD MODE** the temperature can be adjusted as desired.



To increase the temperature of your selected **FOOD MODE** press **+**.

Each light displayed will increase the temperature setting slightly. When all three lights on the right are showing this is the warmest setting.

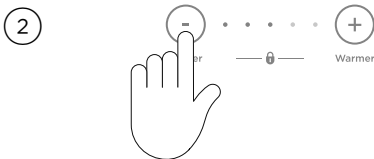

To decrease the temperature of your selected **FOOD MODE** press **-**.

Each light displayed will decrease the temperature setting slightly. When all three lights on the left are showing this is the coldest setting.

If you adjust the temperature for a **FOOD MODE** this adjustment will be remembered for the next time you use this **FOOD MODE**. For example if you select **FREEZER** as the **FOOD MODE** and adjust the temperature to the coldest setting, the next time you use the compartment as freezer it will remember your setting.

Key Lock

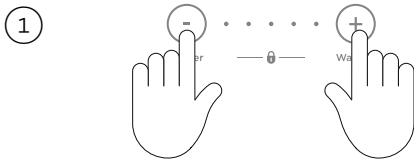

The Variable Temperature Zone display can be locked by pressing **+** and **-** together for three seconds.

When locked, the  icon will illuminate.

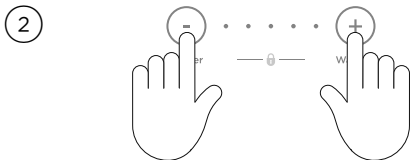

Unlock by pressing **+** and **-** together for four seconds.

The Variable Temperature Zone display will automatically lock after 10 seconds or once the compartment is closed.

USING YOUR APPLIANCE

Features

Fast Freeze

FAST FREEZE boosts freezing speed by dropping to its coldest temperature for 12 hours, helping retain freshness, texture and taste during the freezing process.

1



To activate, press  on the internal display. The **FAST FREEZE** light will illuminate.

2



To deactivate before the 12 hours has elapsed, press  again. When **FAST FREEZE** is deactivated the light is off.

For best results activate the function before it is required. Alternatively, activate it when placing food into the freezer.

USING YOUR APPLIANCE

Bottle Chill

BOTTLE CHILL rapidly chills your beverages in the freezer for a set time of 15 minutes. Depending on bottle size, you may need to return it to the freezer and reset.

1



To activate, press  on the control panel. The **BOTTLE CHILL** light will illuminate.

The  icon will illuminate on the external display (Ice & Water models only).

2

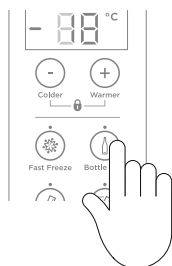

An alarm will sound after 15 minutes to remind you to remove your beverage.



For non water-dispensing models

Open the refrigerator compartment door and press any button on the control panel to silence the alarm.

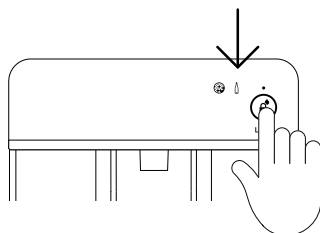
3



For water-dispensing models

The  icon will flash on the external display. Press  on the external display to silence the alarm.

4



To deactivate **BOTTLE CHILL** before 15 minutes, press the  button on the control panel.

When **BOTTLE CHILL** is deactivated, the light will not illuminate and the icon is not visible on the external display (Ice & Water model only).

USING YOUR APPLIANCE

Ice On/Off

ICE ON/OFF activates automatic ice - this is only available in the freezer compartment. Your ice maker is designed to automatically dispense ice into the ice storage bin below until it detects the bin is full. The more ice you use, the more it makes. Before first use the automatic ice systems needs to be flushed.

1



To activate/deactivate, press .

When the ice maker is activated the light will illuminate.



Ice Boost

ICE BOOST increases ice production by up to 30% and will automatically deactivate after 24 hours.

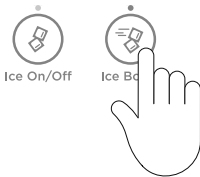
1



When you first turn your ice maker on, **ICE BOOST** is off.

To activate, press . The light above the  button will illuminate.

ICE BOOST will pause once your ice bin is full.

2



To manually deactivate press  again. The light will not illuminate.

Activating **ICE BOOST** will automatically turn on ice making.

Deactivating ice making automatically deactivates **ICE BOOST**.

USING YOUR APPLIANCE

Manual ice system (where present)

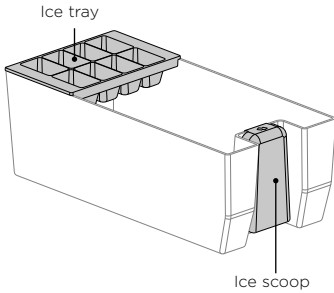

An ice storage bin which sits inside the top freezer bin provides storage for and gives you access to clean, clear ice cubes. Attached to the ice storage bin is the ice scoop which provides hygienic access to ice.

To make ice

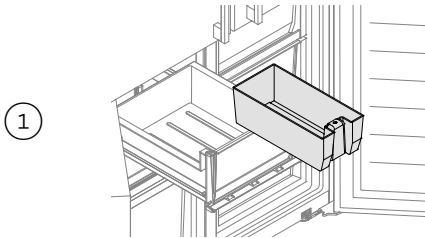

Take the ice tray from the top of the ice storage bin. Fill the tray with water. Carefully position the tray back onto the ice storage bin.

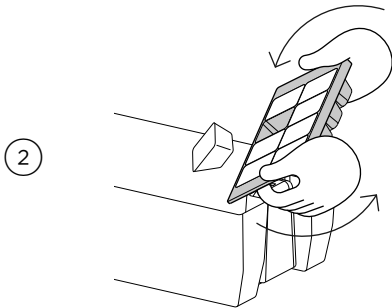

Once the ice is solid, take the ice tray off the ice storage bin and twist the ice tray at each end in opposite directions. Turn the ice tray over the ice storage bin to dislodge the cubes into the bin.

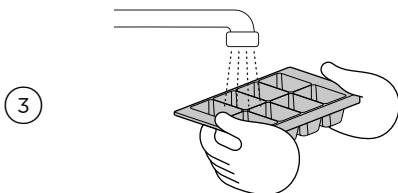

Fill the ice tray with clean water and repeat to fill the ice storage bin.

USING YOUR APPLIANCE

Information about your ice maker

Your automatic ice maker will produce approximately eight cubes of ice every 3-4 hours, depending on the freezer compartment temperature and the number of door openings.

The ice cube tray will fill with water. When cubes are frozen, they will be ejected from the ice tray into the ice storage bin. Ice making will continue until the storage bin is full. Ice making will resume once you start to use the stored ice.

Your Ice & Water product comes with a smaller ice bin inside the larger freezer bin.

Attached to the ice storage bin is the scoop for the ice. This scoop provides hygienic access to the ice. If a large amount of ice is required, remove an ice storage bin and allow ice to fall into the larger bin. For maximum ice storage, level the stored cubes with the ice scoop.

If ice is not used often, old cubes will become cloudy, taste stale, will shrink and may stick together. Empty the ice storage bin periodically and wash in lukewarm water. Dry thoroughly and place back into the correct position.

Turn your ice maker off if:

- There is no water supply for several hours.
- You are removing the ice storage bin for a period of time.
- You are going on holiday/vacation.

USING YOUR APPLIANCE

Water dispenser*

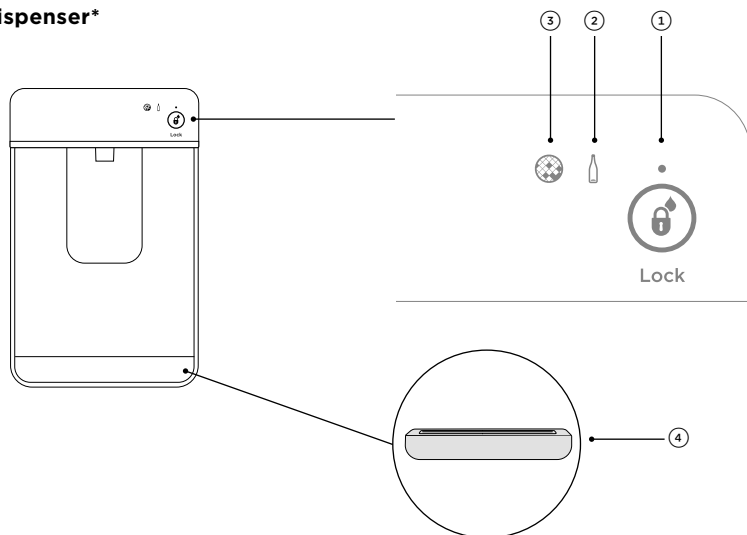

- | | |
|--|---|
| ① Dispenser lock button and LED light | Locks/unlocks the water dispenser. The LED above the lock button will illuminate when dispenser is locked. |
| ② Bottle Chill indicator | Icon will illuminate when BOTTLE CHILL is activated and flashes when the beverage is ready. |
| ③ Filter change indicator | Icon will illuminate when water filter requires changing. |
| ④ Drip tray | The drip tray is designed to fit into the bottom of the water dispenser panel to capture any odd drips of water that may fall after dispensing. |

Using your water dispenser

Ensure you have followed the steps outlined in your installation guide prior to your first use of the water dispenser.

Dispensing

Your water dispenser is designed for one-handed operation.

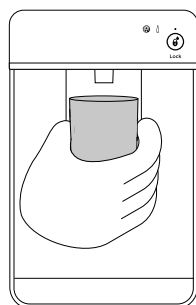

To dispense water, gently press the dispensing pad with a glass or container.

To stop the flow of water, simply pull your glass or container away from the dispensing pad.

Pressing hard against the dispensing pad will not increase the flow or dispense more water.

*Available in Ice & Water models only.

USING YOUR APPLIANCE

Dispenser lock

The **DISPENSER LOCK** is located on the external display and can be activated to prevent water from being dispensed. This is useful when you are cleaning the external display or when there are small children around.

1



To activate/deactivate **DISPENSER LOCK**, press  for four seconds.

When activated the light above the button will illuminate.

When the dispenser pad is pressed, several beeps will sound to alert the user that water cannot be dispensed.

Water filter

The water supplied to your refrigerator is filtered to remove impurities through a filter located internally at the top right corner of the refrigerator. Replace your filter cartridge every 6 months.

- There is a replacement indicator icon  on the internal control panel and external display which will appear when the filter needs replacing. The icon will flash, as a reminder, when water is dispensed.
- Replacement filter cartridges are available from your Fisher & Paykel dealer, online or from a Fisher & Paykel service technician. The details of the replacement filter cartridge are labelled on the cartridge.

Changing the water filter cartridge

Guidance of how to replace your water filter can be found at fisherpaykel.com/water-filter.

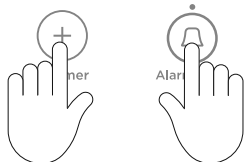

To reset the  filter indicator:

Press  and **+** together for 4 seconds.

The  on the control panel will turn off when reset.

USING YOUR APPLIANCE

Flushing the water filter

Before you start using the Ice & Water function, complete the flushing steps to ensure optimum performance of your water filter.

To flush through the water dispenser

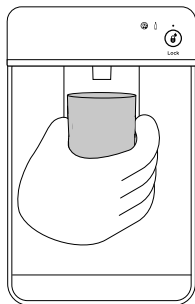

Press the water dispenser pad to dispense 4L of water.

Wait for 4 minutes before dispensing again.



Dispense another 4L of water. Your water dispenser is now ready for use.

Water will continue to drip from the dispenser for a few more days after installation as the remaining trapped air is released from the system.

NOTE: There may be carbon residue dispensed together with water. This is not harmful, and normal during flushing process.

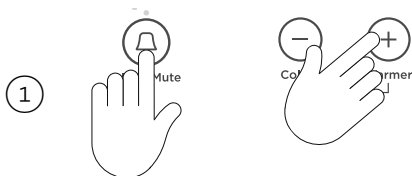
To flush through the automatic icemaker



Press and hold ,  and  together for 4 seconds then close the door(s). The ice tray will flip twice and empty the water into the bin below. The ice tray will flip only after the doors are closed.

Repeat the cycle to help remove any dust in the ice tray collected during manufacture and transport.

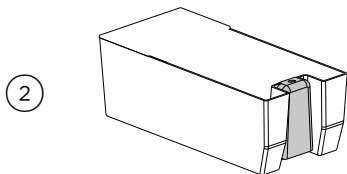

Empty the water in the bin and return the bin correctly. Ensure that the scoop is located in front of the bin.

Once your ice maker is turned on, discard the first 3 harvests of ice (8 cubes per harvest). This will flush away any impurities in the water line and ensure the best ice quality.

Do the above steps after a holiday/vacation or extended periods of not using ice.

USING YOUR APPLIANCE

Glass shelves

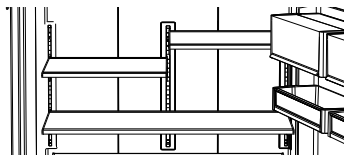

Standard glass shelves can not be repositioned in your refrigerator.

The cantilever glass shelves are designed to be strong and versatile. The half-width and full-width shelves are removable and can be repositioned in your refrigerator.

Some models have glass shelving under the freezer bins. These can be removed if required.

Refer to 'Cleaning and care' for details on how to remove glass shelves.

Bottle holder (where fitted)

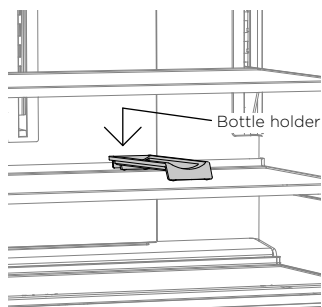

Bottle holders can be used to store a variety of bottles. Unused bottle holders can be stacked up on top of one another so they do not take up unnecessary shelf space.

Bottles are best stored with the neck of the beverage facing the front of the refrigerator.

To position the bottle holder in your refrigerator, slot the back edge of the bottle holder onto the back trim of any shelf in the refrigerator compartment.

Humidity control lids

The control lids are fitted to the fruit and vegetable bins of your refrigerator.

These lids provide a humid microclimate to extend the storage times of fruit and vegetables.

The lids have specially designed grooves that retain moisture to prevent condensation from dripping onto the fruit and vegetables at times of high humidity

WIFI CONNECTION

Your appliance can be connected to your home wireless network and operated remotely using the app.

Getting started

- Ensure your home WiFi network is turned on.
- You will be given step by step guidance on your mobile device.
- It may take up to 10 minutes to connect your appliance.

On your mobile device:

- ① Download the app from www.fisherpaykel.com/connect
- ② Register and create an account.
- ③ Add your appliance and set up the WiFi connection.

CLEANING AND CARE

Exterior

Clean all surfaces with liquid dishwashing detergent dissolved in warm water and a soft cloth. Rinse with clean water and dry with a clean, lint-free cloth.

Do not use any abrasive stainless steel cleaners, glass cleaners, solvents or scourer pads as these will damage the door surface.

For glass door products, clean the gap between the glass and the door or the handles with a toothbrush or small bottle/straw brush.

Door gasket

Clean the magnetic door gasket every three months with a toothbrush, and liquid detergent dissolved in warm water.

Cabinet surround

To maximise operating efficiency regularly vacuum the flooring around your refrigerator. Cleaning behind your refrigerator is required once or twice a year.

1

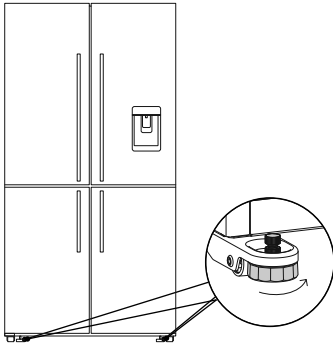

Wind up the feet and carefully ease the refrigerator out of its position. Switch off and unplug.

2

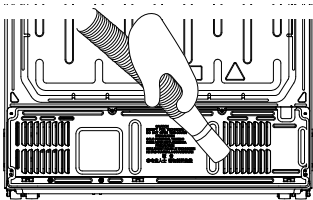

Vacuum the flooring behind your refrigerator and the rear compartment cover (where fitted) to remove dust.

Use a dry lint-free cloth to clean the refrigerator walls and surrounding cabinetry.

After cleaning, plug in and switch on. Push the refrigerator into position and wind feet down.

CLEANING AND CARE

External display and water dispenser (Water-dispensing models only)

①

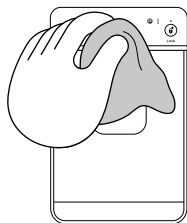

Activate the **DISPENSER LOCK** to prevent water from dispensing when cleaning, refer 'Dispenser lock' section for details.

Clean the pad and external display with a damp, soft lint-free cloth.

Drip tray

①

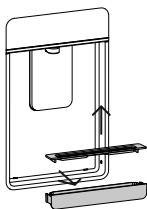

Remove the drip tray from the dispenser panel.

Pull the two halves of the tray apart.

Clean with liquid detergent dissolved in water and a soft lint-free cloth.

Rinse with clean water and dry with a clean, lint-free cloth.

②

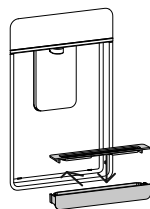

Securely clip the two halves together.

Re-insert the drip tray back into the dispenser panel, rounded sides first.

Interior

Do not use harsh chemicals, abrasives, ammonia, chlorine, bleach, concentrated detergents, solvents or abrasive scouring pads on any part of your refrigerator. Some of these chemicals may dissolve, damage and/or discolour the interior of your refrigerator.

Remove the shelves from the cabinet and door. Wipe all interior surfaces, using only liquid dishwashing detergent dissolved in warm water or baking soda dissolved in warm water (add 1tsp of baking soda to every 500ml of water) and a soft lint-free cloth. Rinse with clean water and dry with a clean, lint-free cloth.

Add a few drops of vanilla essence or vinegar to the water before cleaning to help remove "stale refrigerator" smell.

CLEANING AND CARE

Glass shelves - Refrigerator

To remove

①

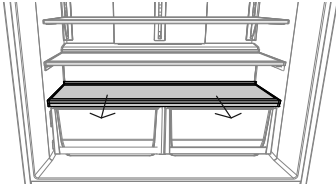

Hold the shelf firmly and pull the shelf towards you.

②

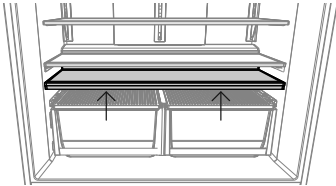

Lift the shelf up vertically.

③

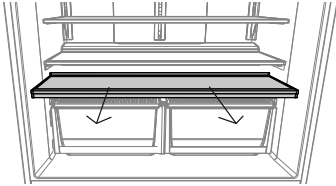

Slide the shelf towards you.

Cantilever glass shelves – half-width and full-width

To remove

①

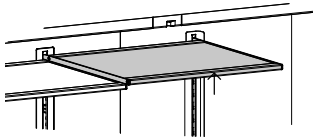

Hold the front and back edge of the shelf firmly.
Push the shelf up vertically to dislodge from back support lugs.

②

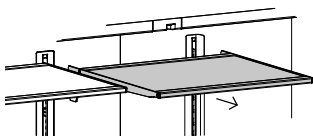

Slide the shelf towards you.

CLEANING AND CARE

Humidity control lid

To remove

①

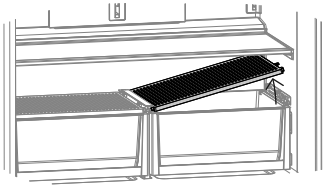

Remove all shelving, follow the steps in section 'Glass shelving'.

Hold the lid firmly and lift the outside edge of the lid up vertically.

②

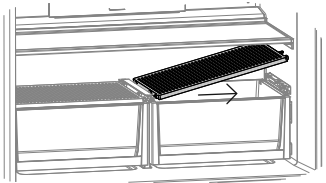

Slide the lid towards the outside wall of the fridge until the lid unclips from the centre bracket.

Pull the shelf towards you.

Support lugs

①

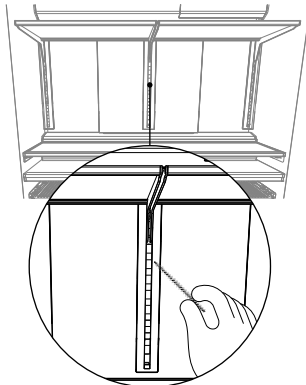

Remove all shelving, follow the steps in section 'Glass shelves- Refrigerator'.

Clean the support lugs with liquid detergent dissolved in water and a tube brush or a clean lint-free cloth.

CLEANING AND CARE

Fixed bins and Freezer bins

To remove

①

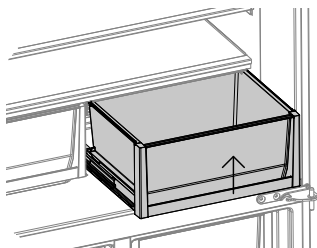

Remove food from the bin.
Hold the centre front of the bin handle.
Lift vertically to unclip from the runners.

②

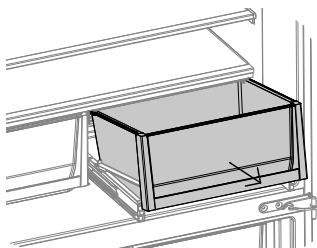

Pull bin towards you to remove from the refrigerator.
Push both runners back into the refrigerator.

How to replace

①

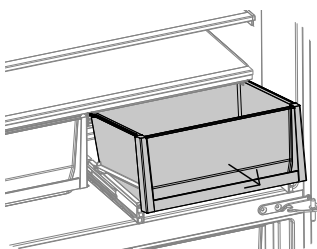

Extend the runners out from the refrigerator.
Place the bin on top of the runners.

②

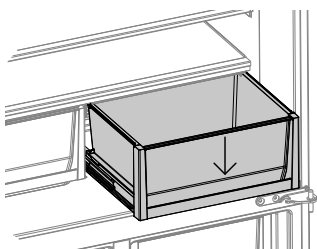

Push the bin down slowly until you feel it clip.

CLEANING AND CARE

Glass shelves - Freezer (if present)

To remove

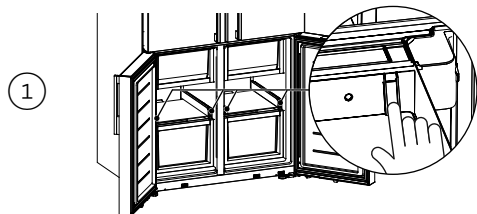

Remove the bin above the glass shelf, refer to 'Fixed bins and Freezer bins'.
Push on the clips on both sides of the shelf.

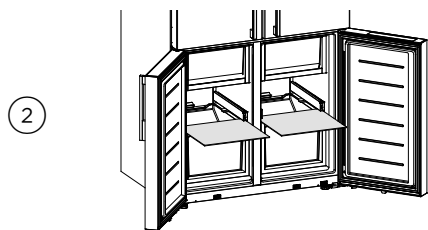

Lift the shelf up to remove from the supports.

Ice storage bin

Clean your ice bin and discard any old ice in the bottom of the bin(s) regularly. Ensure that the ice scoop is placed in correct position in the bin, right hand side or at the front of the bin (model dependent).

For best food care

- Store only high-quality, fresh food in your appliance.
- Store perishable foods in the appliance immediately after purchase. Storing at room temperature increases the rate of deterioration and can allow harmful microbial growth.
- Foods such as meat, poultry and seafood should be well wrapped or sealed in suitable packaging to prevent dehydration, color deterioration, loss of flavor, and transfer of odor.
 - We recommend storing these foods on the bottom shelf of your appliance or in one of the bins to prevent potential spills and cross-contamination with other foods.
- Ensure hot foods and beverages are cooled sufficiently before placing them into the appliance. Hot items may cause other foods to warm to unsafe temperatures. Hot items may also cause sealed items to sweat/condensate— which is undesirable.
- Beverages are best stored standing upright in the door shelves or on the bottle racks provided.
- Ensure raw and cooked foods are stored separately to avoid cross-contamination.
- Consume food items within the recommended storage times. Discard foods that show sign of spoilage.
- Keep door openings to a minimum to maintain optimum storage temperatures inside your appliance.
- We recommend using **FAST FREEZE** when you are adding food items to your appliance, such as after grocery shopping. This feature will ensure the food is chilled/frozen within the shortest period of time, locking in the freshness and extending the shelf life of your food.

Items stored in your refrigerator

- Dairy items such as butter and cheeses should be stored in the covered door shelf to minimize any transfer of odor or odor absorption from other foods.
- Eggs should be stored in their carton to avoid absorption of strong odors through their porous shell structure.

Items stored in your freezer

- We recommend cooling carbonated beverages only when the **BOTTLE CHILL** function is active.
 - Do not store carbonated drinks without this function in the freezer. Failure to remove beverages could lead to freezing liquid and the likelihood of bottle/can explosion.
- Ensure air is removed from packaging to avoid large formation of ice crystals and prevent freezer burn.
- To maintain freshness and quality, we recommend defrosting foods in the refrigerator. These foods should not be in contact with fresh foods. Ensure partially or fully defrosted foods are never re-frozen – cook immediately.

MOVING OR STORING YOUR APPLIANCE

If your refrigerator is turned off for any reason, wait 10 minutes before turning it back on. This will allow the refrigeration system pressures to equalise before restarting.

Moving your refrigerator

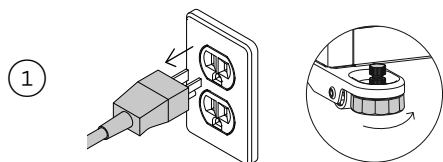

Turn off the refrigerator and unplug from the power point. Remove all food.

Turn the adjustable feet to the right as far as they will turn.

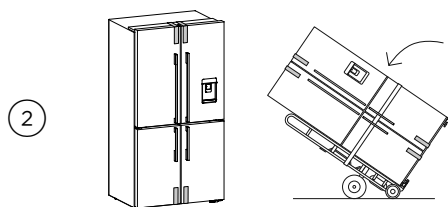

Ease the refrigerator out of its position.

Tuck the power cord away, tape the shelves in place and tape the doors closed. If the cabinet needs to be placed at an angle or laid down, carefully lay it on its side (the left hand side when viewed from the front).

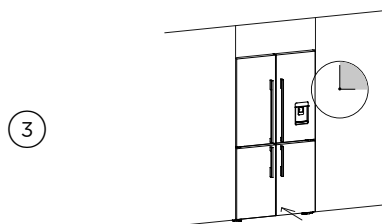

Relocate and install. If the appliance has been left on its side for any length of time, leave it standing upright as long as you can (a few hours) before turning on.

Take care when moving this refrigerator, ensure all obstacles are removed to prevent any physical impact that may cause damage.

Storing your refrigerator

- When storing your cleaned appliance, leave the doors open. This allows air to circulate and prevents the build up of bacteria and moulds.
- Before using again, clean well using a mixture of warm water and a small amount of liquid dishwashing detergent. Rinse with clean water and dry with a soft lint-free cloth.

Holiday/Vacation time

Leave your refrigerator operating while you are on holiday/vacation.

USER WARNINGS AND SOUNDS

Faults

- Count the number of beeps made when the refrigerator compartment door is opened.
- Record the number and sequence of temperature lights displayed on the internal control panel and contact a Fisher & Paykel trained and supported service technician in order to repair the fault. You can do this by going online to fisherpaykel.com or by contacting our Customer Care Centre.
- To silence the fault alarm press any button on the **internal** control panel.

Normal refrigerator sounds

ActiveSmart™ refrigerators are designed to have excellent energy ratings and cooling performance. As a result, you may hear sounds somewhat different to your old refrigerator.



Normal operational sounds include:

- **Fan air flow sound.** ActiveSmart™ refrigerators have fans which change speed depending on demand. During cooling periods, such as after frequent door openings, fans circulate the cold air in the refrigerator and freezer compartments producing some air flow sound. This is quite normal.
- **Cracking or popping sounds.** This may occur when the automatic defrost function is operating.
- **Running water sound.** This is the liquid refrigerant in the system and can be heard as a boiling or gurgling noise.
- **An audible hissing sound after closing the freezer door.** This is due to the pressure difference between the warm air that has entered the cabinet and suddenly cooled, and the outside air **pressure**.
- **Humming sounds.** This is the compressor running and is quite normal.
- **Gasket noises.** Normally occur over time due to a build up of dirt and/or grime. See 'Cleaning and care' section.
- **Ice maker and water dispenser sounds:**
 - Motor operation (low humming).
 - Running water as the ice maker and/or water tank fills.
 - Water valve opening and closing (hissing sound).
 - Loosened from the ice molding tray (cracking).
 - Ice dropping into bin (clunking).
- **Other sounds may be heard for the following reasons:**
 - Cabinet not level
 - Floor uneven or weak
 - Bottles or jars rattling on shelves

TROUBLESHOOTING

If there is a problem with your appliance, please check the following points before contacting your local Fisher & Paykel trained and supported service technician or the Customer Care Centre.

Product parts and accessories can be purchased through Fisher & Paykel Customer Care Centre or online at fisherpaykel.com (this service is available to selected markets only).

PROBLEM	POSSIBLE CAUSES	WHAT TO DO
Appliance does not operate	No electricity at power outlet.	Check that the plug is correctly connected and power switched on.
		Check another appliance at the same outlet.
		Check house fuse.
Light not working	Light not functioning.	The LED light cannot be serviced by the user. Contact your Fisher & Paykel Dealer or Fisher & Paykel trained and supported service technician.
	Refrigerator not working.	Check refrigerator is turned on at wall.
Light and display not working	Product in SABBATH MODE .	Press and hold  ,  and  together for 4 seconds.
Motor operates for long periods	Hot weather.	Minimise door openings to allow temperature to stabilise.
	Frequent door openings.	
	Large amount of food recently added.	
	Temperature control set too low.	Refer to section 'Temperature control'.
	Doors not sealing properly.	Check that cabinet is level and gasket seals are clean.
Storage compartments too warm	Temperature setting not correct.	Refer to section 'Temperature control'.
	Frequent door openings.	Minimise door openings to allow temperature to stabilise.
	Large amount of food recently added.	
Food freezing in the refrigerator	Temperature setting not correct.	Refer to section 'Temperature control'.
	Food placed directly in front of air outlets.	Move chill sensitive foods away from the centre back of the shelves.
Unfamiliar noises	Cabinet not stable or level.	Refer to your Installation guide or 'User warnings and sounds'.
	Freezer is defrosting.	

TROUBLESHOOTING

PROBLEM	POSSIBLE CAUSES	WHAT TO DO
Unfamiliar noises	Cabinet not stable or level. Freezer is defrosting.	Refer to your Installation guide or 'User warnings and sounds'.
Water in the vegetable bins	Condensation is formed by the water produced by fruit and vegetables.	A small amount of condensation is beneficial for fruit and vegetable storage. Wipe out water with a cloth.
Exterior of cabinet is warm	This is normal.	
Condensation on outside of refrigerator/freezer	Not unusual during periods of high humidity.	Wipe dry.
Condensation inside refrigerator compartment	Frequent or long door openings.	Minimise door openings.
	Door gasket leaking.	Check that gasket is sitting flat and sealing tightly.
	Not unusual during periods of high humidity.	Wipe dry.
Door out of alignment	With time and usage, movement may occur.	Refer to your installation guide.
Tray/bin does not slide in and out evenly	Packaging trapped.	Check to ensure no food or packaging is trapped behind the tray/bin.
	Runners not extending fully.	Holding onto sides of tray/bin, extend the runners fully by using a firm pull – this will reset the runner.
Refrigerator operating inefficiently	Accumulation of dust on or behind the rear compartment cover.	Refer to section 'Cleaning and care'. If problem persists please contact Customer Care.
Cannot adjust temperature in freezer compartment	Either BOTTLE CHILL , FAST FREEZE or ICE BOOST is activated.	Deactivate BOTTLE CHILL , FAST FREEZE or ICE BOOST if function is not desired.

TROUBLESHOOTING

PROBLEM	POSSIBLE CAUSES	WHAT TO DO
Water in the vegetable bins	Condensation is formed by the water produced by fruit and vegetables.	A small amount of condensation is beneficial for fruit and vegetable storage. Wipe out water with a cloth.
Exterior of cabinet is warm	This is normal.	
Condensation on outside of refrigerator/freezer	Not unusual during periods of high humidity.	Wipe dry.
Condensation inside refrigerator compartment	Frequent or long door openings.	Minimise door openings.
	Door gasket leaking.	Check that gasket is sitting flat and sealing tightly.
	Not unusual during periods of high humidity.	Wipe dry.
Door handles out of alignment	With time and usage, movement may occur.	Refer to your installation guide.
Tray/bin does not slide in and out evenly	Packaging trapped.	Check to ensure no food or packaging is trapped behind the tray/bin.
	Runners not extending fully.	Holding onto sides of tray/bin, extend the runners fully by using a firm pull – this will reset the runner.
Appliance operating inefficiently	Accumulation of dust on or behind the rear compartment cover.	Refer to section 'Cleaning and care'. If problem persists please contact Customer Care.
Cannot adjust temperature in freezer compartment	Either Bottle Chill, Fast Freeze or Ice Boost is activated.	Deactivate Bottle Chill, Fast Freeze or Ice Boost if function is not desired.

TROUBLESHOOTING

PROBLEM	POSSIBLE CAUSES	WHAT TO DO
Automatic ice maker does not work	Ice maker has not been turned on.	Switch on ice maker.
	Bin is in the wrong way or there is no bin in place.	Place bin so scoop is on the left side. Ice bin sits directly under ice maker on top left side of freezer.
	Water supply turned off or not connected.	Connect water supply.
	Freezer compartment not working.	Contact Customer Care.
	Water pressure too low.	Check water pressure.
	Water line kinked/squashed.	Check water line for kinks/squashing.
	Filter clogged.	Water filter may need replacing.
Ice cubes have odour/taste	Unsealed packages may be transmitting odour/taste.	Old cubes need to be discarded. Ensure food packaging is sealed.
	Interior of freezer needs cleaning.	Ice storage bin needs to be emptied and washed. Clean refrigerator.
	Poor taste from incoming water.	Filter may need to be replaced with new one. Force 2 - 3 ice tray flips.
Slow ice cube freezing	Door may have been left ajar.	Close door.
	Freezer compartment too warm.	Turn temperature to a colder setting.
Wet ice/ ice clumping	Low water pressure.	Check water pressure.
	Filter blocked.	Replace filter.
	Long freezer door openings.	Gently tap ice with scoop to unstick or, if large clumps occur, empty ice bin and make new ice.
	High ambient temperature.	
	Ice bin left out of freezer compartment for a length of time.	
Ice will stick together over time.		
Filter warning light  is flashing	Filter needs replacing.	Replace filter as soon as possible.
Ice buildup inside freezer compartment	Freezer door not closing tightly.	Arrange items in freezer so door can close tightly.
		Check and clean door gasket seal.

TROUBLESHOOTING

PROBLEM	POSSIBLE CAUSES	WHAT TO DO
Ice maker makes unfamiliar sounds or seems too loud	Normal ice maker operation.	Refer to section 'User warnings and sounds'.
Ice boost function not increasing rate of ice production	Ambient temperature very warm. Refrigerator is in high usage.	Minimise door openings.
Water has poor taste/odour.	Refrigerator not used for an extended period. New filter installed	Dispense 1 gal (4L) of water so fresh water supply is replenished.
Water dispenser does not work	Water supply turned off or not connected. Supply line may be blocked. On first installation there may be air in water system. Filter may be blocked and need replacing. 'DISPENSER LOCK' activated. Water frozen in tank.	Turn water on. Press dispenser for 4 minutes to remove trapped air from water line and to fill the water system. Check supply for kinks or leaks. To remove air, run 3/4 gal (3L) of water through the dispenser. Replace filter (see your 'Service & Warranty' document provided with your refrigerator). Press and hold  for 4 seconds. Increase temperature to a warmer setting in refrigerator compartment and freezer.
Water in first glass is warm	Water dispenser not used for extended period. Tank capacity used recently.	Discard first glass of water dispensed. Allow water time to cool.
Drips overflow drip-shelf	Air trapped in tank. New filter installed.	Flush 3/4 gal (3L) water through dispenser, stopping intermittently. Dispense 1 gal (4L) of water through the dispenser, and then another 1 gal (4L) after 4 minutes.
Water flow rate has slowed down	Filter cartridge is restricted.	Replace filter as soon as possible.

MANUFACTURER'S WARRANTY

For details of your Manufacturer's Warranty and contacts for servicing, please refer to your separate 'Service & Warranty' book provided with your refrigerator.

This product has been designed for use in a normal domestic (residential environment). This product is not designed for any commercial use. Any commercial use by the customer will affect this product's Manufacturer's Warranty.

Complete and keep for safe reference:

Model _____

Serial No. _____

Purchase Date _____

Purchaser _____

Dealer _____

Suburb _____

Town _____

Country _____

FISHERPAYKEL.COM

© Fisher & Paykel Appliances 2021. All rights reserved.

The models shown in this guide may not be available in all markets and are subject to change at any time.

The product specifications in this guide apply to the specific products and models described at the date of issue. Under our policy of continuous product improvement, these specifications may change at any time.

For current details about model and specification availability in your country, please go to our website or contact your local Fisher & Paykel dealer.

864779A 06.21