





ASSEMBLY INSTRUCTIONS

ITEM NO B4740-2 NIGHTSTAND

BOX OF NIGHTSTAND

ITEM	DRAWING	DESCRIPTION	QTY
A		NIGHTSTAND	1
B		WOOD LEG L PACKED INSIDE NIGHTSTAND BOTTOM DRAWER	1
C		WOOD LEG R PACKED INSIDE NIGHTSTAND BOTTOM DRAWER	1

BOX OF NIGHTSTAND HARDWARE LIST

ITEM	DRAWING	DESCRIPTION	QTY
1		SCREW-ICBC M6X35	8
2		ALLEN KEY M4	1

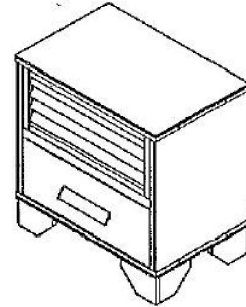

**COMPLETED NIGHTSTAND
ASSEMBLY**

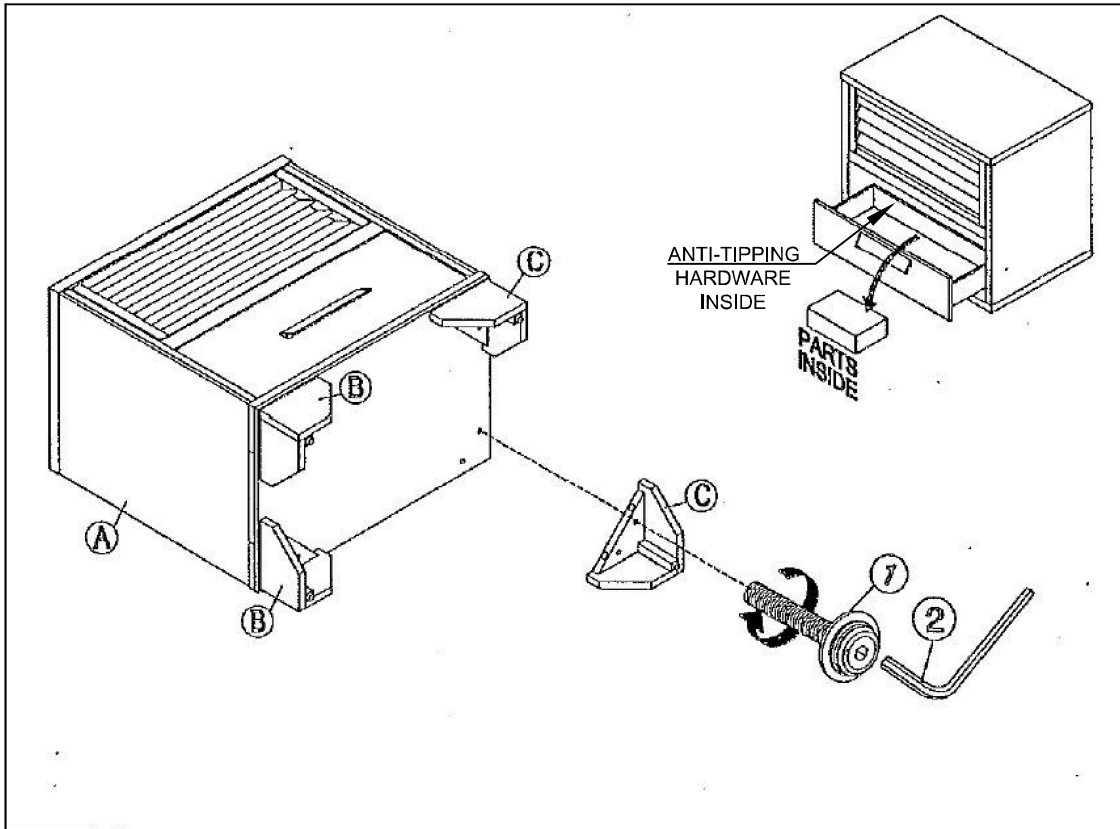

THE HARDWARE IS LOCATED IN THE PACKING ITEMS
THE ANTI-TIPPING HARDWARE IS LOCATED IN THE 2ND DRAWER OF NIGHTSTAND

NOTED: MUST TIGHTEN SCREWS PERIODICALLY. WITH USE SCREW MAY BECOME LOOSE
CHECK TIGHTNESS OF ALL SCREW EVERY 6-8 WEEK..

MADE IN MALAYSIA

PAGE 1 OF 1