

CL4250UFDID/O



FEATURES

- Legacy product image shown; actual product varies slightly.

- Split Climate™ intelligent cooling system revolutionizes Sub-Zero's already-superior preservation capabilities, keeping food even fresher for longer

- ClearSight™ LED lighting system fully illuminates the interior and reduces shadows

- Sleek stainless accents trim the interior, matching the sophistication of the exterior

- Touch control panel is conveniently located for easy access at the tap of a finger

- Night Mode optimizes the interior lighting based on the detected ambient light, reducing the brightness by 90% in dim environments

- Delivers fresh, filtered water through an internal dispenser located discreetly within the refrigerator

- Activate Max Ice Mode to temporarily increase ice production

- Filtered ice ready on-demand and activate Max Ice Mode to temporarily increase ice production

- Lift the base of the flip-up dairy compartments to store taller items on the shelf below

- The base of the expandable freezer basket conveniently slides out of the way, offering customizable storage for taller items below

- Wi-Fi enabled features provide remote access from your mobile device

- Sub-Zero offers an industry-leading full two-year warranty on appliances, along with a full five-year sealed system warranty and a limited twelve-year sealed system warranty

ACCESSORIES

- 42" Stainless Steel Kickplate

- 90° Door Stop

- Air Purification Cartridge

- Custom Front Panel Mounting Kit

- Custom Side Panel Mounting Kit

- Egg Container

- Grille Frame - 84"

- Stainless Steel Flush Inset Grille Panel

- Stainless Steel Side Panel

- Water Filter

- Stainless Steel Flush Inset Door and Drawer Panels with Pro Handle

- Stainless Steel Flush Inset Door and Drawer Panels with Tubular Handle

- Classic Stainless Steel Pro Louvered Grilles

- Stainless Steel Pro Handles

- Stainless Steel Tubular Handles

- Stainless Steel Kickplate

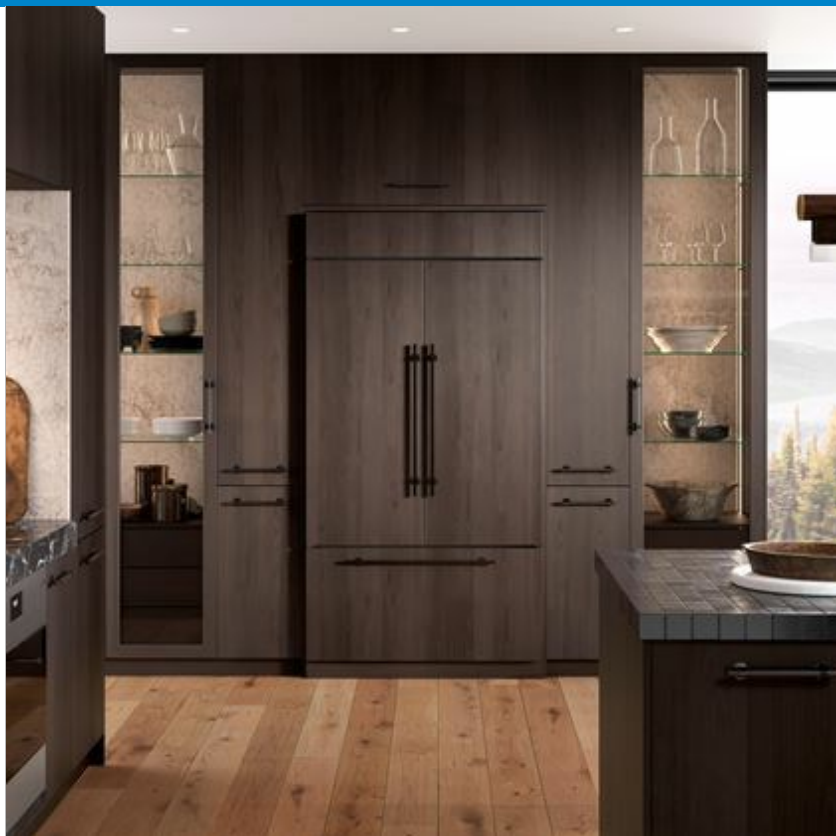

HANDLE ACCESSORIES

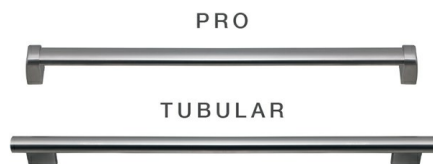

PRODUCT DETAILS

REFRIGERATOR

- 7 glass refrigerator shelves (6 adjustable; 1 stationary)
- 4 crisper drawers with removable dividers
- 6 refrigerator door bins (4 adjustable; 2 stationary)
- 2 flip-up dairy compartments
- Air purification system
- Internal water dispenser
- LED refrigerator and freezer lights

FREEZER

- Full-extension drawer with expandable freezer basket
- Water filtration system
- Automatic ice maker with removable ice container

Accessories are available through an authorized dealer.
For local dealer information, visit subzero-wolf.com/locator.

Specifications are subject to change without notice. This information was generated on July 11, 2022. Verify specifications prior to finalizing your cabinetry/enclosures.

PRODUCT SPECIFICATIONS

Model	CL4250UFDID/O
Dimensions	42"W x 84"H x 24"D
Refrigerator Capacity	18.4 cu. ft.
Freezer Capacity	6.3 cu. ft.
Weight	650 lbs
Electrical Supply	115 VAC, 60 Hz
Electrical Service	15 amp dedicated circuit
Plumbing Supply	1/4" OD copper, braided stainless steel or PEX tubing
Plumbing Pressure	35–120 psi
Receptacle	3-prong grounding-type

DIMENSIONS

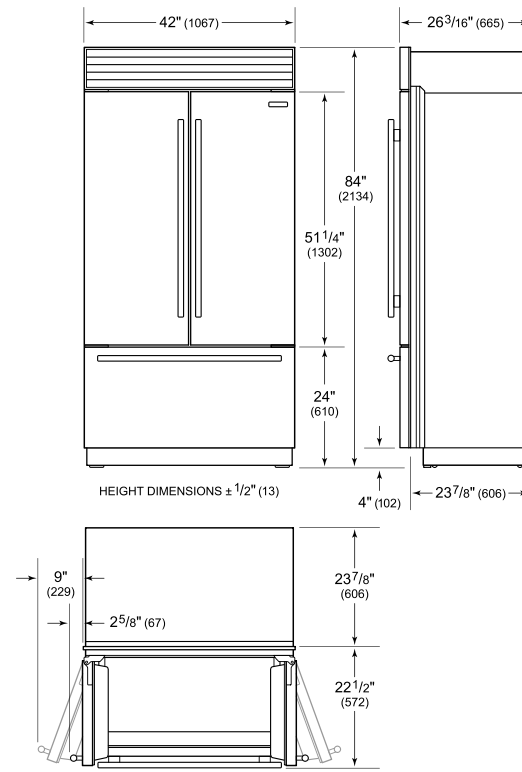

ELECTRICAL

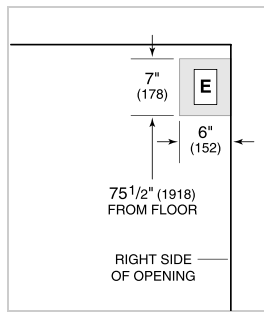

PLUMBING

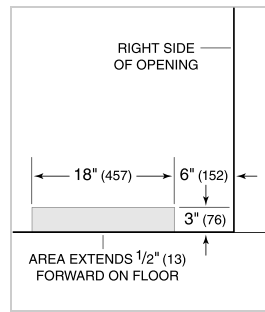

PANEL SPECIFICATIONS For complete panels specifications including width/height, weight requirements, thickness requirements and offset details visit subzero-wolf.com/builtinconfigurator.

NOTE: Dimensions in parenthesis are in millimeters unless otherwise specified

INTERIOR VIEW

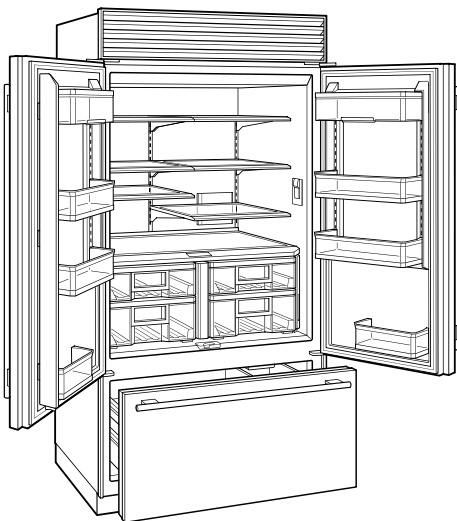

This illustration is intended for interior reference only and may not represent the exterior of the model being specified.

STANDARD INSTALLATION

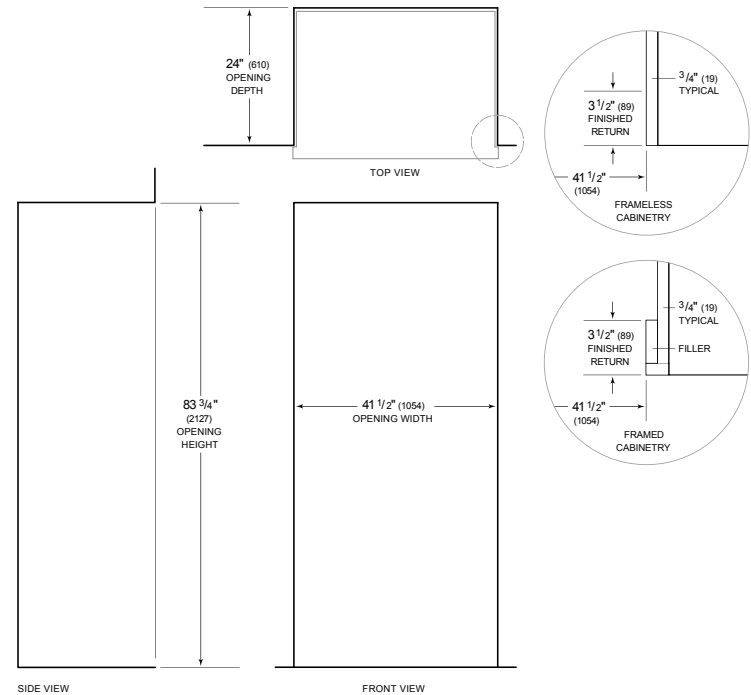

NOTE: 3 1/2" (89) finished returns will be visible and should be finished to match cabinetry. Shaded line represents profile of unit.