

WINNERS ONLY®

ASSEMBLY INSTRUCTIONS







PROD. NO : DH44096N-T&B

Thank you for purchasing this quality product. Be sure to check all packing material carefully for small parts that may have come loose inside the carton during shipment.



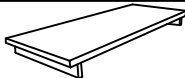







Please keep all hardware parts out of the reach of children.

1. We recommend that you should assemble this product with the assistance of another person; this will make the assembly easier, and will help to prevent personal injury and to insure parts are not damaged during the assembly process.
2. Before beginning, please check the packing materials carefully for small parts which may have come loose inside the carton during shipping. Please do not discard any packing material until all parts have been located. If any parts are missing, please contact your dealer for prompt replacement.
3. To prevent damage to your floor or carpet, please check the bottom of each piece of furniture for stain residues and rough surfaces and also check for staples or nails left after removing the packing materials. The manufacturer will not be held responsible if preventive steps are not taken prior to installation.
4. Please do not over tighten screws or bolts. During normal use everyday, screws, bolts, nuts and wooden plugs may loosen up. They should be periodically inspected and re-tightened to prevent damage to the furniture and (or) personal property or cause injury. Always check to be sure all hardware on this list and the below mentioned components are attached to the furniture properly and kept tightened.
5. Please lay all parts and hardware on a non abrasive surface such as a carpet, and follow the assembly steps.

Components List :

NO	DESCRIPTION	SKETCH	QTY	NO	DESCRIPTION	SKETCH	QTY
A	Table Top		1pc	E	Base Leg		2pcs
B	Pedestal		2pcs	F	Center Leaf		1pc
C	Pedestal Side		4pcs	G	Mounting Plate		2pcs
D	Center Structure		2pcs				

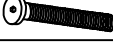
Hardware List :

NO	DESCRIPTION	SIZE	SKETCH	QTY
1	Flat Washer	$\frac{5}{16}$ " x 22 mm		16pcs
2	Spring Washer	$\frac{5}{16}$ "		16pcs
3	JCBC Bolt	M8 X 80mm		6pcs
4	Allen Key	M5		1pc
5	Hexagon Nut	$\frac{5}{16}$ " x 7 mm		8pcs
6	Spanner	12.8 mm		1pc
7	Flat Washer	$\frac{1}{4}$ " x 18 mm		8pcs
8	Spring Washer	$\frac{1}{4}$ "		8pcs
9	JCBC Bolt	M8 X 60mm		2pcs
10	JCBC Bolt	M6 X 50mm		8pcs
11	Allen Key	M4		1pc

Reminders

1. Use only the hardware supplied.
2. Once the chair is finished, level and tighten all the bolts.
3. Do not over tighten bolts.
4. This item may require periodic tightening.

NOTE :

1. Hardware pack is located underneath the Table Top (A).
2. Two or more people are needed for assembly. Please keep all hardware part out the reach of children.

TIP: Store the Allen key and (or)Wrench used in assembly in this product's drawer or use masking or painter's tape to affix it to the underside of the product.This will make it easier to find if you want to periodically tighten bolts or disassemble the product.

WINNERS ONLY®

ASSEMBLY INSTRUCTIONS

PROD. NO : DH44096N-T&B

Step 4 * POWER TOOLS ARE NOT RECOMMENDED.

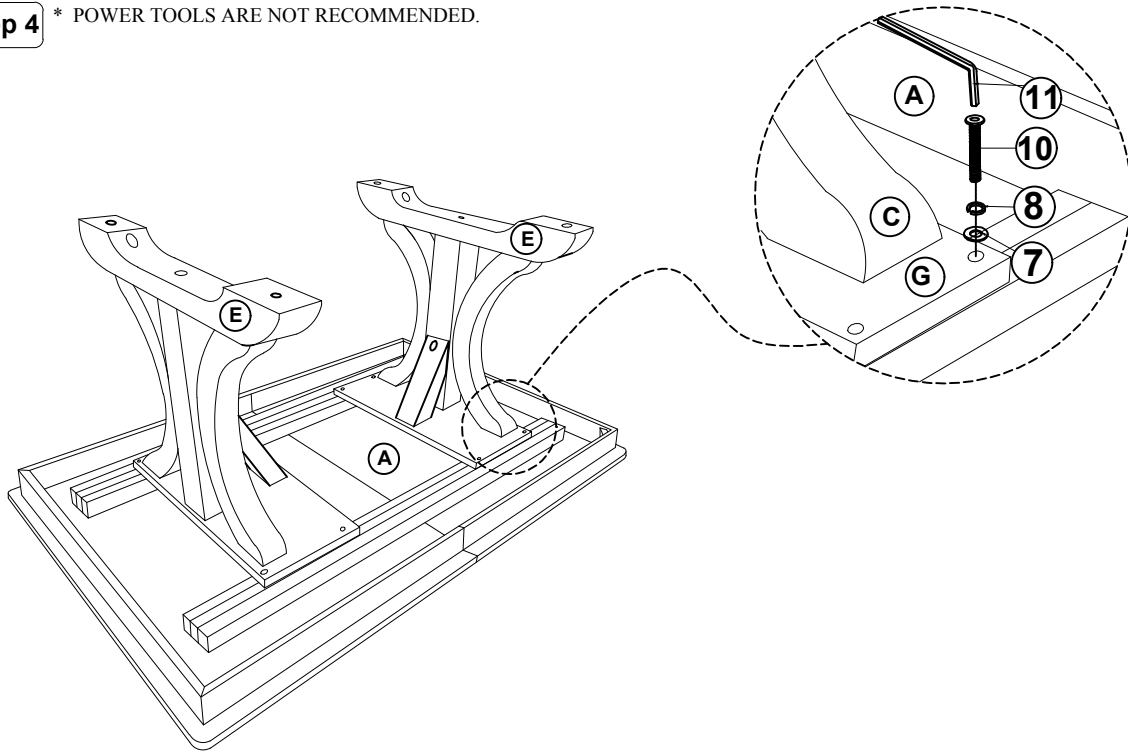

Step 5

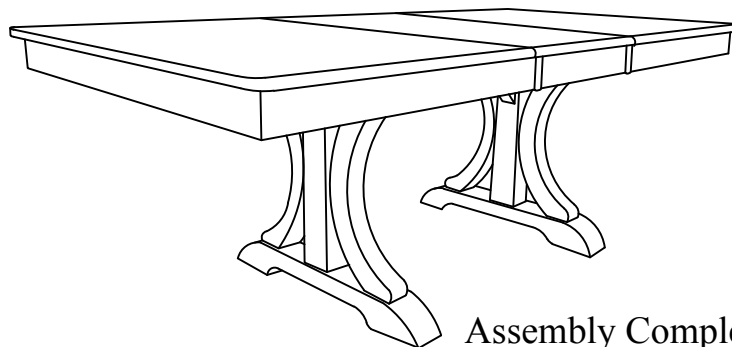
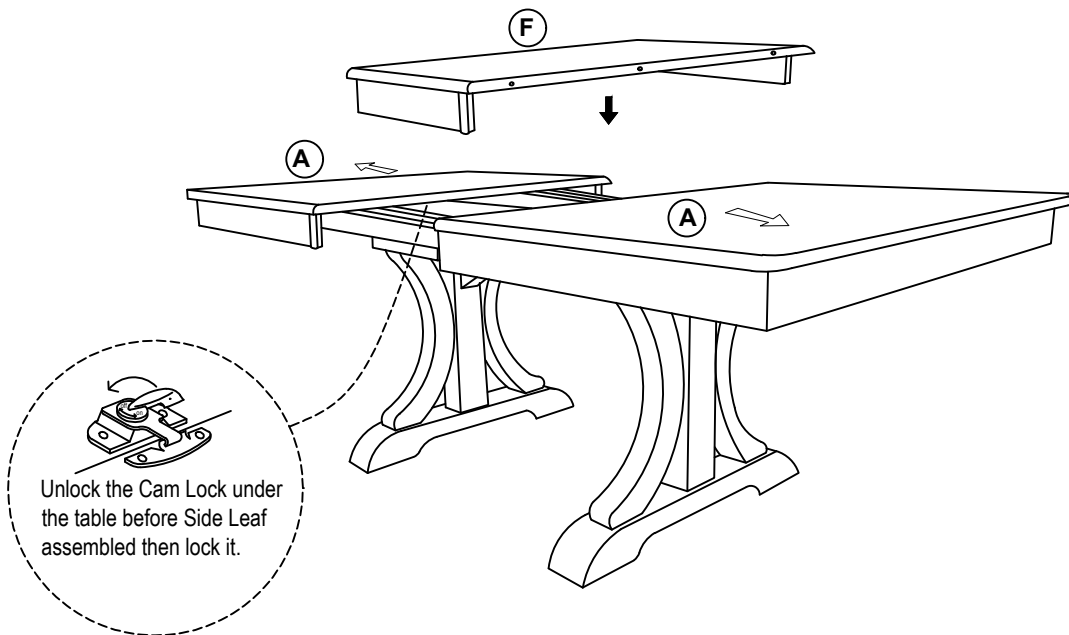

Assembly Completed !