



AGA DUAL CONTROL

Model No. - DC3 & DC5

Users Instruction

PLEASE READ THESE INSTRUCTIONS BEFORE USING THIS APPLIANCE

IMPORTANT : SAVE INSTRUCTIONS FOR FUTURE REFERENCE

IMPORTANT : CONSERVER CES INSTRUCTIONS POUR REFERENCE FUTURE

For use in USA/Canada

12/14 EOP1 516662

My AGA Details

AGA Dual Control (DC3 & DC5)

Serial No _____

AGA Service No _____

Date of Installation _____



DATA PLATE LOCATED
BEHIND REMOVABLE PLINTH

Contents

Product Safety	4
Important Safety Instructions	5
Serial Number	6
Health and Safety	6
Introduction	7
A Brief Description - AGA DC3	8
A Brief Description - AGA DC5 (Hot Cupboard Option)	9
Equipment Supplied with your AGA Dual Control	10-11
Operating the AGA Dual Control	12
Thermostat Control - Oven	12
The Heat Indicator	13
The Roasting Oven	14
The Baking Oven	14
The Slow Cook Oven	15
AGA DC5 Hotcupboard Option	16
The Top Plate	17
The Hotplates	17
Hotplate Control	17
The Boiling Plate	17
The Simmering Plate	17
General Advice	18
Guide to AGA Cooking	19
Fitting of Oven Shelves	20
Removal of Oven Shelves	20
Fitting and Removal of Oven Doors	20
Caring and Cleaning	21
Enamelled Cast Iron	
Enamelled Cookware	
Cast Iron Ovens and Hotplates	
Lids and Oven Doors/Lid Linings	
Servicing and Warranty	

PRODUCT SAFETY

MEANING/DESCRIPTION	SYMBOL	SIGNIFICATION/DESCRIPTION
<p>WARNING/CAUTION</p> <p>An appropriate safety instruction should be followed or caution to a potential hazard exists.</p>		<p>AVERTISSEMENT</p> <p>Une consigne de sécurité appropriée doivent être suivies ou garde d'un danger potentiel exists.</p>
<p>DANGEROUS VOLTAGE</p> <p>To indicate hazards arising from dangerous voltages.</p>		<p>TENSION DANGEREUSE</p> <p>Pour indiquer les dangers résultant des tensions dangereuses.</p>
<p>PROTECTIVE EARTH (GROUND)</p> <p>To identify any terminal which is intended for connection to an external conductor for protection against electric shock in case of a fault, or the terminal of a protective earth (ground) electrode.</p>		<p>TERRE DE PROTECTION</p> <p>Pour marquer bornes destinées à être raccordées à un conducteur de protection extérieur contre les chocs électiques en cas de défaut d'isolement, ou pour marquer la borne de la terre de protection.</p>
<p>HEAVY</p> <p>This product is heavy and reference should be made to the safety instructions for provisions of lifting and moving.</p>		<p>LOURD</p> <p>Ce produit est lourd et doit être fait référence aux consignes de sécurité relatives aux dispositions de soulever et déplacer.</p>
<p>DISCONNECT MAINS SUPPLY</p> <p>Disconnect incoming supply before inspection or maintenance.</p>		<p>APPAREIL À LASER DE CLASSE 2</p> <p>Alimentation d'entrée Débrancher avant inspection ou d'entretien.</p>
<p>REFER TO MANUAL</p> <p>Refer to relevant instructions detailed within the product manual.</p>		<p>ATTENTION, SURFACE TRÈS CHAUDE</p> <p>Reportez-vous aux instructions applicables, indiquées dans le manuel du produit.</p>

IMPORTANT SAFETY INSTRUCTIONS



INCORRECT USE OF THIS RANGE CAN INCREASE THE RISK OF FIRE, ELECTRIC SHOCKS OR INJURY TO PERSONS.

PLEASE READ THE FOLLOWING PRECAUTIONS TO REDUCE THESE RISKS.

This appliance is not intended for use by persons (including children) with reduced physical, sensory or mental capabilities, or lack of experience and knowledge, unless they have been given supervision or instruction concerning use of the appliance by a person responsible for their safety.



ALWAYS

Always make sure children are never left alone or unsupervised when the range is on.

Always be aware that range surfaces will be hot during and after use and can cause burns.

Always teach children that the range and utensils can be hot.

Always allow heavy and hot utensils to cool in a safe place and out of reach of small children.

Always be aware hot grease is flammable. Wipe off any grease deposits on the range top and front.

In the event of a grease fire, do not remove the pan, cover the pan to extinguish the flame.

Always turn utensil handles inwards but not cover adjacent heated surfaces, to prevent accidental spillage and burns.

Always when opening an oven door, allow hot air and steam to escape.

Always use dry pot holders. Moist pot holder will cause steam burns. Do not use towels or other cloths near the heated plates.

Always clean ventilation hoods frequently. grease should not be allowed to accumulate in hood and filters.

Always make sure cabinet and work surface are capable of supporting heavy cooking utensils used on your range.

Always make sure cooking utensils are suitable for range top service. Only certain types of glass, glass ceramic earthenware/glazed utensils with stand sudden temperature changes without breaking.

Always make sure your appliance is properly installed and grounded by a qualified technician.

Always make sure your appliance is serviced by a qualified technician.



NEVER

Never store items of interest to children above the range.

Never allow children to climb on, sit or stand on any part of the range.

Never allow children to play with the controls or any part of the range.

Never wear loose fitting clothing or other flammable materials that could contact hot surfaces on the range.

Never leave boiling pans unattended, boil over causes smoking and greasy spillovers may ignite.

Never store gasoline or other volatile liquids in the range or in cabinets above or near the range, which can catch fire or explode.

Never use water on grease fires. Smother fire or flame or use a dry chemical or foam type extinguisher.

Never use your appliance for warming or heating the room.

Never repair or replace any part of the appliance unless recommended in this manual. All other servicing should be carried out by a qualified technician.

Never cover or restrict the air flow to the controls compartment.

Never install cabinets (shelves) or similar above the range with a depth greater than 13" (330mm).

Never heat unopened food containers. Pressure build-up may cause the container to burst and cause injury.

Never reach directly into a hot oven to add or remove cooking utensils. Instead pull the grid shelf out to its maximum projection.

Never use a steam cleaner to clean your range.

Never use a power spray or oven cleaners on the control panel.

Never use caustic cleaners, abrasive pads or metal scrapers to clean enamel surfaces.

Serial Number

Make a note of your AGA Dual Control Serial Number when it is being installed. The serial number can be found behind the magnetic plinth.

 A little smoke and some odour may be emitted when the range is first switched on. This is normal and harmless from oven lagging and starch binder on the element insulation and will cease after a short period of use.

Health & Safety

Consumer Protection

As a responsible manufacturer, we take care to make sure that our products are designed and constructed to meet the required safety standards when properly installed and used.

Deep Fat Frying

IMPORTANT

- Use a deep pan.
- Never fill the pan more than one-third full of fat or oil.
- Never use a lid on the pan.
- Important: Oil is a fire risk, do not leave pans containing oil unattended.
- In the event of a fire, cover the pan with a lid and turn OFF the appliance.

Smother the flames on the hob preferably with a fire blanket, rather than attempting to remove the pan to the outside.

Burns and injuries are caused almost invariably by picking up the burning pan to carry it outside.

- **Do not hang clothes on the left hand side of the AGA hand-rail. The electrical controls are behind the top left hand door, blocking the air vent can cause excessive control temperatures, and will prevent easy access to the controls.**

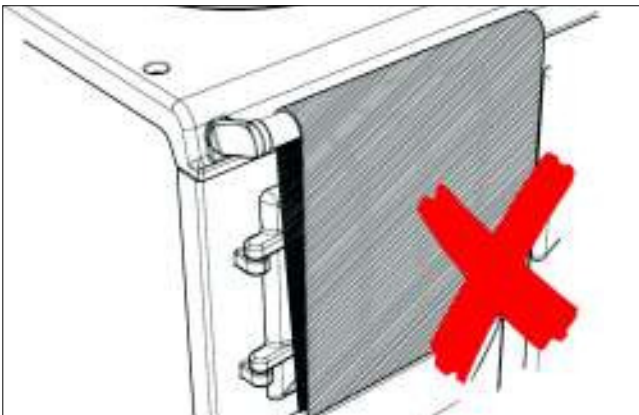

 When the oven (s) are on **DO NOT** leave any oven door open for long periods, this will affect the temperature of the oven and may allow controls to become hot.

Introduction

Your new AGA Dual Control give you everything you love about the AGA heat storage range, but with the added convenience that two hotplates can be turned on or off, as required.

Made in the heart of Shropshire in the United Kingdom, your AGA range, like the generations of ranges before it, has been manufactured from cast iron at the Coalbrookdale Foundry. Traditional iron-making skills combined with industrial strength hotplate elements enable the hotplates to heat up rapidly, so you can have them both on, or just one on, depending on the time of day or the size of your family.

The cooking excellence of the AGA range has been famous since its inception in the 1920's and is renowned due to the indirect radiant heat that its cast iron emits rather than just air temperature. And, if you haven't found out already, you'll soon discover that food that is cooked this way retains its natural flavour and succulence, and simply just tastes better.

So grab a cup of tea or coffee, have a read and prepare to dig into some of the tastiest dishes you're ever likely to make.

A Brief Description - AGA DC3

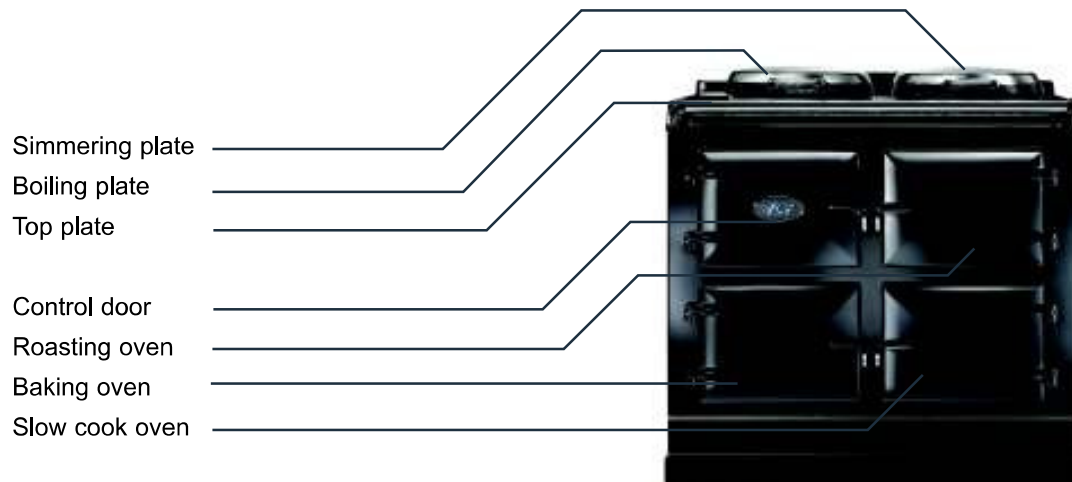

The AGA Dual Control has the traditional cast iron ovens with independently controlled hotplates.

Hotplates

The two hotplates are at different heats; the boiling plate being the hottest of the two and the simmering plate is a lower heat. Each plate is individually controlled.

Boiling Plate

The boiling plate is used for making toast, boiling a kettle, stir-frying and cooking at a higher heat.

Simmering Plate

The simmering plate is for slower cooking, such as sauces, simmering pans and can also be used direct on for toasted sandwiches, drop scones, no-fat fried eggs and quesadillas.

Roasting Oven

The hottest oven for high temperature cooking; pastries, breads, roasting of meat, vegetables and poultry, broiling at the top of the oven and frying on the floor.

Baking Oven

A moderate oven for cooking cakes and biscuits, baking fish, lasagne or shepherds pie, plus roasting meat and poultry at a medium heat. Cooking sweets and savoury together is no problem as the flavours do not mix.

Slow Cook Oven

Long, slow cooking in the simmering oven develops flavors and makes the toughest meat tender. It's large capacity means several pans can be stacked here; soup, casserole, steamed rice, steamed carrots and poached pears all cooking simultaneously, without any danger of burning.

NOTE: From cold the roasting, baking or slow cook ovens will take several hours to achieve normal operating temperature.

A Brief Description - AGA DC5 (Hotcupboard Option)



The AGA Dual Control has the traditional cast iron ovens with independently controlled hotplates.

Hotplates

The two hotplates are at different heats; the boiling plate being the hottest of the two and the simmering plate is a lower heat. Each plate is individually controlled.

Boiling Plate

The boiling plate is used for making toast, boiling a kettle, stir-frying and cooking at a high heat.

Simmering Plate

The simmering plate is for slower cooking, such as sauces, simmering pans and can also be used direct on for toasted sandwiches, drop scones, no-fat fried eggs and quesadillas.

Warming Plate (Hotcupboard)

The warming plate is the ideal resting place for cooked food.

Simmering Oven (Hotcupboard)

Ideal for a broad range of long slow cooking applications, such as leg of lamb, pulled pork, belly pork and celebration cake.

NOTE: Meat and vegetable dishes should be started on the boiling plate or in the roasting oven.

Warming Oven (Hotcupboard)

Used for warming plates and serving dishes. Can also be used for resting joints before carving.

Roasting Oven

The hottest oven for high temperature cooking; pastries, breads, roasting of meat, vegetables and poultry, broiling at the top of the oven and frying on the floor.

Baking Oven

A moderate oven for cooking cakes and biscuits, baking fish, lasagne or shepherds pie, plus roasting meat and poultry at a medium heat. Cooking sweets and savoury together is no problem as the flavours do not mix.

Slow Cook Oven

Long, slow cooking in the simmering oven develops flavors and makes the toughest meat tender. It's large capacity means several pans can be stacked here; soup, casserole, steamed rice, steamed carrots and poached pears all cooking simultaneously, without any danger of burning.

NOTE: From cold the roasting, baking or slow cook ovens will take several hours to achieve normal operating temperature.

Equipment supplied with your AGA Dual Control



Large Size Roasting Tin with Broiling Rack

This is designed to slide onto the oven runners without the need for it to sit on an oven grid shelf. The roasting tin can be used with the broiling rack, in its high position, for broiling at the top of the roasting oven. It can be used for roasting meat, or poultry with or without the broiling rack. Large quantities of roast potatoes can be cooked in this tin. The roasting tin can also be used for making large brownies or cakes. The broiling rack is useful on its own as a cake cooling rack. Can be used in any oven but not recommended for hotplate use.



Half Size Roasting Tin and Broiling Rack

This tin can be slid onto the oven runners width-ways or can sit on an oven grid shelf. The half size roasting tin can be used with the broiling rack, in its high position, for broiling at the top of the roasting oven. It can be used for roasting smaller joints of meat, or poultry with or without the broiling rack. Roast potatoes can be cooked in this tin. The roasting tin can also be used for making brownies or cakes. The broiling rack is useful in its own as a cake cooling rack. Can be used in any oven but not recommended for hotplate use.



3 Oven Grid Shelves

These are for inserting in each oven to provide a surface for dishes and tins which do not fit direct onto the oven runners. They can be used in any oven as required. See Page 20 on how to locate the oven shelves correctly.



1 Cold Plain Shelf

Known as the cold plain shelf because it is recommended this shelf should be kept out of the ovens when not in use. It has two uses one as a large baking sheet for scones, biscuits, pastry items and meringues and the other use as a heat deflector to cut off the top heat if food is overbrowning before it is cooked through.



Baking Oven Baffle

A baking oven baffle is positioned at the top of the oven, in order to optimise cooking performance. For best results, please ensure it is in place at all times, while the oven is in operation. The Installation Engineer will fit this in place. This can also be removed for cleaning.



Toaster

This is for toasting bread on the boiling plate. AGA toast is renowned for its excellence, crisp on the outside and soft in the centre. Take thick slices of bread and place in the AGA toaster - if the bread is very moist or very fresh, heat the toaster beforehand to prevent sticking - lift the boiling plate insulated cover and place the toaster direct onto the plate with the handle at an angle from the handle of the cover.

Close the cover and wait for the bread to toast one side - this will take 1-2 minutes dependent upon the variety of bread - open the cover and turn the toaster over and repeat the process to toast the other side. The toaster can also be used for heating pitta bread, toasting teacakes and as a cake cooling rack.



Wire Brush

This is for cleaning the raw cast iron surfaces, keeping them clear of crumbs and burnt on debris – which would otherwise affect the boiling performance of pans and the kettle. Use on the hotplates and the ovens. Take care not to touch the enamel surfaces as the wire brush will scratch the finish.



AGA Utensils and Accessories

To get the very best performance from your cooker we recommend AGA saucepans with the thick tri-core bases and stacking lids so that the maximum use of oven space is made and an AGA kettle for boiling water. AGA Accessories can be viewed at your AGA Specialist or online at www.agamarvel.com



Getting to know your AGA

If you have not already seen a demonstration, ask your AGA Specialist for details. A demonstration will show you how to get the best from your new AGA and will give you hints and tips. You will also see a selection of AGA utensils and accessories being used.

Operating the AGA Dual Control

The different zones of the AGA Dual Control range are described in the following pages.

The traditional AGA heat storage range is famous for the gentle warmth it emits, with the AGA Dual Control you will get warmth only when the range is on or warmth, to a lesser degree, when only parts of it are on.

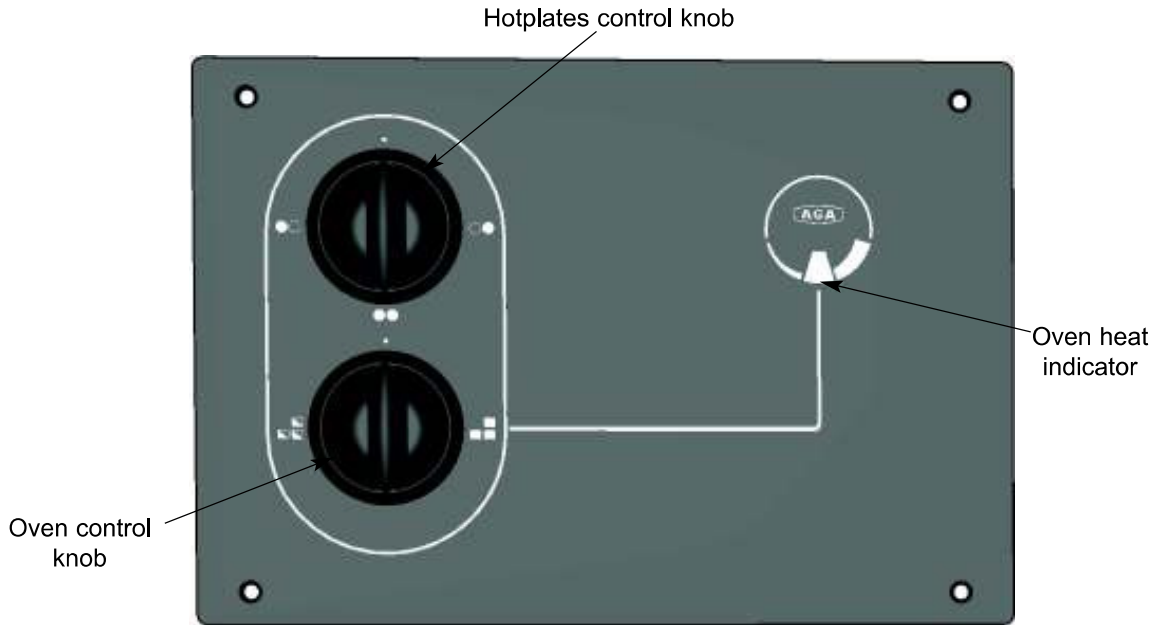

Thermostat Control - Oven

Your AGA Dual Control has three ovens, each of which is pre-set at a different heat. They are named as:

The Roasting Oven
for high temperature cooking

The Baking Oven
for moderate temperature cooking

The Slow Cook Oven
for long, slow cooking

DO NOT OPERATE THE APPLIANCE WITH THE DOORS OPEN.

Each oven has the same capacity, (able to fit a 13kg (28lb) turkey). The AGA heat storage range techniques can be used such as stacking of saucepans in the simmering oven. This enables the steaming of root vegetables, rice, steamed pudding, casserole, poaching fruit all in the one oven leaving the hotplates free.

The ovens are made from cast iron, which cooks by radiant heat, and this is the secret of the cooking excellence for which the AGA cooker is renowned. An indirect radiant heat does not dry food out, so it retains its natural moisture and flavour.

When the ovens are in use the oven control knob should be in the  section.

A second position  is available which lowers all oven heat to reduce energy consumption.

To achieve normal cooking temperature, return the control knob to  section approximately 3 hours before intended use.

The Heat Indicator

The heat indicator is a guide to the stored heat within the AGA, and does not directly relate to the temperature of the roasting oven.

An AGA is designed to work at an optimum heat setting by cycling between two fixed temperatures.

The optimum performance is usually achieved when the indicator displays the colour green. For best cooking performance wait until the AGA contains the full amount of stored heat, which is indicated by the window being completely filled with the colour green (Fig.1). This may take some time to achieve and can take approximately 2 – 3 hours between use for full recovery.

NOTE! Because of the temperature cycling, the green band will move and only be partially visible at times. This is perfectly normal (Figs. 2 - 4). Cooking can be started during this part of the cycle but it may take longer to achieve the desired result.

The lower temperature is indicated by the colour amber and cycles in the same way as full power (Fig. 5).



Fig. 1

Full green indicates 'ready to use'



Fig. 2



Fig. 3

Normal movement during cycling



Fig. 4



Fig. 5

Amber indicates low temperature setting. (Movement will also be seen with this setting).

The Roasting Oven



The roasting oven can be used for 'broiling' at the top and 'shallow frying' on the oven floor.

The roasting oven is zoned in heat, meaning it is slightly hotter towards the top than the centre and the oven grid shelf set on the oven floor is slightly less hot than the centre.

The floor of the oven can be used as another cooking surface, indeed it is often called the hidden hotplate.

The beauty of the roasting oven is that any fat splashes are burnt off when the oven is at full heat, just brush out occasionally to get rid of carbon deposits.

The roasting oven is excellent for bread and pastries. Quiches in ceramic or pies in Pyrex dishes need not be baked blind as when they are placed on the floor of the oven the pastry cooks from underneath and the filling will set and brown from the all-round heat. As you are aware metal flan tins conduct heat quicker than ceramic so to avoid over-base browning, you may need to move them up the oven.

The specially designed roasting tins and bakeware slide directly onto the runners, so almost every available square inch of space can be used. Food can be protected by the use of the cold plain shelf or shielded by means of the large roasting tin, which means that you can cook food that requires different temperatures at the same time. If food is browning too quickly and you do not want to move it to another oven just slide the cold plain shelf over the food to reduce the top heat.

The Baking Oven



This oven is set at a moderate heat, so is ideal for cakes, biscuits; also anything that requires medium heat cooking such as fish pie, lasagne, soufflés, crumble and roulades. Meat and poultry can be cooked here in fact most things that can be cooked in the roasting oven can be cooked in the baking oven but for a longer time.

Cook cakes together on one shelf, if two shelves are used interchange the food to achieve even colouration, as you would with any oven which is zoned in heat.

As with the roasting oven the specially designed roasting tins and bakeware slide directly onto the runners, so almost every available square centimetre of space can be used. Food can be protected by the use of the cold plain shelf or shielded by means of the large roasting tin, which means that you can cook food that requires different temperatures at the same time.

If food is browning too quickly and you do not want to move it to another oven just slide the cold plain shelf over the food to reduce the top heat.

When using the roasting oven for a long period of time i.e. a full meal, the baking oven temperature may rise, it will therefore be necessary to adjust the cooking procedure, the following suggestions may prove useful.

1. When placing the food in the baking oven, ensure the cold plain shelf is set directly above the dish, for the whole of the cooking time.
2. In addition it may be necessary to lower the shelf position.
3. When baking food, such as very rich fruit cakes, which require a long period of cooking time, place the cake on the fourth grid shelf position of the oven with the cold plain shelf set directly above for 3/4 hour approximately. Move the plain shelf to the middle of the simmering oven. Transfer the cake to this shelf and bake until cooked through.
4. Alternatively, allow the baking oven to cool for approximately 4 hours before using.

NOTE: A loose metal perforated plate is positioned in the top of the baking oven in order to optimise cooking performance. It must remain in place at all times while the cooker is in operation.

The Slow Cook Oven



The slow cook oven can be described as a continuation oven, it continues to cook food that has been brought up to heat elsewhere on the cooker with the exception of meringues which are dried out rather than 'cooked'.

User Guidance

- To get the very best performance, we recommend the use of AGA cookware with thick bases and stacking lids.
- Joints of meat and poultry should be brought up to heat ideally in the roasting oven for 30 - 45 minutes, then transfer to the simmering oven.
- This method is unsuitable for stuffed meat and poultry.
- Make sure that pork and poultry reach an internal temperature of at least 167°F (75°C).
- Always bring soups, casseroles and liquids to the boil before putting in the oven.
- Always thaw frozen food completely before cooking.
- Root vegetables will cook better if cut into small pieces.
- Adjust seasonings and thickenings at the end of the cooking time.
- Many dried legumes and beans for example, dried red kidney beans must be boiled for a minimum of 10 minutes, after soaking, and before inclusion in any dish.

AGA DC5 (Hotcupboard Option)

Simmering Oven plus Warming Oven

These ovens are heated by a single element at the rear of the oven cavity by a single push ON-OFF button located on the left hand side of the hotcupboard top plate and can be turned ON and OFF when required.

Simmering Oven

This oven delivers a gentler convected heat making it better suited for longer cooking times especially for overnight cooking, for example rich fruit cakes and celebration cakes. The cooking of meringues may also be better suited for this oven.

Points to remember when simmering:

- Pre-heat the ovens for 30 minutes before starting to cook.
- Bring casseroles, soups etc. to the boil on the hotplate and meats start in the roasting oven, before placing in the slow cooking oven.
- Make sure that casseroles have sufficient liquid, particularly when cooking over a long period.
- Use lids on casseroles or foil to cover food whilst it is cooking to retain moisture.
- Make sure all dishes will fit into the oven before preparing food.
- Make sure that meat and poultry is piping hot before eating.
- Always thaw frozen food completely before cooking.

You can also produce crisp, white meringues cooked in the slow cooking oven.

Timings for cooking in the simmering oven will depend upon the temperature, quantity and type of dish you are cooking, as a guide for casseroles, a minimum of 3 hours cooking time is recommended.

Keep an eye on the food until you are familiar with the oven.

The Top Plate

The top plate is the enamelled surface surrounding the hotplates. It will become warm when the AGA Dual Control hotplates are in use. Although it is not a cooking surface you can use the warmth for a number of useful activities, which more often than not saves time and washing-up! These include warming honey or syrup in the jar, or melting butter or chocolate in a basin - so saving on melting over a saucepan - but do please put the basin on a cork mat or folded piece of kitchen towel to avoid scratching the enamel. Although it is a durable and hard-wearing surface vitreous enamel is glass and will show scratch marks!

The top plate when warm can also be used to rest a cup of coffee or tea or dry off awkwardly shaped tins, peelers or food mixer and processor parts.

The Hotplates

The hotplates are operated manually.

The boiling plate is on the left hand side and the simmering plate is on the right hand side of the AGA Dual Control. The boiling plate is the hottest with the simmering plate being the cooler of the two. They both have electric elements embedded into the cast iron which heat up in approximately 11 and 8 minutes respectively. The hotplates can be used completely independently from the ovens.



This means the AGA Dual Control differs from the traditional AGA heat storage cooker in that they can be used for the entire cooking time of appropriate dishes because the design keeps the hotplates at a constant heat, whereas the traditional AGA range continues to cook on a falling heat so for these we recommend starting on the hotplate(s) then transferring to the ovens, this can be done with the AGA Dual Control but is not necessary. For instance, if making a pasta dish with sauce on the AGA Dual Control, it can all be done on the hotplates.

The whole hotplate area can be used for cooking and several pans can be accommodated on a single plate at any one time. The hotplates are set very slightly above the top plate to avoid accidental scratching if the pans are pulled to one side. Do not drag the utensils from one plate to another as the enamel will suffer!

The stainless steel insulated covers are brought down over the hotplates when they are not in use. When the hotplates are 'on' the insulated covers will be warm. We **strongly advise** not to put anything such as kettles, saucepans or baking tins directly onto the insulated covers because they will show any scratches – invest in a pair of chef's pads to protect the surface if the covers are to be used as resting places!

Keep the hotplates clear of any burnt on food or crumbs by brushing with the wire brush, supplied with your AGA. Cleaning details can be found on Page 21.

Hotplate Control

To operate the boiling plate turn the control knob to  position and similarly to the  for the simmer plate.

To turn both plates on turn knob to  position.

The Boiling Plate

The hottest hotplate, the boiling plate is used for boiling, grilling, stir-frying, making toast - indeed anything that requires a high heat. Green vegetables keep their colour when boiled quickly here, or use a steamer over the saucepan to cook more than one vegetable at once.

When stir-frying or cooking anything that is inclined to splash we would recommend using an AGA Splash Shield which will protect the insulated cover from splatter, making cleaning easy! Just wash the Splash Shield in hot soapy water or place in a dishwasher between two dinner plates.

Please be advised the boiling plate is too hot to cook food directly on it.

The Simmering Plate

The simmering plate is the cooler of the two hotplates and so is used for recipes that require a lower heat such as, making sauces, scrambling eggs, heating milk, slow frying, simmering soups and root vegetables. In addition, it can be used to cook on directly as a form of griddle - invaluable for toasted sandwiches, quesadillas, drop scones, searing scallops and even a non-fat fried egg! Slow cooked toast can be made on the simmering plate, no need here to use the AGA toaster.

The same size as the boiling plate, the simmering plate is also machined flat to give the best all-over contact with the AGA saucepans, grill pan, frying pan and kettle.

Cleaning details can be found on Page 21.



General Advice

When first switched on, the AGA will emit an odour for a short while. This is simply due to protective oil burning off the hotplates. Wipe the inside of the lids whilst the AGA is heating up to avoid a film of this oil being deposited on the inside.

The following points are intended to help in adapting to the AGA style of cooking during the change-over from a previous non-heat storage cooker. The AGA book provides a very useful introduction to the cooker.

For the most effective operation of the cooker, the following points should be carefully observed:

1. Close the insulating covers whenever the hotplates are not in use.
2. Clean the hotplates regularly with the wire brush.
3. Utensils with flat bases must be used to make perfect contact with the hotplate.
4. Take care when closing the oven doors, to lift them onto the catch.
5. Cook as much as possible in the ovens so that heat is conserved and cooking smells and condensation are reduced.
6. The oven doors should not be left open for long periods of time during cooking and heating up.

The roasting oven can also be used for 'broiling' and 'shallow frying' on the oven floor.

- For optimum cooking performance, use the AGA utensils and cast iron cookware. They have flat bases which give the best contact with the hotplates.
- The AGA pans can be stacked in the simmering oven. This is especially useful for steaming vegetables and keeping sauces warm.
- Store the plain shelf out of the AGA. Use it cold in the roasting oven to deflect the heat from the top of the oven, creating a more moderate oven temperature underneath. It can also be used as a baking sheet.
- A guide to AGA cooking is given on Page 19. Visit www.agamarvel.com to learn more about upcoming AGA demonstrations and much more.

Guide to AGA Cooking

Below is a quick guide to oven usage

AGA OVENS

ROASTING OVEN

- Grilling
- Scones
- Pastries
- Bread
- Yorkshire puddings
- Roasts
- Shallow frying

BAKING OVEN

- Cakes
- Biscuits
- Fish
- Shepherds pie, Cottage pie
- Lasagne
- Soufflés
- Shortbread

SLOW COOK

- Casseroles
- Stock
- Milk puddings
- Meringues
- Rich fruit cake

OVEN TEMPERATURE

HIGH

- **Top** - grilling
- **2nd runner** - scones, small pastries, grilling
- **3rd runner** - bread rolls , Yorkshire pudding
- **4th runner** - roasts, poultry
- **Oven grid shelf on base of oven** - bread loaves, pies, roast vegetables
- **Floor grid on base of oven** - quiches, pies

MODERATE

- **Towards top** - whisked sponges, some biscuits, small cakes
- **Middle** - fish, soufflés, shepherd and cottage pie, lasagne
- **Oven grid shelf on base of oven** - Victoria sandwiches, shortbread, traybakes and cheesecake

LOW

For casseroles, stock, milk puddings and similar dishes bring to heat elsewhere on the AGA then transfer to the simmering oven (one exception is meringues). Rich fruit cakes can be cooked here for a, long time on the oven grid shelf placed on the base of the oven.

FITTING OF OVEN SHELVES

When using the oven shelves for the first time follow Figs. 6 - 9.

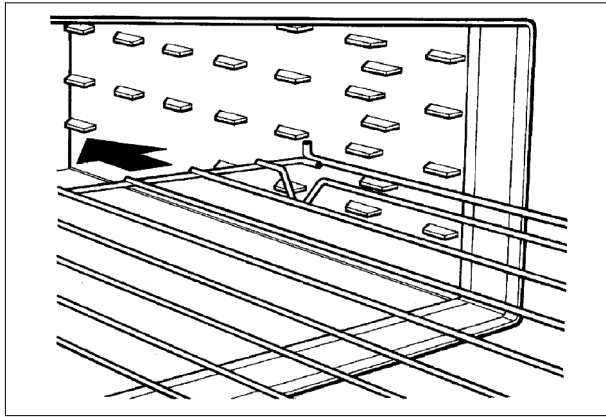

fig 6

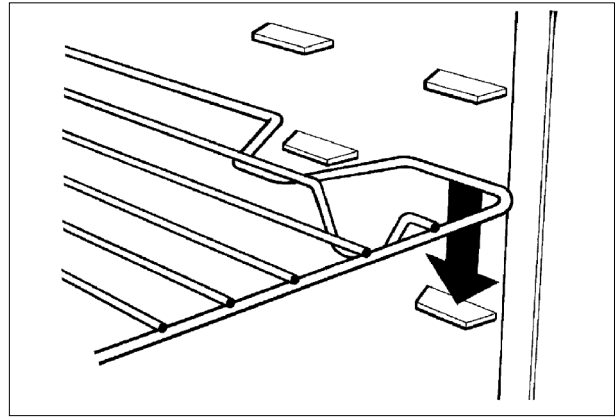

fig 7

REMOVAL OF OVEN SHELVES

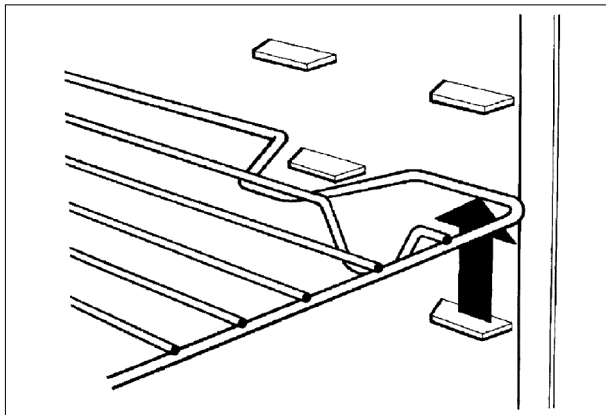

fig 8

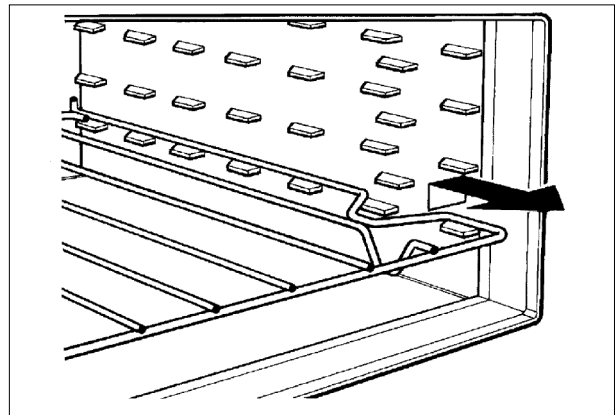

fig 9

FITTING AND REMOVAL OF OVEN DOORS



fig 10 DOOR HINGES LOCATED

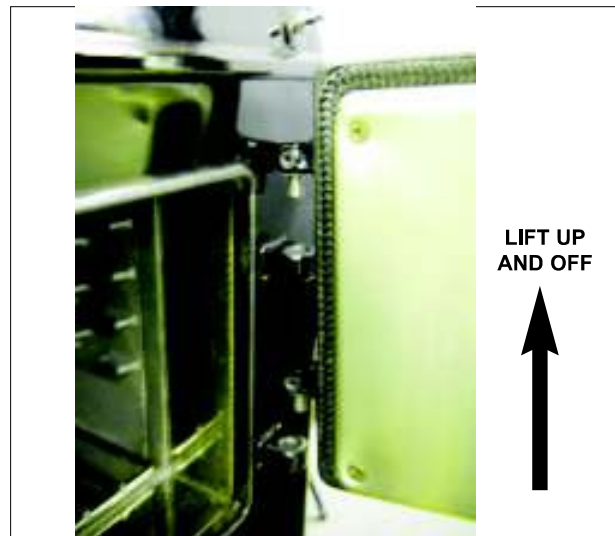







fig 11 ENSURE DOOR IS OPEN BEFORE LIFTING UP AND OFF TO AVOID DAMAGE TO THE ENAMEL

Caring and cleaning

REMEMBER: BE CAREFUL OF THE HOT APPLIANCE.

-  **DO NOT USE A STEAM CLEANER TO CLEAN THIS RANGE.**
-  **DO NOT USE ABRASIVE PADS, CAUSTIC CLEANERS, OVEN CLEANERS OR METAL SCRAPERS TO CLEAN THE SURFACES OF THE ENAMEL.**
-  **FOR MOST CLEANING IT IS BEST WHEN THE APPLIANCE IS TURNED OFF.**
-  **REMEMBER THE TOP PLATE AND THE POLISHED COVERS WILL SCRATCH IF PANS OR UTENSILS ARE DRAGGED ACROSS THEM.**
-  **DO NOT IMMERSE THE DOORS IN WATER AS THEY ARE PACKED WITH INSULATING MATERIAL, WHICH WILL BE DAMAGED BY EXCESSIVE MOISTURE.**
-  **DO NOT PUT OVEN DOORS OR RESTING PLATES IN A DISHWASHER.**

Enamelled cast iron

Top plate, front plate, oven doors and resting plates -

The easiest way to clean the enamelled cast iron parts is to mop up spills as soon as they happen. It may be useful to keep a damp cloth handy to do this. Baked on food is more difficult to clean but can usually be removed with the AGA vitreous enamel cleaner or mild cream cleaners using a damp cloth, or, if necessary a nylon scouring pad. If milk or fruit juice or anything containing acid, is spilt on the range, wipe it up immediately. Clean off any condensation streaks on the front plate around the oven doors or the vitreous enamel maybe permanently discoloured.

To keep the vitreous enamel surfaces of the range bright and clean, a daily rub over with a damp soapy cloth followed immediately with a clean, dry cloth to avoid streaks is all that is required. AGA E-cloths are excellent for this.

Enamelled cookware

Enamelled roasting pans - supplied with the AGA Dual Control should be cleaned in hot soapy water, soaking if necessary. A nylon scouring pad can also be used. They may also be cleaned in the dishwasher, but with constant use, the enamelled finish will become dull in appearance.

Cast iron ovens and hotplates

Ovens - are made from cast iron and keep themselves clean. They are very durable, but will rust if surface moisture is left on them. Remember to always switch the ovens on, to dry them out after cleaning.

Heating up the ovens periodically will help burn off any cooking deposits to aid cleaning within the ovens.

To season the ovens, a light vegetable spray oil (corn oil is best) is recommended. Any stubborn stains can be removed with the wire brush supplied.

Hotplates - are made from cast iron, and are easy to care for. Regular maintenance will ensure long-life. They will rust if surface moisture is left on them

Should the hotplates become soiled, use a sponge, cloth, scouring pad or wire brush to remove burnt-on spills.

Rinse off detergents or cleaning agents thoroughly.

Remember to switch on the hotplates for a few minutes to dry it after cleaning. Every now and then, apply a thin coating of vegetable oil (corn oil is best) when the hotplate is cold.

Lids and oven door/lids linings

The top of the insulated covers (lids) - these are chrome or stainless steel and can be kept clean by wiping over with a damp cloth and polished up - the AGA E-cloths are excellent for this purpose as they are lint-free and eco-friendly. AGA stainless steel and chrome cleaner are recommended to keep the insulated cover clean and shining. These can be purchased from your local AGA retailer.

Lining of the insulated covers (lids interior) - the use of an AGA splash shield is recommended to keep the lining free of fat splashes, (obtainable from your AGA retailer or on-line at www.agamarvel.com).

If the lining is marked it is best cleaned when the hotplate is cold. It can be cleaned with hot soapy water and/or a cream cleanser. If badly marked then a soap impregnated pad can be used - this should be used in a circular motion.

The first few times a soap impregnated pad is used you will see the circular marks, these will become reduced and the surface of the lining becomes shinier each time when used. Do not use excessive water and make sure the lining is dry before closing the cover.

Oven door linings - the linings can be cleaned with hot soapy water, a cream cleanser or soap impregnated pad. To deep clean the lining place a towel on the work surface and carefully lift off the oven door (doors are heavy) and place it enamel side down on the towel padding. Clean with a soap impregnated pad to remove stubborn marks. Dry off before replacing on their hinges.

Servicing & Warranty

- In the event of your appliance requiring maintenance, please contact AGA Marvel or your AGA Retailer.
- Your range must only be serviced by a qualified fitter, from an authorized AGA Specialist.
- Do not alter or modify the range.
- Only the parts specified by the manufacturer, are to be fitted.
- The appliance warranty does not cover Commercial use.

For continued efficient and safe operation of this appliance, it is important that servicing is carried out at regular intervals as recommended by your AGA retailer. The range should be turned OFF in advance of the service so that the appliance will have cooled down sufficiently.

A HOT APPLIANCE CANNOT BE SERVICED.

Warranty

WELCOME

Thank you for choosing an AGA range. We are sure that you will be impressed with the performance of your new AGA range and with the ongoing service you will receive.

PEACE OF MIND

Every new AGA leaving the factory and installed by an AGA approved outlet carries a 5 year guarantee on parts (certain consumable parts are excluded - for full details see below). This also includes all labor charges for the first 12 months.

DISTRIBUTION AND SERVICE NETWORK

AGA has set up an International Distributor and service network with fully trained service specialists available to support your AGA within the guarantee period. The approved outlet installing your AGA is responsible for providing this warranty.

No charge will be made for replacement parts providing:-

- An appliance fault is found.
- The relevant part of the AGA is still covered by the guarantee.
- Regular servicing has been carried out in accordance with the manufacturer's instructions by authorized AGA engineers, using approved spare parts. The service booklet will need to be completed accordingly.

There will be no labor charges during the first 12 months of the warranty.

A service call charge may be applicable if:

- The authorized AGA service specialist who calls at your home finds no fault with the AGA.

- The unit is more than 12 months old.
- If it is deemed the product has been misused.

Please note that invoices for service call repair work carried out during the guarantee period by any third party cannot be accepted.

In the event of an appliance fault during the guarantee period, please contact your service provider. They will arrange for a fitter to call as soon as possible.

What is not included in the guarantee

- Consumable parts
- Any labor charges not directly connected with the repair or replacement of a fault component.
- Any consequential loss.
- Accidental or cosmetic damage.
- Routine preventative service and maintenance.
- Any external controls/components not supplied by AGA.

REGULAR SERVICING

Regular maintenance is an essential part of keeping your AGA range running safely and efficiently.

Since your AGA can operate continuously it is important to ensure regular servicing is undertaken by AGA Service or your authorized AGA Distributor. Only genuine AGA spare parts are used.

Please note that routine servicing in accordance with the manufacturer's instructions is also a condition of the warranty agreement.

To ensure your AGA receives this essential maintenance, please contact AGA Service or your Distributor, who will be pleased to help.

Service Intervals

(Certain models may vary)

Gas and Electric Heat Storage AGA's - every 12 months
Electric 13 amp, AGA - Interim service 2 1/2 years
Dual Control and - Full service 5 years (60 months)
AGA Total Control

**CONSUMABLE PARTS NOT COVERED BY
THIS WARRANTY**

EXCLUSIONS

This warranty does not cover products which have been altered by the customer or by a third party. Materials spare parts and specific tools must be as recommended by AGA.

Warranty does not cover misuse, abuse or impact damage. Corrosion caused by incorrect use of chemical cleaners or stainless steel components by abrasive cleaning materials are also excluded.

Warranty strictly excludes commercial use. Appliances are covered for domestic use only.

This policy applies to products which carry the AGA name plate and trademark.

(AGA utensils and accessories are covered by a separate policy)

Product fuel conversions are not covered.

**THIS WARRANTY POLICY DOES NOT AFFECT THE
OWNER'S STATUTORY RIGHTS**

**For further advice or information contact
your local AGA Specialist**

With AGA Marvel's policy of continuous product improvement, the Company reserves the right to change specifications and make modifications to the appliance described and illustrated at any time.



Supplied by

AGA Marvel
1260 E. Van Deinse St.
Greenville, MI 48838

Business (616) 754-5601
Fax (616) 754-9690
Toll Free Telephone 800-223-3900

www.agamarvel.com