

Assembly instructions for:

Large Base

Part #10521106 (07/12/23)

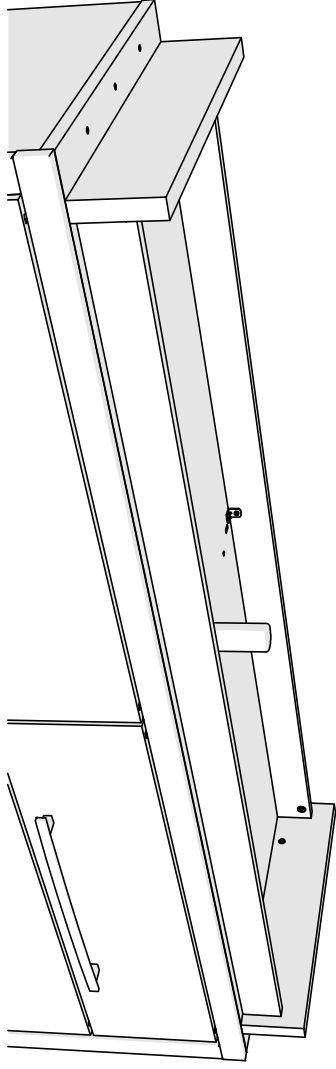

Life doesn't come with instructions, but this does

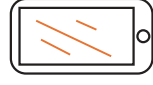

Scan Code for Video Tutorial



HARDWARE

H14 x4

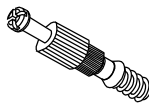

H26 x4

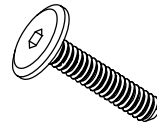

H37 x2



H24

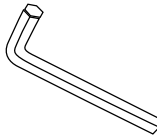

H56 x4

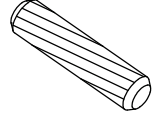

H62 x4



H77 x8

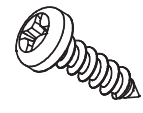

G18 x4

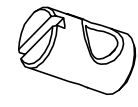

G95

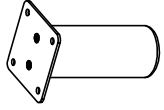

BUST OUT

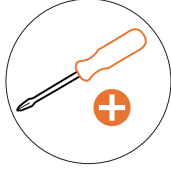

REQUIRED TOOL



This bag contains small parts that present a choking hazard for children under 3 years of age. These parts are for adult assembly only and should be permanently affixed to the furniture. Any unused parts should be discarded properly.

Esta bolsa contiene piezas pequeñas que presentan un peligro de asfixia, para niños menores de 3 años. Estas piezas son para adultos. montaje solamente y debe fijarse permanentemente a la muebles. Las piezas no utilizadas deben desecharse correctamente.

Ce sac contient de petites pièces qui présentent un risque d'étouffement pour les enfants de moins de 3 ans. Ces pièces sont pour adultes montage uniquement et doit être fixé de façon permanente au meubles. Toutes les pièces inutilisées doivent être jetées correctement.

Deze tas bevat kleine onderdelen die verstikkingsgevaar opleveren voor kinderen onder de 3 jaar. Deze onderdelen zijn voor volwassen montage alleen en moet permanent worden bevestigd aan de meubilair. Alle ongebruikte onderdelen moeten op de juiste manier worden weggegooid.

