

# FZU18L



Product family	Freezers
Installation	Built-in
Category	One Door
Reference width	Until 60 cm
Reference height	Higher than 200 cm
Cooling type	No-frost
Hinge	Door-to-door
Hinge position	Left



## Aesthetic

Aesthetics	Panel-ready	Drawers profile color	White
Material	Steel	Display	TFT
Side material	Metal		

## Freezer features



Freezer lighting	Yes
Freezer lighting	LED
Number of drawers	3

## Other Freezer features

Ice maker	Automatico
-----------	------------

## Other technical features



Display functions	Holiday, Fast-freezing, MultiZone, Sabbath	Type of temperature control	Electronic
Fast-freezing button	Yes	No. of compressors	1
Power-on light	Yes	Refrigerant gas type	R600a
Door-open alarm	Yes	Type of compressor	Inverter
Temperature Alarm	Yes	Refrigerant quantity	59 oz
Antibacterial Gasket	Yes		

Metal panel on the back Metal of the fridge

## Performance / Energy Label

Annual energy consumption 480 kWh/year  
 Total net volume 8.19 cu. ft.

Climatic class SN, N, ST, T

## Electrical Connection

Current 2.5 A  
 Voltage 115 V  
 Frequency (Hz) 60 Hz



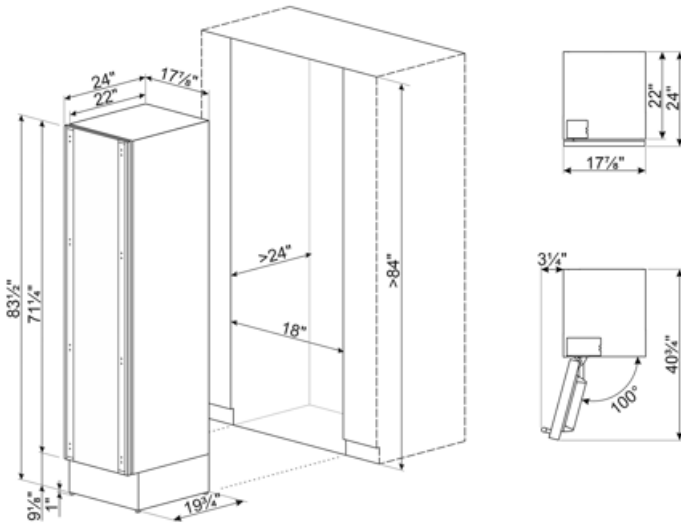



Power cord length 78 3/4 "  
 Plug (B) NEMA 5-15P



---

## Symbols glossary

---

- |                                                                                                                                                                                                                                                                                     |                                                                                                                                                                                                                                                                                                                                  |
|-------------------------------------------------------------------------------------------------------------------------------------------------------------------------------------------------------------------------------------------------------------------------------------|----------------------------------------------------------------------------------------------------------------------------------------------------------------------------------------------------------------------------------------------------------------------------------------------------------------------------------|
|  <p>Fast freezing: The fast freezing function brings the temperature of the compartment down when activated a few hours prior to usage.</p>                                                         |  <p>Power saving mode: The power saving mode allows you to disable the refrigerator and keep the freezer working.</p>                                                                                                                           |
|  <p>LED interior lighting: is a more energy efficient and long lasting way of illuminating the interior of the appliance.</p>                                                                       |  <p>Inverter technology: The evolution of Smeg's driers towards more intelligent and environmentally sustainable models has led to the choice of using Inverter technology with heat pumps, which reduces significantly energy consumption.</p> |
|  <p>Multizone: Multizone compartment can be used as a refrigerator or a freezer compartment. Depending on your needs and eating habits, you can select settings, program the temperature using.</p> |  <p>No Frost: The No Frost and Frost free systems prevent ice from forming so that no defrosting is required.</p>                                                                                                                               |