

SKS

OWNER'S MANUAL RANGETOP

Read this owner's manual thoroughly before operating the appliance and keep it handy for reference at all times.

⚠ WARNING

If the information in this manual is not followed exactly, a fire or explosion may result causing property damage, personal injury or death.

- Do not store or use gasoline or other flammable vapors and liquids in the vicinity of this or any other appliance.
- **WHAT TO DO IF YOU SMELL GAS**
 - Do not try to light any appliance.
 - Do not touch any electrical switch.
 - Do not use any phone in your building.
 - Immediately call your gas supplier from a neighbor's phone. Follow the gas supplier's instructions.
 - If you cannot reach your gas supplier, call the fire department.
- Installation and service must be performed by a qualified installer, service agency, or the gas supplier.

⚠ WARNING

Never Operate the Top Surface Cooking Section of this Appliance Unattended

- Failure to follow this warning statement could result in fire, explosion, or burn hazard that could cause property damage, personal injury, or death.
- If a fire should occur, keep away from the appliance and immediately call your fire department.
- **DO NOT ATTEMPT TO EXTINGUISH AN OIL/GREASE FIRE WITH WATER.**

SKSRT480SIS

SKSRT360SIS



MFL71677601_06

www.sksappliances.com

Copyright © 2020 - 2025 LG Electronics. All Rights Reserved.

TABLE OF CONTENTS

3 IMPORTANT SAFETY INSTRUCTIONS

11 PRODUCT OVERVIEW

- 11 Parts
- 11 Accessories

12 INSTALLATION

- 12 Product Specifications
- 12 Before Installing the Rangetop
- 14 Ventilation Requirements
- 14 Proper Location
- 17 Gas Supply
- 17 Installing the Rangetop
- 19 Connecting the Rangetop to Gas
- 20 Electrical Connections
- 22 Checking Ignition of the Surface Burners

23 OPERATION

- 23 Control Panel Overview
- 24 Changing Settings
 - 24 Sabbath Mode
 - 24 Wi-Fi
 - 24 Smart Diagnosis™
- 25 Using the Cooktop
 - 25 Cooktop Modules
 - 25 Cooktop Timers
- 26 The Gas Surface Burners
 - 26 Before Use
 - 26 Using the Gas Surface Burners
 - 27 Setting the Flame Size
 - 27 In Case of Power Failure
 - 27 Cookware for Gas Burners
 - 28 Extra Low Simmer (Small Burners Only)
 - 28 Using a Wok
 - 28 Using Stove-Top Grills
- 29 Induction Cooktop
 - 29 Benefits of Induction Surface Cooking
 - 29 Induction Cookware
 - 30 Cookware Placement
 - 30 Moving Cookware on the Cooktop
 - 30 Pan Sensing
 - 31 Setting Surface Controls
 - 31 Hot Surface Indicator
 - 31 Using the Cooking Elements
 - 32 Flexible Mode
 - 32 The Recommended Surface Cooking Setting

- 32 Pan Preheat Recommendations
- 33 Noises during Induction Operation
- 33 Power Management
- 33 Sous Vide
 - 33 Vacuum Sealing
 - 34 Using Sous Vide
 - 34 Using the Rack
 - 34 Cooking without Preheating
 - 34 Tips for Sous Vide Cooking
 - 35 Moving the Sous Vide Bath
 - 36 Setting Sous Vide Temperature
 - 36 Setting Sous Vide Cook Time
 - 37 Assembling the Water Bath
 - 37 Filling the Water Bath
 - 37 Sous Vide Cooking Guide

38 SMART FUNCTIONS

- 38 LG ThinQ Application
- 39 Smart Diagnosis™ Function
- 39 Open Source Software Notice Information
- 39 Radio Equipment Specifications
- 40 FCC Notice
- 40 FCC Statement
- 41 FCC RF Radiation Exposure Statement

42 MAINTENANCE

- 42 Control Panel
- 42 Gas Surface Burners
- 43 Burner Grates
- 43 Gas Cooktop Surface
- 44 Sous Vide Module
- 44 Induction Cooktop
- 46 Exterior
- 46 Front Manifold Panel and Knobs

47 TROUBLESHOOTING

- 47 FAQs
- 48 Before Calling for Service

49 WARRANTY

- 49 USA
 - 49 TERMS AND CONDITIONS
 - 49 THIS LIMITED WARRANTY DOES NOT COVER
 - 50 PROCEDURE FOR RESOLVING DISPUTES
- 52 The following circumstances are not covered under the warranty

IMPORTANT SAFETY INSTRUCTIONS

Read and follow all instructions when using the rangetop to prevent the risk of fire, electric shock, personal injury, or damage. This guide does not cover all possible conditions that may occur. Always contact your service agent or manufacturer about problems that you do not understand.

Download this owner's manual at: www.sksappliances.com



This is the safety alert symbol. This symbol alerts you to potential hazards that can result in property damage and/or serious bodily harm or death.

All safety messages will follow the safety alert symbol and either the word WARNING or CAUTION. These words mean:



WARNING - Indicates a hazardous situation which, if not avoided, could result in death or serious injury.



CAUTION - Indicates a hazardous situation which, if not avoided, could result in minor or moderate injury.

INSTALLATION SAFETY PRECAUTIONS

Have the installer show you the location of the rangetop gas shut-off valve and how to shut it off if necessary.



WARNING

- Make sure the appliance is properly installed and grounded by a qualified installer, according to the installation instructions. Any adjustment and service should be performed only by qualified gas range installers or service technicians.
- Make sure the appliance is properly adjusted by a qualified service technician or installer for the type of gas (natural or LP) that is to be used. The appliance can be converted for use with either type of gas. See the installation instructions.
- These adjustments must be done by a qualified service technician according to the manufacturer's instructions and all codes and requirements of the authority having jurisdiction. Failure to follow these instructions could result in serious injury or property damage. The qualified agency performing these adjustments assumes responsibility for the conversion.
- Disconnect the electrical supply before servicing the appliance.
- This product should not be installed below ventilation type hood systems that direct air in a downward direction.
Doing so may cause ignition and combustion problems with the cooktop resulting in personal injury and may affect the cooking performance of the unit.
- To prevent fire hazard or electrical shock, do not use an adapter plug or an extension cord, or remove the grounding prong from the electrical power cord. Failure to follow this warning can cause serious injury, fire or death.
- To prevent poor air circulation, place the appliance out of the kitchen traffic path and out of drafty locations.
- Do not attempt to repair or replace any part of the appliance unless it is specifically mentioned in this manual. All other services should be referred to a qualified technician.
- Make sure that all packaging materials are removed from the appliance before operating it to prevent fire or smoke damage should the packaging material ignite.

SAFETY PRECAUTIONS

Gas appliances can cause minor exposure to four potentially harmful substances, namely benzene, carbon monoxide, formaldehyde and soot, caused primarily by the imperfect combustion of natural or LP gas. Correctly adjusted burners, indicated by a bluish rather than a yellow flame, will minimize imperfect combustion. Exposure to these substances can be minimized by opening windows or using a ventilation fan or hood.

- Do not repair or replace any part of the appliance unless specifically recommended in the manual. All other servicing should be performed by a qualified technician.
- Do not use plastic to cover food. Use foil or oven-safe lids only.
- Do not allow anyone to climb, stand or hang on the rangetop. They could damage the appliance causing severe personal injury.
- **Never use your appliance for warming or heating the room.**
- Always use pot holders or oven mitts when removing food from the surface elements. Cookware will be hot. **Use only dry pot holders.** Moist or damp pot holders on hot surfaces may result in burns from steam. Do not let the pot holder touch hot heating elements. Do not use a towel or other bulky cloth to move cookware.
- **Do not heat unopened food containers.** Pressure in the containers may cause them to burst which may result in injury.
- Leak testing of the appliance must be conducted according to the manufacturer's instructions.
- To eliminate the risk of burns or fire by reaching over heated surface units, cabinet storage space located above the surface units should be avoided. If cabinet storage is to be provided, the risk can be reduced by installing a range hood that projects horizontally a minimum of 5 inches beyond the bottom of the cabinets.

WARNING

- NEVER use this appliance as a space heater to heat or warm the room. Doing so may result in carbon monoxide poisoning.
- Gas leaks may occur in the system and result in a serious hazard. Gas leaks may not be detected by smell alone. Gas suppliers recommend you purchase and install a UL/CSA approved gas detector. Install and use in accordance with the gas detector manufacturer's instructions.
- To prevent staining or discoloration, clean appliance after each use.

CAUTION

- Wear gloves when cleaning the rangetop to avoid injury or burns.

FLAMMABLE MATERIALS

WARNING

Be certain that all packing materials are removed from the appliance before operating. Keep plastic, clothes, paper, and other flammable materials away from parts of the appliance that may become hot.

- Do not store or use flammable material near or on the cooktop. Flammable materials include paper, plastic, pot holders, linens, wall coverings, curtains, and gasoline or other flammable vapors and liquids such as grease or cooking oil. These materials can be ignited when the cooktop is in use.
- **Wear proper apparel.** Do not wear loose-fitting or hanging garments, which may ignite if they contact hot surfaces, and cause severe burns.
- If cabinet storage is provided directly above cooking surface, use it to store items that are not frequently used and can be safely stored in an area subjected to heat. Temperatures may be unsafe for volatile items such as flammable liquids, cleaners or aerosol sprays.

ELECTRICAL SAFETY

CAUTION

- Be certain that all packing materials are removed from the appliance before operating. Keep plastic, clothes, paper, and other flammable materials away from parts of the appliance that may become hot.
 - Risk of Electric Shock. If the cord or plug becomes damaged, disconnect the appliance from the power supply and replace only with a cord or plug of the same type.
- Always disconnect power from the appliance before servicing.
 - Do not allow aluminum foil to contact heating elements.

DEEP FAT FRYER

- Use extreme caution when moving or disposing of hot grease.
- Always heat fat slowly, and watch as it heats.
- If frying combinations of oils and fats, stir them together before heating.
- Use a deep fat thermometer, if possible, to prevent overheating fat beyond the smoking point.
- Use the least possible amount of fat for effective shallow or deep-fat frying. Filling the pan with too much fat can cause spillovers when food is added.

CHILD SAFETY

- Do not leave small children unattended near the rangetop.

WARNING

Do not leave children alone or unsupervised near the appliance when it is in use or is still hot. Children should never be allowed to sit or stand on any part of the appliance as they could be injured or burned.

CAUTION

Do not store items of interest to children in cabinets above a range or on the back guard of the appliance – children climbing on the appliance to reach items could be seriously injured.

- Let hot utensils cool in a safe place, out of reach of small children.
- Children should not be allowed to play with controls or other parts of the appliance.

SURFACE BURNERS

WARNING

- Even if the top burner flame goes out, gas is still flowing to the burner until the knob is turned to the **Off** position. If you smell gas, immediately open a window and ventilate the area for five minutes prior to using the burner. Do not leave the burners on unattended.
- **Use proper pan size.** Do not use pans that are unstable or that can be easily tipped. Select cookware with flat bottoms large enough to cover burners. To avoid spillovers, make sure the cookware is large enough to contain the food properly. This will both save cleaning time and prevent hazardous accumulations of food, since heavy spattering or spillovers left on the cooktop can ignite. Pans should not be larger than 11 in.(280 mm) in diameter. Use of oversized pans may discolor the stainless areas around the cooktop perimeter. Clean discolored areas with stainless steel appliance cleaner. Use pans with handles that can be easily grasped and remain cool.

CAUTION

- Be sure that all surface controls are set in the **Off** position prior to supplying gas to the rangetop.
- Never leave the surface burners unattended at high flame settings. Boilovers may cause smoke and greasy spillovers that may ignite.
- Always turn the knobs to the **Lite** position when igniting the top burners and make sure the burners have ignited.
- Control the top burner flame size so it does not extend beyond the edge of the cookware. Excessive flame is hazardous.
- Only use dry pot holders- moist or damp pot holders on hot surfaces may result in burns from steam. Do not let pot holders come near open flames when lifting cookware. Do not use towels or other bulky cloth items. Use a pot holder.
- If using glass cookware, make sure the cookware is designed for range-top cooking.
- To prevent burns from ignition of flammable materials and spillage, turn cookware handles toward the side or back of the cooktop without extending them over adjacent burners.
- Never leave any items on the cooktop. The hot air from the vent may ignite flammable items and will increase pressure in closed containers, which may cause them to burst.

 **CAUTION**

- Carefully watch foods being fried at a high flame setting.
- Always heat fat slowly, and watch as it heats.
- If frying combinations of oils and fats, stir together before heating.
- Use a deep fat thermometer if possible to prevent fat from heating beyond the smoking point.
- Use the least possible amount of fat for effective shallow or deep fat frying. Filling the pan with too much fat can cause spillovers when food is added.
- Do not cook foods directly on an open flame on the cooktop.
- Foods for frying should be as dry as possible. Frost or moisture on foods can cause hot fat to bubble up and spill over the sides of the pan.
- Never try to move a pan of hot fat, especially a deep fryer. Wait until the fat is cool.
- Do not place plastic items on the cooktop units— they may melt if left too close to the vent.
- Keep all plastics away from the surface burners.
- To prevent burns, always be sure that the controls for all burners are in the **Off** position and all grates are cool before attempting to remove them.
- If you smell gas, turn off the gas to the appliance and call a qualified service technician. Never use an open flame to locate a leak.
- Always turn the knobs to the **Off** position before removing cookware.
- Do not lift the cooktop. Lifting the cooktop can cause damage and improper operation of the appliance.
- If the appliance is located near a window, do not hang long curtains that could blow over the surface burners and catch on fire.
- Use care when cleaning the cooktop. The pointed metal ends on the electrodes could cause injury.
- Stand away from the appliance while frying.
- Keep an eye on foods being fried at high or medium high heat settings.

GLASS-CERAMIC COOKING SURFACE

- Surface units may be hot even though they are dark in color. Areas near surface units may become hot enough to cause burns. During and after use, **DO NOT TOUCH SURFACE UNITS OR AREAS NEAR UNITS** or let clothing or other flammable materials contact surface units or areas near units until they have had sufficient time to cool. This includes the induction plate.
- **Do not cook on a broken induction plate.** If the induction plate is broken, cleaning solutions and spillovers may penetrate the broken induction plate and create a risk of electric shock. Switch off the appliance to avoid the possibility of electric shock and contact a qualified technician immediately.
- Do not use the glass induction plate surface as a cutting board.
- Do not place or store items that can melt or catch fire on the glass induction plate, even when it is not being used.
- Select pans that have flat bottoms large enough to cover the heating elements.
- Never cook directly on the glass. Always use cookware.
- Always turn the surface units off before removing cookware. Do not rely on the pan sensor.



WARNING

Do not leave fats or oils to heat unattended on the cooktop. Spillovers can result in a fire.

- The induction plate is not intended to be operated by means of an external timer or separate remote-control system.
- **Turn cookware handles inward so they don't extend over adjacent surface units.** This reduces the risk of burns, ignition of flammable materials, and spillage due to unintentional contact with the cookware.
- Immediately clean spills on the cooking area to prevent a tough cleaning chore later.
- Some cleaners can produce dangerous fumes if applied to a hot surface.
- Do not place metal objects such as knives, forks, spoons, and lids on the induction plate surface, because they can get hot.
- Always place the pan in the center of the surface unit you are cooking on. **Never leave surface units unattended at high heat settings.** Proper contact of cookware to burner also will improve efficiency. Boilovers cause smoking and greasy spills that may catch on fire.
- **Clean induction plate with caution.** Do not use sponges or cloths to wipe spills on a hot cooking area. Use a proper metal scraper. If a wet sponge or cloth is used to wipe spills on a hot cooking area, it can cause steam burns. Some cleaners can produce noxious fumes if applied to a hot surface.
- Do not turn surface units on before placing cookware.
- Do not store heavy items above the induction plate surface that could fall and damage it.
- Do not place aluminum foil or plastic items such as salt and pepper shakers, spoon holders, or plastic wrappings or any other material on the rangetop when it is in use.
- Do not use a steel-wool pad or scrub pad or abrasive cleaning pads. They can scratch the surface.

USING SOUS VIDE



CAUTION

- Use only food grade plastic bags or bags made from materials recommended by the manufacturer for use in cooking.
- Allow sous vide to cool before cleaning or draining the water bath.
- Make sure the water level in the sous vide pan remains between the minimum and maximum fill lines both before and after adding the food pouches.
- Do not operate the sous vide module if the water level is not between these lines. Doing so may result in electric shock or fire.
- Do not touch the water in the sous vide module until it has cooled. Use tongs to take out pouches in the water bath. Failure to follow this precaution can result in burns.
- Allow the sous vide module to cool before touching any surfaces. Use an oven mitt while operating the sous vide to avoid burns or other injury.
- Don't leave water in water bath after use. Allow the module to cool before draining the bath and drying it with a clean cloth.
- Do not place or store objects on the glass cover of the sous vide. Doing so can damage the cover.
- Only use pouches which are designed for vacuum sealing.
- Vacuum sealing does not prevent food from spoiling. Refrigerate perishable food.
- Sharp edges on food, such as bones or dried noodles, can puncture pouches during vacuum sealing. Wrap sharp edges with paper towels or softer food items.

FOOD PACKAGING AND STORAGE SAFETY INFORMATION

- Always wash your hands carefully with soap and water before and after handling food.
- Keep all work surfaces and utensils clean and disinfected before and after packaging foods.
- Temperature, moisture, acidity, and salt or sugar content of foods can influence the growth of potentially harmful microorganisms in food.
- For safety, vacuum-sealed fresh (perishable) foods should be kept in the "safe zones": cooled to 40°F/4°C or below or heated to 130°F/55°C or above.
- Vacuum-sealed pouches of cooked foods can be quick chilled by submerging them in ice water (half ice/half water) for 30 to 60 minutes and then refrigerated for up to 48 hours or frozen for up to a year.

ENERGY SAVING TIPS

- Match the size of the cookware to the amount of food being cooked to save energy when heating. Heating ½ quart of water requires more energy in a 3-quart pot than in a 1-quart pot.
- Match the size of the cooktop burner or element to the size of the cookware in use. Using a large element for a small pan wastes heating energy, and the exposed surface of the element is a burn or fire hazard.

SAFETY DURING USE

- Accessible parts may become hot when the grill is in use.
- When disposing of the rangetop, cut off the power cord.

SAFETY WHEN CLEANING

- For your safety, do not use high-pressure water cleaners or steam jet cleaners to clean the product.

COOK MEAT AND POULTRY THOROUGHLY

- To protect against food-borne illnesses, cook meat and poultry thoroughly. The USDA has indicated the following as safe minimum internal temperatures for consumption:
 - Ground meats: 160 °F
 - All poultry: 165 °F
 - Beef, veal, pork, or lamb: 145 °F
 - Fish/seafood: 145 °F

PRODUCT OVERVIEW

Parts

Model: SKSRT480SIS

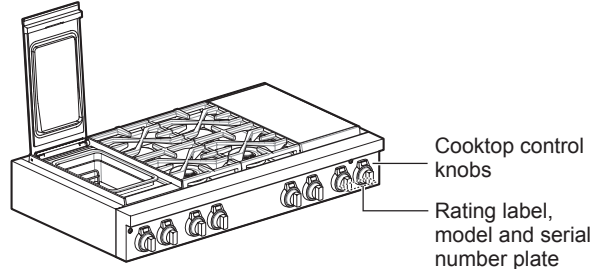
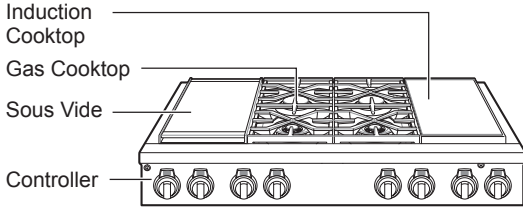

Model: SKSRT360SIS

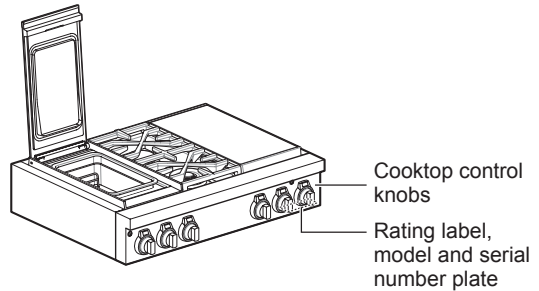
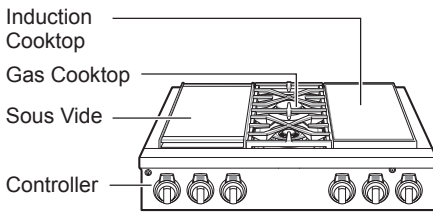

Accessories

Included Accessories



Owner's manual
(1 ea)

LP Nozzle Conversion Kit

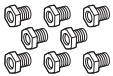

Cooktop nozzles
- SKSRT480SIS (8 ea)
- SKSRT360SIS (4 ea)

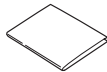

Installation guide (1 ea)

Sous Vide Module Accessories

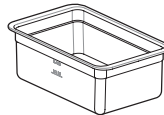

Bath (1 ea)



Sous Vide Rack (1 ea)

NOTE

- If accessories are missing, call 1-855-790-6655 or visit our website at: www.sksappliances.com
- For your safety and for extended product life, only use authorized components.
- The manufacturer is not responsible for product malfunction or accidents caused by the use of separately purchased, unauthorized components or parts.
- The images in this guide may be different from the actual components and accessories, which are subject to change by the manufacturer without prior notice for product improvement purposes.

INSTALLATION

Product Specifications

The appearance and specifications listed in this manual may vary due to constant product improvements.

Rangetop Models	SKSRT480SIS, SKSRT360SIS
Description	SKSRT480SIS : 48" Duel Fuel Rangetop SKSRT360SIS : 36" Duel Fuel Rangetop
Electrical requirements	SKSRT480SIS : 4.7 kW 120/240 VAC 19 A, 4.3 kW 120/208 VAC 19 A SKSRT360SIS : 4.7 kW 120/240 VAC 19 A, 4.3 kW 120/208 VAC 19 A
Power Cable	5.2 ft. (1.6m) Conduit
Gas / Electric Location	Left Rear
Rangetop Dimensions	SKSRT480SIS : 47 ⁷ / ₈ " (1216 mm) (W) x 8 ¹⁵ / ₁₆ " (228 mm) (H) x 26 ³ / ₄ " (679 mm) (D) SKSRT360SIS : 35 ⁷ / ₈ " (911 mm) (W) x 8 ¹⁵ / ₁₆ " (228 mm) (H) x 26 ³ / ₄ " (679 mm) (D)
Countertop Cutout Dimensions	SKSRT480SIS : 48" (1219.2 mm) (W) x 7 ²⁵ / ₃₂ " (198 mm) (H) x min. 24" (610 mm), max. 25"(635 mm) (D) SKSRT360SIS : 36" (914.4 mm) (W) x 7 ²⁵ / ₃₂ " (198 mm) (H) x min. 24" (610 mm), max. 25"(635 mm) (D)
Height to Cooking Surface	36" (91.4 cm)

Before Installing the Rangetop



WARNING

- **The information in this manual should be followed exactly.** Failure to do so may result in fire, electrical shock, property damage, personal injury, or death.
- **Wear gloves during the installation procedure.** Failure to do so can result in bodily injury.
- Make sure no parts came loose during shipping.

NOTE

- Important - Save for the local electrical inspector's use.

In the Commonwealth of Massachusetts

- This product must be installed by a licensed plumber or gas fitter.
- When using ball type gas shut-off valves, they must be the T-handle type.
- When using a flexible gas connector, it must not exceed 3 feet in length.

NOTE

- Observe all governing codes and ordinances.
- Have the installer show you the location of the circuit breaker or fuse. Mark it for easy reference.
- As when using any appliance generating heat, follow basic safety precautions.
- Be sure your appliance is installed and grounded properly by a qualified installer or service technician according to the installation instructions.
- Any adjustment and service should be performed only by qualified gas range installers or service technicians.

Preparing for Installation

Tools Needed



Phillips screwdriver



Flat-blade screwdriver

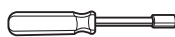

1/4" Nut driver

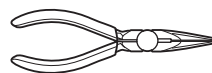

Pliers



Level



Open-end or adjustable wrench

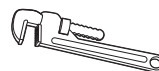
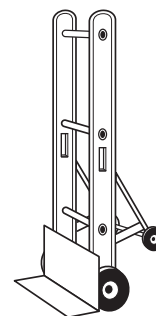

Safety glasses

Pipe wrench (2)
(one for support)

Dolly

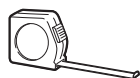

Tape measure



Gloves

Materials You May Need

- Gas line shut-off valve
- Pipe joint sealant that resists action of natural and LP gases
- Flexible metal appliance connector ($3/4$ " or $1/2$ " NPT x $1/2$ " I.D.)
Never use an old connector when installing a new rangetop.
- Flare union adapter for connection to gas supply line ($3/4$ " or $1/2$ " NPT x $1/2$ " I.D.)
- Flare union adapter for connection to pressure regulator on rangetop ($1/2$ " NPT x $1/2$ " I.D.)
- Liquid leak detector or soapy water
- Junction box
- Wire nuts
- $3/4$ " conduit connector

Ventilation Requirements

It is recommended that these rangetops be installed in conjunction with a suitable overhead vent hood.

Due to the high heat capacity of this unit, particular attention should be paid to the hood and ductwork installation to assure it meets local building codes.

WARNING

Do not install this product with an air curtain hood or other range hood that operates by blowing air down on the cooktop. This airflow may interfere with operation of the gas burners resulting in fire or explosion hazard.

See below for the minimum clearance from the cooking surface to any horizontal surface above the rangetop. Failure to observe this clearance may result in a fire hazard.

- Installations without a hood require a 36" minimum distance to any overhead combustible surface.

Proper Location

- If the unit is to be placed adjacent to cabinets, the clearances shown in "Install Clearances" are required. The same clearances apply to island installations, except for overhead cabinets, which must have a space wide enough to accept the flared island hood.
- The rangetop should not be recessed into the cabinets beyond the edge of the front face. (See "Product Dimensions and Clearances".)
- The maximum depth of overhead cabinets installed on either side of the hood is 13" (330 mm). Wall cabinets must be 18" (457 mm) above the countertop.
- There is a 36" (914 mm) minimum clearance required between the top of the cooking surface and the bottom of an unprotected cabinet. A 30" (762 mm) clearance can be used when the bottom of the wood or metal cabinet is protected by not less than 1/4" (6.4 mm) of a flame retardant material covered with not less than no. 28 MSG sheet steel, 0.015" (0.38 mm) thick stainless steel, 0.024" (0.61 mm) aluminum, or 0.02" (0.51 mm) thick copper.
- Non-combustible surfaces are defined in the National Fuel Gas Code (ANSI Z223.1, curr. ed.). Clearances from non-combustible materials are not part of the ANSI Z21.1 scope and are not certified by CSA. Clearances of less than 36 inches (914.4 mm) must be approved by local codes and/or by the local authority having jurisdiction.

CAUTION

- **The rangetop must be level to operate properly.**
- **Avoid placing cabinets above the rangetop.** To minimize the hazard caused by reaching over the open flames of operating burners, install a ventilation hood over the rangetop that projects forward at least five inches beyond the front of the cabinets.
- **Do not locate your rangetop where it may be subject to strong drafts.** The left and right side panels are 5 mm higher than the base of the rangetop. Make sure that the sides of the rangetop that supply fresh air for ventilation are not blocked.

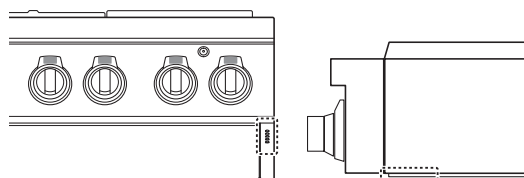

- **This rangetop is for indoor, household use only.**
- **If the rangetop is located near a window, do not hang long curtains or paper blinds on that window.**
- **Make sure that the wall coverings, countertop and cabinets around the rangetop can withstand the heat (up to 194 °F) generated by the appliance.** Discoloration, delamination or melting may occur. This appliance has been designed to comply with the maximum allowable wood cabinet temperature of 194 °F.

Install Clearances

The location of gas burners and cooktop modules vary depending on the rangetop model.

Important Installation Information

Rangetops use a single phase, four-wire cable, 120/240 volt, 60 hertz, AC-only electrical supply with ground.

Model: SKSRT480SIS

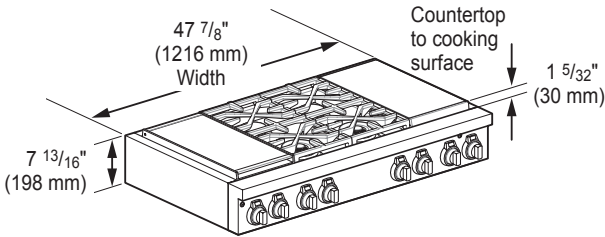

Model: SKSRT360SIS

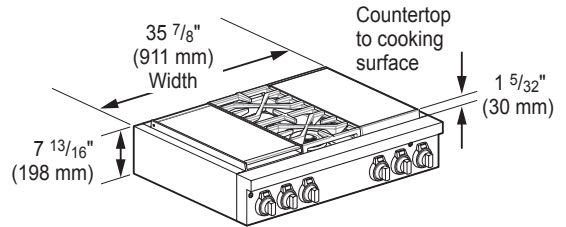

Universal Utility Locations

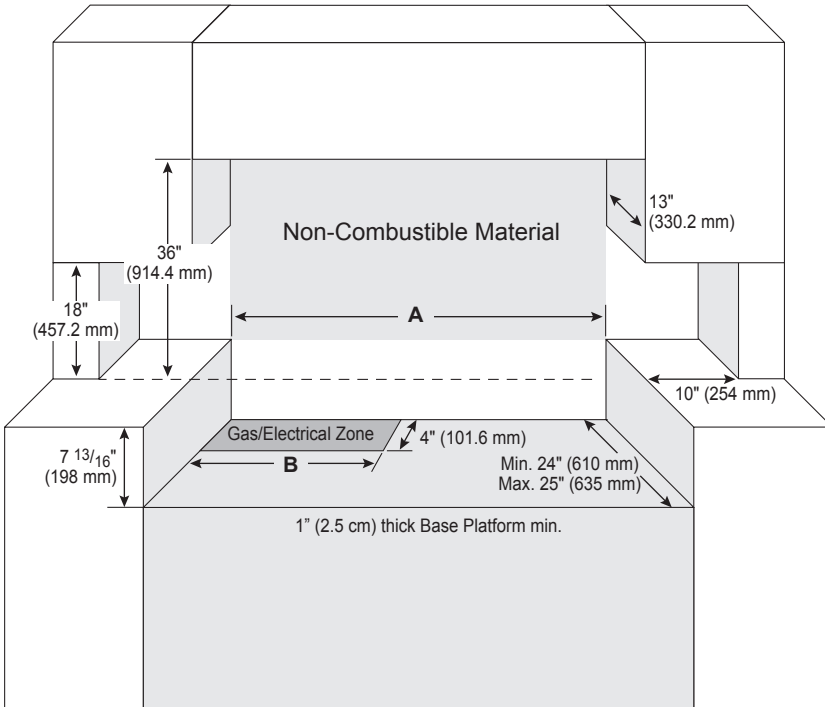

Model	SKSRT480SIS	SKSRT360SIS
A	48" (1219.2 mm)	36" (914.4 mm)
B	16" (406.4 mm)	16" (406.4 mm)

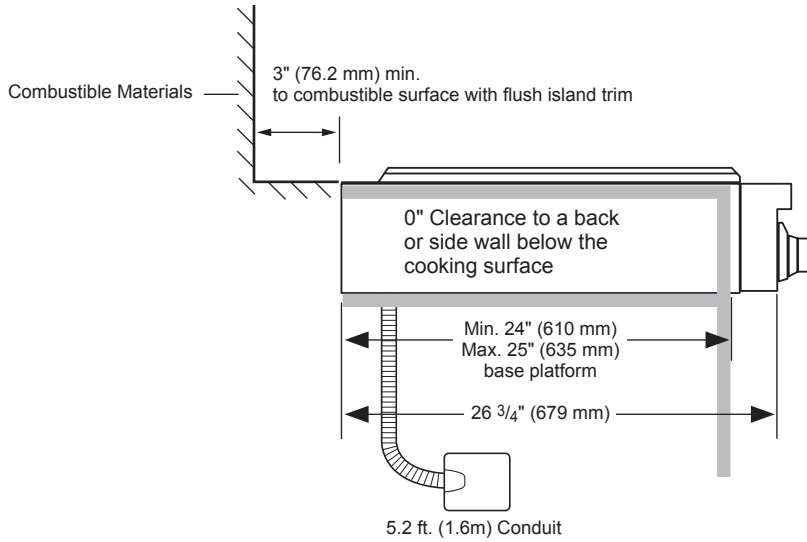

Product Dimensions and Clearances

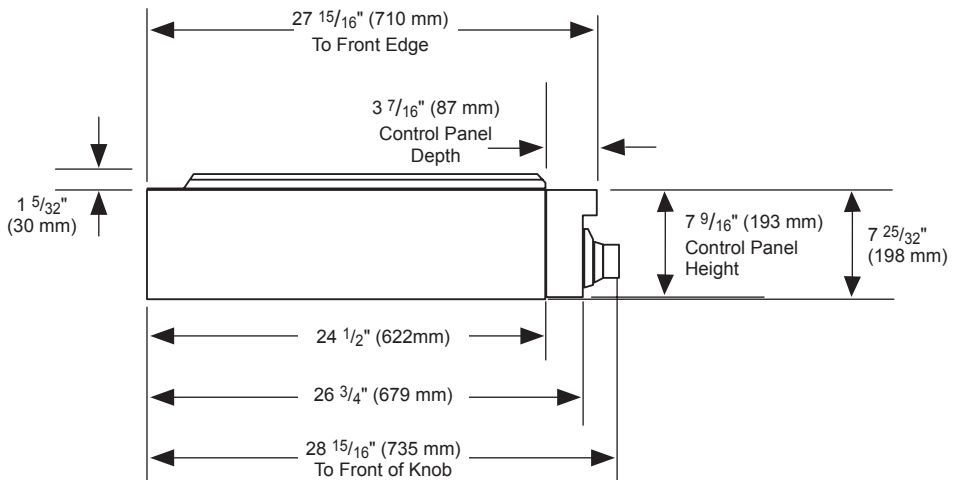

Ventilation

- **Do not locate your rangetop where it may be subject to strong drafts.** The left and right side panels are 5 mm higher than the base of the rangetop. Make sure that the sides of the rangetop that supply fresh air for ventilation are not blocked.

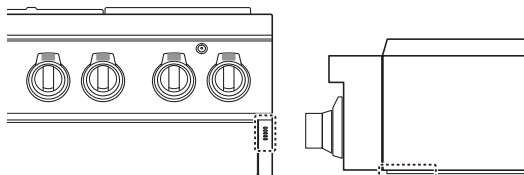

Gas Supply

The rangetop is designed to operate at a pressure of 5" of water column on natural gas or 10" of water column on LP.

Make sure that you are supplying the rangetop with the type of gas for which it is configured.

This rangetop is convertible for use with natural or LP gas. When using this rangetop with LP gas, conversion must be made by a qualified LP installer before attempting to operate the rangetop.

For proper operation, the pressure of natural gas supplied to the regulator must be between 6" and 10.5" of water column.

For LP gas, the pressure supplied to the regulator must be between 11" and 13" of water column. When checking for correct operation of the regulator, the inlet pressure must be at least 1" more than the operating (manifold) pressure as given above.

The pressure regulator located at the inlet of the rangetop must remain in the supply line regardless of which type of gas is being used.

A flexible metal appliance connector used to connect the rangetop to the gas supply line should have an I.D. of $\frac{5}{8}$ " and a maximum length of 5 feet. In Canada, flexible connectors must be single wall metal connectors less than 6 feet in length.

Installing the Rangetop

Unpacking the Rangetop



CAUTION

- **Excessive Weight Hazard: You should use 2 or more people to move and install the appliance.** Failure to do so can result in back or other injury.

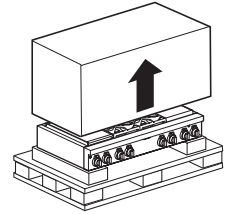
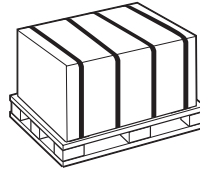

- 1 Cut the packing straps. Lift the carton straight up. Remove packing material, tape and any temporary labels from the appliance before using. Leave the adhesive-backed foam layer over the brushed-metal surface, to protect the finish from scratches. Do not remove any warning-type labels, the model and serial number label, or the Tech Sheet that is located on the back of the rangetop.
- 2 The grates, burner heads, burner caps, and trays must be removed to facilitate handling.

Moving the Rangetop

CAUTION

- Do not lift the rangetop by its control panel.
- Remove rings, watches, and any other loose items that may damage or become entangled with the unit.
- Hidden surfaces may have sharp edges. Wear gloves and use caution when reaching behind or under the appliance.
- Do not use a hand truck or appliance dolly on the front of the unit. Handle from the back only when using dolly.
- Due to the weight, it is strongly recommended that a furniture dolly with soft wheels or an air lift be used to move this product. The weight must be supported uniformly across the bottom.

- 1 Carefully lift the rangetop from the pallet and insert the dolly at the back of the rangetop. Use additional help as required to remove the product from the pallet. To prevent damage to the sides of the rangetop, pad the corners beneath the straps on the dolly.

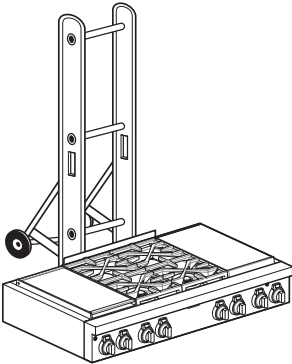

- 2 Transport the rangetop on the furniture dolly close to its final location, tip the rangetop back to level, and carefully remove the dolly.

Installing the Power Cord Bracket

- 1 The rangetop ships with the power cord bracket facing backward.
- 2 During installation, remove the 2 screws holding the bracket in place and reverse the bracket so that the U-shaped opening is on the bottom.

Power Cord Bracket

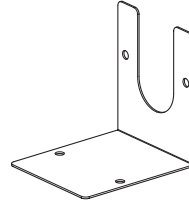

As shipped

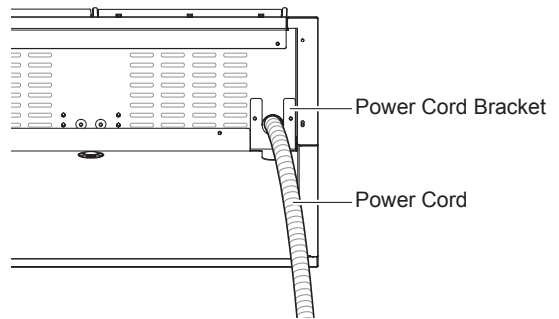

Reassembled for installation

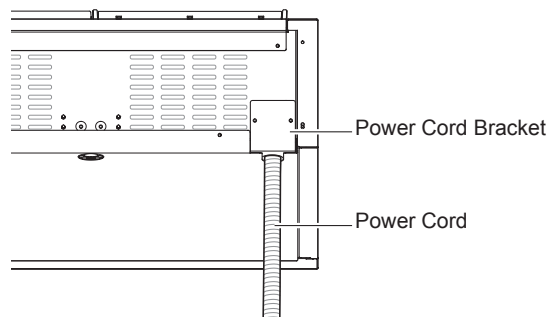

Connecting the Rangetop to Gas

This appliance must be installed in accordance with local codes or, in the absence of local codes, with the National Fuel Gas Code, ANSI Z223.1/NFPA 54 or, in Canada, the Natural Gas and Propane Installation Code, CSA B149.1.

Shut off the appliance gas supply valve before removing the old appliance and leave it off until the new hook-up has been completed.

Because hard piping restricts movement of the appliance, a CSA International-certified flexible metal appliance connector should be used unless local codes require a hard-piped connection.

A manual valve must be installed in an accessible location in the gas piping external to the appliance for the purpose of turning on or shutting off gas to the appliance.

Never reuse an old connector when installing a new appliance.

To protect against gas leaks, use a qualified pipe joint sealant on all external threads.

- 1 An inlet pipe is set on the left rear of the appliance. Connect a gas hose that has a 1/2" NPT internal thread to the inlet pipe using a wrench.
- 2 Apply sealing compound or Teflon tape at the connection.
- 3 When all connections have been made, turn all appliance controls to the **Off** position and turn on the main gas supply valve. Gas leaks may occur in your system and create a hazard. Gas leaks may not be detected by smell alone.

Check all gas connection joints and fittings for leaks with a non-corrosive leak detection fluid. Wipe off fluid after checking.

Gas suppliers recommend that you purchase and install a UL/CSA approved gas detector. Install and use in accordance with the installation instructions.

WARNING

- Do not use a flame to check for gas leaks.
- The appliance and its individual shut-off valve must be disconnected from the gas supply piping system during any pressure testing of that system at test pressures in excess of 1/2 psi (3.5 kPa).
- The appliance must be isolated from the gas supply piping system by closing its individual manual shut-off valve during any pressure testing of the gas supply piping system at test pressures equal to or less than 1/2 psi (3.5 kPa).

Flexible Connector Hookup

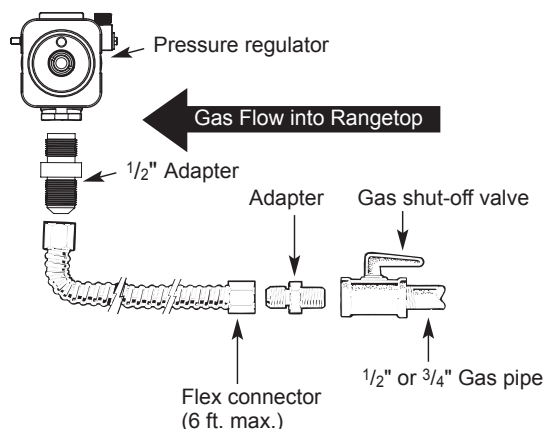

Installer: Inform the consumer of the location of the gas shutoff valve.

Pressure Regulator Location

The pressure regulator is located at the rear of the rangetop, on the left side.

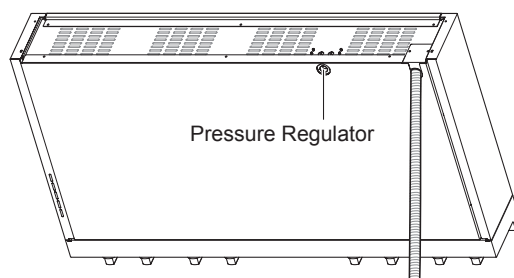

NOTE

This rangetop leaves the factory set for use with natural gas. When converting to LP gas, read the LP (propane) gas conversion instructions located in the conversion kit accessory bag.

Electrical Connections

Electrical Connection Requirements

Follow the electrical connection requirements below. Ensure that dedicated circuit protection is prepared as recommended and that the rangetop is grounded properly.

IMPORTANT NOTE

Be sure that the rangetop is installed and grounded properly by a qualified installer or service technician.

- If an external electrical source is utilized, the appliance, when installed, must be electrically grounded in accordance with local codes or, in the absence of local codes, with the National Electrical Code, ANSI/NFPA 70 or the Canadian Electric Code, CSA C22.1-02.
- This rangetop must be supplied with the proper voltage and frequency, and connected to an individual, properly grounded branch circuit, protected by a circuit breaker or fuse. For the circuit breaker or fuse required by this model, see the rating plate to find the wattage consumption, and refer to below to get the circuit breaker or fuse amperage.
- This rangetop can consume up to 4,700 W at 240 VAC. A 30 Amp circuit breaker with wire gauge #10 AWG must be used.
- A UL-listed conduit connector must be provided at the junction box.



WARNING

- **The electrical power must be shut off while the electrical connections are being made.**
 - Failure to do so can result in severe personal injury, death or electrical shock.
- **New branch-circuit installations (1996 NEC), mobile homes, recreational vehicles, or installations where local codes prohibit grounding through the neutral conductor require 4-wire branch-circuit connection.**
- **Improper connection of aluminum house wiring to copper leads can result in an electrical hazard or fire. Use only connectors designed for joining copper to aluminum and follow the manufacturer's recommended procedure closely.**
- **Electrical ground is required on this appliance.**
- **Make sure that the power cord is not pinched by heavy objects.** Failure to do so can result in serious burns or electrical shock.
- Do not put a fuse in a neutral or ground circuit.
- Do not connect the ground wire to plastic plumbing lines, gas lines, or hot water pipes.

Electrical Connection

Prepare the electrical connection as follows:

- 1 Turn off the circuit breaker or remove fuses to the rangetop branch circuit.
- 2 With the rangetop positioned directly in front of the cabinet opening, connect the flexible conduit to the electrical junction box. Position the conduit so that it will lie on top of the rangetop in a natural loop when the rangetop is installed.
- 3 If local codes permit connection of the frame grounding conductor to the neutral (white) wire, follow the instructions for a 3-wire circuit connection.
- 4 If used in mobile homes, new construction, or a recreational vehicle, or if local codes do not permit connection of the frame grounding conductor to the neutral (white) wire, follow the instructions for a 4-wire circuit connection.

IMPORTANT NOTE

- The rangetop must be hard wired (direct wired) into an approved junction box. A plug and receptacle is not permitted on these products.
- DO NOT shorten the flexible conduit. The conduit connector must be securely attached to the junction box, and the flexible conduit must be securely attached to the conduit connector. If the flexible conduit will not fit in the connector, do not install the rangetop until a connector of the proper size is obtained.
- You will need to purchase an appropriate conduit connector to complete the connection of the conduit to the junction box.

3-Wire Circuit Connection

To connect to a three-wire circuit, follow these steps:

- 1 Connect the green ground wire and the white neutral wire on the rangetop to the white or gray neutral wire on the branch circuit, using a wire nut.
- 2 Following local codes, connect the red wire on the rangetop to the red (L2) wire on the branch circuit using a wire nut.
- 3 Following local codes, connect the black wire on the rangetop to the black (L1) wire on the branch circuit, using a wire nut. If the house wiring uses aluminum conductors, see the WARNING on the previous page.
- 4 Install the junction box cover.

Junction Box

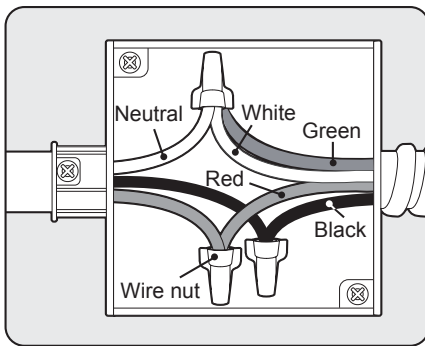

4-Wire Circuit Connection

To connect to a four-wire circuit, follow these steps:

- 1 Separate the ground and white wires on the rangetop if necessary.
- 2 Following local codes, connect the green ground wire on the rangetop to the green ground wire on the branch circuit, using a wire nut. If the house wiring uses aluminum conductors, see the WARNING on the previous page.
- 3 Following local codes, connect the white wire on the rangetop to the white or gray neutral wire on the branch circuit, using a wire nut.
- 4 Following local codes, connect the red wire on the rangetop to the red (L2) wire on the branch circuit, using a wire nut.
- 5 Following local codes, connect the black wire on the rangetop to the black (L1) wire on the branch circuit, using a wire nut. If the house wiring uses aluminum conductors, see the WARNING on the previous page.
- 6 Install the junction box cover.

Junction Box

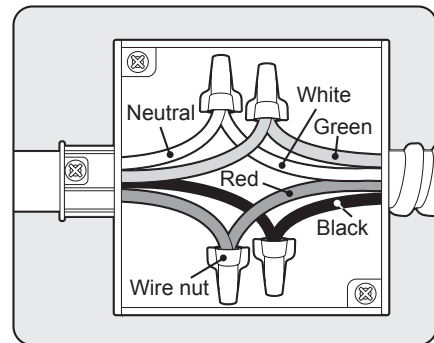

Checking Ignition of the Surface Burners

Electric Ignition

Select a surface burner knob and simultaneously push in and turn to the **Lite** position. You will hear a clicking sound indicating proper operation of the spark module.

Once the air has been purged from the supply lines the burner should ignite within 4 seconds. After the burner ignites, rotate the knob out of the **Lite** position. Try each burner in succession until all burners have been checked.

Quality of Flames

The combustion quality of the burner flames needs to be confirmed visually.



A **Yellow flames** - Call for service.



B **Yellow tips on outer cones** - This is normal for LP gas.



C **Soft blue flames** - This is normal for natural gas.

NOTE

- With LP gas, some yellow tipping on outer cones is normal.

Adjusting the Surface Burner to the Low Flame (Simmer) Setting

- The continuous simmer setting needs to be adjusted on all burners.
- The Extra Low Simmer settings on the small (15K BTU) burners are adjusted automatically as the flame cycles off and on.

- 1 Remove the knob on the burner being adjusted.
- 2 Unscrew the 2 screws to remove the locking plate.

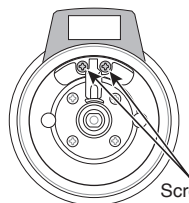

Screws for locking plate (2ea)

- 3 Reassemble the burner knob.
- 4 Light all surface burners.
- 5 Turn the knob on the burner being adjusted to the Simmer or S4 position, and remove the knob.
- 6 Insert a small, flat-blade screwdriver into the valve shaft opening on the left, and turn the adjustment screw until the flame reaches the desired size.

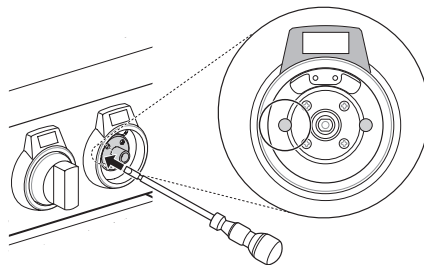

NOTE

- Hold the valve shaft with one hand while turning the screw to adjust with the other.
- For the center rear burner of model SKSRT360SIS, insert the screwdriver into the valve shaft opening on the right.

- 7 Reassemble the locking plate and burner knob.
- 8 Test the flame stability.

Test 1: Quickly turn the knob from the highest setting to the Simmer or S4 position. If the flame goes out, increase the flame size and test again.
- 9 Repeat steps 1-8 for each gas surface burner.

OPERATION

Control Panel Overview

The position of the control knobs and buttons varies by model.

Model: SKSRT480SIS

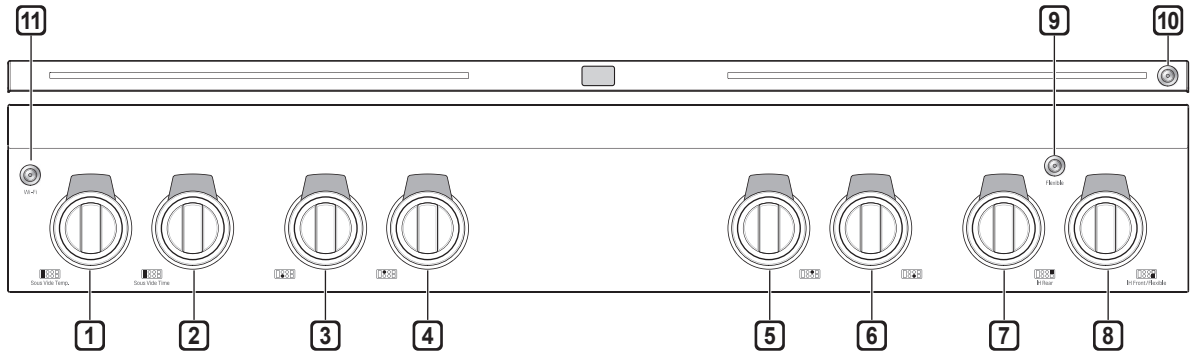

- 1** Sous Vide Temperature Control
- 2** Sous Vide Cooking Time Control
- 3** Left Front Burner Control
- 4** Left Rear Burner Control
- 5** Right Rear Burner Control
- 6** Right Front Burner Control
- 7** Rear Induction Element Control
- 8** Front Induction Element Control
- 9** Flexible On/Off
Used to heat large containers on the induction surface.
- 10** Night Light On/Off
- 11** Wi-Fi On/Off

Model: SKSRT360SIS

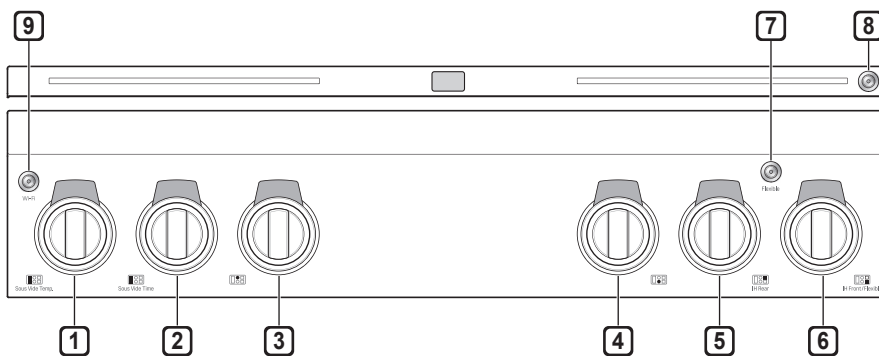

- 1** Sous Vide Temperature Control
- 2** Sous Vide Cooking Time Control
- 3** Center Rear Burner Control
- 4** Center Front Burner Control
- 5** Rear Induction Element Control
- 6** Front Induction Element Control
- 7** Flexible On/Off
Used to heat large containers on the induction surface.
- 8** Night Light On/Off
- 9** Wi-Fi On/Off

Changing Settings

Sabbath Mode

Sabbath mode is used on the Jewish Sabbath and Holidays.

While the rangetop is in Sabbath mode, the timer and alarm functions are disabled.

The cooktop modules are disabled in Sabbath mode, except for the gas burners.

The "Sb" displayed will not change when operating the gas burners.

Setting Sabbath Mode

- 1 Press and hold the Wi-Fi and Night Light buttons at the same time for 3 seconds.
- 2 A short beep sounds, and all knob rings display "Sb".
- 3 The Sabbath mode does not turn off automatically. To manually stop Sabbath mode, press and hold the Wi-Fi and Night Light buttons at the same time for 3 seconds.

NOTE

- The extra low simmer function on the small (15K BTU) burner is controlled electronically and automatically turns off and on. Do not use the simmer function on the small burner while in Sabbath mode.
- Gas burners in use when the power goes out will continue to operate in Sabbath mode.

Wi-Fi

Connect the appliance to a home Wi-Fi network to use Remote Start and other smart functions. See the Smart Functions section for more details.

Setting Up Wi-Fi

- 1 Press and hold the Wi-Fi button for 3 seconds.
- 2 The Wi-Fi LED blinks to indicate it is ready for setup.
- 3 Connect the appliance to the Wi-Fi network using the smartphone app.
- 4 After Wi-Fi setup is complete, the Wi-Fi LED turns on.
- 5 To disconnect the appliance from the network, delete it from the registered appliances in the app.

Smart Diagnosis™

Smart Diagnosis™ can be run through a smartphone application. See "Smart Diagnosis Function" in the Smart Functions section for detailed instructions.

- The Audible Diagnosis function is not provided.

Using the Cooktop

Cooktop Modules

The size and location of gas burners vary depending on the rangetop model.

The large burners are the primary burners for most cooking. The small burners are used for delicate foods such as sauces or foods that require low heat for a long cooking time.

The sous vide module uses a water bath to cook food which has been vacuum-sealed in pouches.

The induction elements use a magnetic field to quickly and efficiently heat just the cookware, not the cooktop surface.

Cooktop Layouts

Model: SKSRT480SIS

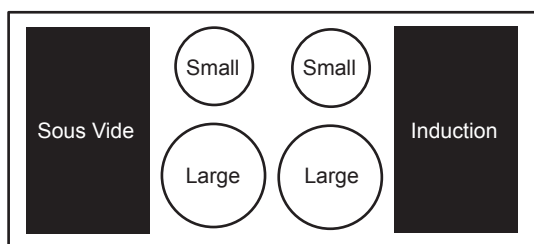

Model: SKSRT360SIS

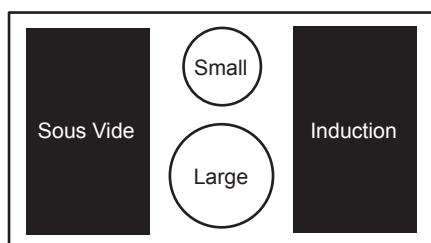

Cooktop Timers

Each cooktop control knob has an LED display at the top which provides information such as heat level, temperature, or time remaining. The gas and induction element control knobs include a timer function. The red LED numbers display temperature levels and the blue LED numbers display the timer countdown.

Setting the Cooktop Timers

A cooktop timer can only be set when the element is in use. After the timer ends, a chime sounds until the element is turned OFF.

- 1 Push in and turn the knob to turn on the element.
- 2 Set a timer by turning the LED ring behind the knob. Turn the LED ring right or left and hold it to increase or decrease the time.
- 3 Release the LED ring when the desired time appears in the knob display.
- 4 The knob display shows the time counting down. A chime sounds when the time ends.
- 5 To cancel a timer, turn the LED ring to the left until 1 appears in the display. Then, turn the LED ring to the left again.

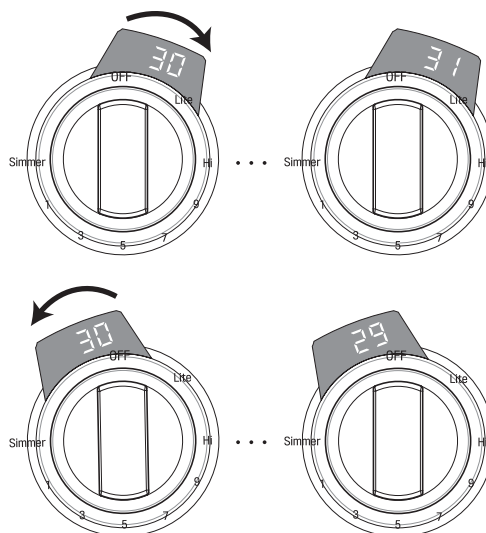

Cooktop	Time Range
Gas Cooktop	1 min. – 12 hr.
Sous Vide Module	1 min. – 48 hr.
Induction Cooktop	1 min. – 12 hr.

The Gas Surface Burners

Before Use

Read all instructions before using.

Make sure that all burners are properly placed.

Burner locations differ depending on the rangetop model.

Burner locations can be found under "Using the Cooktop."

Make sure that all grates are properly placed before using the burners.

CAUTION

Do not operate the burners for an extended period of time without cookware on the grate.

The finish on the grate may chip without cookware to absorb the heat.

Make sure the burners and grates have cooled down before touching them, or placing a pot holder, cleaning cloth, or other materials on them.

Touching grates before they cool down may cause burns.

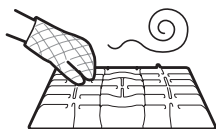

CAUTION

WHAT TO DO IF YOU SMELL GAS

- Open windows.
- Do not try to light any appliance.
- Do not touch any electrical switch.
- Do not use any phone in your building.
- Immediately call your gas supplier from a neighbor's phone. Follow the gas supplier's instructions.
- If you cannot reach your gas supplier, call the fire department.

NOTE

Electric spark igniters from the burners cause a clicking noise. If the flame goes out, the reignition system reignites the burners automatically.

Using the Gas Surface Burners

- 1 Be sure that all of the surface burners and grates are placed in the correct positions.
- 2 Place cookware on the grate.
- 3 Push the control knob and turn to the **Lite** position until the flames have ignited.

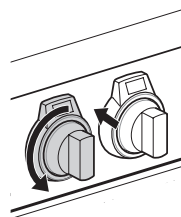

The electric spark ignition system makes a clicking noise.

- 4 Turn the control knob to control the flame size.

Large gas burner

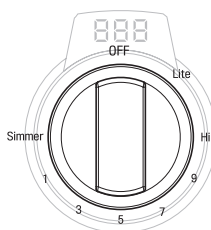

Small gas burner

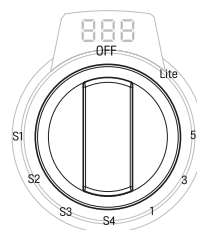

Simmer : S1-S4

CAUTION

Do not attempt to disassemble or clean around any burner while another burner is on. All the burners spark when any burner is turned to **Lite**. An electric shock may result causing you to knock over hot cookware.

NOTE

- It is normal for the flames to turn off and on periodically during Extra Low Simmer (S1, S2 and S3).
- It is normal to occasionally hear the spark igniters operating while using the gas burner. For safety, the spark igniters are activated if the flame is blown in the wind or momentarily disappears.

Setting the Flame Size

Watch the flame, not the knob, as you reduce heat. Match the flame size on a gas burner to the cookware being used for fastest heating.

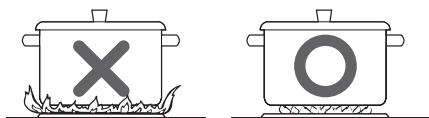

CAUTION

Never let the flames extend up the sides of the cookware.

NOTE

- The flames on the surface burners may burn yellow in the presence of high humidity, such as a rainy day or a nearby humidifier.
- After LP gas conversion, flames can be bigger than normal when you put a pot on the surface burner.
- When turning a surface burner from high heat to simmer quickly, make sure the flames stay lit. See **Checking Ignition of the Surface Burners** section to adjust the burner flames, if necessary.

In Case of Power Failure

If you experience a power outage, you can carefully light the gas surface burners on the rangetop with a match. Gas burners in use when the power goes out will continue to operate normally.

- 1 Hold a lit match to the burner, then push in the control knob.
- 2 Turn the control knob to the 1 position.

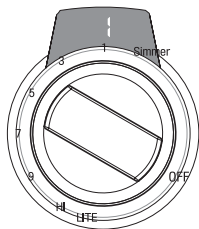

CAUTION

Use extreme caution when lighting burners with a match. Doing so can cause burns and other damage.

Cookware for Gas Burners

Aluminum	Medium-weight cookware is recommended because it heats quickly and evenly. Most foods brown evenly in an aluminum skillet. Use saucepans with tight fitting lids when cooking with minimum amounts of water.
Cast-Iron	If heated slowly, most skillets will give satisfactory results.
Stainless Steel	This metal alone has poor heating properties and is usually combined with copper, aluminum or other metals for improved heat distribution. Combination metal skillets work satisfactorily if they are used with medium heat as the manufacturer recommends.
Enamelware	Under some conditions, the enamel of this cookware may melt. Follow cookware manufacturer's recommendations for cooking methods.
Glass	There are two types of glass cookware. Those for oven use only and those for top-of-range cooking.
Heatproof Glass Ceramic	Can be used for either surface or oven cooking. It conducts heat very slowly and cools very slowly. Check cookware manufacturer's directions to be sure it can be used on gas ranges.

Extra Low Simmer (Small Burners Only)

- Extra Low Simmer is only available on small burners. For the location of your small burners, see the Burner Locations section. The simmer function on the large burners applies heat to food continuously.

Extra Low Simmer controls the heat by turning the flame on and off at preset intervals. This allows foods such as sauces, chocolate and jam to simmer longer without scorching.

- The intervals without flame become longer as you move from S3 to S1.
- The S4 simmer setting keeps the flame lit continuously.

NOTE

- It may look like the burners are turned off during Extra Low Simmer.
- It is normal for the flames to turn off and on periodically during Extra Low Simmer.
- The electric igniters automatically operate periodically to reignite the burners.

Using a Wok

- The large burner grates can be used as wok grates. 14-inch or smaller flat-bottomed woks can be set directly on the grate, if the wok bottom is large enough to sit flat on the grate.

CAUTION

If using a round-bottomed wok, use the included wok grate. Do not use a wok support ring. Placing the ring over the burner or grate may cause the burner to work improperly, resulting in carbon monoxide levels above allowable standards. This can be hazardous to your health.

Using the Wok Grates

The large burner grates can be flipped over to handle a wide variety of round-bottom woks.

- 1 Turn off all burners and allow the grates and cooktop to cool before reversing the grates.
- 2 Flip the large burner grate so the wok grate is facing up.
- 3 Use a 14" round-bottomed wok. Do not use a wok that does not rest securely in the wok grate.

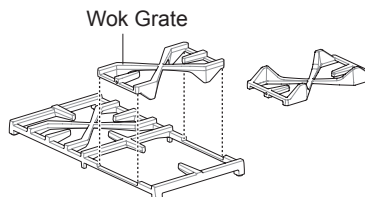

NOTE

- Do not use the wok grate with cookware other than a wok.
- Clean the wok grate with hot, soapy water. Do not use oven cleaners, steel wool, or abrasive cleansers.

CAUTION

- Turn off all burners and allow wok grate, burner grates, and cooktop to cool before reversing or removing wok grate.
- The wok grate retains heat for a long time. Always use an oven mitt when installing or removing the wok grate. Do not store the wok grate on another burner grate.
- Do not use flat-bottomed cookware or incorrectly sized woks with the wok grate. The cookware or wok could tip and cause personal injury.
- Do not use a wok larger than 14" with the wok grate. Doing so could cause burner flames to spread excessively and damage the cooktop.

Using Stove-Top Grills

Do not place stove-top grills on the burner.



CAUTION

Do not use stove top grills on the surface burners. Using a stove top grill on the surface burner will cause incomplete combustion and can result in exposure to carbon monoxide levels above allowable current standards. This can be a health hazard.

Induction Cooktop

The induction cooktop uses an electromagnetic field to directly heat only the pan, not the cooktop. Any cookware that can be strongly magnetized will work for induction cooking.

The induction cooktop has a front element and a rear element. The wattage ratings of each element are below;

Level	Front & Rear	Flexible
Boost	3650 W	3650 W
9	2000 W	3300 W

The LED displays at the front of the induction cooktop and over each control knob indicate the power level of the elements while cooking.

Boost mode can be used for 10 minutes, after which the element is automatically set to level 9.

Benefits of Induction Surface Cooking

Speed and Efficiency

Induction cooking elements heat faster and use less energy. Induction power levels quickly boil liquids and are efficient when simmering.

A Cooler Cooktop

Whether induction cooking elements are turned on or off, they remain cooler than radiant elements. Virtually no heat is wasted because the heat begins with the presence of cookware.

Easy Cleanups

Cooler cooking elements make for easier cleaning. Spills resist sticking or burning so they wipe up easily.

Pan Size Detection

A sensor automatically detects and adapts the induction cooking element to the pan size in use for more consistent, even cooking.

Greater Responsiveness

Induction cooking elements are more responsive than their electric or gas counterparts because only the pan heats. Induction elements heat more easily and are just as responsive when reducing temperatures to a simmer.

Induction Cookware

NOTE

Before using the induction cooking elements, carefully read and follow these cookware recommendations and the instructions in the pan sensing sections.

When purchasing pans for use on the induction cooktop, look for cookware identified by the manufacturer as "induction ready" or "induction capable", or that is marked by the manufacturer as specifically designed for induction cooking.

The base material of the cookware must be magnetic for the cooking elements to activate. Use a magnet to check if the cookware base material is suitable. If the magnet sticks to the bottom of the cookware, the cookware can be used for induction cooking.

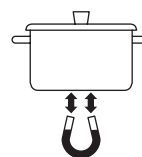

For the best possible surface cooking results, use only high-quality, heavy gauge steel cookware on the induction cooking elements. Follow manufacturer's recommendations when using induction cookware.

Induction Cookware Types

The three most common induction cookware types available are stainless steel, cast iron, and porcelain-enamel-coated metals.

- **Stainless Steel** is generally excellent for induction cooking. It is durable, easy to clean, and resists staining.

NOTE

Not all stainless steel cookware is magnetic; stainless steel is not always suitable for induction cooking.

- **Cast iron** cooks evenly and is also good for induction cooking. Do not slide cast iron cookware on the cooktop; cast iron cookware with a rough surface will scratch the glass-ceramic cooktop.
- **Porcelain-enamel-coated metals** have variable heating characteristics depending on the quality of the base metal. Make sure the porcelain-enamel coating is smooth to avoid scratching the glass-ceramic cooktop.

Cookware Placement

Use the proper cookware and place it correctly on the cooktop. One or more of the cooking elements will not heat if any of the incorrect conditions shown is detected by the sensors located below the glass-ceramic cooktop surface. Correct the problem before attempting to use the cooktop.

- | | Correct | Incorrect |
|---|---------|-----------|
| • Center cookware on surface of cooking element. | | |
| • Use pans with flat bottom and straight sides. | | |
| • Diameter of pan is equal to or larger than cooking element. | | |
| • Pan rests completely on the cooktop surface. | | |
| • Pan is properly balanced. | | |

Burner	Round Pan (Diameter)	Rectangular Pan (W x L)
Front	5 1/2" to 7" (14 to 18 cm)	7" X 8 11/16" (18 X 22 cm)
Rear	5 1/2" to 7" (14 to 18 cm)	7" X 8 11/16" (18 X 22 cm)
Flexible	7" to 8 11/16" (18 to 22 cm)	14 3/16" X 8 11/16" (36 X 22 cm)

NOTE

- The sensor detects the diameter of the pan based on the surface which is in actual contact with the cooking element.
- The base of the cookware may be too small for the burner even if the top opening is large enough.

Moving Cookware on the Cooktop

Always use heavier gauge, high-quality cookware on the cooking elements and do not slide it on the glass-ceramic cooktop surface. Even high-quality cookware can scratch the cooktop surface.

NOTE

- Always lift cookware before moving it on the glass-ceramic surface. Any cookware that has a rough or dirty bottom can mark and scratch the cooktop surface. Always start with clean cookware.
- Do not allow aluminum foil or any material that can melt to make contact with the glass-ceramic cooktop. If these materials melt on the cooktop they may damage the glass-ceramic surface.

Sliding any type of cookware over the surface will scratch the cooktop over time. Scratches will make cleaning the glass-ceramic cooktop difficult and degrade the appearance of the cooktop.

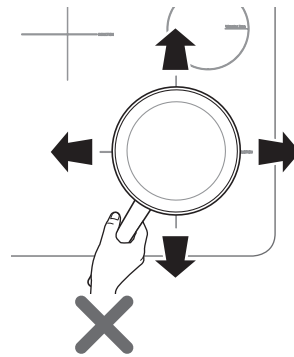

Pan Sensing

The cooking-element sensors located below the cooktop surface require certain cookware conditions to be met before the induction cooking elements can operate.

The cooking zone LED bar may display a pan sensing error message. If a cooking element is activated and no cookware is detected, the affected induction cooking zone LED bar will fluctuate. If the cookware does not meet the correct conditions, the cooking zone may not heat.



If the problem is not corrected, the affected cooking element will automatically deactivate within 30 seconds.

Setting Surface Controls

• Cooking Element LED Bar

There are LED bars located at the front of the induction cooktop surface. The LED rings on the control knobs also indicate the power level of the elements while in use.

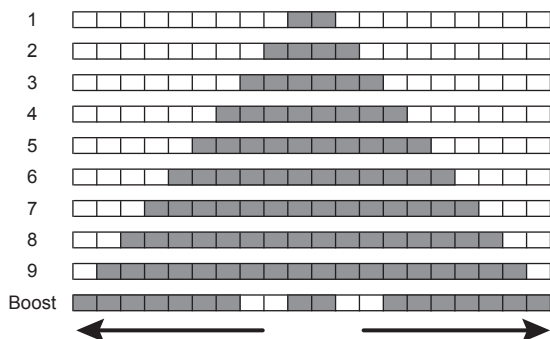

• Available Power Level Settings

LED bars display the element's power level settings, ranging from 1 to 9 to Boost. Adjust the settings in increments of one, from 1 to Boost. To select 9, turn the knob clockwise to 9.

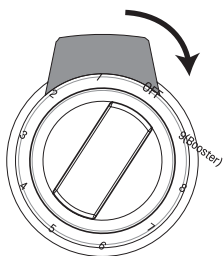

• Boost Power Level

To activate the Boost mode, turn the knob counterclockwise from Off to 9. Boost mode is only available immediately after activating a cooking element. When the cooking element is set to the Boost mode, the LED bar flashes and the Boost mode stays in operation for up to 10 minutes. After 10 minutes, the cooking element automatically returns to level 9. When Boost mode is set on one induction element, turning on the other element cancels Boost mode on the first.

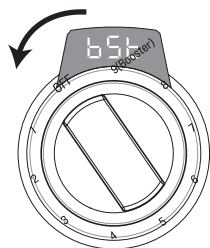

Hot Surface Indicator

The hot surface indicator light glows as long as any surface cooking area is too hot to touch.

It remains on after the element is turned off and until the surface has cooled to approximately 120 °F (50 °C).

It is normal for the surface elements to cycle on and off when cooking at lower temperature settings.

Using the Cooking Elements

⚠ CAUTION

Before Cooking

- Do not place or store flammable or heat-sensitive items on the induction cooktop, even when the cooktop is not in use.
- Place cookware on the cooking elements before turning on the induction cooktop.
- Do not place sealed containers on the cooktop.

During Cooking

- Do not place metallic objects such as knives, forks, spoons, and lids on the induction cooktop surface; they can get hot.
- Use this appliance only for normal household use. It is not designed for commercial or industrial use.
- Never use the appliance to heat the room.
- Use caution when plugging electrical appliances into power outlets near the cooktop. Keep power cords from any contact with the cooktop or cookware.
- Overheated fat and oil can catch fire quickly. Never leave surface elements unattended when frying foods.
- Do not use the induction cooktop to heat aluminum foil, products wrapped in aluminum foil, or frozen foods packaged in aluminum cookware.
- Use caution when plugging electrical appliances into outlets near the cooktop to keep power cords away from the hot cooktop or cookware.
- Users with pacemakers and active heart implants must keep their upper body at a minimum distance of 1 ft (30 cm) from active induction cooking elements. If in doubt, consult the implant manufacturer or your doctor.

After Cooking

- After use, switch off the induction cooking element using its control. Do not rely on the pan sensor.

Turning On Cooking Elements

- 1 Push the control knob in.
- 2 Turn the knob in either direction to select the desired setting. A short beep sounds and the cooking element's LED bar shows its current setting.
- 3 To activate the Boost mode, turn the knob directly from Off to 9(Boost). Both induction elements cannot be set to Boost mode at the same time.

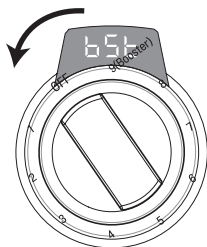

Flexible Mode

Use the Flexible mode for cookware that is too large to fit on one element. Push the Flexible button between the two control knobs to turn on Flexible mode.

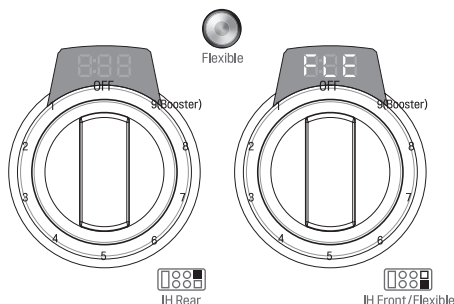

In Flexible mode, both cooking-element sensors are turned on. When larger cookware is placed on the cooktop, both elements operate simultaneously.

Using Flexible Mode

- Only the right control knob is used in Flexible mode.

- 1 Place the proper cookware on the induction cooktop.
- 2 Touch Flexible button located between induction knobs and "FLE" lights on the right knob LED.
- 3 Turn the right knob and set power level. The LED ring displays the power level.

To turn Flexible mode off, turn the right knob counterclockwise to the OFF position.

The Recommended Surface Cooking Setting

Start most surface cooking on a higher setting and then adjust to a lower setting to finish cooking.

The suggested settings may need adjustments, depending on cookware design and quality and on the amount of food being prepared.

Use quality cookware that is constructed with a magnetic base material and that meets the minimum and maximum pan size requirements.

Setting	Recommended Use
9 Boost	<ul style="list-style-type: none"> • Use to heat a large amount of food or to bring large pans of water to a boil
8	<ul style="list-style-type: none"> • Bring liquid to a boil • Start most cooking
7	<ul style="list-style-type: none"> • Hold a rapid boil, fry, deep fat fry • Quickly brown or sear food • Steaks, cutlets, grilled meat
5-6	<ul style="list-style-type: none"> • Maintain a slow boil • Fry or sauté foods • Cook soups, sauces and gravies • Eggs, pancakes
2-4	<ul style="list-style-type: none"> • Stew or steam food • Simmer
1	<ul style="list-style-type: none"> • Keep food warm • Melt chocolate or butter • Simmer

Pan Preheat Recommendations

Induction cooking may decrease the amount of time required to preheat cookware compared to cooking on a radiant element cooktop or gas surface burner. Do not use the highest settings to preheat cookware without food. The cookware will transfer too much heat to the cooktop, which will shut down automatically to avoid damage. Because it heats slowly, cast iron cookware can be preheated without food at higher settings, but for no longer than 2 minutes. After that, lower the burner setting before adding food. Pay close attention to all food items while cooking on the cooktop and until all cooking processes are complete.



CAUTION

Remember that induction surface cooking initially heats the cookware **VERY QUICKLY** if the cookware does not contain food.

If the induction cooktop becomes overheated, it automatically reduces the power level or turns off to prevent product damage. If the induction cooktop turns off, turn the burner controls to OFF then select a lower power level.

Set the power level to 7 when preheating large cookware like a griddle or grill plate.

Noises during Induction Operation

The electronic processes involved with induction cooking may create some background noises. You may hear a slight buzzing sound when cooking on the cooktop. These noises are part of the induction cooking process and are considered normal. Some cookware will buzz, depending on the construction or base material. The buzz may be more noticeable if the contents of the pan are cold. As the pan heats up, the noise will decrease. The noise will also decrease if the power level setting is reduced.

NOTE

- When using the induction cooktop, operational noises are more noticeable while cooking in Boost mode. But very loud noises are not normal when induction cooking.
- The cooktop fan may turn on to reduce the temperature of the product, even when the surface elements are not being used.

Power Management

The induction cooktop contains paired cooking elements, which are restricted to drawing a certain maximum amount of power. The Boost mode cannot be used when both induction elements are in use.

NOTE

- If the combined heat of the surface burners is sufficiently high, the output of the induction cooktop is reduced to avoid damage to the product.
- If the induction cooktop becomes overheated, it automatically reduces the power level or turns off to prevent product damage.
- Both elements in induction cooktop cannot use the Boost mode at the same time.

Sous Vide

Sous vide cooking uses a hot water bath to cook foods "low and slow." Use it to cook meat, fish, seafood, poultry, or vegetables. Food must be vacuum packed in pouches before placing it in the water bath.

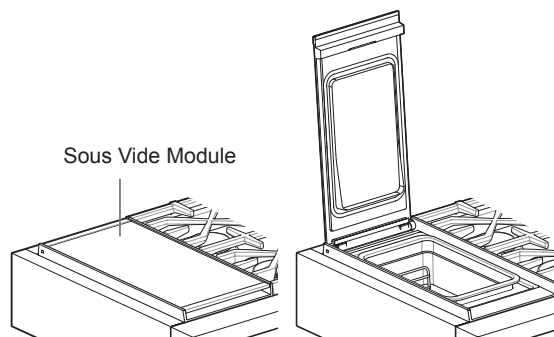

Benefits of Sous Vide

The lower temperatures and long cooking times used in sous vide cooking provide many benefits.

Healthier

Compared to other cooking methods, sous vide retains most of the original nutrients in food.

Safe and Convenient

The long cooking times used in sous vide cooking allow food to be pasteurized. Because food is vacuum packed before cooking, the unopened pouches can be quickly chilled then easily stored after cooking.

Crisp and Moist Results

The fine temperature control of sous vide cooking is an excellent way to achieve the perfect texture when cooking meat and poultry. The low temperatures used retain more of the moisture in food than conventional cooking methods. After cooking, a final sear in a frying pan adds the perfect crisp finish.

Vacuum Sealing

For best results, use a vacuum sealer and food-grade plastic pouches when sous vide cooking.

- 1 Season food as desired and vacuum seal it in a plastic pouch.
- 2 Check the pouch to make sure it is airtight and completely sealed.

NOTE

- Do not attempt to package objects with sharp points that could penetrate and tear the plastic, such as fish bones or hard shells.

Using Sous Vide

- 1 Open the cover of the sous vide module and remove the water bath.
- 2 Check the bottom of the water bath and inside the module for water or debris. Clean the bath and the module if necessary.
- 3 Fill the bath with water between the Max and Min lines.
- 4 Place the filled water bath in the sous vide module and put the rack in the bath.
- 5 Close the module cover completely.
- 6 Turn the Sous Vide Temp knob to set the desired cooking temperature.
- 7 If preheating: When the preheating alarm sounds, open the sous vide cover and place sealed food pouches on the rack in the water bath.
- 8 Turn the Sous Vide timer knob to set the desired cooking time.
- 9 When cooking is complete, open the sous vide module cover and remove the food pouches with tongs.
- 10 Return the Temp knobs to the OFF position.
- 11 Allow the water bath to cool, then remove the bath and drain the water.

CAUTION

- When opening the cover, beware of escaping steam and hot condensed water. There is a danger of scalding.
- Remember to return the Sous Vide Temp knob to the OFF position after use.
- When the cover is opened after sous vide cooking, steam may condense and fall into the module. Once the module cools, remove any moisture with a dry towel.
- Raw or unpasteurized food must never be served to highly susceptible immune compromised individuals. The US Food Code recommends that for safety, foods should not be kept between 41°F/5°C and 135°F/57°C for longer than four hours.

NOTE

- If there is no water in the water bath, the alarm sounds and "HS" appears in the knob display.

Using the Rack

Always use the rack when cooking in the sous vide module. The rack helps prevent food from resting on the bottom of the water bath, which could cause it to cook unevenly. Install the rack with the handles facing up as shown.

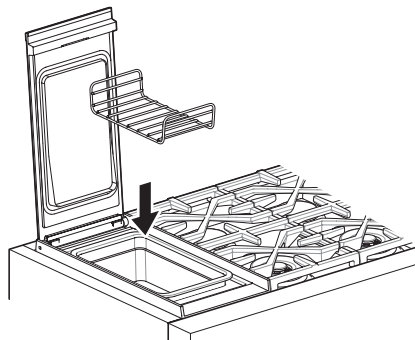

Cooking without Preheating

To use the sous vide module without preheating, follow the previous instructions under "Using Sous Vide" but place the sealed food pouches on the rack in the water bath in step 4. Simply ignore the preheating alarm.

Tips for Sous Vide Cooking

- Make sure food pouch is fully submerged in the water bath. If it does not submerge on its own, use a heatproof plate or bowl to weigh it down while cooking.
- For faster preheating times and cooking times, cover the water bath.
- Adding a flavorful oil inside the pouch, like extra virgin olive oil, can enhance the results. The additional fat acts as an insulator to keep leaner cuts of protein moist and can also be used as part of the sauce for the food item.
- As a general rule, leaner cuts of meat, poultry, fish, and shellfish take less time to cook. Tougher cuts take longer. The size and number of items being cooked also affects the time and temperature necessary to cook the food.
- The texture of foods after sous vide cooking may be different than you expect. This texture isn't wrong, just different. Food will be consistently more juicy and tender than when using conventional cooking methods.
- Keep in mind that larger or heavier items will raise the water level when placed into the water bath. The first few times, you may have to test the water level by placing the food pouch briefly in the bath before heating.

- For longer cooking times, you may need to add water during cooking to keep the water level above the minimum line in the water bath.
- Food-safe plastic vacuum-sealing bags are safe for cooking. Look for bags that are BPA-free and designed for cooking.
- Vacuum-sealed bags are an anaerobic (oxygen-free) environment. To prevent anaerobic bacteria from forming inside pouches, keep closed pouches refrigerated before and after cooking. If cooking pouches for later use, plunge pouches into ice water immediately after cooking to bring temperature down quickly, then store pouches in refrigerator or freezer.
- As with any perishable food, avoid leaving vacuum-sealed food in the USDA mandated danger zone (40°F to 140°F or 4°C to 60°C) for a prolonged period of time, and make sure the food reaches a safe internal temperature for consumption.
- One of the main causes of food-borne illness is improper storage methods for cooked foods. Using the refrigerator to cool down hot food can reintroduce bacteria to food. Store leftovers in small, shallow containers that cool down faster, and allow them to come to room temperature before refrigerating.
- Don't try to vacuum seal food that is hot, frozen or really wet. The vacuum sealer will not be able to properly seal these items.
- For best results, seal food in portion sizes and in a single layer. The food cooks faster and is less likely to spend time in the USDA danger zone.
- Don't crowd the water bath. Better results are achieved when there is plenty of water between the food and the walls of the water bath.

Moving the Sous Vide Bath

Some users may find it more convenient to place the empty water bath in the sous vide module before filling it with water for cooking. After cooking, allow the water bath to cool before removing water with a large measuring cup until the water bath is light enough to easily lift out. If following this method, take care not to spill water into the sous vide cavity before or after cooking.

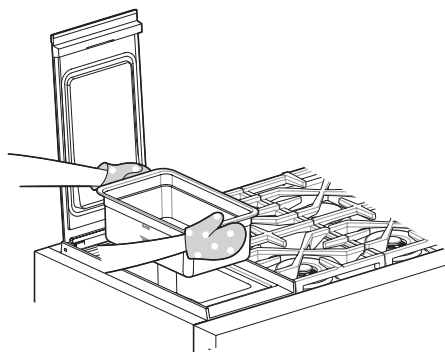

CAUTION

- Do not remove the water bath until it has fully cooled. The hot water can scald or spill, and the hot bath may damage countertops.
- Use sturdy tongs to place pouches in or remove them from the hot water bath. Do not use bare hands.
- Surface of rangetop can become hot when sous vide cooking.
- If the water bath must be moved when the cooktop is in use, use oven mitts and take care not to let arms touch hot cookware or hot surfaces on the cooktop.
- Avoid spilling water onto the cooktop or into the sous vide cavity.

Setting Sous Vide Temperature

Set the sous vide temperature before setting the cook time. Turn the control knob to select one of the default temperatures on the knob.

To select a temperature in between the defaults, turn the knob to the nearest default temperature. Then turn the LED ring behind the knob left or right repeatedly to increase or decrease the temperature in 1-degree increments. The available temperature range is 120 °F to 200 °F (49 °C to 93 °C).

For example, to set 168 °F

- 1 Place the knob at 170 °F. The display shows 170 °F.

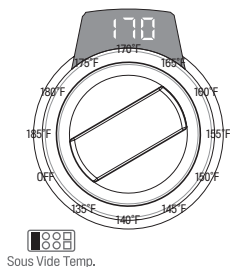

- 2 Turn the LED ring counterclockwise twice to set 168 °F.

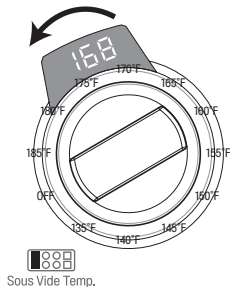

Setting Sous Vide Cook Time

Turn the control knob to select one of the default cook times.

To set a time in between the defaults, turn the knob to the closest default time. Then turn the LED ring behind the knob left or right repeatedly to increase or decrease the time in 1-minute increments. The cook time can be set for any time between 1 minute and 48 hours.

For example, to set 33 min.

- 1 Place the knob at 30 min. The display shows 30 min.

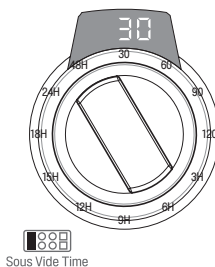

- 2 Turn the LED ring clockwise 3 times to set 33 minutes.

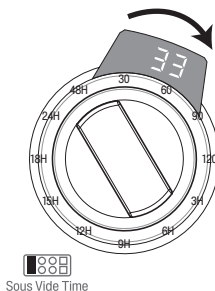

Assembling the Water Bath

- Proper placement of the water bath is important for the sous vide sensor to detect the water temperature in the bath and heat the water properly.
- To avoid damaging the sous vide cover, make sure the water bath is installed correctly before closing the cover.
- Keep the sous vide cavity and the bottom of the water bath free from water or debris. Failure to do so could cause poor heater performance or a fire.

Correct

- Water bath is centered correctly on surface of heater.
- Use the water bath provided with the product.
- There should be no debris or water on the heater surface or the bottom of the water bath.



Incorrect

- Bottom of water bath is not in full contact with the heater.
- Use of third party water bath.
- Debris or water between water bath and heater.

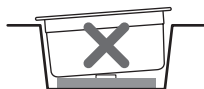

Filling the Water Bath

- Use only clean water in the water bath.
- After use, empty the water bath and clean it before reusing it.
- Do not reuse water after cooking. Doing so may cause illness.
- For best results, fill bath with water at 68°F (20°C) and keep the water level between the Max and Min lines even after the addition of food.
- Food should be completely immersed in water. Add water if necessary.
- If the food pouch floats in the water, place a dish or cooking weights on top of the pouch.

NOTE

- Keep the Sous Vide module and water bath exterior free from water or debris when not in use. If needed, clean and dry both before using.
- Take care to avoid spilling water into the product when loading the water bath.

Sous Vide Cooking Guide

The cooking times listed are approximate only, as each type of food to be cooked is different in nature and consistency. When cooking frozen food, increase the cooking times. Consult a sous vide cookbook or online guide for more details.

Food		Water Temp. (°F)	Time (mins.)
Steak (1-1.5"), Rib eye, Top loin, T-bone, Porterhouse	Medium	135	120-180
	Well done	158	45-180
Pork (1-2") chops, boneless	Medium rare	140	60-150
	Medium well	149	60-150
Chicken (1-1.5") breast, boneless	Tender	140	90-180
	Firm	149	60-180
Vegetables	Root	185	60-240
	Tender		20-60
Fish (1-1.5") Fillet, Steak	Medium well	140	40-90
Eggs, Grade A large Whole, In Shell	Soft boiled	167	15-30
	Hard boiled	167	45-90

SMART FUNCTIONS

LG ThinQ Application

This feature is only available on models with Wi-Fi.

The **LG ThinQ** application allows you to communicate with the appliance using a smartphone.

LG ThinQ Application Features

- **Smart Diagnosis™**

- This function provides useful information for diagnosing and solving issues with the appliance based on the pattern of use.

- **Monitoring**

- This function helps you check the current status, remaining time, cook settings and end time in one place.

- **Usage History**

- See the total usage time for each burner by day, week, or month.

- **Product Notifications**

- Turn on the Push Alerts to receive appliance status notifications. The notifications are triggered even if the **LG ThinQ** application is not open.

NOTE

- If you change your wireless router, Internet service provider, or password, delete the registered appliance from the **LG ThinQ** application and register it again.
- This information is current at the time of publication. The application is subject to change for product improvement purposes without notice to users.

Installing LG ThinQ Application and Connecting an LG Appliance

Models with QR Code

Scan the QR code attached to the product using the camera or a QR code reader application on your smartphone.



Models without QR Code

- 1 Search for and install the **LG ThinQ** application from the Google Play Store or Apple App Store on a smartphone.
- 2 Run the **LG ThinQ** application and sign in with your existing account or create an LG account to sign in.
- 3 Touch the add (+) button on the **LG ThinQ** application to connect your LG appliance. Follow the instructions in the application to complete the process.

NOTE

- To verify the Wi-Fi connection, check that the Wi-Fi indicator on the control panel is lit.
- The appliance supports 2.4 GHz Wi-Fi networks only. To check your network frequency, contact your Internet service provider or refer to your wireless router manual.
- **LG ThinQ** is not responsible for any network connection problems or any faults, malfunctions, or errors caused by network connection.
- The surrounding wireless environment can make the wireless network service run slowly.
- If the distance between the appliance and the wireless router is too far, the signal becomes weak. It may take a long time to connect or fail to install the application.
- If the appliance is having trouble connecting to the Wi-Fi network, it may be too far from the router. Purchase a Wi-Fi repeater (range extender) to improve the Wi-Fi signal strength.
- The network connection may not work properly depending on the Internet service provider.
- The Wi-Fi may not connect or the connection may be interrupted because of the home network environment.
- If the appliance cannot be connected due to problems with the wireless signal transmission, unplug the appliance and wait about a minute before trying again.
- If the firewall on your wireless router is enabled, disable the firewall or add an exception to it.
- The wireless network name (SSID) should be a combination of English letters and numbers. (Do not use special characters.)
- Smartphone user interface (UI) may vary depending on the mobile operating system (OS) and the manufacturer.
- If the security protocol of the router is set to **WEP**, network setup may fail. Change the security protocol (**WPA2** is recommended), and connect the product again.

Smart Diagnosis™ Function

Should you experience any problems with the appliance, it has the capability of transmitting troubleshooting data to the LG ThinQ application on a smartphone.

LG ThinQ Smart Diagnosis™

Use the Smart Diagnosis feature in the LG ThinQ application for help diagnosing issues with the appliance without the assistance of the SKS Customer Information Center.

Follow the instructions in the LG ThinQ application to perform a Smart Diagnosis using your smartphone.

- 1 Download the LG ThinQ application on your smart phone.
- 2 Open the LG ThinQ application on your smart phone. Touch the Smart Diagnosis™ button to advance to the next screen.
- 3 Follow the directions in the application.
- 4 Touch [?] in the LG ThinQ application for a more detailed guide on how to use the Wi-Fi function.

NOTE

- Smart Diagnosis™ cannot be activated unless the appliance can be turned on. If the appliance cannot be turned on, troubleshooting must be done without using Smart Diagnosis™.

Open Source Software Notice Information

To obtain the source code under GPL, LGPL, MPL and other open source licenses, that is contained in this product, please visit <https://opensource.lge.com>. In addition to the source code, all referred license terms, warranty disclaimers and copyright notices are available for download.

LG Electronics will also provide open source code to you on CD-ROM for a charge covering the cost of performing such distribution (such as the cost of media, shipping, and handling) upon email request to opensource@lge.com. This offer is valid for a period of three years after our last shipment of this product. This offer is valid to anyone in receipt of this information.

Radio Equipment Specifications

Type	Operating Frequency Range	Output Power (Max.)
Wireless LAN	2 400 MHz - 2 472 MHz	< 1 W
Bluetooth†	2 400 MHz - 2 483.5 MHz	

† This feature is only available on some models.

FCC Notice

The following notice covers the transmitter module contained in this product.

This equipment has been tested and found to comply with the limits for a Class B digital device, pursuant to Part 15 of the FCC Rules and also Part 18 of the FCC Rules. These limits are designed to provide reasonable protection against harmful interference in a residential installation. This equipment generates, uses, and can radiate radio frequency energy and, if not installed and used in accordance with the instructions, may cause harmful interference to radio communications. However, there is no guarantee that interference will not occur in a particular installation. If this equipment does cause harmful interference to radio or television reception, which can be determined by turning the equipment off and on, the user is encouraged to try to correct the interference by one or more of the following measures:

- Reorient or relocate the receiving antenna.
- Increase the separation between the equipment and the receiver.
- Connect the equipment into an outlet on a circuit different from that to which the receiver is connected.
- Consult the dealer or an experienced radio/TV technician for help.

This device complies with Part 15, Part 18 of the FCC Rules. Operation is subject to the following two conditions:

- 1) This device may not cause harmful interference and
- 2) This device must accept any interference received, including interference that may cause undesired operation.

Any changes or modifications in construction of this device which are not expressly approved by the party responsible for compliance could void the user's authority to operate the equipment.

FCC Statement

This equipment generates and uses ISM frequency energy and if not installed and used properly, that is in strict accordance with the manufacturer's instructions, may cause interference to radio and television reception. It has been type tested and found to comply with limits for ISM Equipment pursuant to part 18 FCC Rules, which are designed to provide reasonable protection against such interference in a residential installation.

However there is no guarantee that interference will not occur in a particular installation. If this equipment does cause interference to radio or television reception, which can be determined by turning the equipment off and on, the user is encouraged to try to correct the interference by one or more of the following:

- Reorient or relocate the receiving antenna of the radio or television.
- Increase the separation between the equipment and receiver.
- Connect the equipment into an outlet on a circuit different from that to which the receiver is connected.
- Consult the dealer or an experienced radio/TV technician for help.

The manufacture is not responsible for any radio or TV interference caused by unauthorized modification to this equipment. It is responsibility of the user to correct such interference.

FCC RF Radiation Exposure Statement

This equipment complies with FCC radiation exposure limits set forth for an uncontrolled environment. This transmitter must not be co-located or operating in conjunction with any other antenna or transmitter.

This equipment should be installed and operated with a minimum distance of 20 cm (7.8 inches) between the antenna and your body. Users must follow the specific operating instructions for satisfying RF exposure compliance.

MAINTENANCE

NOTE

- Depending on the model, your appliance may contain different cooktop modules requiring different maintenance procedures. Take care when cleaning the appliance to apply cleaners only as recommended.

CAUTION

- Do not clean this appliance with bleach.
- To prevent burns, wait until the cooktop has cooled down before touching any of its parts.
- Always wear gloves when cleaning the cooktop.
- Do not block the vents and air openings of the rangetop. They provide the air inlet and outlet that are necessary for the rangetop to operate properly with correct combustion.

Control Panel

Clean up splatters with a damp cloth using a glass cleaner. Remove heavier soil with warm, soapy water. Do not use abrasives of any kind.

Gas Surface Burners

Removing and Replacing the Gas Surface Burners

Grates and burner heads/caps can be removed for care and cleaning.

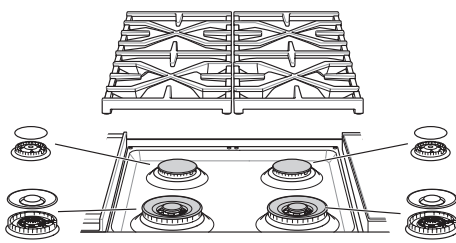

	General burner
Burner cap is properly set.	
Burner cap is NOT properly set.	

Cleaning Burner Heads/Caps

For even and unhampered flame, the slits in the burner heads must be kept clean at all times. The burner heads and caps can be lifted off.

- Wash the burner caps in hot soapy water and rinse with clean water. Run water through the burner from the bottom stem to flush out debris.
- Use care when cleaning the cooktop. The pointed metal ends on the electrodes could cause injury. Hitting an electrode with a hard object may damage it.
- To remove burnt-on food, soak the burner heads in a solution of mild liquid detergent and hot water for 20–30 minutes. For stubborn stains, use a toothbrush.
- The burners will not operate properly if the burner ports or electrodes are clogged or dirty.
- Burner caps and heads should be cleaned routinely, especially after excessive spillover.
- Burners will not light if the cap is removed.

CAUTION

- Do not hit the electrodes with anything hard. Doing so could damage them.
- Do not use steel wool or scouring powders to clean the burners.
- Do not scratch or gouge the port features of the brass burner bases.
- It is normal for brass burners to become tarnished with use.

NOTE

- To clean the brass burners, use mild abrasive cleaners or liquid cleaners.
- To clean port openings, use a stiff, nylon bristle tooth brush.
- Do not use steel wool or steel bristle brushes as they can scratch the brass burner surface.

After Cleaning the Burner Heads/Caps

Shake out any excess water and then let them dry thoroughly. Placing the burner upside down will allow the water to drain out more easily. Replace the burner heads and caps over the electrodes on the cooktop in the correct locations according to their size. Make sure the hole in the burner head is positioned over the electrode.

Burner Grates

The convertible wok grates should be used in the front, and the remaining grates in the back.

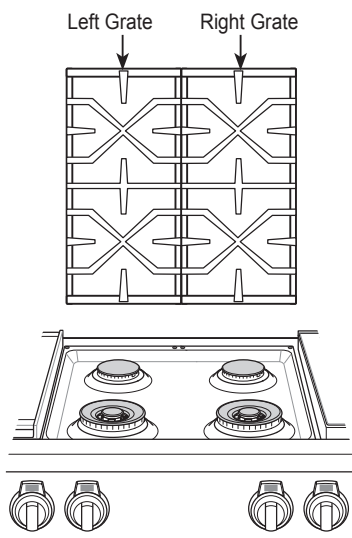

NOTE

Do not operate a burner for an extended period of time without cookware on the grate. The finish on the grate may chip without cookware to absorb the heat.

Cleaning the Burner Grates

CAUTION

- Do not lift the grates out until they have cooled.
- Do not put the grate in an oven during self cleaning mode.
- Grates should be washed regularly and after spillovers.
- Wash the grates in hot, soapy water and rinse with clean water.
- After cleaning the grates, let them dry completely and securely position them over the burners.

Gas Cooktop Surface

CAUTION

- To avoid burns, do not clean the cooktop surface until it has cooled.
- Do not lift the cooktop surface. Lifting the cooktop surface can lead to damage and improper operation of the rangetop.
- When water is spilled on the cooktop, wipe up water immediately. If water is left on the cooktop for a long time, discoloration may occur.

Foods with high acid or sugar content may cause a dull spot if allowed to set. Wash and rinse soon after the surface has cooled. For other spills such as oil/grease spattering, etc., wash with soap and water when the surface has cooled, then rinse and polish with a dry cloth.

Sous Vide Module

⚠ CAUTION

- The sous vide handle may become hot during operation. Use oven mitts when handling during and after use.
 - Allow the water bath to cool before removing it. Wear oven mitts when removing the water bath. Do not touch the heater under the bath.
 - Avoid spilling water into the sous vide module when moving the filled water bath.
 - Remove the condensation from opening the sous vide cover with a dry towel.
 - Do not use abrasive cleansers or scouring pads to clean the sous vide module. They will scratch the surface.
- Clean the outside of the sous vide module with a soft, damp cloth or sponge, using mild dish soap and warm water.
 - To clean the inside of the module, use a paper towel or soft clean cloth to wipe off food or liquids. Dampen a soft cloth with mild soapy water and gently wipe clean.
 - After cleaning, thoroughly wipe dry with a soft, clean cloth.

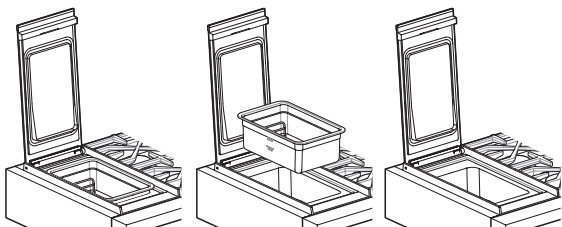

Induction Cooktop

⚠ CAUTION

- Do not use glass-ceramic cooktop cleaners on other rangetop surfaces.
- Do not use scrub pads or abrasive cleaning pads. They may damage the induction surface.
- For your safety, use an oven mitt or pot holder when using the scraper to clean the hot cooking surface.
- Read and follow all instructions and warnings on the cleaning cream label.

Use only glass-ceramic induction cooktop cleaner on the induction cooktop. Other creams may not be as effective or may scratch, damage or stain the induction cooktop.

To maintain and protect the induction cooktop surface, follow these instructions:

- 1 Before using the induction cooktop for the first time, clean it with a glass-ceramic induction cooktop cleaner. This helps protect the top and makes cleanup easier.
- 2 Shake the cleaning cream well. Apply a few drops of cleaner directly to the induction cooktop.
- 3 Use a paper towel to clean the entire induction cooktop surface.
- 4 Rinse with clear water and use a dry cloth or paper towel to remove all cleaning residue.

NOTE

- Do not heat the induction cooktop until it has been cleaned thoroughly.
- Use glass-ceramic Induction cleaner daily to help keep the cooktop looking new.

IMPORTANT

If any sugar or food containing sugar (preserves, ketchup, tomato sauce, jellies, fudge, candy, syrups, chocolate) spills, or plastic or foil melts on the induction cooktop, remove the molten material IMMEDIATELY with a metal razor scraper (it will not damage the decorated cooking surface) while the cooking surface is still hot to avoid the risk of damage to the glass-ceramic surface. For your safety, please use an oven mitt or pot holder while scraping the hot cooking surface.

Burned-On Residue

Follow these instructions to remove burned on residue from the glass-ceramic induction cooktop surface.

- 1 While the induction cooktop is still hot, remove any burned on deposits or spilled food from the glass-ceramic cooking surface with a suitable metal razor scraper. (Similar to scraping paint off of a windowpane, it will not damage the decorated cooking surface.) Hold the scraper at a 30° angle to the induction cooktop.

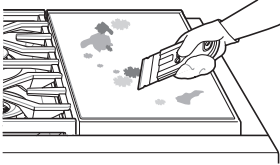

NOTE

- Do not use a dull or nicked blade.
- To prevent burns, wear an oven mitt or pot holder while using the metal scraper.

- 2 When the cooking surface has cooled down, apply a few dabs (about the size of a dime) of a glass-ceramic cooktop cleaner in each burner area and work the cleaning cream over the induction cooktop surface with a damp paper towel.

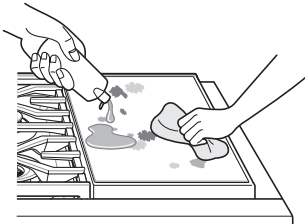

- 3 Rinse with clean water and wipe the induction cooktop surface with a clean, dry paper towel.

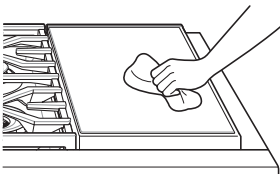

Metal Marks and Scratches

- Be careful not to slide pots and pans across the induction cooktop. Doing so will leave metal markings on the surface.
- To help remove these marks, use a glass-ceramic induction cooktop cleaner with a cleaning pad made for use with glass-ceramic induction cooktops.

CAUTION

Cookware with rough or uneven bottoms can mark or scratch the induction surface.

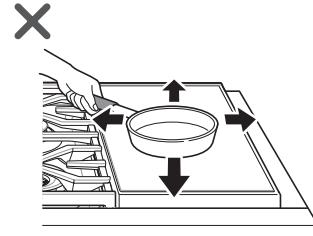

- Do not slide metal or glass across the induction surface.
- Do not use cookware with any dirt build-up on the bottom.

Exterior

Painted and Decorative Trim

For general cleaning, use a cloth with hot soapy water. For more difficult soils and built-up grease, apply a liquid detergent directly onto the soil. Leave it on for 30 to 60 minutes. Rinse with a damp cloth and dry. Do not use abrasive cleaners.

Stainless Steel Surfaces

To avoid scratches, do not use steel wool pads.

- 1 Place a small amount of stainless steel appliance cleaner or polish on a damp cloth or paper towel.
- 2 Clean a small area, rubbing with the grain of the stainless steel if applicable.
- 3 Wipe with a clean, dry paper towel or soft cloth.
- 4 Repeat as necessary.

NOTE

- Use warm soapy water or a stainless steel cleaner or polish.
- Always wipe in the direction of the metal surface finish.
- Stainless steel appliance cleaner or polish can be purchased online or from most retailers of appliances or home goods.

Front Manifold Panel and Knobs

It is best to clean the manifold panel after each use of the rangetop. To clean, use a damp cloth and mild soapy water or a 50/50 solution of vinegar and water. Rinse with clean water and polish dry with a soft cloth.

The control knobs may be removed for easy cleaning.

- 1 To clean the knobs, make sure that they have the position indicator centered at the top or **Off** position and pull them straight off the stems.
- 2 To replace the knobs, make sure that the knobs have the position indicator centered at the top or **Off** position, and slide the knobs directly onto the stem.

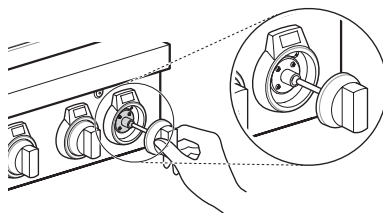

CAUTION

- Do not use abrasive cleansers, strong liquid cleaners, plastic scouring pads or oven cleaners on the manifold panel. Doing so will damage the finish.
- Do not try to bend the knobs by pulling them up or down, and do not hang a towel or other objects on them. This can damage the gas valve shaft.
- Do not try to remove the LED rings behind the control knobs.

NOTE

To prevent scratching, do not use abrasive cleaners on any of these materials.

Remove debris which collects in the crevices with a folded cloth or table knife.

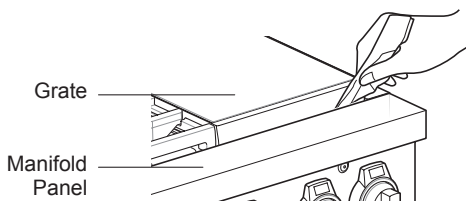

NOTE

Take care not to scratch the surface.

TROUBLESHOOTING

FAQs

What types of cookware are recommended for use with the induction cooktop?

- The pans must have a flat bottom and straight sides.
- Only use heavy-gauge pans.
- The pan size must match the amount of food to be prepared and the size of the surface element.
- Use tight fitting lids.
- Only use flat-bottom woks or 14" round-bottom woks when using a SKS supplied wok grate.
- Pans used with the induction cooktop must have a magnetic base.

Why do the heating elements appear to be turning ON and OFF during use of the cooktop?

Depending on your cooktop element setting it is NORMAL for the cooking elements to cycle on and off.

What should I do for hard to remove stains on my induction cooktop?

The induction cooktop should be cleaned after every use to prevent permanent staining. When cooking foods with high sugar content, such as tomato sauce, clean the stain off with a scraper while the cooktop is still warm. Use an oven mitt when scraping to prevent burns. Refer to the MAINTENANCE section of this owner's manual for further details on cleaning the induction cooktop.

Before Calling for Service

Before you call for service, review this list. It may save you time and expense. The list includes common occurrences that are not the result of defective workmanship or materials in this appliance.

For detailed information or videos, visit www.lg.com for the troubleshooting page.

Symptoms	Possible Causes / Solutions
Induction control beeps and LED on knob displays F33~F45 error code.	<ul style="list-style-type: none"> Electronic control error. Turn the knob to the central OFF position in order to clear the display and stop beeping. If fault recurs, record fault number. Turn the knob to the central OFF position and call for service.
Sous-Vide control beeps and LED on knob displays F62 error code.	<ul style="list-style-type: none"> Electronic control error. Turn the knob to the central OFF position in order to clear the display and stop beeping. If fault recurs, record fault number. Turn the knob to the central OFF position and call for service.
Gas cooktop burners do not light or do not burn evenly.	<ul style="list-style-type: none"> Make sure that the appliance is properly connected to electrical supply and grounded. Remove the burners and clean them. Check the electrode area for burnt on food or grease. See Cleaning Burner Heads/Caps in the MAINTENANCE section. Make sure that the burner parts are installed correctly. See Removing and Replacing the Gas Surface Burners in the MAINTENANCE section.
Burner flames are very large or yellow.	<ul style="list-style-type: none"> If the rangetop is connected to LP gas, contact the technician who installed your rangetop or made the conversion.
Appliance does not operate.	<ul style="list-style-type: none"> Make sure that the appliance is properly connected to electrical supply. Check circuit breakers. Service wiring is not complete. Contact your electrician for assistance. Power outage. Check house lights to be sure. Call your local electric company for service.
Trouble connecting appliance and smartphone to Wi-Fi network	<ul style="list-style-type: none"> The password for the Wi-Fi network was entered incorrectly. <ul style="list-style-type: none"> Delete your home Wi-Fi network and begin the registration process again. Mobile data for your smartphone is turned on. <ul style="list-style-type: none"> Turn off the Mobile data on your smartphone before registering the appliance. The wireless network name (SSID) is set incorrectly. <ul style="list-style-type: none"> The wireless network name (SSID) should be a combination of English letters and numbers. (Do not use special characters.) The router frequency is not 2.4 GHz. <ul style="list-style-type: none"> Only a 2.4 GHz router frequency is supported. Set the wireless router to 2.4 GHz and connect the appliance to the wireless router. To check the router frequency, check with your Internet service provider or the router manufacturer. The distance between the appliance and the router is too far. <ul style="list-style-type: none"> If the appliance is too far from the router, the signal may be weak and the connection may not be configured correctly. Move the router closer to the appliance or purchase and install a Wi-Fi repeater.
The sous vide module beeps during operation	<ul style="list-style-type: none"> This alert sounds when the sous vide module is operated without water in the water bath. <ul style="list-style-type: none"> Fill the water bath to the recommended level before using.
The sous vide control knob LED shows "HS"	<ul style="list-style-type: none"> The water level has fallen below the Minimum mark in the water bath. <ul style="list-style-type: none"> Add water to the water bath. The temperature of the water in the water bath is very high. <ul style="list-style-type: none"> Allow the water to cool before handling the water bath.

WARRANTY

USA

TERMS AND CONDITIONS

ARBITRATION NOTICE: THIS LIMITED WARRANTY CONTAINS AN ARBITRATION PROVISION THAT REQUIRES YOU AND LG ELECTRONICS (“LG”) TO RESOLVE DISPUTES BY BINDING ARBITRATION INSTEAD OF IN COURT, UNLESS YOU CHOOSE TO OPT OUT. IN ARBITRATION, CLASS ACTIONS AND JURY TRIALS ARE NOT PERMITTED. PLEASE SEE THE SECTION TITLED “PROCEDURE FOR RESOLVING DISPUTES” BELOW.

Should your **LG** Rangetop ("Product") fail due to a defect in materials or workmanship under normal and proper use, during the warranty period set forth below, **LG** will, at its option, repair or replace the Product. This limited warranty is valid only to the original retail purchaser of the Product and applies only when purchased lawfully and used within the United States including U.S. Territories.

Warranty Period	Scope of Warranty	HOW SERVICE IS HANDLED
Three (3) years from the date of original retail purchase, or from the date of delivery as per applicable law	Parts and Labor	LG will provide parts and labor to repair or replace defective parts.

- Replacement Products and parts are warranted for the remaining portion of the original warranty period or ninety (90) days, whichever is greater.
- Replacement Products and parts may be new, reconditioned, refurbished, or otherwise factory remanufactured.
- Replaced Product or part(s) will be the property of **LG**.
- Proof of original retail purchase specifying the Product model and date of purchase is required to obtain warranty service under this limited warranty.

EXCEPT TO THE EXTENT PROHIBITED BY APPLICABLE LAW, ANY IMPLIED WARRANTY OF MERCHANTABILITY OR FITNESS FOR A PARTICULAR PURPOSE ON THE PRODUCT IS LIMITED IN DURATION TO THE DURATION OF THE ABOVE LIMITED WARRANTY. UNDER NO CIRCUMSTANCES SHALL LG OR ITS U.S. DISTRIBUTORS/DEALERS BE LIABLE FOR ANY INDIRECT, INCIDENTAL, CONSEQUENTIAL, SPECIAL, OR PUNITIVE DAMAGES, INCLUDING, WITHOUT LIMITATION, LOST GOODWILL, LOST REVENUES OR PROFITS, WORK STOPPAGE, IMPAIRMENT OF OTHER GOODS, COST OF REMOVAL AND REINSTALLATION OF THE PRODUCT, LOSS OF USE, OR ANY OTHER DAMAGES WHETHER BASED IN CONTRACT, TORT, OR OTHERWISE. LG'S TOTAL LIABILITY, IF ANY, SHALL NOT EXCEED THE PURCHASE PRICE PAID BY YOU FOR THE PRODUCT.

SOME STATES DO NOT ALLOW THE EXCLUSION OR LIMITATION OF INCIDENTAL OR CONSEQUENTIAL DAMAGES OR LIMITATIONS ON HOW LONG AN IMPLIED WARRANTY LASTS, SO THE ABOVE EXCLUSIONS OR LIMITATIONS MAY NOT APPLY TO YOU. THIS LIMITED WARRANTY GIVES YOU SPECIFIC LEGAL RIGHTS AND YOU MAY ALSO HAVE OTHER RIGHTS THAT VARY FROM STATE TO STATE.

THIS LIMITED WARRANTY DOES NOT COVER:

- Service trips to deliver, pick up, or install, educate how to operate, correct wiring, or correct unauthorized repairs.
- Damage or failure of the Product to perform during power failures and interrupted or inadequate electrical service.
- Damage or failure caused by leaky or broken water pipes, frozen water pipes, restricted drain lines, inadequate or interrupted water supply or inadequate supply of air.
- Damage resulting from operating the product in a corrosive atmosphere or contrary to the product owner's manual.
- Damage or failure to the Product caused by accidents, pests and vermin, lightning, wind, fire, floods, acts of God, or any other causes beyond the control of **LG**.

- Damage or failure of the Product caused by unauthorized modification or alteration, or if the Product is used for other than the intended purpose, or any water leakage where the Product was not properly installed.
- Damage or failure of the Product caused by incorrect electrical current, voltage, or plumbing codes.
- Damage or failure of the Product caused by transportation, storage, and/or handling, including scratches, dents, chips, and/or other damage to the finish of the Product, unless such damage is reported within one (1) week of delivery.
- Damage or failure of the Product resulting from misuse, abuse, improper installation, repair, or maintenance. Improper repair includes the use of parts not authorized by **LG**. Improper installation or maintenance includes installation or maintenance contrary to the Product owner's manual.
- Damage or failure of the Product caused by the use of parts, components, accessories, consumable cleaning products, or any other products or services that were not authorized by **LG**.
- Damage or missing items to any display or open box Product.
- Refurbished Product or any Product sold "As Is", "Where Is", "With all Faults", or similar disclaimer.
- Products with original serial numbers that have been removed, altered, or cannot be readily determined.
- Increases in utility costs and additional utility expenses.
- Any noises associated with normal operation.
- Products used for other than normal and proper household use (e.g., commercial or industrial use) or contrary to the Product owner's manual.
- Costs associated with removal and reinstallation of the Product for repairs, or the removal and reinstallation of the Product if it is installed in an inaccessible location or not installed in accordance with the Product Owner's manual.
- Accessories, removable components, or consumable parts (e.g. Shelves, door bins, drawers, water/air filters, racks, light bulbs, batteries, etc., as applicable), except for internal/functional parts covered under this limited warranty.

PROCEDURE FOR RESOLVING DISPUTES:

ALL DISPUTES BETWEEN YOU AND LG ARISING OUT OF OR RELATING IN ANY WAY TO THIS LIMITED WARRANTY OR THE PRODUCT SHALL BE RESOLVED EXCLUSIVELY THROUGH BINDING ARBITRATION, AND NOT IN A COURT OF GENERAL JURISDICTION. BINDING ARBITRATION MEANS THAT YOU AND LG ARE EACH WAIVING THE RIGHT TO A JURY TRIAL AND TO BRING OR PARTICIPATE IN A CLASS ACTION.

Definitions. For the purposes of this section, references to "LG" mean LG Electronics USA, Inc., its parents, subsidiaries and affiliates, and each of their officers, directors, employees, agents, beneficiaries, predecessors in interest, successors, assigns and suppliers; references to "dispute" or "claim" shall include any dispute, claim or controversy of any kind whatsoever (whether based in contract, tort, statute, regulation, ordinance, fraud, misrepresentation or any other legal or equitable theory) arising out of or relating in any way to the sale, condition or performance of the product or this Limited Warranty.

Notice of Dispute. In the event you intend to commence an arbitration proceeding, you must first notify LG in writing at least 30 days in advance of initiating the arbitration by sending a letter to LG at LG Electronics, USA, Inc. Attn: Legal Department- Arbitration 111 Sylvan Avenue, Englewood Cliffs, NJ 07632. You and LG agree to engage in good faith discussions in an attempt to amicably resolve your claim. The notice must provide your name, address, and telephone number; identify the product that is the subject of the claim; and describe the nature of the claim and the relief being sought. If you and LG are unable to resolve the dispute within 30 days, either party may proceed to file a claim for arbitration.

Agreement to Binding Arbitration and Class Action Waiver. Upon failure to resolve the dispute during the 30 day period after sending written notice to LG, you and LG agree to resolve any claims between us only by binding arbitration on an individual basis, unless you opt out as provided below. Any dispute between you and LG shall not be combined or consolidated with a dispute involving any other person's or entity's product or claim. More specifically, without limitation of the foregoing, any dispute between you and LG shall not under any circumstances proceed as part of a class or representative action. Instead of arbitration, either party may bring an individual action in small claims court, but that small claims court action may not be brought on a class or representative basis.

Arbitration Rules and Procedures. To begin arbitration of a claim, either you or LG must make a written demand for arbitration. The arbitration will be administered by the American Arbitration Association (“AAA”) and will be conducted before a single arbitrator under the AAA’s Consumer Arbitration Rules that are in effect at the time the arbitration is initiated (referred to as the “AAA Rules”) and under the procedures set forth in this section. The AAA Rules are available online at www.adr.org/consumer. Send a copy of your written demand for arbitration, as well as a copy of this provision, to the AAA in the manner described in the AAA Rules. You must also send a copy of your written demand to LG at LG Electronics, USA, Inc. Attn: Legal Department- Arbitration 111 Sylvan Avenue, Englewood Cliffs, NJ 07632. If there is a conflict between the AAA Rules and the rules set forth in this section, the rules set forth in this section will govern. This arbitration provision is governed by the Federal Arbitration Act. Judgment may be entered on the arbitrator’s award in any court of competent jurisdiction. All issues are for the arbitrator to decide, except that issues relating to the scope and enforceability of the arbitration provision and to the arbitrability of the dispute are for the court to decide. The arbitrator is bound by the terms of this provision.

Governing Law. The law of the state of your residence shall govern this Limited Warranty and any disputes between us except to the extent that such law is preempted by or inconsistent with applicable federal law.



Fees/Costs. You do not need to pay any fee to begin an arbitration. Upon receipt of your written demand for arbitration, LG will promptly pay all arbitration filing fees to the AAA unless you seek more than \$25,000 in damages, in which case the payment of these fees will be governed by the AAA Rules. Except as otherwise provided for herein, LG will pay all AAA filing, administration and arbitrator fees for any arbitration initiated in accordance with the AAA Rules and this arbitration provision. If you prevail in the arbitration, LG will pay your attorneys’ fees and expenses as long as they are reasonable, by considering factors including, but not limited to, the purchase amount and claim amount. Notwithstanding the foregoing, if applicable law allows for an award of reasonable attorneys’ fees and expenses, an arbitrator can award them to the same extent that a court would. If the arbitrator finds either the substance of your claim or the relief sought in the demand is frivolous or brought for an improper purpose (as measured by the standards set forth in Federal Rule of Civil Procedure 11(b)), then the payment of all arbitration fees will be governed by the AAA Rules. In such a situation, you agree to reimburse LG for all monies previously disbursed by it that are otherwise your obligation to pay under the AAA Rules. Except as otherwise provided for, LG waives any rights it may have to seek attorneys’ fees and expenses from you if LG prevails in the arbitration.

Hearings and Location. If your claim is for \$25,000 or less, you may choose to have the arbitration conducted solely on the basis of (1) documents submitted to the arbitrator, (2) through a telephonic hearing, or (3) by an in-person hearing as established by the AAA Rules. If your claim exceeds \$25,000, the right to a hearing will be determined by the AAA Rules. Any in-person arbitration hearings will be held at a location within the federal judicial district in which you reside unless we both agree to another location or we agree to a telephonic arbitration.

Opt Out. You may opt out of this dispute resolution procedure. If you opt out, neither you nor LG can require the other to participate in an arbitration proceeding. To opt out, you must send notice to LG no later than 30 calendar days from the date of the first consumer purchaser’s purchase of the product by either: (i) sending an e-mail to optout@lge.com, with the subject line: “Arbitration Opt Out” or (ii) calling 1- 800-980-2973. You must include in the opt out e-mail or provide by telephone: (a) your name and address; (b) the date on which the product was purchased; (c) the product model name or model number; and (d) the serial number (the serial number can be found (i) on the product; or (ii) online by accessing [https:// www.lg.com/us/support/repair-service/schedule-repair-continued](https://www.lg.com/us/support/repair-service/schedule-repair-continued) and clicking on “Find My Model & Serial Number”).

You may only opt out of the dispute resolution procedure in the manner described above (that is, by e-mail or telephone); no other form of notice will be effective to opt out of this dispute resolution procedure. Opting out of this dispute resolution procedure will not affect the coverage of the Limited Warranty in any way, and you will continue to enjoy the full benefits of the Limited Warranty. If you keep this product and do not opt out, then you accept all terms and conditions of the arbitration provision described above.

The following circumstances are not covered under the warranty:

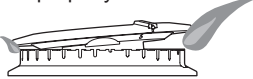
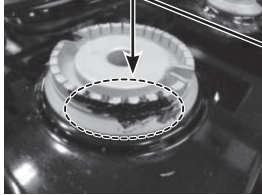
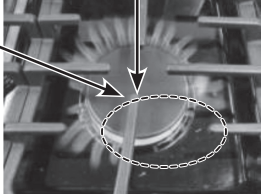
Problem	Cause	Prevention
<ul style="list-style-type: none"> Burners do not light 	<p>Clogged or dirty burner ports or electrodes will not allow the burner to operate properly</p> <p>Small burner</p>  <p>Large burner</p> 	<ul style="list-style-type: none"> Check and clean the gas electrode.
<ul style="list-style-type: none"> Uneven flame 	<p>1. Improper burner cap installation</p> <p>Burner cap is properly seated.</p>  <p>Burner cap is NOT properly seated.</p>  <p>2. Burner ports clogged by food residue</p> <p>Ports blocked by dirt</p>  <p>Flames uneven</p> 	<ul style="list-style-type: none"> Check installation of burner head and cap Hardened residue should be removed using a toothbrush.

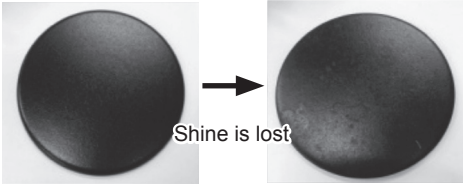
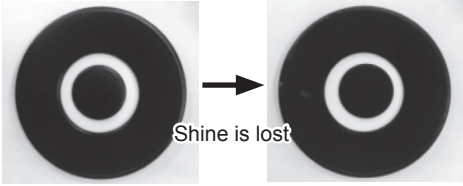
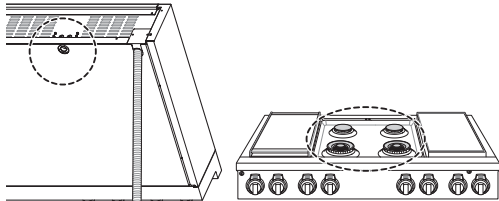
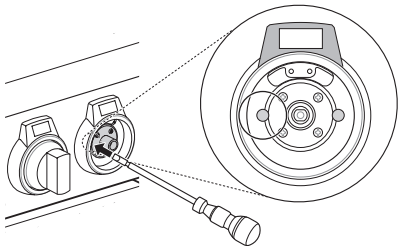
Problem	Cause	Prevention
<ul style="list-style-type: none"> • Burner cap is dull or has changed color 	<ol style="list-style-type: none"> 1. Scratching 2. Use of detergent or abrasive cleansers <p>Small burner cap</p>  <p>Large burner cap</p> 	<ul style="list-style-type: none"> • Do not use steel wool or abrasive cleansers to clean. • To remove burnt-on food, soak the burner heads in hot water for 20–30 minutes. (Do not use detergent)
<ul style="list-style-type: none"> • Unit has no power 	<ol style="list-style-type: none"> 1. House power turned off (power supply) 2. Tripped breaker 3. The power cord is not installed properly. 	<ul style="list-style-type: none"> • Check power at main board before calling for service. • Match power cord type and outlet type • Properly install the power cord
<ul style="list-style-type: none"> • Flames too big on converted cooktop (NP → LP) 	<p>The installer missed part of the conversion. (Check 2 parts: regulator, cooktop valve).</p>  <p>Pressure Regulator cooktop valve</p>	<ul style="list-style-type: none"> • Check with installer first • Refer to installation manual
<ul style="list-style-type: none"> • Flame is too small or too large 	<ol style="list-style-type: none"> 1. Variable gas pressure 2. Installer did not check  <p>Center adjustment screw</p>	<ul style="list-style-type: none"> • Check with installer first

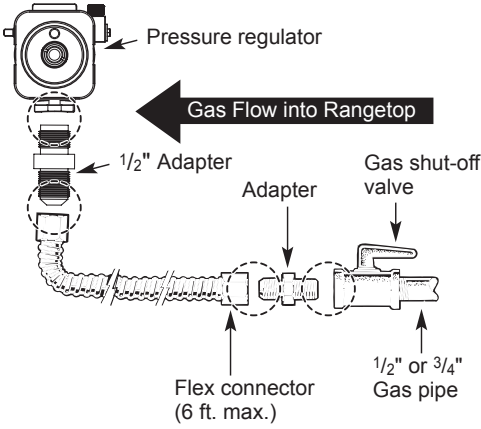
Problem	Cause	Prevention
<ul style="list-style-type: none"> Gas smell 	<p>Improper connection</p> <p>Flexible Connector Hookup</p>  <p>The diagram illustrates a gas line assembly. At the top is a pressure regulator. Below it is a 1/2" adapter. A flexible connector, labeled 'Flex connector (6 ft. max.)', is connected to the adapter. This flex connector is joined to another adapter, which is then connected to a gas shut-off valve. The shut-off valve is attached to a 1/2" or 3/4" gas pipe. A large arrow points from the gas pipe towards the rangetop, labeled 'Gas Flow into Rangetop'.</p>	<ul style="list-style-type: none"> Check with installer first

The cost of repair or replacement under these excluded circumstances shall be borne by You.

TO OBTAIN WARRANTY SERVICE AND ADDITIONAL INFORMATION

Call 1-855-790-6655 and select the appropriate option from the menu.

Or visit our website at www.sksappliances.com

Or by mail: **LG** Customer Service P.O. Box 240007 Huntsville, AL 35813 ATTN: CIC

SKS

Customer Information Center

For inquiries or comments, call:

1-855-790-6655 USA

1-888-289-2802 CANADA

Centro de Información al Cliente

Para consultas o comentarios, llame por teléfono:

1-855-790-6655 EE.UU.

1-888-289-2802 CANADÁ

Centre de Service à la Clientèle

Pour des questions ou des commentaires, ou appelez :

1-855-790-6655 ÉTATS-UNIS

1-888-289-2802 CANADA