

# PROF30SOEX

PROFESSIONAL SERIES  
30" CONVECTION SPEED OVEN



Bring Italian design and precision into your kitchen with the Bertazzoni speed oven, engineered to install proud or flush in any type of kitchen cabinet.

Enjoy the flexibility of baking, broiling and microwaving in a single oven. Use each cooking mode independently or in combination for amazing results.

Prepare meals in up to half the time with the convection microwave mode, without compromising quality, aroma and taste.

Manage cooking modes, temperature and time with the highly intuitive touch-through-glass user interface.

Enjoy the convenience of soft-motion balanced doors and no-fingerprint stainless steel.

Designed with pride by Bertazzoni in Italy.

Industry leading 2 years parts and labor warranty.

## PRODUCT FEATURES

Oven type	Combination electric convection and broiler with microwave
Power rating (Rating at 240V)	Broiler: 1500 W Convection: 1600 W
Microwave power rating	1000 W
Microwave power levels	200/400/600/800/1000
Oven Volume	1.34 cu.ft.
Convection System	1 Fan
User interface	Touch LED display
Auto cooking modes	Yes
Cooking modes	Broil, Convection, Convection broil, Convection microwave, Microwave, Microwave broil, Pizza
Special features	Defrost by time, Defrost by weight, Light, Popcorn, Recipes, Timer
Shelf levels	2
Door hinges	Soft-motion
Included accessories	1 glass turntable + 1 roasting trivet

## TECHNICAL SPECIFICATIONS

Electrical supply	240 V 60 HZ - 3850 W 16 Amp dedicated circuit
Power connection	Metal conduit with 71" power cord
Certification	CETLUS
Warranty	2 years parts & labor
Packaging dimensions and weight	W 33 1/2" H 21 5/8" D 26 3/8" 100.3 lbs

# PROF30SOEX

PROFESSIONAL SERIES  
30" CONVECTION SPEED OVEN



## PRODUCT DIMENSIONS

SIDE VIEW

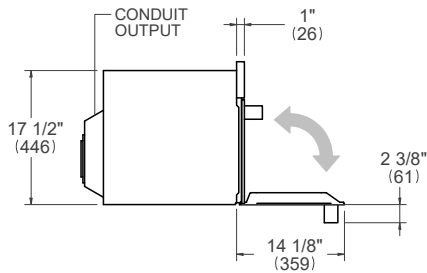

FRONT VIEW

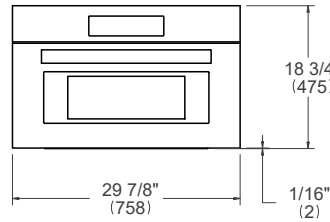

TOP VIEW

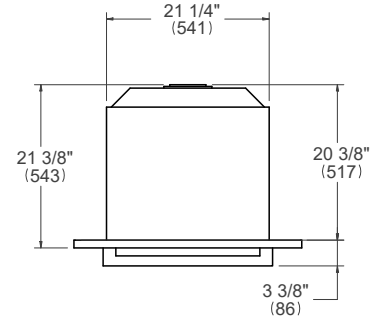

## ELECTRICAL CONNECTION

FRONT VIEW

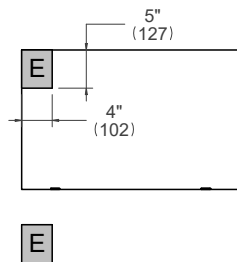

For single ovens installed into a wall cabinet, the electrical junction box may be located above, below to the left or right of the unit within reach of the power cord. Placement within the opening may require additional cabinet depth.

## INSTALLATION REQUIREMENTS

Minimum suggested load on cabinet base board is 110 lb (50 kg)

## CUTOUT DIMENSIONS

TOP VIEW

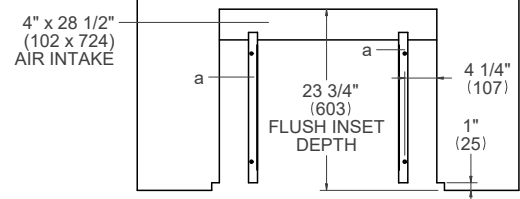

SIDE VIEW

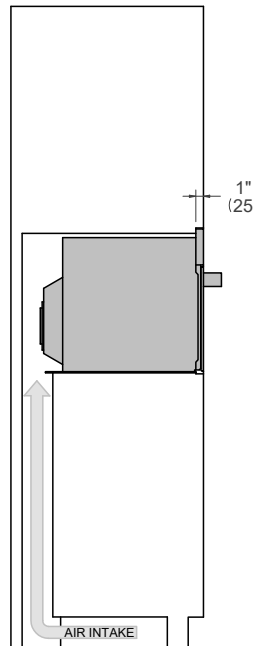

FRONT VIEW

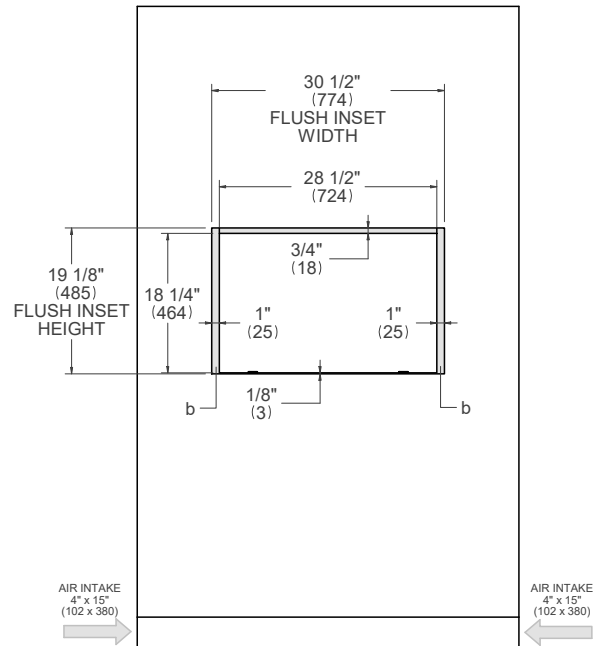

- (a) Spacers – Included with appliance
- (b) Visible Area – Match finish to outside cabinet panels

For installation of multiple products in combination, refer to the Design Guide at [us.bertazzoni.com](http://us.bertazzoni.com) or [ca.bertazzoni.com](http://ca.bertazzoni.com)