

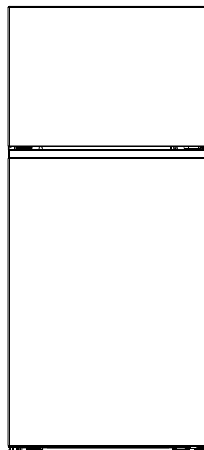

## 18 cu. ft. Top-Freezer Refrigerator

User Manual



### Models:

FF18SS	LRF182SS
FF18W	LRF181W
FF18SSIM	LRF182SSIM
FF18WIM	LRF181WIM

**BEFORE USE, PLEASE READ AND FOLLOW ALL SAFETY RULES AND OPERATING INSTRUCTIONS**

Write Model and Serial Numbers here:

Model \_\_\_\_\_

Serial No. \_\_\_\_\_

**Felix Storch, Inc.**  
An ISO 9001:2015 registered company  
770 Garrison Ave  
Bronx, New York 10474  
[www.summitappliance.com](http://www.summitappliance.com)

## **Welcome,**

Congratulations on your purchase of a new SUMMIT Refrigerator!

To get the most from your refrigerator, please read this user manual thoroughly before installation and use. It contains important safety information, detailed operating instructions, and helpful tips for optimal performance.

Keep this manual in a convenient location and provide it to any future owners.

Thank you for choosing SUMMIT.

## **Table of Contents**

<b>Important Safety Instructions.....</b>	<b>3</b>
<b>Refrigerator Overview.....</b>	<b>6</b>
<b>Installing Your New Appliance.....</b>	<b>7</b>
<b>Display Controls.....</b>	<b>11</b>
<b>Using Your Appliance.....</b>	<b>12</b>
<b>Cleaning and Care.....</b>	<b>13</b>
<b>Helpful Hints and Tips.....</b>	<b>14</b>
<b>Troubleshooting.....</b>	<b>15</b>
<b>Disposal of the Appliance.....</b>	<b>17</b>
<b>Limited Warranty.....</b>	<b>20</b>

## Important Safety Instructions

Read and follow all safety messages. Save these instructions.



This safety alert symbol will help you understand situations and hazards that may cause injury or death.

### **! WARNING**

The **WARNING** alert means a potentially hazardous situation. Serious injury or death may occur if not avoided.

### **! DANGER**

The **DANGER** alert means an imminently hazardous situation. Serious injury or death may occur if not avoided.

### **! CAUTION**

The **CAUTION** alert means a potentially hazardous situation. Moderate or minor injury may occur if not avoided.

### **! WARNING**

1. Ensure that everyone using this appliance is familiar with its operations and safety features. This appliance is not intended for people (including children) with reduced physical, sensory or mental capabilities, unless supervised or properly instructed.

2. This appliance is intended for residential households and similar applications.

3. Keep explosive and flammable substances away from the unit. Do not store these materials in the refrigerator.

4. Disconnect power before servicing or installing an ice maker.

5. Do not use thinners, car detergent, Clorox, ethereal oil, abrasive cleansers or organic solvents such as benzene for cleaning the appliance (including exterior and interior accessories). They may damage the surface of the appliance and may cause a fire.

6. Remove the old unit with 2 or more people before installing the new unit.

7. Connect to potable water supply only.

8. Do not use mechanical devices or other means to accelerate the defrosting process other than those recommended by the manufacturer.

9. Do not damage the refrigerant circuit.

10. Do not use electrical appliances inside the food storage compartments of the appliance, unless they are of the type recommended by the manufacturer.

11. The power cord of the appliance is equipped with a three-prong grounding plug for your protection against electrical shock hazards. It must be plugged directly into a properly grounded 3-prong receptacle. The receptacle must be installed in accordance with local codes and ordinances. Do not use an extension cord or adapter plug.

If the supply cord is damaged, it must be replaced by the manufacturer, its service agent or similarly qualified persons in order to avoid a hazard.

12. Keep the ventilation openings in the appliance enclosure or built-in structure clear from any obstructions.

13. Risk of child entrapment. Please check your appliance interior prior to disposal. Before you throw away your old appliance:

- Take off the doors

- Leave the shelves in place so that children may not easily climb inside

 **DANGER**

To reduce the risk associated with using an electric appliance, please follow the electrical safety instructions below..

1. The appliance requires single phase 115V/60Hz power supply. It has a power cord that has a 3-prong grounding plug that minimizes the possibility of electrical shock. This appliance must be grounded. Do not remove the grounding prong or modify the power plug.
2. The unit should be plugged into a dedicated electrical outlet that meets all current standards and requirements. Do not plug anything else into the same outlet and ensure the appliance is the only thing plugged into the entire circuit. It should have its own dedicated breaker. Otherwise, this may overload the circuit and cause a fire.
3. Do not modify the power plug. The power plug must be accessible when the appliance is installed.
4. The appliance should not be turned off with a switch or other device.
5. Ensure that the power plug is not pinched or damaged, as this may result in a short circuit, electric shock, overheating, or even a fire.
6. Do not insert the power plug if the socket is loose, there is a risk of electric shock or fire.
7. Switch off the appliance and disconnect it from the main power before you clean or move it.
8. Never unplug the appliance by pulling on the electrical cord. Always grip the plug firmly and pull straight out from the socket to prevent damaging the power cord.
9. Do not operate the appliance without the cover over the interior lighting.
10. All electrical components must be repaired or replaced by a qualified electrician or authorized service personnel. Use only manufacturer-approved replacement parts.
11. To avoid eye injury, do not look direct into the LED light located in the refrigerator compartment. If it is not functioning correctly, consult a qualified, registered electrician or replace it in accordance with the Cleaning and Care section.
12. The refrigerant isobutene (R600a) is contained within the refrigerant circuit of the appliance. During transportation and installation of the appliance, ensure that none of the components of the refrigerant circuit become damaged. The refrigerant (R600a) is flammable.

 **CAUTION**

1. Don't store products which contain flammable propellants (e.g. spray cans) or explosive substances in the appliances.
2. Avoid open flames (candles, lamps etc.) and other sources of ignition.
3. Ensure the room where the appliance is installed is well ventilated.
4. Unpack and check through the appliance. Should any damage be evident, don't plug in the appliance but contact the shop immediately from which you purchased it. Keep all packing materials in this case.
5. We recommend that you wait for 4 hours before connecting the appliance to allow the refrigerant to flow back into the compressor.

### **General Safety and Daily Use**

- It is important to use your appliance safely. We recommend that you follow the guidelines below.
- We recommend that you keep this users manual with the appliance for future reference.
- This appliance is intended to be used in households and similar applications such as:
  - Staff kitchen-areas in shops, offices and other working environments
  - Clients in hotels, motels and other residential environment
  - Bed and breakfast environments
  - Catering and similar non-retail applications
- Children should be supervised to ensure that they do not play with the appliance and given instruction regarding proper use of the appliance.
- Store any food in accordance with the storage instructions from the manufacturer.
- Don't try to repair the appliance yourself. It is dangerous to alter the specifications or modify this product in any way. Any damage to the power cord may cause a short circuit, fire or electric shock.
- Don't place too much food directly against the air outlet on the rear wall of both the refrigerator and freezer compartment, as it may affect sufficient air circulation.
- Don't place hot items near the plastic components of this appliance.
- Frozen food should not be refrozen once it has been thawed out.
- Don't store bottled or canned drinks (especially carbonated drinks) in the freezer compartment. Bottles and cans may explode.
- Use caution consuming popsicles or ice cubes straight from the freezer as this can cause freezer burn to the mouth and lips.

### **Important Safety Information for Children and Persons with Limited Capabilities**

- Keep all packaging away from children to avoid risk of suffocation.
- Protect children from being scalded by touching the compressor at the rear bottom of appliance.
- Don't place items on top of the appliance as this could cause injury should they fall off.
- Never allow children to play with the appliance by hanging or standing over or on the doors, racks, shelves and drawers etc.

## Refrigerator Overview

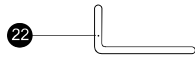
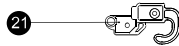
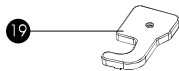
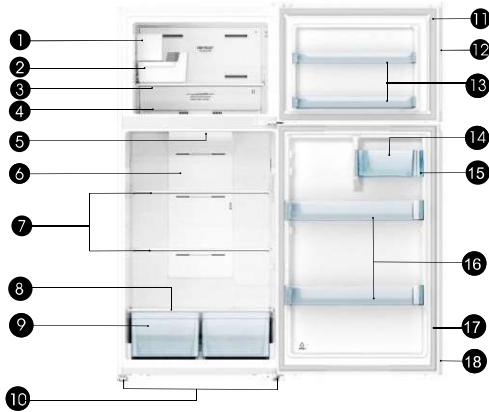

- 1 Automatic Icemaker (Optional)
- 2 Ice Container (Optional)
- 3 Glass Shelf
- 4 Freezer Air Duct
- 5 LED Light
- 6 Fridge Air Duct
- 7 Glass shelves
- 8 Crisper Cover
- 9 Crisper Drawers
- 10 Adjustable bottom feet

- 11 Freezer Door Gasket
- 12 Freezer Door
- 13 Freezer Door Bins
- 14 Dairy Bin Cover
- 15 Dairy Bin
- 16 Gallon Door Bins
- 17 Fridge Door Gasket
- 18 Fridge Door

### Package Contents

- 19 Left hinge cover
- 20 Stopper block (x2)

### Spare parts for reversing the door

- 21 Door stopper (x2)
- 22 Allen wrench

### NOTE

- Due to ongoing product improvements, your refrigerator may differ slightly from the illustrations in this manual. However, the functions and operating procedures remain the same.
- For optimal energy efficiency, ensure that all shelves, drawers, and baskets are placed in their original positions as shown in the illustration above.

## Installing Your New Appliance

Before using the appliance for the first time, you should be informed of the following tips.

### **Warning!**

For proper installation, this refrigerator must be placed on a level surface of hard material that is the same height as the rest of the flooring. This surface should be strong enough to support a fully loaded refrigerator. The rollers, which are not castors, should be only used for forward or backward movement. Moving the refrigerator sideways may damage your floor and the rollers.

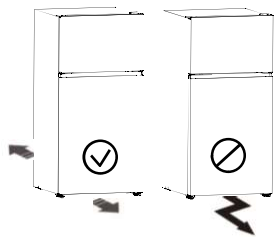

### **Warning!** Ventilating the Appliance

In order to improve efficiency of the cooling system and save energy, it is necessary to maintain good ventilation around the appliance for the dissipation of heat. For this reason, sufficient clear space should be available around the refrigerator.

#### Suggestion

It is recommended to maintain the following clearances for proper ventilation and door operation:

- 3 inches (75 mm) behind
- 3.9 inches (100 mm) on each side
- 3.9 inches (100 mm) on top
- Enough space in front to open the doors to 125°

A	58.1 "(1476mm)
B	30.7 "(779mm)
C	29.5 "(750mm)
D	47.3 "(1201mm)

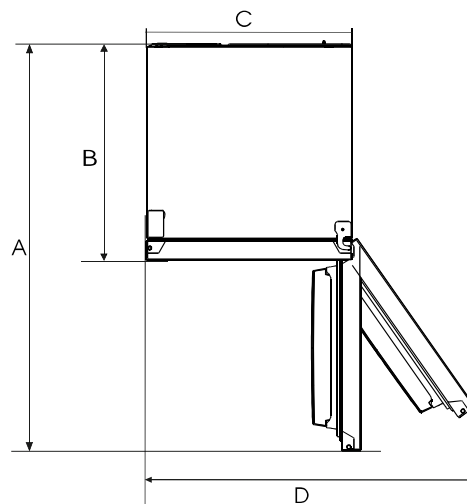
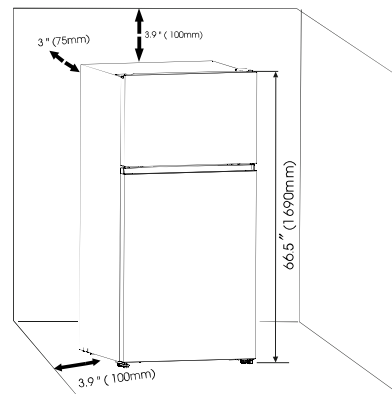

#### Note:



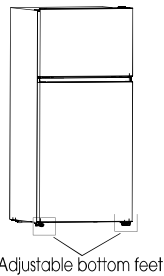
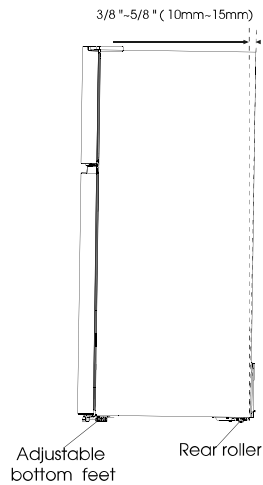

- This appliance performs well with ambient temperature between 55 °F – 110 °F (12.8 °C – 43.3 °C). The appliance may not work properly if left at a temperature above or below the indicated range.
- Stand your appliance in a dry place to avoid high moisture.
- Keep the appliance out of direct sunlight, rain or frost. Stand the appliance away from heat sources such as stoves, fires or heaters.

### Leveling the Appliance

- To ensure proper leveling and air circulation at the lower rear of the appliance, adjust the bottom feet by hand.
- For the doors to close automatically, tilt the appliance slightly backward—about 3/8 to 5/8 inches (10 – 15 mm) from front to back.

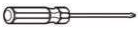
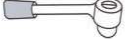

### Tools you may need

Not provided		
	Phillips Screwdriver	Socket Wrench (5/16", 8mm)
		
Provided		
	Allen Wrench (5/32", 4mm)	

### Reversing the Fridge Door

If needed, the door swing can be changed from right (factory default) to left to suit your installation needs.

#### **Warning!**

When reversing the door, ensure that the plug is removed from the mains socket.

#### Note:

If necessary, tilt the unit backward to access the base. Be sure to rest the appliance on soft surface to prevent any damage to the backboard. Follow the steps outlined below to reverse the door.

Keep all removed parts—especially the original hinges—safely stored in case you wish to reverse the door orientation again in the future.

1. Stand the unit upright. Remove all racks from the refrigerator door, then close the door.

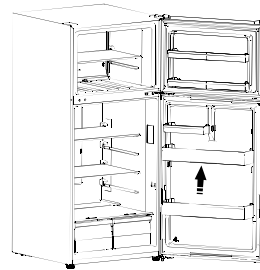

2. Close the unit's doors and remove the screws to detach the upper hinge cover (E) on the top right side of unit. Remove the three flange screws (F) with a socket wrench to detach the upper hinge. Set the screws and hinge cover aside.

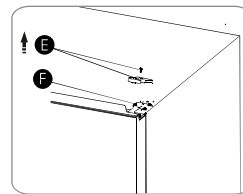

3. Hold the door firmly when removing the upper hinge.

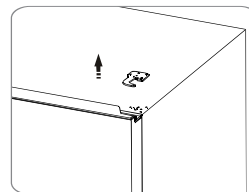



4. Open the freezer door to a 90° angle or more. Then lift it upward with both hands to remove it from the unit.

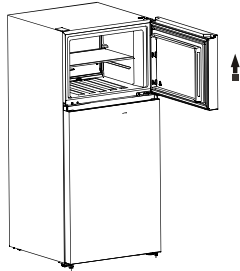

5. Detach the two screws (G) to remove the right stopper block (H) and door stopper (I). Install the provided left stopper block (K) and door stopper (J) on the left side. Reattach them using the same screws (G).

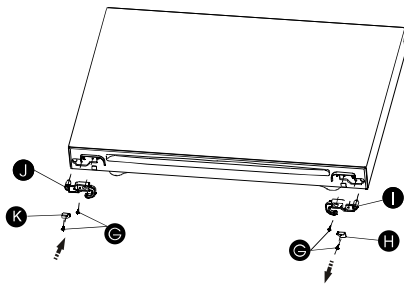

6. Open the refrigerator door. Using the provided 4 mm Allen wrench, remove the two screws (L). Then, use a Phillips screwdriver to remove screw (N) and take off the middle hinge (M). Set the hinge aside. Lift the refrigerator door upward to remove it from the lower hinge.

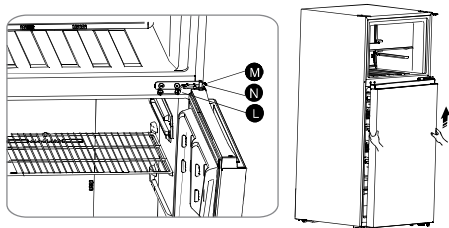

7. Lay the refrigerator door face up on a firm, smooth surface. Then, repeat the procedure from Step 5 to remove and reinstall the stopper components on the freezer door.

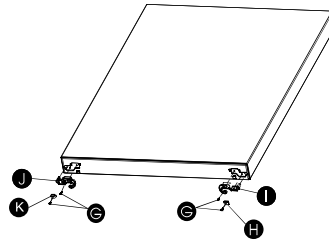

8. Reattach screw (N) into the outermost hole on the right side of the unit. Next, move the screw hole covers on the middle cover plate from the left side to the right side.

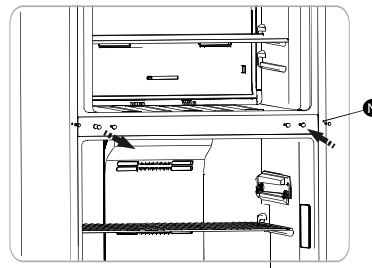

9. Lay the unit face-up on a firm, smooth surface. Unscrew and remove the bottom feet. Then, detach the lower hinge by removing the flange self-tapping screws. Relocate the lower hinge pin to the opposite side and secure it firmly in the new position.

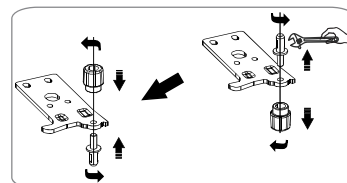
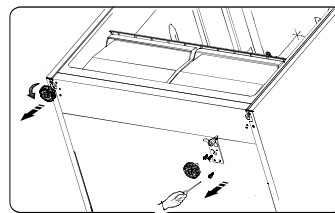

10. Attach the lower hinge to the left side using the flange self-tapping screws. Then, switch the feet to the opposite sides and screw them in place.

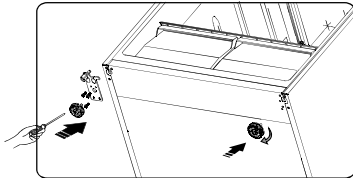

11. Stand the refrigerator upright and carefully sit the refrigerator door onto the lower hinge pin and hold it in position.

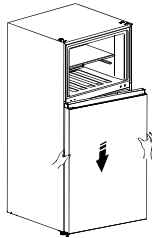

12. Turn the middle hinge 180°, insert the middle hinge axis into the hole in the upper left side of the refrigerator door and tighten the bolts.

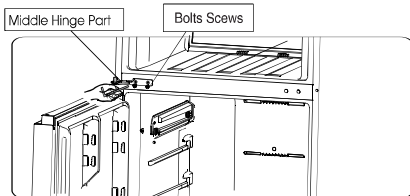

13. Position the freezer door onto the middle hinge by inserting it on the hinge pin. Ensure the door is leveled.

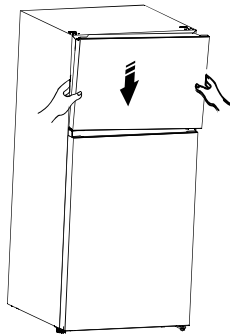

14. Flipping the Upper Hinge:  
 a. Use a wrench to remove the nut (1).  
 b. Remove the hinge axis (2).  
 c. Flip the hinge over.  
 d. Use the wrench to reinsert and align the hinge axis (4).  
 e. Use a wrench to secure the nut (5).



15. Locate the upper left hinge cover from the provided and fix it with screws.

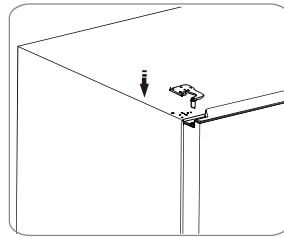

16. Adjust the upper hinge till the door seal is flat against the unit. Ensure there are no gaps.

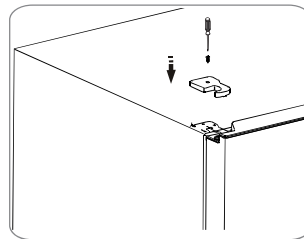

## Display Controls

### Review the recommended temperature settings before use.

Use the control panel to adjust the temperature for the refrigerator and freezer compartments. For typical use, set the temperature control to the middle position. Refer to the table below for recommended settings based on seasonal temperature variations.

#### Refrigerator Temperature Control

Press the **SETTING** Hold 5sec Standby button to adjust the temperature. Each press will cycle through the settings from 1 to 5. (1 is the warmest, and 5 is the coldest.)

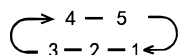

Temperature Setting Recommendation		
Seasonal Temperature	Freezer Compartment	Refrigeration Compartment
Summer (Above 89.6°F)	<p>Set towards the left</p>	<p>Set between 3~4</p>
Normal	<p>Set to the center</p>	<p>Set to middle position</p>
Winter (Below 53.6°F)	<p>Set towards the right</p>	<p>Set between 4~5</p>

#### Demo mode

Demo Mode is intended for in-store display only. In this mode, the lights and control panel work normally, but cooling is disabled.

To Activate:  
Press and hold the **SETTING** Hold 5sec Standby button for 5 seconds.

To Deactivate:  
Press and hold the **SETTING** Hold 5sec Standby button for 5 seconds. The unit will resume cooling.

#### Important!

Avoid overloading the refrigerator, as this may block the temperature sensor and interfere with proper operation.

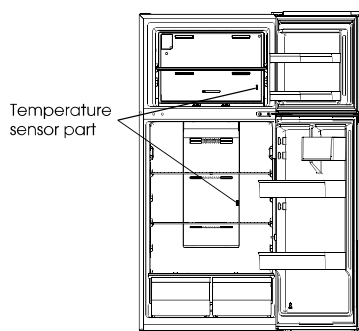

## Using your Appliance

This section explains how to use the main features of your appliance. We recommend reading it carefully before first use.

### 1. Refrigerator Compartment

The refrigerator compartment is ideal for storing fruits and vegetables. Always package foods properly to prevent moisture loss and absorption of unwanted odors.

#### **⚠ CAUTION**

Never close the refrigerator door while the shelves, crisper or telescopic slides are extended. It may damage both the components and the refrigerator.

#### Shelves and Bins

The refrigerator compartment includes shelf parts and door bins ideal for storing eggs, canned drinks, bottles, and packaged food.

- Shelves and racks can be repositioned to suit your storage needs.
- Avoid placing heavy items in the door racks.
- Always remove food before lifting a door bin vertically.

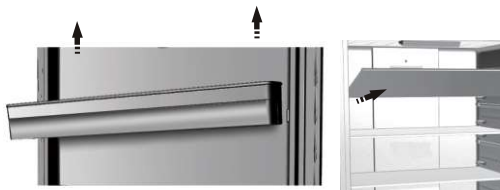

The drawer is best for storing fruits and vegetables. It can be removed for cleaning.

To remove the drawer:

1. Open the refrigerator door fully.
2. Pull the drawer out.
3. Tilt the front upward slightly and lift.

### Using the Freezer Compartment

The freezer compartment includes a glass shelf.

### 3. Automatic Ice Maker

*(Models with Ice Maker)*

The ice maker produces ice automatically and stores it in the ice bucket located inside the freezer.

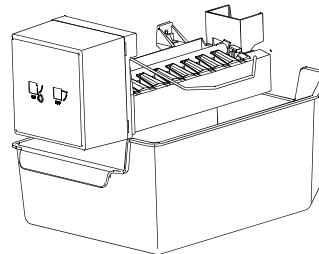

#### Note:

- Sounds from the ice maker while dispensing ice are normal.
- If ice isn't used for an extended period, it may clump. Empty and clean the bin if this happens.
- If you'll be away for a while or not using the ice maker, close the water valve to prevent leaks.
- Discard the first few batches of ice to ensure optimal quality.
- Do not store cans or sealed containers that may burst when frozen.

#### **⚠ CAUTION**

Do not allow children to touch the ice maker. Doing so may result in injury.

## Cleaning and Care

It is recommended the appliance (including the exterior and interior accessories) are cleaned at least once every two months.

### CAUTION

Switch the appliance off and disconnect it from the wall outlet before cleaning. Danger of electrical shock!

### Exterior Cleaning

To maintain good appearance of your appliance, clean the exterior regularly.

- Spray water onto a cleaning cloth instead of spraying directly on the surface of the appliance. This helps apply moisture evenly.
- Use a mild detergent to clean the doors, handles, and cabinet surfaces, then wipe dry with a soft cloth.

### CAUTION

- Do not use sharp tools—they can scratch the surface.
- Avoid cleaners like thinner, car detergent, bleach, essential oils, abrasives, or solvents such as benzene. These can damage the surface or even cause fire.

### Interior Cleaning

Clean the interior regularly—this is easiest when food supplies are low.

1. Use a mild solution of baking soda and water to wipe down the inside of the refrigerator and freezer compartments.
2. Rinse with warm water using a soft cloth or sponge.
3. Dry all surfaces and removable parts thoroughly before putting them back in place.

**NOTE:** Although this appliance automatically defrosts, a layer of frost may occur on the freezer compartments interior walls if the freezer door is opened frequently or kept open too long.

If the frost is too thick, choose a time when the freezer is nearly empty and proceed as follows:

1. Remove existing food and accessories baskets, unplug the appliance from the main power and leave the doors open. Ventilate the room thoroughly to accelerate the process.
2. When defrosting is completed, clean your freezer as described above..

### WARNING

Do not use sharp objects to remove frost from the freezer compartment. Only after the interior is completely dry should the appliance be switched back on and plugged back into the main socket.

### Door Gasket Cleaning

Keep the door gasket clean to prevent it from sticking or tearing. Use a mild detergent and warm water to wash the gasket, then rinse and dry it thoroughly. Sticky spills can cause the gasket to adhere to the cabinet and may damage it when opening the door.

### CAUTION

Only after the door seals are completely dry should the appliance be powered on.

### Replacing the LED Light

#### WARNING

The LED light must be replaced by a skilled or qualified person. If the LED light is damaged, follow the steps below:

1. Unplug your appliance.
2. Remove light cover by lifting it up and pulling it out.
3. Hold the LED light with one hand and pull it with the other hand while pressing the connector latch.
4. Replace LED light and snap it correctly in place and reattach the light cover.

## Helpful Hints and Tips

### Energy Saving Tips

To reduce energy consumption, follow these guidelines:

- Avoid keeping the doors open for long periods.
- Keep the appliance away from heat sources such as direct sunlight, ovens, or cooktops.
- Do not set the temperature lower than needed.
- Avoid placing warm food or uncovered liquids inside the appliance.
- Install the appliance in a well-ventilated, dry room. Refer to the Installing Your New Appliance section.
- Follow the recommended configuration for drawers, crisper, and shelves to maintain energy efficiency.

### Tips for Fresh Food Refrigeration

- Let hot food cool before placing it in the refrigerator or freezer.
- Cover or wrap foods, especially those with strong odors.
- Organize food to allow proper air circulation.

### Tips for Storing Specific Foods in the Refrigerator

- **Meat:** Wrap in cling film and place on the glass shelf above the vegetable drawer. Follow use-by dates.
- **Cooked food and cold dishes:** Cover and place on any shelf.
- **Fruits and vegetables:** Store in the crisper drawer.
- **Butter and cheese:** Wrap in airtight foil or plastic wrap.
- **Milk bottles:** Seal and place in the door racks.

### Tips for Freezing Food

- After initial installation or extended shutdown, set the appliance to its coldest temperature for at least 2 hours before adding food.
- Freeze food in small portions for faster freezing and easier defrosting.
- Use airtight wrapping such as aluminum foil or plastic wrap.
- Keep new food away from already frozen items to prevent temperature rise.
- Avoid consuming ice products (e.g., popsicles, ice cubes) immediately after removal, as they can cause frostbite.
- Label and date all frozen food packages.

### Tips for Storing Frozen Food

- Make sure frozen food was stored correctly by the retailer.
- Do not refreeze defrosted food, as it spoils quickly.
- Follow storage durations recommended by the food manufacturer.

### Switching Off Your Appliance

If you need to shut off the appliance for an extended period:

1. Remove all food.
2. Remove the power plug from the main socket.
3. Clean and dry the interior thoroughly.
4. Ensure that the doors are slightly open to allow air to circulate.

## Troubleshooting

If you experience a problem with your appliance or are concerned that the appliance is not functioning correctly, you can carry out some easy checks before calling for service, please see below.

**⚠ WARNING**

1. Don't try to repair the appliance yourself. If the problem persists after you have made the checks mentioned below, contact a qualified electrician, authorized service personnel, or the retailer where you purchased the product.

2. A child entrapment warning statement is included in either the operating instructions or in a use and care manual provided with each refrigerator.

Problem	Possible Cause & Solution
Appliance is not working correctly	Ensure the power cord is plugged into the power outlet.
	Check the fuse or circuit of your power supply, replace if necessary.
	The ambient temperature is too low. Try setting the appliance to a colder temperature to improve performance.
	It is normal for the freezer to stop running during the defrost cycle or shortly after the appliance is turned on. This pause helps protect the compressor.
Odors from the compartments	Clean the interior if necessary.
	Some food, containers, or packaging cause odors.
Noise from the appliance	<p>The following sounds are normal during operation:</p> <ul style="list-style-type: none"> <li>• Humming or buzzing from the compressor</li> <li>• Air movement noise from the fan motor in the freezer or other compartments</li> <li>• Gurgling sounds, similar to boiling water</li> <li>• Popping noises during automatic defrosting</li> <li>• Clicking sounds when the compressor starts or when dispensing water</li> <li>• Motor sounds when dispensing ice</li> </ul>
	<p>Unusual noises may be caused by the following and may require your attention:</p> <ul style="list-style-type: none"> <li>• The appliance is not level</li> <li>• The back of the appliance is touching the wall</li> <li>• Bottles or containers inside have tipped over or are rolling</li> </ul>

<p>The motor runs continuously</p>	<p>It is normal to frequently hear the motor running. It may operate more often under the following conditions:</p> <ul style="list-style-type: none"> <li>• The temperature setting is colder than necessary</li> <li>• A large amount of warm food has recently been placed inside</li> <li>• The ambient temperature is high</li> <li>• The doors are opened too frequently or left open for too long</li> <li>• The appliance has just been installed or restarted after being off for an extended period</li> </ul>
<p>A layer of frost occurs in the compartment</p>	<p>Check that the air outlets are not blocked by food and arrange items to allow proper airflow inside the appliance. Ensure the door is fully closed. To remove frost, refer to the Cleaning and Care section.</p>
<p>The temperature inside is too warm</p>	<p>The doors may have been left open too long or too frequently, held open by an obstruction, or the appliance may not have enough clearance at the sides, back, or top.</p>
<p>The temperature inside is too cold</p>	<p>Increase the temperature by following the Display Controls section.</p>
<p>Doors won't close properly</p>	<p>Check if the refrigerator is tilted slightly backward (10–15 mm) to help the doors close automatically.</p> <p>Ensure nothing inside is blocking the doors.</p>
<p>The light is not working</p>	<p>The LED light may be damaged. Refer to the Cleaning and Care chapter for instructions on replacing the LED light.</p> <p>The control system may have disabled the light because the door was left open too long. Close the door, then reopen it to reactivate the light.</p>
<p>Hear water bubbling in the refrigerator</p>	<p>This is normal. The bubbling sound comes from the refrigerant circulating through the appliance.</p>

If you have checked the information above and you still need help with your appliance, call our Customer Service facility at **800-932-4267** (Ext. **513**) between 9:00 AM and 5:00 PM ET or visit our website **summitappliance.com/support** at any time. We will do our best to answer your questions.

To order replacement parts, visit our website: **summitapplianceparts.com**



## Disposal of the Appliance

### DANGER

It is prohibited to dispose of this appliance as household waste.

#### Packaging materials

Packaging materials with the recycle symbol are recyclable. Dispose of the packaging into a suitable waste collection container to recycle it.

#### Before disposal of the appliance

1. Pull out the main plug from the main socket.
2. Cut off the power cord and discard with the main plug.

### WARNING

Potential Suffocation Hazard! Potential death or brain damage could occur. Remove doors to prevent potential suffocation.

1. To prevent potential suffocation hazard, remove your old refrigerators doors completely immediately. Leave shelves installed to help block children from climbing on or getting inside.
2. When disposing of the appliance do so only at an authorized waste disposal center. Do not expose to flame.

Refrigerators contain refrigerant and gases in the insulation. Refrigerant and gases must be disposed of professionally as they may cause eye injuries or ignition. Ensure that tubing of the refrigerant circuit is not damaged prior to proper disposal

Correct Disposal of this product	
	<p>This symbol on the product or in its packing indicates that this product may not be treated as household waste. Instead, it should be taken to the appropriate waste collection point for the recycling of electrical and electronic equipment. By ensuring this product is disposed of correctly, you will help prevent potential negative consequences for the environment and human health, which could otherwise be caused by the inappropriate waste handling of this product. For more detailed information about the recycling of this product, please contact your local council, your household waste disposal service, or the shop where you purchased the product.</p>

## **NOTES**

## **NOTES**

## LIMITED WARRANTY

### ONE-YEAR LIMITED WARRANTY

Within the 48 contiguous United States, for one year from the date of purchase, when this appliance is operated and maintained according to instructions attached to or furnished with the product, warrantor will pay for factory-specified parts and repair labor to correct defects in materials or workmanship. Service must be provided by a designated service company. Outside the 48 states, all parts are warranted for one year from manufacturing defects. Plastic parts, shelves and cabinets are warranted to be manufactured to commercially acceptable standards, and are not covered from damage during handling or breakage.

### 5-YEARS COMPRESSOR WARRANTY

1. The compressor is covered for 5 years.
2. Replacement does not include labor.

### **ITEMS WARRANTOR WILL NOT PAY FOR:**

1. Service calls to correct the installation of your appliance, to instruct you how to use your appliance, to replace or repair fuses or to correct wiring or plumbing.
2. Service calls to repair or replace appliance light bulbs or broken shelves. Consumable parts (such as filters) are excluded from warranty coverage.
3. Damage resulting from accident, alteration, misuse, abuse, fire, flood, acts of God, improper installation, installation not in accordance with electrical or plumbing codes, or use of products not approved by warrantor.
4. Replacement parts or repair labor costs for units operated outside the United States.
5. Repairs to parts or systems resulting from unauthorized modifications made to the appliance.
6. Expenses for travel and transportation for product service in remote locations.
7. The removal and reinstallation of your appliance if it is installed in an inaccessible location or is not installed in accordance with published installation instructions.

### DISCLAIMER OF IMPLIED WARRANTIES – LIMITATION OF REMEDIES

CUSTOMER'S SOLE AND EXCLUSIVE REMEDY UNDER THIS LIMITED WARRANTY SHALL BE PRODUCT REPAIR AS PROVIDED HEREIN. IMPLIED WARRANTIES, INCLUDING WARRANTIES OF MERCHANTABILITY OR FITNESS FOR A PARTICULAR PURPOSE, ARE LIMITED TO ONE YEAR. WARRANTOR SHALL NOT BE LIABLE FOR INCIDENTAL OR CONSEQUENTIAL DAMAGES. SOME STATES DO NOT ALLOW THE EXCLUSION OR LIMITATION OF INCIDENTAL OR CONSEQUENTIAL DAMAGES, OR LIMITATIONS ON THE DURATION OF IMPLIED WARRANTIES OF MERCHANTABILITY OR FITNESS, SO THESE EXCLUSIONS OR LIMITATIONS MAY NOT APPLY TO YOU. THIS WARRANTY GIVES YOU SPECIFIC LEGAL RIGHTS AND YOU MAY ALSO HAVE OTHER RIGHTS, WHICH VARY FROM STATE TO STATE.

### CALIFORNIA CARB/SNAP DISCLOSURE

**This product uses eco-friendly hydrocarbon refrigerant and fully complies with California CARB regulations.**

However, we are required by California Law to provide the following disclosure statement in every product sold in California.

*"This equipment is prohibited from use in California with any refrigerants on the 'List of Prohibited Substances' for that specific end-use, in accordance with California Code of Regulations, title 17, section 95374. This disclosure statement has been reviewed and approved by Felix Storch, Inc. and Felix Storch, Inc. attests, under penalty of perjury, that these statements are true and accurate."*

This product does **not** use any refrigerants on the 'List of Prohibited Substances'"



**WARNING: This product can expose you to chemicals including Nickel (Metallic) which is known to the State of California to cause cancer.**

For more information go to [www.P65Warnings.ca.gov](http://www.P65Warnings.ca.gov)

Note: Nickel is a component in all stainless steel and some other metallic compositions

**FELIX STORCH, INC.**  
An ISO 9001:2008 registered company  
770 Garrison Avenue  
Bronx, NY 10474  
Phone: (718) 893-3900  
Fax: (844) 478-8799

[www.summitappliance.com](http://www.summitappliance.com)

# SUMMIT

For parts and accessory ordering,  
troubleshooting and helpful hints, visit:  
[www.summitappliance.com/support](http://www.summitappliance.com/support)