

### SEPTH18-348

Halogen lights. This model is not available with heat lamps. Shown with optional duct cover (sold separately). Optional duct covers are available in standard and custom sizes.

#### Dimensional Information

Width	48.0
Depth	24.0
Height	18.0
CFM @ 0.0" SP	900.0
Sones	6.3
Amps	5.9
# Lights	3.0

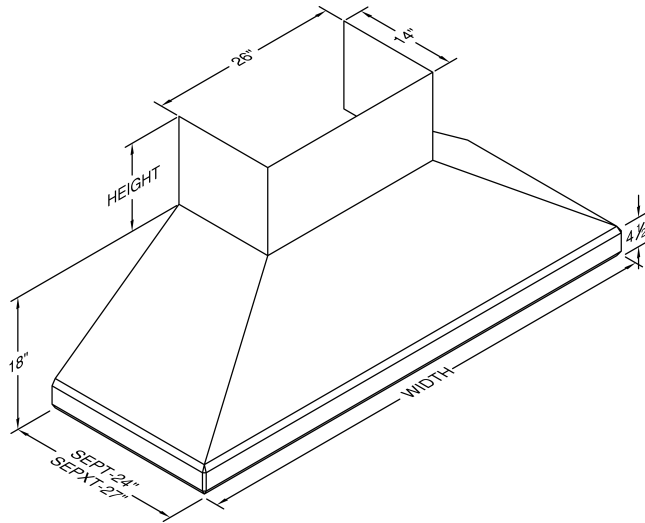

#### Connection Diagram

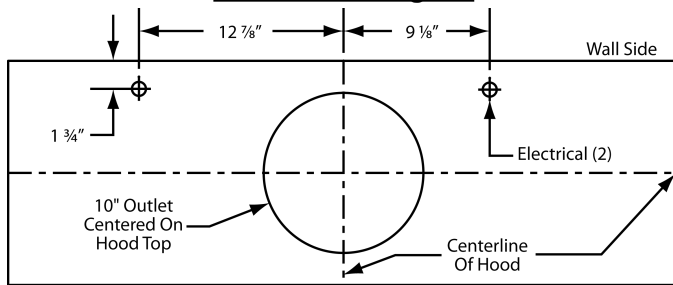

900 CFM B200 Dual B100 Single Blower (Top View)

#### Recommended Mounting Height\*

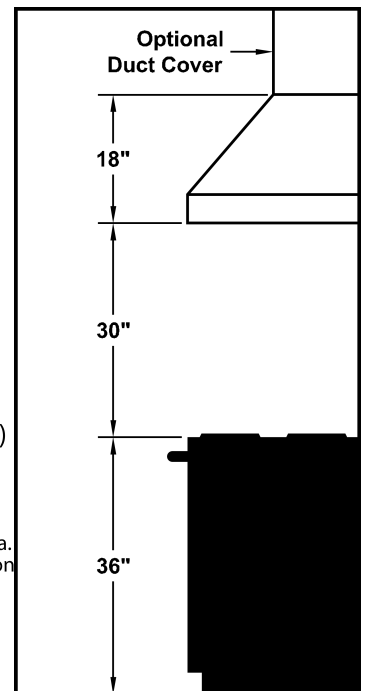

\*Exceeding recommended mounting height may compromise performance.

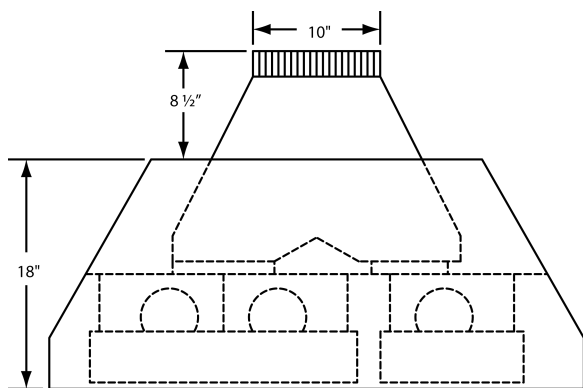

VP563 Standard Transition Installed (Front View)

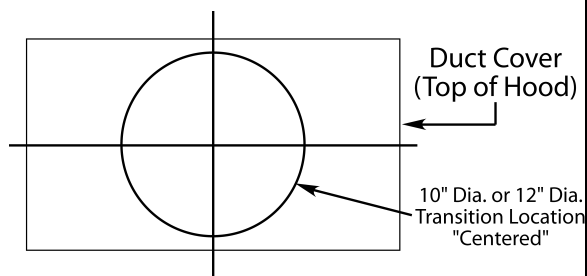

The transition shown (VP562) is installed in the hood at the factory as a standard item. It will be located in the exact center of the duct cover (left to right front to rear).

#### Electrical/Mechanical Specifications For Blower Unit

Model	Volts	Amps*	Hz	RPM	CFM SP@0.0"	Equivalent CFM	CFM SP@0.1"	CFM SP@0.2"	CFM SP@0.3"	Minimum Round Duct Size	Sones#
B200 Dual B100 Single	115.0	4.4	60.0	1550.0	900.0	1350.0	804.0	725.0	655.0	10" (79 sq. in.)	6.3

+ This model is equipped with halogen lighting: (3 lights: 42" - 53", 4 lights: 54" - 66").

\$ Because the Magic Lung® blower uses centrifugal filtration rather than conventional baffle or mesh filters, the Magic Lung® blower can handle cooking equipment with higher cubic feet per minute (CFM) requirements and can deliver equivalent CFM much more efficiently than other filtration systems. When comparing the Magic Lung® with other blower units made by other manufacturers, use the "Equivalent CFM".

# Ratings in accordance with the Standard Test Code by the Energy Systems Laboratory of the Texas Engineering Experiment Station.