









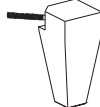

ASSEMBLY INSTRUCTIONS INSTRUCCIONES

B1200-1 DRESSER B1200-1 TOCADOR

PARTS LIST:				HARDWARE LIST:				
No.	OUTLOOK	DESCRIPTION	QT.	No.	OUTLOOK	DESCRIPTION	SIZE	QT.
1		DRESSER	1	A		HEX NUT	Ø5/16" x 1/2"	4
				B		LOCK WASHER	Ø5/16"	4
				C		FLAT WASHER	Ø5/16"	4
				D		HEX WRENCH	Ø5/16"	1
2		LEG	4	ANTI-TIPPING HARDWARE LIST:				
3		SUPPORT LEG	1	E		BRACKET	1/2" x 1"L	2
				F		TIE WRAP	#6 x 11-3/8"L	1
				G		LONG SCREW	#8 x 2"L	1
				H		SHORT SCREW	#8 x 5/8"L	1

STEP 1

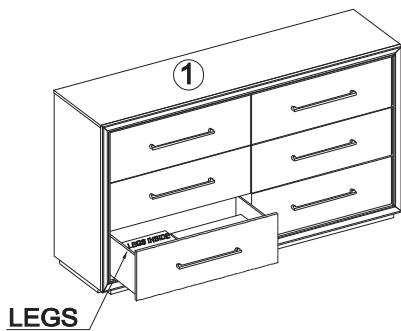

STEP 2

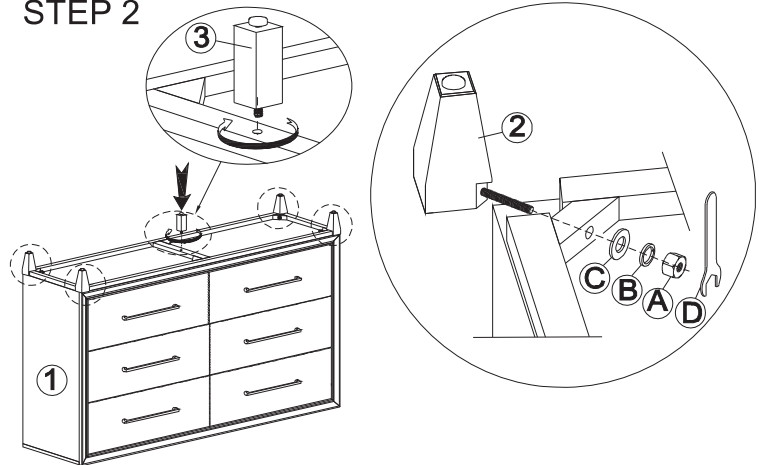

STEP 3

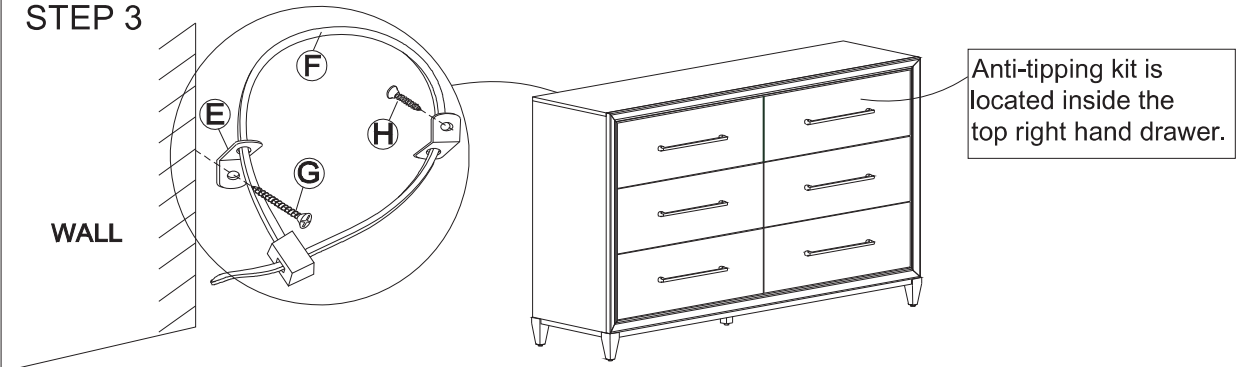

THE HARDWARE IS LOCATED
IN THE PACKING ITEMS.

NOTE:
DURING ASSEMBLY DO NOT FULLY
TIGHTEN ANY HARDWARE UNTIL THE
COMPLETE UNIT HAS BEEN ASSEMBLED.