



5 SERIES 48"W. GAS OPEN BURNER RANGE

Viking 5 Series – VGIC

COMMERCIAL-TYPE COOKING POWER

- **EXCLUSIVE** – Stainless steel open burners with porcelain/cast iron caps provide restaurant caliber performance
 - All burners are 15,000 BTUs
- **EXCLUSIVE** – VariSimmer™ Setting for all burners
- **EXCLUSIVE** – all burners equipped with SureSpark™ Ignition System for consistent and reliable ignition
 - Automatic re-ignition; surface burners light at any position on the knob and re-light if extinguished, even on lowest setting
- Black Chrome™ knobs shipped standard
- **EXCLUSIVE** – combination of single 30,000 BTU U-shaped burner and infrared broiler with SureSpark ignition system
- Gourmet-Glo™ Infrared Broiler provides intense searing heat for broiling applications (right oven only)
- Large-capacity ovens with six rack positions (see specifications for oven interior dimensions)
 - Right oven has three racks
 - Left oven has two racks
- Six functions – natural airflow bake, convection bake, infrared broil, convection infrared broil, convection dehydrate, and convection defrost
- All convection modes utilize the ProFlow™ Convection Air Baffle, which is specifically designed to ensure balanced airflow for even heat distribution
- Convection fan switch conveniently located on control panel
- Halogen oven lights for excellent visibility throughout the oven cavity



VGIC54828B

EASY OPERATION AND CLEANUP

- Removable porcelain burner bowls provide easy clean-up
- Burner caps are easily removable for quick cleaning
- Heavy-duty, porcelainized, cast-iron removable surface grates provide continuous front-to-rear, left-to-right surface for easy movement of large pots

MODEL NUMBERS

- VGIC54828B – 48"W. Gas Range; eight burners

ACCESSORIES

- BG8548SS – 8"H. backguard for 48" range
- HS24548SS – high shelf for 48" range
- P24CSTSS – countertop side trim (2 pieces)
- P48CRTSS – countertop rear trim for 48" range
- P48CBF4SS – curb base and custom curb base front for 48" range
- LPKPDR – LP/Propane Conversion Kit

COLOR FINISHES

- Stainless Steel (SS) and White (WH)



- Available in 14 exclusive color finishes Alluvial Blue (AB), Arctic Gray (AG), Black Forest Green (BF), Bywater Blue (BW), Cast Black (CS), Cypress Green (CY), Damascus Gray (DG), Frost White, (FW) Kalamata Red (KA), Pacific Gray (PG), Reduction Red (RE), Slate Blue (SB), San Marzano Red (SM), Vanilla Cream (VC)



WARRANTY

- 2-year full – complete product
- 90-day full – cosmetic parts such as glass, painted items and decorative items
- 5-year limited – gas burners



5 SERIES 48"W. GAS OPEN BURNER RANGE

Viking 5 Series – VGIC

GAS 48"W. OPEN BURNER RANGE	
DESCRIPTION	VGIC54828B
Overall Width	47-7/8" (121.6 cm)
Overall Height	To top of side trim - 35-7/8" (91.1 cm) min. 37" (94.0 cm) max. Legs adjust - 1-1/8" (2.9 cm)
Overall Depth from Rear*	To end of side panel - 24-5/16" (61.8 cm) To front of door - 25-3/4" (65.4 cm) To end of landing ledge - 28-1/16" (71.2 cm) To end of door handle - 28-11/16" (72.9 cm) *Add 3/4" to overall depth for ranges with backguards installed against a combustible wall.
Additions to Base Height	To top of island trim - add 1" (2.5 cm) To top of backguard - add 8" (20.3 cm) To top of high shelf - add 23-1/2" (59.7 cm)
Gas Requirements	Shipped Natural or LP/Propane, field convert with conversion kit (purchased separately); accepts standard residential 1/2" (1.3 cm) ID gas service line
Gas Manifold Pressure	Natural 5.0" W.C.P./ Liquid Propane L/P 10.0" W.C.P.
Electrical Requirements	120VAC/60 Hz; 4 ft. (121.9 cm), 3-wire cord with grounded 3-prong plug attached to unit
Max Amp Usage	2.0 amps
Surface Burner Rating Natural/LP	15,500 BTU (4.5 kW)/13,500 BTU (4.0 kW)
Broil Burner Rating Natural/LP	18,000 BTU (5.3 kW)/16,000 BTU (4.7 kW)
Oven Burner Rating Natural/LP	Right oven – 30,000 BTU (8.8 kW) Nat/LP, Left oven – 15,000 BTU (4.4 kW) Nat/LP
Oven(s) Interior Width	Left oven – 12 1/8" (30.8 cm); Right oven 23" (58.4 cm)
Oven(s) Interior Height	16-1/8" (40.9 cm)
Oven(s) Interior Depth	Overall - 18-3/4" (47.6 cm)
Oven(s) Volume Overall AHAM	Right 4.0 cu. ft. / Left 2.1 cu. ft. Right 3.7 cu. ft. / Left 2.1 cu. ft.
Approximate Shipping Weight	575 lbs. (258.5 kg)

Please do not prepare installation from brochure data only. See installation instructions for important clearance/installation information.
**The AHAM Standard for measuring oven capacity subtracts the door plug and convection baffle dimension from the total oven volume.

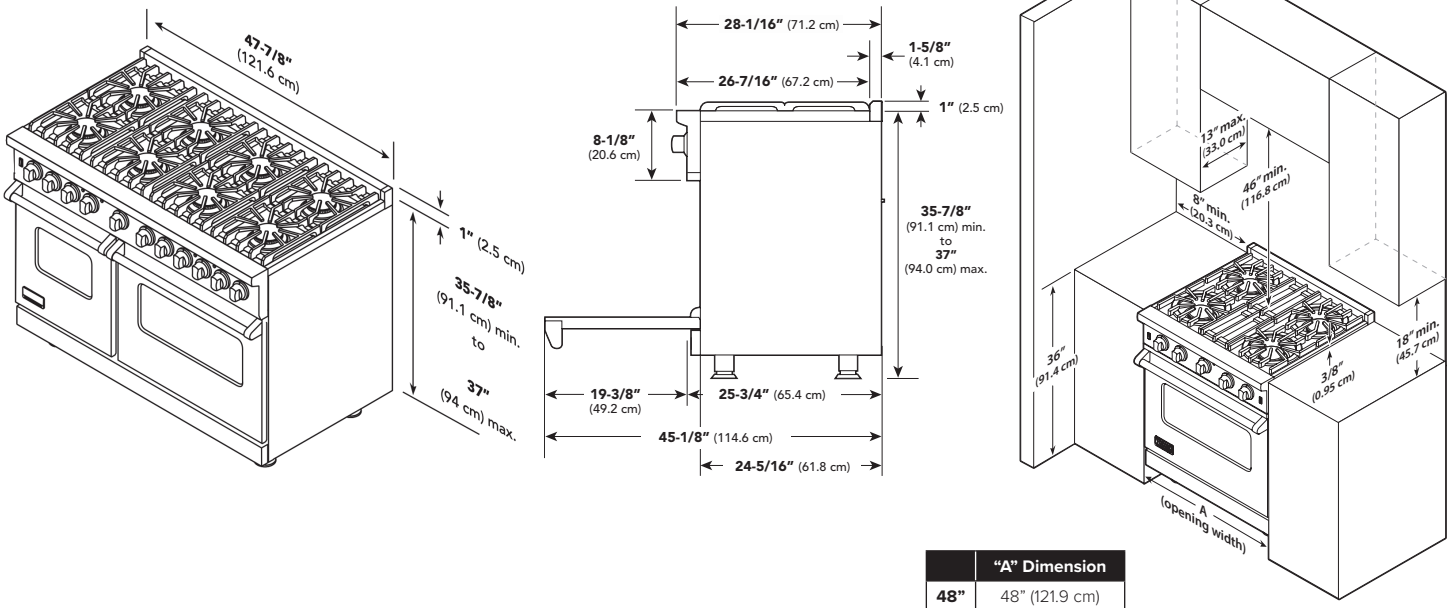

VIKING RANGE, LLC 111 FRONT STREET GREENWOOD, MISSISSIPPI 38930 USA

For detailed product information, model numbers, or to request a quote call 1-888-845-4641 or visit vikingrange.com
© 2023 Viking Range, LLC All rights reserved. Specifications subject to change without notice.