

FISHER & PAYKEL

PRELIMINARY SPECIFICATION GUIDE

COMPACT STEAM OVEN, 24"



OVERVIEW

With timeless Contemporary styling, the compact Combination Steam Oven is designed to fit seamlessly into any kitchen. It features 18 functions, including steam-only, convection-only, or a combination of both. Reduce the need for oils and fats with five standalone steam functions, perfect for creating flavourful and healthy restaurant-quality meals at home. Beautiful to use, the intuitive interface and dial offer simple guided cooking, helping to ensure perfect results.

MODELS

Combination Steam Oven, 24", 18 Function

1.94 cu ft, Stainless steel, Dial
OS24NDLX1

SERIES & STYLE

Series 7
Contemporary

ACCESSORIES

- 1 Large perforated dish
- 2 Large unperforated dish
- 3 Baking tray
- 4 Step down wire shelf

FEATURES

- 1 Contemporary style, designed to fit flush with cabinetry
- 2 1.94 cu ft total capacity
- 3 Intuitive 2.4" screen with illuminated dial
- 4 18 oven functions, including five steam-only functions
- 5 Wired Temperature Sensor precisely monitors cooking in real time
- 6 Guided cooking, with the option to access additional functionality via the SmartHQ™ app*
- 7 Moisture control and even heat distribution thanks to ActiveVent and AeroTech™ technology
- 8 Motorised control panel reveals large 50.7 fl oz water tank
- 9 Soft open and close door
- 10 Wi-Fi/Connected capability*

*Selected markets and models

- 5 Wired Temperature Sensor on selected models*
- 6 Descale solution (2 sachets)
- 7 Telescopic runners
- 8 Flat wire shelf

*Selected markets and models

FISHER & PAYKEL

PRELIMINARY SPECIFICATION GUIDE

COMPACT STEAM OVEN, 24"

SPECIFICATIONS

Model No.	OS24NDLX1
Dimensions	H 18" (458mm) x W 23 7/16" (596mm) x D 22 1/4" (565mm)
Total capacity	1.94 ft cu (55L)
Weight	88 lbs (40kg) unpackaged 115 lbs (52kg) packaged
Electrical	
Supply	208-240V, 60Hz
Service	16.6-19.4 amp circuit

PRODUCT DIMENSIONS

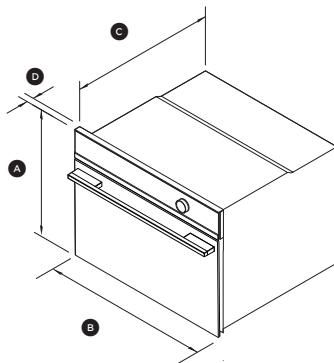

ISO VIEW

		in	mm
(A)	Overall height	18	458
(B)	Overall width	23 7/16	596
(C)	Depth of chassis	21 7/16	545
(D)	Depth from front of chassis to front of oven door (excl.dial & handle)	13/16	20
	Depth of oven door when fully open (measured from front of control panel)	12 5/8	320

CAVITY DIMENSIONS

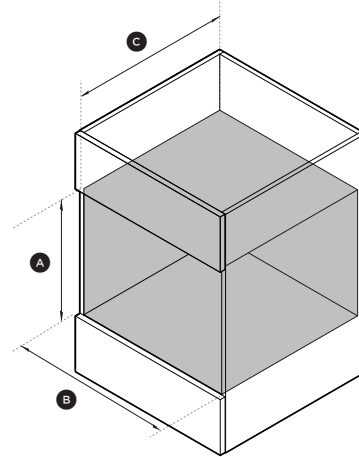

ISO VIEW

		in	mm
(A)	Minimum inside height of cavity	17 5/16	440
(B)	Minimum inside width of cavity	21 1/16	560
(C)	Minimum inside depth of cavity	21 11/16	550