



Scan to see the online manual.



# OWNER'S MANUAL

# **ELECTRIC RANGE**

---

Read this owner's manual thoroughly before operating the appliance and keep it handy for reference at all times.

**ENGLISH**

LDEL7324\*E



MFL05848301  
Rev.02\_040726



[www.lg.com](http://www.lg.com)

Copyright © 2026 LG Electronics. All Rights Reserved

# TABLE OF CONTENTS

## 4 IMPORTANT SAFETY INSTRUCTIONS

---

### 4 READ ALL INSTRUCTIONS BEFORE USE

- 4 Safety Messages
- 4 Anti-tip Device

### 5 WARNING

- 5 Installation
- 5 Operation
- 6 Maintenance
- 6 Risk of Fire and Flammable Materials

### 7 CAUTION

- 7 Operation
- 7 Maintenance

## 8 PRODUCT OVERVIEW

---

### 8 Product Features

- 8 Exterior & Interior
- 8 Product Specifications
- 8 Accessories

## 10 INSTALLATION

---

### 10 Before Installing

- 10 Installation Overview
- 10 Tools Needed
- 11 Parts
- 11 Unpacking and Moving the Range

### 12 Choosing the Proper Location

- 12 Dimensions and Clearances
- 14 Electricity
- 14 Flooring
- 15 Ambient Temperature

### 15 Leveling

- 15 Leveling the Range

### 15 Connecting Electricity

- 15 Electrical Requirements
- 16 Connecting the Power Cord / Conduit

### 20 Anti-tip Device

- 20 Installing the Anti-tip Device

### 21 Test Run

- 21 Test the Range Before Use

## 22 OPERATION

---

### 22 Control Panel

- 22 Control Panel Features
- 23 Knob Features

### 23 Changing Oven Settings

- 23 Clock
- 24 Oven Light
- 24 Timer On/Off
- 24 Wi-Fi
- 24 Settings (Hour Mode, Convection Auto Conversion, Calibrating the Oven Temperature, Preheat Alarm Light, Beeper Volume, Fahrenheit or Celsius, Cooktop on Alert Volume, Wi-Fi On/Off)
- 26 Control Lock
- 27 Start Time (Delayed Timed Cook)
- 27 Cook Time (Timed Cook)
- 28 Minimum & Maximum Default Settings

### 29 Cooktop

- 29 Before Using the Cooktop
- 29 Cooking Areas
- 30 Using the Cooktop Elements
- 32 Turning on the Warm Zone
- 32 Using the Knob Lock
- 32 The Recommended Surface Cooking Setting
- 33 Using the Proper Cookware

### 34 Oven

- 34 Before Using the Oven
- 34 Using Oven Racks
- 34 Bake
- 35 Convection Mode (Lower Oven Only)
- 36 Recommended Baking and Roasting Guide
- 38 Proof (Lower Oven Only)
- 38 Pizza (Upper Oven Only)
- 39 Warm
- 40 Broil
- 42 Recommended Broiling Guide
- 45 Frozen Meal (Lower Oven Only)
- 45 Air Sous-Vide (Lower Oven Only)
- 46 Recommended Air Sous-Vide Guide
- 46 Air Fry (Lower Oven Only)
- 47 Recommended Air Frying Guide
- 49 Remote Start

- 
- 49 Using the Sabbath Mode

## **50 SMART FUNCTIONS**

---

### **50 LG ThinQ Application**

- 50 LG ThinQ Application Features
- 50 Installing LG ThinQ Application and Connecting an LG Appliance
- 51 Installing the LG ThinQ Application
- 51 LG UP Feature
- 51 Connecting to Wi-Fi
- 52 Radio Equipment Specifications
- 52 FCC Statement
- 52 FCC RF Radiation Exposure Statement
- 52 Open Source Software Notice Information

### **52 Smart Diagnosis™ Feature**

- 53 Using LG ThinQ to Diagnose Issues
- 53 Using Audible Diagnosis to Diagnose Issues

## **54 MAINTENANCE**

---

### **54 Cleaning**

- 54 Interior
- 54 Exterior
- 56 Cooktop Surface
- 58 EasyClean
- 61 Self Clean
- 63 Removing/Assembling Lift-Off Oven Doors

### **65 Periodic Maintenance**

- 65 Changing the Oven Light

## **66 TROUBLESHOOTING**

---

### **66 FAQs**

- 66 Frequently Asked Questions

### **68 Before Calling for Service**

- 68 Cooking
- 70 Parts & Features
- 72 Noises
- 73 Wi-Fi

## **74 LIMITED WARRANTY**

---

### **74 USA**

- 74 TERMS AND CONDITIONS
- 74 THIS LIMITED WARRANTY DOES NOT COVER:
- 78 PROCEDURE FOR RESOLVING DISPUTES:

# IMPORTANT SAFETY INSTRUCTIONS

## READ ALL INSTRUCTIONS BEFORE USE

Download this owner's manual at <http://www.lg.com>

### Safety Messages

**Your safety and the safety of others are very important.**

We have provided many important safety messages in this manual and on your appliance. Always read and follow all safety messages.



This is the safety alert symbol.

This symbol alerts you to potential hazards that can kill or injure you and others. All safety messages will follow the safety alert symbol and either the word **WARNING** or **CAUTION**.

These words mean:



#### **WARNING**

You may be killed or seriously injured if you do not follow instructions.



#### **CAUTION**

You may be injured or cause damage to the product if you do not follow instructions.

All safety messages will tell you what the potential hazard is, tell you how to reduce the chance of injury, and tell you what may happen if the instructions are not followed.

### Anti-tip Device

To reduce the risk of tipping, the appliance must be secured by a properly installed anti-tip device. To check if the device is installed properly, verify that the anti-tip device is engaged, or grasp the top rear edge of the range back guard and carefully attempt to tilt it forward. Refer to the installation section for instructions.



#### **WARNING**

- A child or adult can tip the range and be killed.



- Install the anti-tip device to the structure and/or the range. Verify the anti-tip device has been properly installed and engaged by following the guide on the anti-tip bracket template.
- Engage the range to the anti-tip device by following the guide on the anti-tip bracket template. Ensure the anti-tip device is re-engaged when the range is moved by following the guide on the anti-tip bracket template.
- Re-engage the anti-tip device if the range is moved. Do not operate the range without the anti-tip device in place and engaged.
- See installation instructions for details.
- Failure to do so can result in death or serious burns to children or adults.
- Do not rest large, heavy items such as whole turkeys on the open oven door. The range could tip forward and cause injury.

- Do not step or sit on the oven door. The range could be tipped and injury might result from spilled hot liquid, food, or the range itself.
- Never remove the oven legs. The range will not be secured to the anti-tip bracket if the legs are removed.

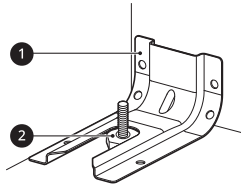

- ❶ Anti-tip bracket
- ❷ Leveling leg

## WARNING

### WARNING

- To reduce the risk of explosion, fire, death, electric shock, injury or scalding to persons when using this product, follow basic precautions, including the following:

## Installation

- Do not line the oven walls, racks, bottom, or any other part of the oven with aluminum foil or any other material. Doing so will disrupt heat distribution, produce poor baking results and cause permanent damage to the oven interior. (Aluminum foil will melt to the interior surface of the oven.)
- To eliminate the risk of burns or fire by reaching over heated surface units, cabinet storage space located above the surface units should be avoided. If cabinet storage is to be provided, the risk can be reduced by installing a range hood that projects horizontally a minimum of 5 inches beyond the bottom of the cabinets.
- Do not use aluminum foil or any other material to line the oven bottom. Improper installation of these liners may result in a risk of electric shock or fire.
- Make sure your range is properly installed and grounded by a qualified installer, according to the installation instructions. Any adjustment and service should be performed only by qualified range installers or service technicians.

## Operation

- Do not leave children alone or unsupervised near the appliance when it is in use or is still hot. Children should never be allowed to sit or stand on any part of the appliance as they could be injured or burned.
- Children should not be allowed to play with controls or other parts of the appliance.
- DO NOT TOUCH HEATING ELEMENTS OR INTERIOR SURFACES OF OVEN. Heating elements may be hot even though they are dark in color. Interior surfaces of an oven become hot enough to cause burns. During and after use, do not touch or let clothing or other flammable materials contact heating elements or interior surfaces of the oven until they have had sufficient time to cool. Other surfaces, such as oven vent openings and surfaces near these openings, oven doors, and windows of oven doors, also get hot and may cause burns if not cooled.
- Surface units may be hot even though they are dark in color. Areas near surface units may become hot enough to cause burns. During and after use, DO NOT TOUCH SURFACE UNITS OR AREAS NEAR UNITS or let clothing or other flammable materials contact surface units or areas near units until they have had sufficient time to cool. This includes the cooktop and the area above the oven door.
- Use care when opening the oven door. The hot air and steam that escape can cause burns to hands, face and eyes. Let hot air or steam escape from the oven before removing or replacing food in the oven.
- Do not use plastic to cover food. Use foil or oven-safe lids only.

## 6 IMPORTANT SAFETY INSTRUCTIONS

---

- Never attempt to dry a pet in the oven.
- Never use your appliance for warming or heating the room.
- Always use pot holders or oven mitts when removing food from the oven or the surface element. Cookware will be hot. Use only dry pot holders. Moist or damp pot holders on hot surfaces may result in burns from steam. Do not let the pot holder touch hot heating elements. Do not use a towel or other bulky cloth to remove food.
- Do not heat unopened food containers. Pressure in the containers may cause them to burst which may result in injury.
- Be certain that all packing materials are removed from the appliance before operating. Keep plastic, clothes, paper, and other flammable materials away from parts of the appliance that may become hot.
- Do not allow aluminum foil or the temperature probe to contact heating elements.
- Do not touch the hot surface between the bottom of the oven door and the top of the drawer on the front of the oven while the oven is in operation. The surface becomes hot and can cause burns and other injury.
- Do not touch the oven racks while they are hot.
- If a rack must be moved while the oven is hot, do not let the pot holder contact the hot heating element in the oven.
- Pull the oven rack to the stop-lock position when loading and unloading food from the oven. This helps prevent burns caused by touching hot surfaces of the door and oven walls.
- Do not use the oven if a heating element develops a glowing spot during use or shows other signs of damage. A glowing spot indicates the heating element may fail and present a potential burn, fire, or shock hazard. Turn the oven off immediately and have the heating element replaced by a qualified service technician.
- During oven operation, the upper surface of the drawer cavity becomes hot and may cause burns. Never allow children to remain unsupervised near the oven or cooktop.
- Do not put your hand inside the drawer while the oven is operating.
- Keep Oven Vent Duct Unobstructed. Areas near the vent may become hot during operation and may cause burns. Do not block the vent opening. Avoid placing plastics near the vent as heat may distort or melt the plastic.
- Never leave any items on the cooktop. The hot air from the vent may ignite flammable items and will increase pressure in closed containers, which may cause them to burst.

### **Maintenance**

- Do not allow children to crawl into the oven.
- Let hot cookware and utensils cool in a safe place, out of reach of small children.
- If the door glass, cooktop glass, surface, or oven heating unit of the range are damaged, discontinue use of the range and call for service.
- Do not allow anyone to climb, stand or hang on the door, storage drawer or cooktop. They could damage the range and even tip it over, causing severe personal injury.
- Always disconnect power from the appliance before servicing.
- Before replacing the oven light, switch off the electrical power to the oven at the main fuse or circuit breaker panel. Failure to do so can result in severe personal injury, death, or electrical shock.
- Never pour cold water over a hot oven for cleaning. Doing so may cause the oven to malfunction.

### **Risk of Fire and Flammable Materials**

- Do not store or use flammable material in the oven or near or on the cooktop. Flammable materials include paper, plastic, pot holders, linens, wall coverings, curtains, and gasoline or other flammable vapors and liquids such as grease or cooking oil. These materials can be ignited when the oven and cooktop are in use.

- Use extreme caution when moving or disposing of hot grease.
- Wear proper apparel. Do not wear loose-fitting or hanging garments, which may ignite if they contact hot surfaces, and cause severe burns.
- Do not use the oven for drying clothes. Only use the oven for its intended purpose.
- If cabinet storage is provided directly above the cooking surface, only use it to store items that are not frequently used and can be safely stored in an area subjected to heat. Temperatures may be unsafe for volatile items such as flammable liquids, cleaners or aerosol sprays.
- Do not use water on grease fires. Should an oven fire occur, leave the oven door closed and turn the oven off. If the fire continues, throw baking soda on the fire or use a fire extinguisher. Do not put water or flour on the fire. Flour may be explosive and water can spread a grease fire and cause personal injury.

## CAUTION

### CAUTION

- To reduce the risk of minor injury to persons, malfunction, or damage to the product or property when using this product, follow basic precautions, including the following:

## Operation

- Always heat fat slowly, and watch as it heats.
- If frying combinations of oils and fats, stir them together before heating.
- Use a deep fat thermometer, if possible, to prevent overheating fat beyond the smoking point.
- Use the least possible amount of fat for effective shallow or deep-fat frying. Filling the pan with too much fat can cause spillovers when food is added.
- Accessible parts may become hot when the broiler is in use.
- Do not place food or cookware on the bottom of the oven cavity. Doing so will cause permanent damage to the oven bottom finish.
- When using cooking or roasting bags in the oven, follow the manufacturer's directions.

## Maintenance

- Do not store items of interest to children in cabinets above a range or on the back guard of a range. Children climbing on the range to reach items could be seriously injured.
- Do not repair or replace any part of the appliance unless specifically recommended in the manual. All other servicing should be performed by a qualified technician.
- Do not use harsh etching, abrasive cleaners or sharp metal scrapers to clean the oven door glass because they can scratch the surface. Scratches may cause the glass to shatter.
- Make sure oven lights are cool before cleaning.
- Do not clean the door gasket. The door gasket is essential for a good seal. Care should be taken not to rub, damage, or move the gasket.
- Clean in the self-clean cycle only parts listed in this manual. Before self-cleaning the oven, remove the broiler pan, all oven racks and any cookware, utensils or food from the oven.

**SAVE THESE INSTRUCTIONS**

# PRODUCT OVERVIEW

## Product Features

### Exterior & Interior

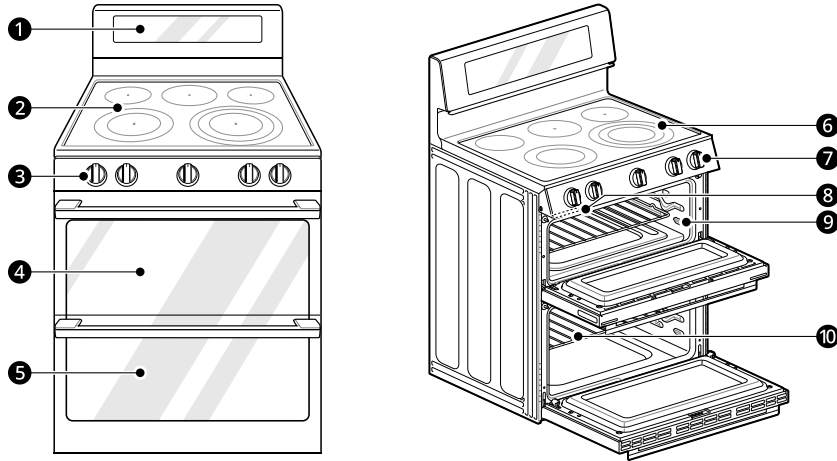

① Oven Controller	⑥ Glass-Ceramic Cooktop
② Cooktop	⑦ Cooktop Control Knob
③ Cooktop Controller	⑧ Model & Serial Number Plate
④ Upper Oven Door	⑨ Gasket
⑤ Lower Oven Door	⑩ Rack

## Product Specifications

The appearance and specifications listed in this manual may vary due to constant product improvements.

Oven Range Models	LDEL7324*E
Description	Electric Freestanding Oven Range
Electrical requirements	LDEL7324*E : 15.2 kW 120/240 VAC or 11.5 kW 120/208 VAC
Exterior Dimensions	29 15/16" (W) x 46 15/32" (H) x 29 1/4" (D) (D with door closed) 76.1 cm (W) x 118.0 cm (H) x 74.3 cm (D) (D with door closed)
Height to cooking surface	36" (91.4 cm)
Total capacity	Upper Oven: 3.0 cu. ft. Lower Oven: 4.3 cu. ft. Total Capacity: 7.3 cu. ft.

## Accessories

### Included Accessories

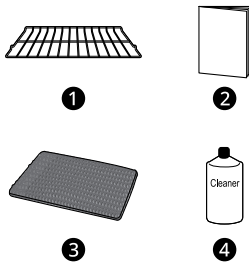

- ❶ Standard Rack (3 ea)
- ❷ Owner's Manual (1 ea)
- ❸ Non-scratch Scouring Pad (1 ea)
- ❹ Cooktop Cleaner (1 ea)

**Optional Accessories (sold separately)**

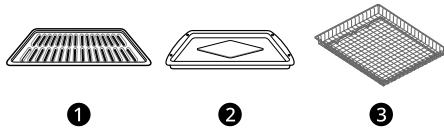

- ❶ Grid
- ❷ Broiler Pan
- ❸ Air Fry Tray

**NOTE**

- Contact LG Customer Service at 1-800-243-0000 (1-888-542-2623 in Canada) if any accessories are missing.
- For your safety and for extended product life, only use authorized components.
- The manufacturer is not responsible for product malfunction or accidents caused by the use of separately purchased, unauthorized components or parts.
- The images in this guide may be different from the actual components and accessories, which are subject to change by the manufacturer without prior notice for product improvement purposes.

# INSTALLATION

## Before Installing

### Installation Overview

Please read the following installation instructions first after purchasing this product or transporting it to another location.

The images in this guide may be different from the actual components and accessories, which are subject to change by the manufacturer without prior notice for product improvement purposes.

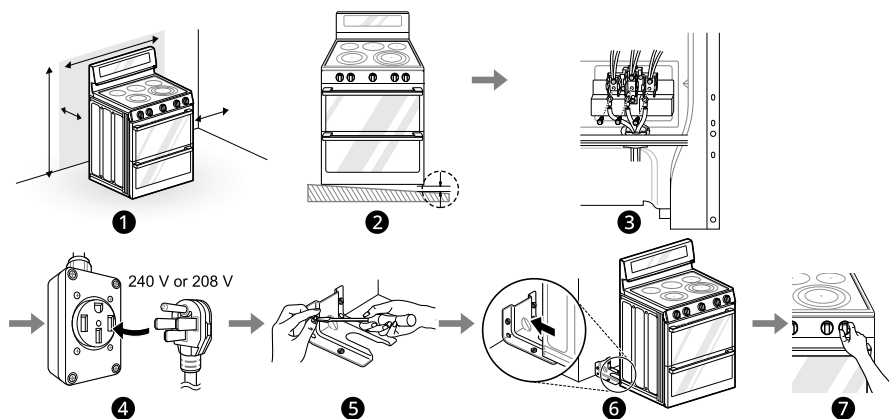

① Check and choose the proper location	② Level the range
③ Connect electric range	④ Plug in the power cord
⑤ Install anti-tip device	⑥ Engage the anti-tip device
⑦ Test run	

### Tools Needed

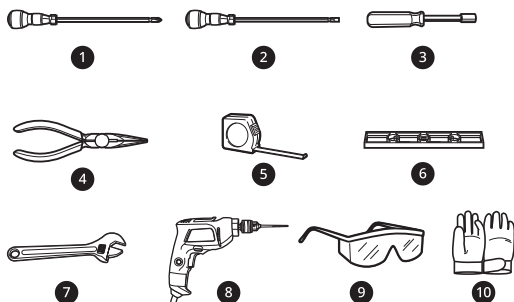

- ① Phillips screwdriver
- ② Flat-blade screwdriver
- ③ 1/4" nut driver
- ④ Pliers
- ⑤ Tape measure

- ⑥ Level
- ⑦ Adjustable wrench
- ⑧ Drill
- ⑨ Safety glasses
- ⑩ Gloves

## Parts

### Parts Provided

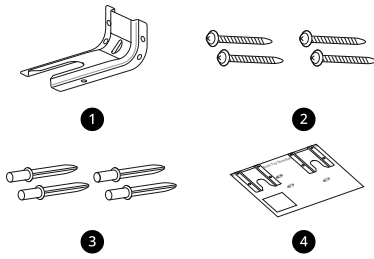

- ❶ Anti-tip bracket (1 ea)
- ❷ Screws (4 ea)
- ❸ Anchors (4 ea)
- ❹ Template (1 ea)

### Parts Not Provided

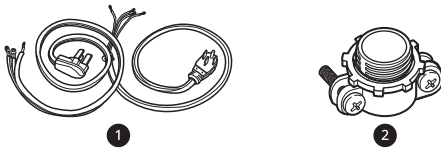

- ❶ 4-Wire cord or 3-Wire cord (UL approved 40 or 50 AMP)
- ❷ Strain relief (for conduit installations only)

### NOTE

- Observe all governing codes and ordinances.
- Have the installer show you the location of the circuit breaker or fuse. Mark it for easy reference.
- As when using any appliance generating heat, follow common-sense safety precautions.
- Be sure your range is installed and grounded properly by a qualified installer or service technician.

Doing so can result in serious damage to the range.

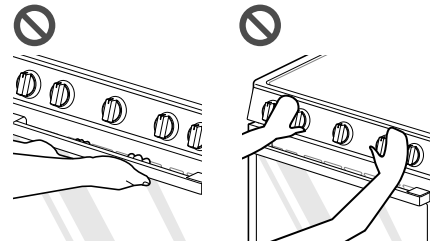

- Do not push or pull the range by grabbing the open oven door or cooktop only. Doing so can result in serious damage to the range.

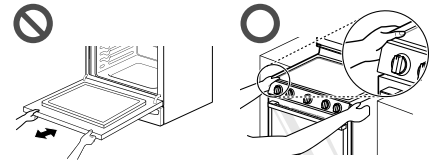

- Do not lift the range using the cooktop or door handle. Doing so can cause damage and improper operation of the range.



- To reduce the risk of burns, do not move this appliance while it is hot.

### NOTE

- The image may differ from the actual model.

## Unpacking and Moving the Range

### ⚠ WARNING

- You should use two or more people to move and install the range. (Excessive Weight Hazard) Failure to do so can result in back or other injury.
- Do not use the door handles or knobs to push or pull the range during installation or when moving the range out for cleaning or service.

**NOTE**

- Your range is heavy and can be installed on soft floor coverings such as cushioned vinyl or carpeting. Use care when moving the range on this type of flooring. Use a belt when moving the range to prevent damaging the floor. Or slide the range onto cardboard or plywood to avoid damaging the floor covering.

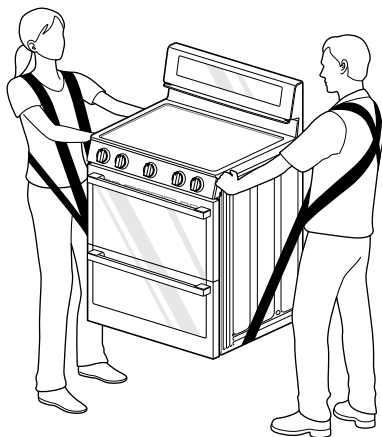

- Remove packing material, tape and any temporary labels from your range before using. Do not remove any warning-type labels, the model and serial number label, or the Tech Sheet that is located on the back of the range.
- To remove any remaining tape or glue, rub the area briskly with your thumb. Tape or glue residue can also be easily removed by rubbing a small amount of liquid dish soap over the adhesive with your fingers. Wipe with warm water and dry.
- Do not use sharp instruments, rubbing alcohol, flammable fluids, or abrasive cleaners to remove tape or glue. These products can damage the surface of your range.

## Choosing the Proper Location

### Dimensions and Clearances

#### Dimensions

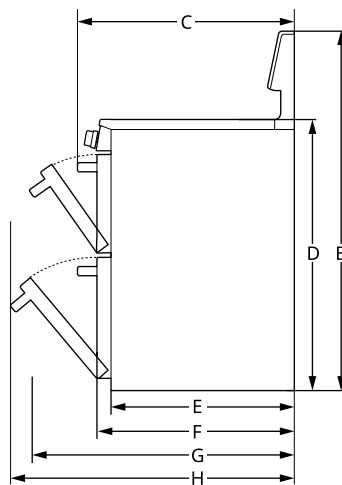
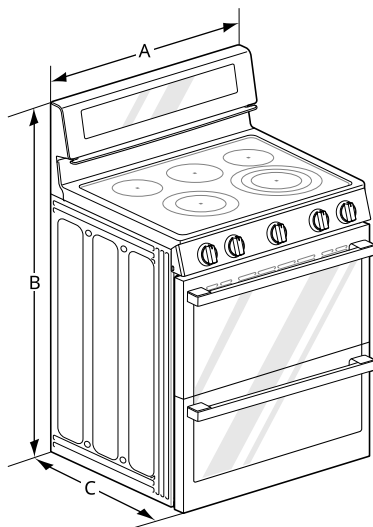

-	Dimensions	LDEL7324*E
A	Width	29 15/16" (760.8 mm)

-	Dimensions	LDEL7324*E
B	Height	46 15/32" (1180.1 mm)
C	Depth (Includes Door Handle)	29 1/4" (743.1 mm)
D	Height (Cooking surface)	36" (914.4 mm)
E	Depth (Includes only the product body that is loaded into the cabinet. Excludes door, drawer, and handles)	24 3/4" (628.5 mm)
F	Depth (Excludes Door Handle)	26 27/32" (682.0 mm)
G	Depth when upper door is fully opened	38 5/8" (981.2 mm)
H	Depth when lower door is fully opened	42 3/16" (1072.2 mm)

### Minimum Dimensions

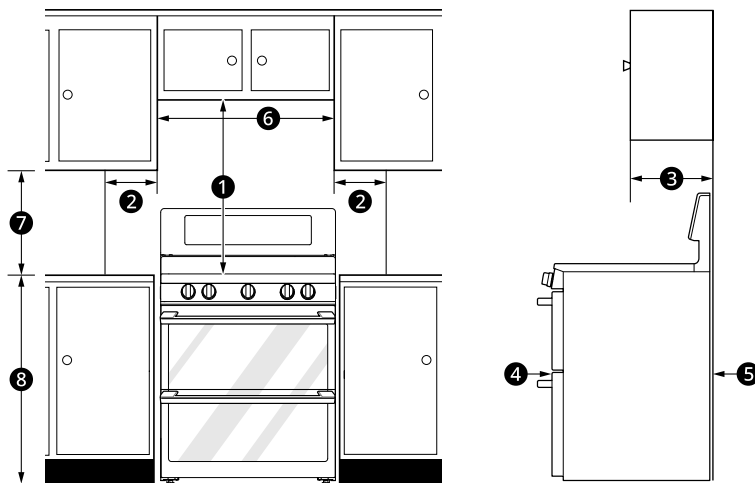

① Minimum distance from top of range to combustible surface overhead	30" (76.2 cm)
② Minimum clearance to left/right wall	5" (12.7 cm)
③ Maximum depth for cabinets above countertops	13" (33.0 cm)
④ Front edge of the range side panel forward from cabinet	2 1/4" (6.3 cm)
⑤ To cabinets below cooktop and at the range back	0"
⑥ Minimum opening in overhead cabinets	30" (76.2 cm)
⑦ Minimum distance from countertop to overhead cabinets at side	15" (38.1 cm)
⑧ Height of countertop	36" (91.4 cm)

### NOTE

- ① 30" (76.2 cm) minimum clearance between the top of the cooking surface and the bottom of an unprotected wood or metal cabinet; or 24" (60.9 cm) minimum when bottom of wood or metal cabinet is protected by not less than 1/4" (0.64 cm) flame retardant millboard covered with not less than no. 28 MSG sheet steel, 0.015" (0.381 mm) stainless steel, 0.024" (0.610 mm) aluminum or 0.020" (0.508 mm) copper.

## 14 INSTALLATION

### NOTE

- ⑦ 15" (38.1 cm) minimum between countertop and adjacent cabinet bottom.
- Important – Save for the use of the local electrical inspector.
- For installation in Canada, a free-standing range is not to be installed closer than 15/32" (12 mm) from any adjacent surface.

### Clearances

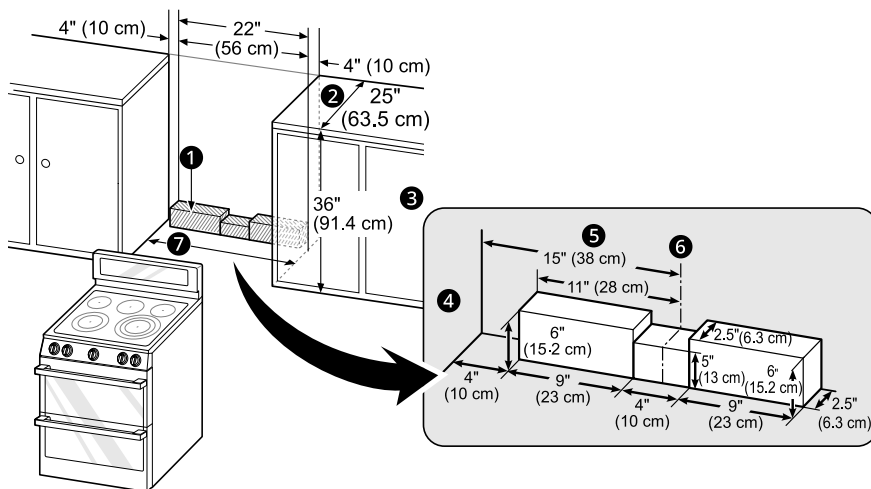

① Acceptable Electrical Outlet Area	② Normal Countertop Depth
③ Countertop Height	④ Cabinet
⑤ Wall	⑥ Center
⑦ Cabinet opening = 30" (76.2 cm) For U.S.A = 30" (76.2 cm) ~ 31" (78.7 cm) For CANADA	

### Electricity

The range should always be plugged into its own individual properly grounded electrical outlet.

- This prevents overloading house wiring circuits which could cause a fire hazard from overheated wires.
- It is recommended that a separate circuit serving only this appliance be provided.

### Flooring

#### ⚠ CAUTION

- Use an insulated pad or 1/4 in. (0.64 cm) plywood under the range if installing the range over carpeting.

## Ambient Temperature

### ⚠ CAUTION

- Make sure wall coverings, countertops and cabinets around the range can withstand the heat (up to 194 °F) generated by the range. Discoloration, delamination or melting may occur. This range has been designed to comply with the maximum allowable wood cabinet temperature of 194 °F.
- Before installing the range in an area covered with linoleum or other synthetic floor covering, make sure the floor covering can withstand temperatures of at least 200 °F (93 °C).

## Leveling

### Leveling the Range

Level the range by adjusting the leveling legs with a wrench. Extending the legs slightly may also make it easier to insert the rear leg into the anti-tip bracket.

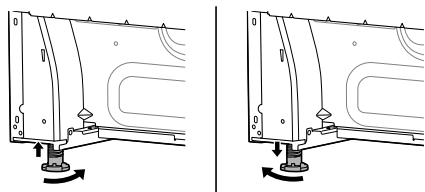

### Checking Adjustments

- 1 Place the level diagonally on the oven rack, and check each direction for level.
  - First check direction ①. Then check direction ②.

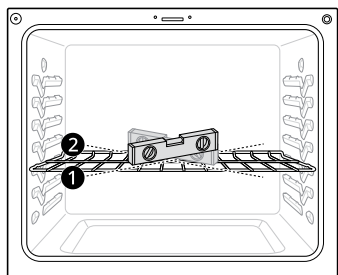

- 2 If the level doesn't show that the rack is level, adjust the leveling legs with a wrench.

## Connecting Electricity

### Electrical Requirements

This appliance must be installed and grounded on a branch circuit by a qualified technician in accordance with the National Electrical code ANSI/NFPA NO. 70 - latest edition.

All wiring should conform to local and NEC codes. This range requires a single-phase, 3 wire, AC 120/208 V or 120/240 V 60 Hz electrical system. Use only a 3-conductor or a 4-conductor UL - listed range cord with closed-loop terminals, open-end spade lugs with upturned ends or similar termination. Do not install the power cord without a strain relief.

A range cord rated at 40 amps with 120/240 V minimum range is required.

If a 50 amp range cord is used, it should be marked for use with 1 3/8" diameter connection openings. This appliance may be connected by means of a conduit or power cord. If a conduit is being used, refer to "3-Wire Connection: Conduit" or "4-Wire Connection: Conduit" sections.

### ⚠ WARNING

- Allow 2 to 3 ft (61.0 cm to 91.4 cm) of slack in the line so that the range can be moved if servicing is ever necessary.
- The power supply cord and plug should not be modified. If the plug will not fit the outlet, have a proper outlet installed by a qualified electrician.
- Using an extension cord to connect the power is prohibited. Connect the power cord and plug directly.
- Electrical ground is required on this appliance.
- Make sure that the power cord is not pinched by the range or heavy objects. Failure to do so can result in serious burns or electrical shock.

## Specified Power Cord Kit Rating

### Case 1

- Voltage: 120/240 volts (3-wire)
- Range rating: 8,750 W - 16,500 W
- Specified rating of power supply-cord kit, amperes: 40 A or 50 A
- Diameter (inches) of range connection opening
  - Power cord: 1 3/8"
  - Conduit: 1 1/8"

### Case 2

- Voltage: 120/240 volts (3-wire)
- Range rating: 16,501 W - 22,500 W
- Specified rating of power supply-cord kit, amperes: 50 A
- Diameter (inches) of range connection opening
  - Power cord: 1 3/4"
  - Conduit: 1 3/8"

### Case 3

- Voltage: 120/208 volts (3-wire)
- Range rating: 7,801 W - 12,500 W
- Specified rating of power supply-cord kit, amperes: 40 A or 50 A
- Diameter (inches) of range connection opening
  - Power cord: 1 3/8"
  - Conduit: 1 1/8"

### Case 4

- Voltage: 120/208 volts (3-wire)
- Range rating: 12,501 W - 18,500 W
- Specified rating of power supply-cord kit, amperes: 50 A
- Diameter (inches) of range connection opening
  - Power cord: 1 3/4"
  - Conduit: 1 3/8"

## 3, 4 - Wire Electrical Wall Receptacle



4 Wire receptacle (14-50R)



3 Wire receptacle (10-50R)

## Connecting the Power Cord / Conduit

The rear access cover **1** must be removed. Loosen the two screws with a screwdriver. The terminal block will then be accessible.

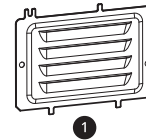

Use the cord/conduit connection plate **2** to install the power cord or conduit. Leave the connection plate as installed for power cord installations. Remove the connection plate for conduit installations and rotate it to use the smaller 1 1/8 in. (2.8 cm) conduit hole **3** instead of the 1 3/8 in. (3.5 cm) power cord hole **4**.

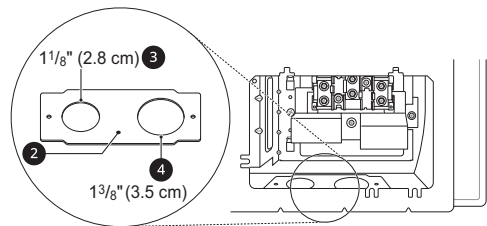

For power cord **5** installations, hook the strain relief over the 1 3/8 in. (3.5 cm) power cord hole located below the rear of the oven. Insert the power cord through the strain relief and tighten it.

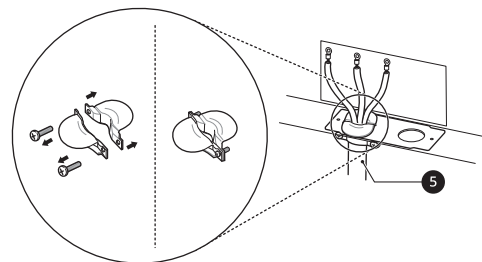

For conduit installations, insert the conduit strain relief in the 1 1/8 in. (2.8 cm) conduit hole. Then install the conduit through the body of the strain relief and fasten the strain relief with its ring.

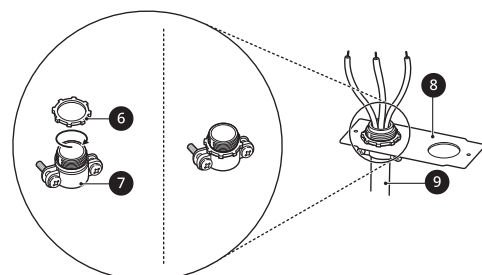

- 6 Ring
- 7 Body
- 8 Cord/Conduit Connection Plate
- 9 Conduit

### 3-Wire Connection: Power Cord

#### ⚠ WARNING

- The white middle (neutral or ground) wire of a 3-wire power cord or a 3-wire conduit has to be connected to the middle post of the main terminal block. The remaining two wires of the power cord or conduit have to be connected to the outside posts of the main terminal connection block. Failure to do so can result in electrical shock, severe personal injury or death.
- If screws are not tightened securely, it can result in electrical spark and severe personal injury or death.

- 1 For power cord installations, hook the strain relief over the power cord hole (1 3/8") located below the rear of the oven.
- 2 Insert the power cord through the strain relief and tighten it.

#### ⚠ CAUTION

- Do not install the power cord without a strain relief.

- 3 Remove the lower 3 screws from the terminal block and retain them.
- 4 Insert the 3 screws through each power cord terminal ring and into the lower terminals of the terminal block.
  - Make sure that the white center wire is connected to the center lower position of the terminal block.

- 5 Tighten the 3 screws securely into the terminal block.

#### ⚠ CAUTION

- Do not remove the ground strap connections.

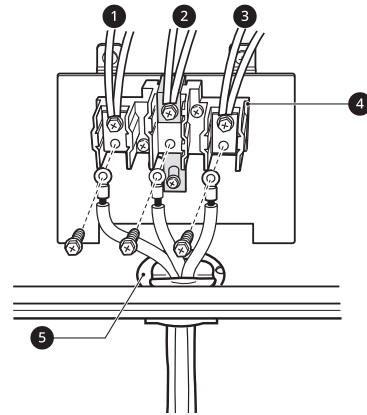

- 1 Black
- 2 White
- 3 Red
- 4 Terminal Block
- 5 Cord/Conduit Connection Plate

### 4-Wire Connection: Power Cord

#### ⚠ WARNING

- Only a 4-conductor power-supply cord kit rated 120/240 volts, 50 amperes and marked for use with ranges with closed-loop connectors or opened spade lugs with upturned ends must be used. The white middle (neutral) wire of the power cord or 4-wire conduit has to be connected to the middle post of the main terminal block. The other two wires of the power cord or conduit have to be connected to the outside posts of the main terminal connection block. The 4th ground wire (green) must be connected to the frame of the range with the ground screw. Failure to do so can result in electrical shock, severe personal injury or death.
- If screws are not tightened securely, it can result in electrical spark and severe personal injury or death.

- 1 For power cord installations, hook the strain relief over the power cord hole (1 3/8") located below the rear of the oven.

## 18 INSTALLATION

- Insert the power cord through the strain relief and tighten it.

### ⚠ CAUTION

- Do not install the power cord without a strain relief.

- Remove the lower 3 screws from the terminal block and retain them.

- Remove the ground screw and bend the end of the ground strap up so the slot is over the hole of the center screw removed in step 3.

- Insert the ground screw into the power cord ground wire (green) terminal ring and secure it to the range frame.

- Insert the 3 screws through each power cord terminal ring and into the lower terminals of the terminal block.

- Make sure that the white center (neutral) wire is connected to the center lower position of the terminal block.

- Tighten the 3 screws securely into the terminal block.

- The center screw now attaches the bent up ground strap to the block.

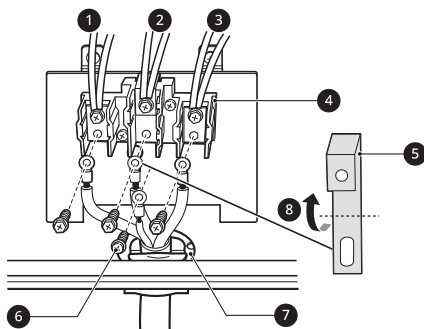

- Black
- White
- Red
- Terminal Block
- Ground Strap

- Ground Screw
- Cord/Conduit Connection Plate
- Bend strap up and attach.

## 3-Wire Connection: Conduit

### ⚠ WARNING

- If screws are not tightened securely, it can result in electrical spark and severe personal injury or death.

## Conduit Installations

### ⚠ CAUTION

- Do not install the conduit without a strain relief.

- Remove the cord/conduit connection plate from the rear of the oven and rotate it.

- The conduit hole (1 1/8") must be used.

- Prepare the conduit wires as shown below.

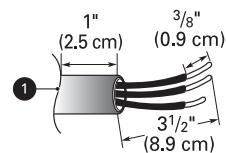

- Cord/Conduit connection plate

- Install the conduit strain relief.

- Insert the strain relief in the 1 1/8 in. (2.8 cm) conduit hole.
- Install the conduit through the body of the strain relief and fasten the strain relief with its ring.

### NOTE

- For conduit installations, purchase a strain relief.

- Reinstall the cord/conduit connection plate.

## Conduit Connections

If the wire in the conduit is copper it must be 8 or 10 AWG wiring.

If the wire in the conduit is aluminum it must be 6 or 8 AWG wiring.

- 1 Loosen the lower 3 screws from the terminal block.
- 2 Insert the bare wire (white/neutral) end through the center terminal block opening. Do not remove the ground strap connections.
- 3 Insert the two side bare wire ends into the lower left and the lower right terminal block openings.
- 4 Tighten the 3 screws securely into the terminal block. (approximately 35 - 50 IN-LB)

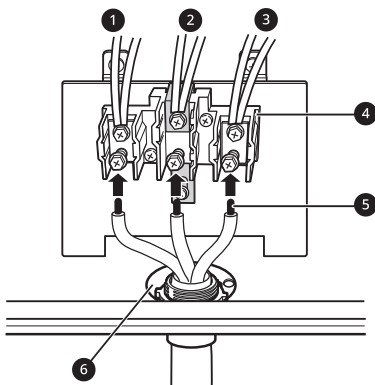

- 1 Black
- 2 White
- 3 Red
- 4 Terminal Block
- 5 Wire Ends
- 6 Conduit Connection Plate

### 4-Wire Connection: Conduit

#### ⚠ WARNING

- The white middle (neutral) wire of the power cord or 4-wire conduit has to be connected to the middle post of the main terminal block. The other two wires of the power cord or conduit have to be connected to the outside posts of the main terminal connection block. The 4th ground wire (green) must be connected to the frame of the range with the ground screw. Failure to do so can result in electrical shock, severe personal injury or death.

- If screws are not tightened securely, it can result in electrical spark and severe personal injury or death.

### Conduit Installations

#### ⚠ CAUTION

- Do not install the conduit without a strain relief.

- 1 Remove the cord/conduit connection plate from the rear of the oven and rotate it.
  - The conduit hole (1 1/8") must be used.
- 2 Prepare the conduit wires as shown below.

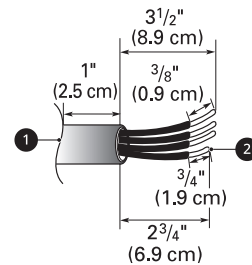

- 1 Cord/Conduit Connection Plate
- 2 Ground Wire

- 3 Install the conduit strain relief.
  - 1) Insert the strain relief in the 1 1/8 in. (2.8 cm) conduit hole.
  - 2) Install the conduit through the body of the strain relief and fasten the strain relief with its ring.

#### NOTE

- For conduit installations, purchase a strain relief.

- 4 Reinstall the cord/conduit connection plate.

### Conduit Connections

If the wire in the conduit is copper it must be 8 or 10 AWG wiring.

If the wire in the conduit is aluminum it must be 6 or 8 AWG wiring.

- 1 Loosen the 2 lower left and right screws from the terminal block. Remove the lower 2 center screws. Do not discard any screws.

- 2 Remove the ground screw and bend the end of the ground strap up so the slot is over the hole of the center screw removed in step 1.
- 3 Attach the ground (green) bare wire end to the range frame and secure it in place with the ground screw.
- 4 Insert the bare wire (white/neutral) end through the center terminal block opening. The center screw now attaches the bent up ground strap to the block.
- 5 Insert the two side bare wire ends into the left and the right terminal block openings. Tighten the 3 screws securely into the terminal block. (approximately 35 - 50 IN-LB)

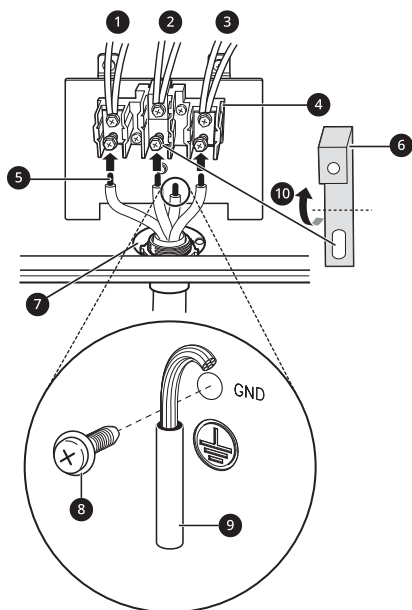

- 1 Black
- 2 White
- 3 Red
- 4 Terminal Block
- 5 Wire Ends
- 6 Ground Strap
- 7 Conduit Connection Plate
- 8 Ground Screw
- 9 Ground Wire

- 10 Bend strap up and attach.

## Anti-tip Device

### Installing the Anti-tip Device

#### Tip Hazard

#### **⚠ WARNING**

- A child or adult can tip the range and be killed.



- Install the anti-tip device to the structure and/or the range. Verify the anti-tip device has been properly installed and engaged by following the guide on the anti-tip bracket template.
- Engage the range to the anti-tip device by following the guide on the anti-tip bracket template. Ensure the anti-tip device is re-engaged when the range is moved by following the guide on the anti-tip bracket template.
- Re-engage the anti-tip device if the range is moved. Do not operate the range without the anti-tip device in place and engaged.
- See installation instructions for details.
- Failure to follow these instructions can result in death or serious burns to children or adults.
- Range must be secured with an approved anti-tip device.
- The range could be tipped by standing, sitting or leaning on an open door if the range or anti-tip device is not properly installed.
- The use of this device does not preclude tipping of the range when not properly installed.

- After installing the anti-tip device, verify that it is in place by carefully attempting to tilt the range forward.
- This range has been designed to meet all recognized industry tip standards for all normal conditions.
- The installation of the anti-tip device must meet all local codes for securing the appliance.

#### Using the Anti-tip Bracket Template

- The anti-tip bracket is packaged with an installation template. The instructions include necessary information to complete the

installation. Read and follow the range installation instruction sheet.

- Screws ③ must enter wood or concrete.

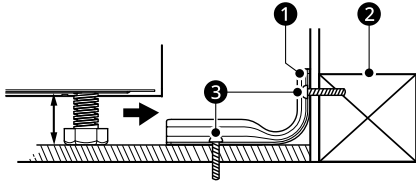

- ① Anti-tip Bracket
- ② Wall Plate

### Engaging the Anti-tip Device

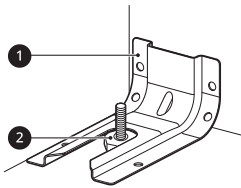

- ① Anti-tip Bracket
- ② Leveling Leg

- 1 Slide the range against the wall, making sure the back leg slides into and engages the anti-tip bracket.
- 2 Check for proper installation by grasping the front edge of the cooktop and carefully attempting to tilt the range forward.

## Test Run

### Test the Range Before Use

Check if the range is properly installed and run a test cycle.

- 1 Before using the cooktop for the first time, clean it with a ceramic cooktop cleaner. This helps protect the top and makes cleanup easier.
- 2 Press **CLEAR/OFF**.
- 3 Turn each knob to the **HI** position to check that the surface heating elements are working properly. The elements should glow

red and radiate heat, and they should cycle on and off periodically even when the knob is in the **HI** position. This cycling prevents the glass-ceramic from being cracked by thermal shock.

### NOTE

- The Warm Zone does not consume enough power to glow red.

- 4 After checking all the surface heating elements, check the locking system by pressing **Control Lock** for three seconds. The oven controller should lock and the cooktop should not operate while the Control Lock function is turned on. Press **Control Lock** for three seconds to disable Control Lock.

- 5 Now check the oven's operation. Press **Bake** button once. 350 °F appears in the display. Press **START**.

- 6 The oven should finish preheating in 15 minutes, and the convection fan should operate while the oven is preheating.

- 7 After checking the oven's operation, turn the temperature up to 450 °F and leave the oven on for at least an hour to help remove any oil which might cause smoke and odors when first using the oven.

### NOTE

- Smoke may come out of the range when it is first used.

# OPERATION

## Control Panel

### Control Panel Features

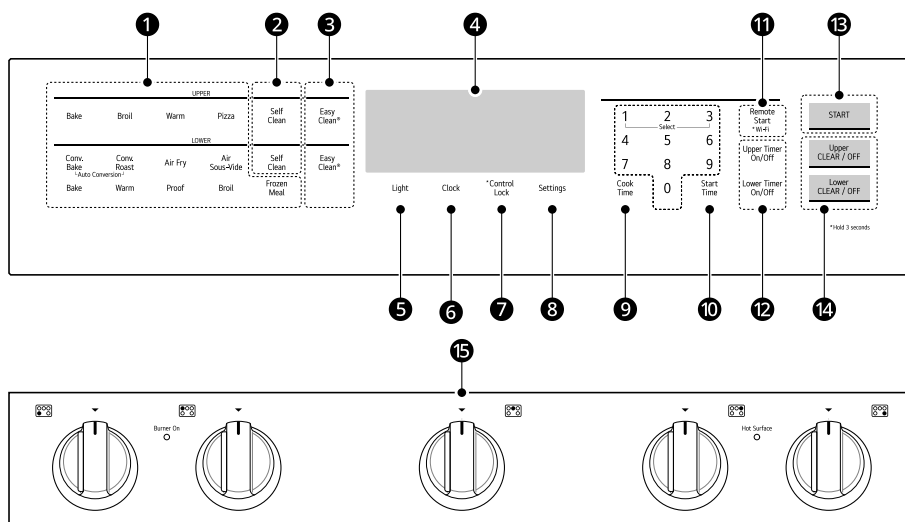

#### 1 Oven Controls

Press a button to select the oven operating mode.

#### 2 Self Clean

Press the button to set the **Self Clean**.

#### 3 EasyClean

Press the button to set the **EasyClean**.

#### 4 Display

Press any button on the control panel to activate the display.

#### 5 Light

Press the button to turn both oven lights on or off.

#### 6 Clock

Press the button to set the time of day.

#### 7 Control Lock

Press and hold the button for 3 seconds to lock the control panel.

#### 8 Settings

Press the button to select and adjust oven settings.

#### 9 Cook Time

Press the button to set the desired amount of time for food to cook. The oven shuts off when the set cooking time runs out.

#### 10 Start Time

Press the button to set the delayed timed cook. The oven starts at the set time.

#### 11 Remote Start / Wi-Fi

- Press the button to set **Remote Start**.
- Press and hold the button for 3 seconds to connect the appliance to a Wi-Fi network.

#### 12 Timer On/Off

Press the button to set or cancel the timer.

#### 13 START

Press the button to start all oven features.

#### 14 CLEAR/OFF

Press the button to end all oven features.

#### 15 Cooktop Controller

Turn the knobs to use the cooktop elements.

### NOTE

#### • Setting the Time, Timer and Temperature

If you enter one digit of a number incorrectly, enter the entire number again to correct it. For example, if you press 1, 0, 3 and 1 to set the clock for 10:30, press 1, 0, 3 and 0 to enter the correct time.

## Knob Features

After cleaning the cooktop control knobs, make sure to replace each knob in the correct position. Failure to do so can result in improper operation of the burners.

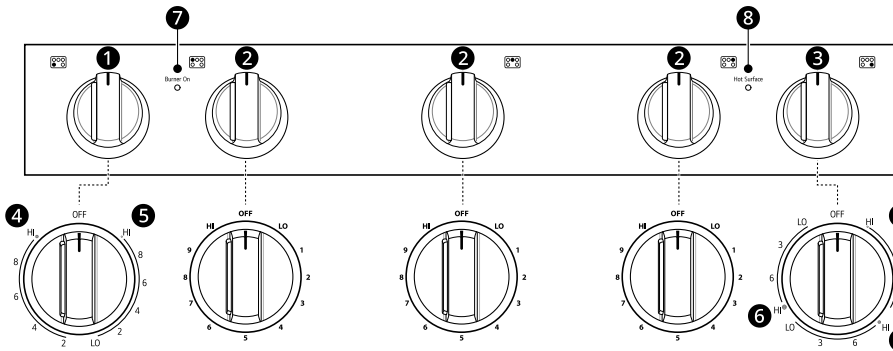

- ❶ Dual (Mark A)
- ❷ Single (Mark C)
- ❸ Triple (Mark B)

-	❹ Dual	❺ Single	❻ Triple
Icon Type 1	• •	•	• • •
Icon Type 2	⊙	○	⊙

- ❷ **Burner ON** Indicator
- ❸ **Hot Surface** Indicator

### NOTE

- When reassembling the knobs, refer to the marks for the correct orientation.

## Changing Oven Settings

### Clock

The clock must be set to the correct time of day in order for the automatic oven timing functions to work properly.

- 1 Press **Clock**.
- 2 Press the numbers to enter the time. For example, to set the clock for 10:30, press the numbers: 1, 0, 3 and 0.
- 3 Press **START**.

### NOTE

- The time of day cannot be changed during a timed baking or self-clean cycle.
- To check the time of day when the display is showing other information, press **Clock**.
- If no other buttons are pressed within 25 seconds of pressing **Clock**, the display reverts to the original setting.
- If the display time is blinking, there may have been a power failure. Reset the time.
- The control is set to use a 12-hour clock. To set the clock to 24-hour mode, see the Settings section.

## Oven Light

The interior oven light automatically turns on when the door is opened.

- Press **Light** to manually turn both oven lights on or off.

### NOTE

- The oven light cannot be turned on if the Self Clean function is active.

## Timer On/Off

The Timer serves as an extra timer in the kitchen that beeps when the set time has run out. It does not start or stop cooking.

The Timer feature can be used during any of the other oven control functions.

The Upper and Lower Timer can be operated independently of each other.

### For example, to set 5 minutes:

- 1 Press **Upper Timer On/Off** or **Lower Timer On/Off** once.  
0:00 appears and **Timer** flashes in the display.

### NOTE

- Press **Upper Timer On/Off** or **Lower Timer On/Off** twice to set the time in minutes and seconds.
- Press **Upper Timer On/Off** or **Lower Timer On/Off** once to set the time in hours and minutes.

- 2 Press **5**.  
0:05 appears in the display.

- 3 Press **Upper Timer On/Off** or **Lower Timer On/Off** to start the Timer. The remaining time countdown appears in the display.

### NOTE

- If **Upper Timer On/Off** or **Lower Timer On/Off** is not pressed, the timer returns to the time of day.

- 4 When the set time runs out, **End** shows in the display. The indicator tones sound every 15

seconds until **Upper Timer On/Off** or **Lower Timer On/Off** is pressed.

### NOTE

- If the remaining time is not in the display, recall the remaining time by pressing **Upper Timer On/Off** or **Lower Timer On/Off**.

## Canceling the Timer

- 1 Press **Upper Timer On/Off** or **Lower Timer On/Off** once.  
The display returns to the time of day.

## Wi-Fi

The **Wi-Fi** button is used to connect the appliance to a home Wi-Fi network.

- 1 Press and hold **Remote Start** for 3 seconds.
- 2 The power on chime sounds, **SET** appears in the display, and the Wi-Fi icon (📶) blinks.
- 3 Connect the appliance to the Wi-Fi network using the **LG ThinQ** smartphone application.
- 4 To disconnect the appliance from the network, delete it from the connected appliances in the application.

### NOTE

- See the Smart Functions section in the owner's manual for more details.

## Settings (Hour Mode, Convection Auto Conversion, Calibrating the Oven Temperature, Preheat Alarm Light, Beeper Volume, Fahrenheit or Celsius, Cooktop on Alert Volume, Wi-Fi On/Off)

Press the **Settings** button repeatedly to toggle through and change oven settings.

The **Settings** button allows you to:

- **set the hour mode on the clock (12 or 24 hours)**

- enable/disable convection auto conversion
- calibrate the oven temperature
- activate/deactivate the preheating alarm light
- set the beeper volume
- switch the temperature scale between Fahrenheit and Celsius
- set the cooktop on alert volume
- activate/deactivate the Wi-Fi

## Setting the Hour Mode

The control is set to use a 12-hour clock. To set the clock to 24-hour mode, follow the steps below.

- 1 Press **Settings** once.
- 2 Press **1** to toggle between a 12-hour and 24-hour clock.
- 3 Press **START** to accept the change.

## Setting Convection Auto Conversion

When **Conv. Bake** and **Conv. Roast** are selected, Convection Auto Conversion automatically converts the standard recipe temperature entered to a convection temperature by subtracting 25 °F / 14 °C. This auto converted temperature shows on the display. For example, select **Conv. Bake**, enter 350 °F, and 325 °F shows on the display after preheat.

Convection Auto Conversion is enabled by default. To change the setting, follow these instructions.

- 1 Press **Settings** repeatedly until **Auto** appears in the display.
- 2 Press **1** to disable or enable auto conversion.
- 3 Press **START** to accept the change.

### NOTE

- The convection cooking mode uses air circulation to cook faster and more evenly than the normal cooking mode, so you can get better cooking results than normal baking even when the temperature is reduced by 25°F / 14°C.

## Calibrating the Oven Temperature

When you start using the oven, pay careful attention to the recommended temperatures, times, and rack positions in the manual. This oven may differ from your previous oven, and it may take some time to become accustomed to it. If you have followed the recommended guides for this oven and still believe that the temperature is hotter or colder than expected, you can manually calibrate the displayed oven temperature.

There are 2 methods for adjusting the temperature display.

- Method 1: Try to gauge how much to increase or decrease the displayed temperature by testing familiar recipes at higher or lower temperatures than recommended. This may help you decide the amount of temperature adjustment you want.
- Method 2: Adjust the temperature to 15 °F (8 °C) hotter or cooler at first. Try the oven with this setting. If you still need to adjust the oven temperature, use the results of the first adjustment as a reference and vary the temperature adjustment amount until the oven temperature display is calibrated to your satisfaction.

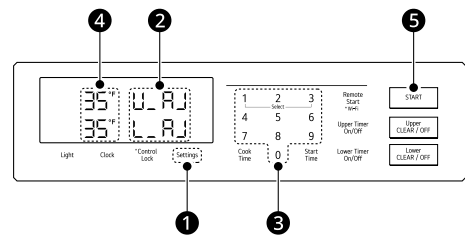

- 1 To adjust the lower oven, press the **Settings** button **1** repeatedly until **L\_RJ** **2** shows in the display. To adjust the upper oven, press the **Settings** button **1** repeatedly until **U\_RJ** **2** shows in the display.
- 2 Use the number buttons **3** to enter the number of degrees you want to adjust the oven temperature. The temperature adjustment is shown next to **U\_RJ** or **L\_RJ** **4**. You can adjust the temperature up or down by 35 °F or 19 °C.
- 3 To lower the temperature, press **Settings** **1** to add a minus sign (-) to the displayed number. To raise the temperature, press **Settings** **1** to remove the minus sign in the display.

- Press **START**  to accept the change.

#### NOTE

- This adjustment does not affect the broiling or Self Clean temperatures. The adjustment is retained in memory after a power failure. The oven temperature can be adjusted by  $\pm 35$  °F ( $\pm 19$  °C).
- Once the temperature is adjusted, press **Settings** repeatedly until  $\downarrow_{RJ}$  or  $\downarrow_{RJ}$  is displayed to see the amount you adjusted and change it if needed.
- The temperatures displayed by an oven thermometer placed in the oven cavity may differ from the actual set oven temperature in all modes.

### Turning the Preheat Alarm Light On/Off

When the oven reaches its set-temperature, the preheating alarm light flashes 5 times or until the oven door is opened.

You can activate or deactivate the preheating alarm light.

- Press **Settings** repeatedly until  $PrE$  appears in the display.
- Press **1** repeatedly to select the light on/off.
- Press **START** to accept the change.

### Adjusting the Beeper Volume

- Press **Settings** repeatedly until  $BEEP$  appears in the display.
- Press **1** repeatedly to select **Hi**, **Lo** or **Off**.
- Press **START** to accept the change.

#### NOTE

- Adjusting the beeper volume does not affect the preheat alarm volume.

### Selecting Fahrenheit or Celsius

Set the oven temperature display to show either Fahrenheit (°F) or Celsius (°C) units. The oven defaults to Fahrenheit unless changed by the user.

- Press **Settings** repeatedly until  $\downarrow_{RJ}$  appears in the display.
- Press **1** repeatedly to select **F** (Fahrenheit) or **C** (Celsius).
- Press **START** to accept the change.

### Adjusting Cooktop on Alert Volume

- Press **Settings** repeatedly until  $\square \square \square$  appears in the display.
- Press **1** to select **Hi**, **Lo** or **Off**.
- Press **START** to accept the change.

### Turning the Wi-Fi On/Off

You can turn the Wi-Fi transmitter on the PCB on or off.

- Press **Settings** repeatedly until **Wi-Fi** appears in the display.
- Press **1** to turn the Wi-Fi transmitter on/off.

$\square \square \square$

- Press **START** to accept the change.

### Control Lock

The **Control Lock** feature locks the control panel, but does not lock the oven door.

- When the **Control Lock** feature is activated, the cooktop and oven mode do not operate.

- Press and hold **Control Lock** for three seconds.

- 2 The lock melody sounds. **Loc** and the lock icon  appear in the display.
  - 3 To deactivate the **Control Lock** feature, press and hold **Control Lock** for three seconds. The unlock melody sounds and the controls unlock.
- 4 Set the baking time: press **3** and **0** (for 30 minutes).
    - The baking time can be set for any amount of time between 1 minute and 11 hours and 59 minutes
  - 5 Press **Start Time**.
  - 6 Set the start time: Press **4**, **3** and **0** for 4:30.
  - 7 Press **START**. A short beep sounds and **Timed Delay** and the start time appear in the display. The oven begins baking at the set start time.

**NOTE**

- If **Control Lock** is activated, the **Burner On** indicator lights when a cooktop knob is turned even though the cooktop element does not operate.

**Start Time (Delayed Timed Cook)**

The automatic timer of the Delayed Timed Cook function turns the oven on and off at the time you select. This feature can be used with the **Bake**, **Conv. Bake** and **Conv. Roast** modes.

**⚠ CAUTION**

- Use caution with the Delayed Timed Cook features. Use the automatic timer when cooking cured or frozen meats and most fruits and vegetables. Foods that can easily spoil, such as milk, eggs, fish, meat or poultry, should be chilled in the refrigerator first. Even when chilled, they should not stand in the oven for more than 1 hour before cooking begins, and should be removed promptly when cooking is complete. Eating spoiled food can result in sickness from food poisoning.

**Setting a Delayed Timed Cook**

For example, to bake at 300 °F for 30 minutes and delay the start of baking until 4:30, first set the clock for the correct time of day.

- 1 Press the **Bake** button once for the upper or lower oven. 350 °F appears in the display.
- 2 Set the temperature: Press **3**, **0** and **0**.
- 3 Press **Cook Time**. **Timed** flashes in the display. **Bake**, 0:00 and 300 °F appear in the display.

**NOTE**

- To cancel the Delayed Timed Cook function, press **CLEAR/OFF** at any time.
- To change the cooking time, repeat step 3 and 4 and press **START**.
- If the oven clock is set as a 12-hour clock, you can delay the cook time for 12 hours. If the oven clock is set as a 24-hour clock, you can delay the cook time for 24 hours.

The oven will continue to cook for the set amount of time and then turn off automatically. When the cooking time has elapsed:

- **End** and the time of day show in the display.
- The cook end indicator tone sounds every 60 seconds until **CLEAR/OFF** is pressed.

**Cook Time (Timed Cook)**

Set the oven to cook for a specific length of time using the Timed Cook feature. This feature can only be used with the **Bake**, **Conv. Bake**, **Conv. Roast**, **Broil**, **Air Sous-Vide**, **Air Fry**, **FrozenMeal** and **Proof** modes.

**Setting a Timed Cook**

For example, to bake at 300 °F for 30 minutes, first set the clock to the correct time of day.

- 1 Press the **Bake** button once for the upper or lower oven. 350 °F appears in the display.
- 2 Set the temperature. Press **3**, **0** and **0**.

## 28 OPERATION

- 3** Press **Cook Time**. **Timed** flashes in the display. **Bake**, 0:00 and 300 °F appear in the display.
- 4** Set the baking time: press **3** and **0** (for 30 minutes).
- The baking time can be set for any amount of time between 1 minute and 11 hours and 59 minutes
- 5** Press **START**.
- The oven will continue to cook for the set amount of time and then turn off automatically. When the cooking time has elapsed:
- End** and the time of day show in the display.
  - The cook end indicator tone sounds every 60 seconds until **CLEAR/OFF** is pressed.

### Changing the Cook Time during Cooking

For example, to change the cook time to 1 hour and 30 minutes during cooking:

- 1** Press **Cook Time**.
- 2** Change the baking time: press **1, 3, 0**.
- 3** Press **START** to accept the change.

### Minimum & Maximum Default Settings

All of the features listed have a minimum and a maximum time or temperature setting that may be entered into the controls. An entry acceptance beep sounds each time a control button is pressed.

An entry error tone (two short tones) sounds if the entry of the temperature or time is below the minimum or above the maximum setting for the feature.

Feature		Min. Temp. / Time	Max. Temp. / Time	Default
Clock	12 hr.	1:00 hr. / min.	12:59 hr. / min.	-
	24 hr.	0:00 hr. / min.	23:59 hr. / min.	-
Timer	12 hr.	0:01 min. / sec.	11:59 hr. / min.	-
	24 hr.	0:01 min. / sec.	11:59 hr. / min.	-
Cook Time	12 hr.	0:01 hr. / min.	11:59 hr. / min.	-
	24 hr.	0:01 hr. / min.	11:59 hr. / min.	-
Conv.Bake		300 °F / (*275 °F)	550 °F (285 °C)	350 °F (*325 °F) / 12 hr.
Conv.Roast		300 °F / (*275 °F)	550 °F (285 °C)	350 °F (*325 °F) / 12 hr.
Broil		<b>Lo</b> / 0:01 hr. / min.	<b>Hi</b> / 3:00 hr. / min.	<b>Hi</b> / 3 hr.
Bake		170 °F (80 °C)	550 °F (285 °C)	350 °F / 12 hr.
Proof		0:01 hr. / min.	11:59 hr. / min.	12 hr.
Warm		-	-	3 hr.
Pizza		-	-	P1 / 12 hr.
Self Clean		3 hr.	5 hr.	4 hr.
EasyClean		-	-	10 min.

Feature	Min. Temp. / Time	Max. Temp. / Time	Default
Frozen Meal	300 °F (150 °C) / 0:01 hr. / min.	550 °F (285 °C) / 11:59 hr. / min.	400 °F (205 °C)
Air Fry	300 °F (150 °C) / 0:01 hr. / min.	550 °F (285 °C) / 11:59 hr. / min.	400 °F (205 °C)
Air Sous-Vide	100 °F (38 °C) / 0:01 hr. / min.	205 °F (96 °C) / 47:59 hr. / min.	130 °F (54 °C)

**NOTE**

- \* Using auto conversion
- Default cook mode times are without setting a cook time.

## Cooktop

### Before Using the Cooktop

**⚠ WARNING**

- Do not cook on a broken cooktop. If the cooktop is broken, cleaning solutions and spillovers may penetrate the broken cooktop and create a risk of electric shock. Contact a qualified technician immediately.
- Do not place or store items that can melt or catch fire on the glass cooktop, even when it is not being used.
- Never leave hot cookware or utensils near the control panel, as the heat could damage the control panel.
- Turn cookware handles inward so they don't extend over adjacent surface units. This reduces the risk of burns, ignition of flammable materials, and spillage due to unintentional contact with the cookware.
- Some cleaners can produce dangerous fumes if applied to a hot surface.

- Always place the pan in the center of the surface unit you are cooking on. Never leave surface units unattended at high heat settings. Proper contact of cookware to burner also will improve efficiency. Boilovers cause smoking and greasy spills that may catch on fire.
- Clean cooktop with caution. Do not use sponges or a cloth to wipe spills on a hot cooking area. Use a proper metal scraper. If a wet sponge or cloth is used to wipe spills on a hot cooking area, it can cause steam burns. Some cleaners can produce noxious fumes if applied to a hot surface.

**⚠ CAUTION**

- Do not use the glass cooktop surface as a cutting board.
- Choose proper burner size. For smaller pots and pans, use the smaller heating elements. For larger pots and pans, use the larger heating elements. Select pans that have flat bottoms large enough to cover the heating elements. Using undersized pans exposes a portion of the heating element to direct contact and may result in a burn or fire hazard.
- Glazed cookware. Only certain types of glass, glass-ceramic, ceramic, earthenware, or other glazed cookware are suitable for range-top service without breaking due to the sudden change in temperature.
- Never cook directly on the glass. Always use cookware.
- Always turn the surface units off before removing cookware.
- Immediately clean spills on the cooking area to prevent a tough cleaning chore later.
- Do not turn surface units on before placing cookware.
- Do not store heavy items above the cooktop surface that could fall and damage it.
- Do not place aluminum foil or plastic items such as salt and pepper shakers, spoon holders, or plastic wrappings or any other material on the range when it is in use.
- Do not use a steel-wool pad or scrub pad or abrasive cleaning pads. They can scratch the surface.

### Cooking Areas

The cooking areas on your range are identified by permanent circles on the glass cooktop surface.

## 30 OPERATION

For the most efficient cooking, fit the pan size to the element size.

Pans should not extend more than 1/2 to 1-inch beyond the cooking area.

When a control is turned on, a glow can be seen through the glass cooktop surface.

### NOTE

- It is normal for the surface elements to cycle on and off during cooking, even on higher settings. This will happen more frequently if cooking on a lower temperature setting.

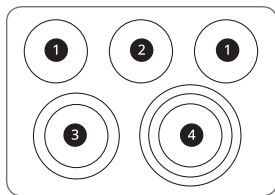

① SINGLE

② WARM ZONE

③ DUAL

④ TRIPLE

### NOTE

- It is normal to see a very faint red ring around the outer edge of a dual or triple element when using it as a single element at a high heat setting. This is only a reflection from the bright glow of the center element and is not a malfunction.

## Using the Cooktop Elements

### ⚠ CAUTION

- Only use cookware and dishes that are safe for oven and cooktop use.
- Always use oven mitts when removing food from the cooktop and oven.
- Do not place sealed containers on the cooktop.
- Do not use plastic wrap to cover food while on the cooktop. Plastic may melt onto the surface and be very difficult to remove.
- Never leave food on the cooktop unattended. Spillovers can cause smoke. Greasy spillovers may catch on fire.
- The surface element may appear to have cooled after it has been turned off. The element may

still be hot and touching the element before it has cooled sufficiently can cause burns.

- Match the size of the cooktop element to the size of the cookware in use. Using a large element for a small pan wastes heating energy, and the exposed surface of the element is a burn or fire hazard.
- Clean the knobs regularly. Soil or foreign objects on the knobs may interfere with the operation of the button.
- Do not apply excessive force when using the buttons and lock functions, or they may be damaged.
- The surfaces of the knobs may be hot after cooking. Allow the knobs to cool sufficiently or put on an oven mitt before touching them.
- The buttons must be properly set to ensure the intended functions of the knobs.

### NOTE

- Hot Surface Indicator
  - The hot surface indicator light glows as long as any surface cooking area is too hot to touch.
  - It remains on after the element is turned off and until the surface has cooled to approximately 150 °F.
- The oven mode knob does not have a button.
- To use the cooktop knobs without pressing in the side button, use the button lock function.
- If removing and reassembling the knob, press and hold the side button while pushing the knob fully onto the shaft.

## Turning on a Single Element

- 1 Press in the side button on the knob ①.
- 2 Push the Single element knob in ②.

**3** Turn the knob in either direction to the desired setting ③.

- The control knob clicks when it is positioned at **OFF**, **HI** and **LO**.

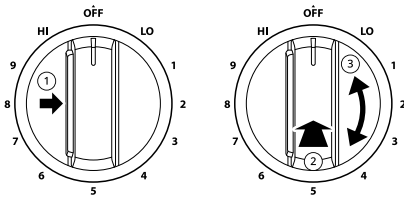

Heating Element	
OFF	ON

**NOTE**

- **HI** is the highest temperature available.
- **LO** is the lowest temperature available.

**Turning on a Dual Element**

There is one dual element located in the left front position. Use the dual element as a dual or single element.

**1** Press in the side button on the knob ①.

**2** Push in the appropriate knob ②.

**3** Turn the knob to use it as a single element or a dual element ③.

- To use it as a single element, turn the knob counterclockwise.
- To use it as a dual element, turn the knob clockwise.

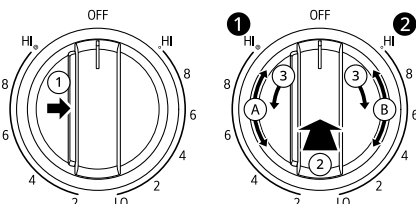

	Icon Type 1	Icon Type 2
① Dual		
② Single		

Heating with inner (smaller) element only	Heating with both elements together
B	A

**Turning on a Triple Element (On Some Models)**

There is one triple element that can be used as either a single, dual or triple element.

**1** Press in the side button on the knob ①.

**2** Push in the appropriate knob ②.

**3** Turn the knob to use it as a single, dual or triple element.

- To use it as a single element, turn the knob counterclockwise.
- To use it as a dual element, turn the knob clockwise to the dual position.
- To use it as a triple element, turn the knob clockwise to the triple position.

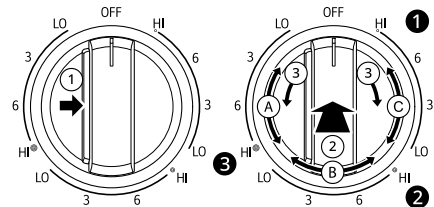

	Icon Type 1	Icon Type 2
① Single		
② Dual		
③ Triple		

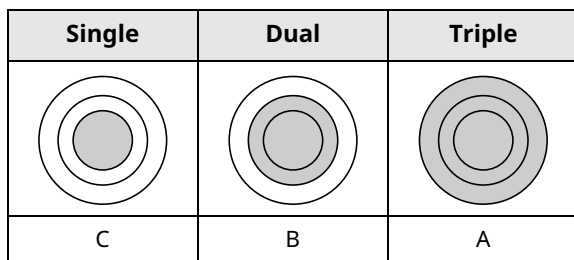

## Turning on the Warm Zone

### NOTE

- The **Warm Zone** will not glow red like the other cooking elements.
- If removing and reassembling the knob, press and hold the side button while pushing the knob fully onto shaft.

### CAUTION

- **FOOD POISON HAZARD** : Bacteria may grow in food at temperatures below 140 °F.
  - Always start with hot food. Do not use the warm setting to heat cold food.
  - Do not use the warm setting for more than 2 hours.

The Warm Zone, located in the back center of the glass surface, will keep hot, cooked food at serving temperature. Use the Warm Zone to keep food warm after it has already been cooked. Attempting to cook uncooked or cold food on the Warm Zone could result in a food-borne illness.

- 1 Press in the side button on the knob ①.
- 2 Push the **Warm Zone** element knob in ②.
- 3 Turn the knob in either direction to the desired setting ③.
  - The control knob clicks when it is positioned at **OFF**, **HI** and **LO**.

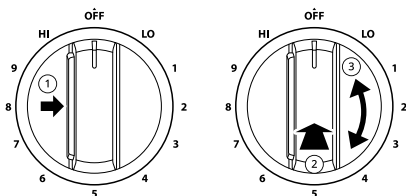

### NOTE

- For best results, food on the warmer should be kept in its container or covered with a lid or aluminum foil to maintain food quality.

## Using the Knob Lock

You can adjust the Knob Lock on each cooktop knob so you don't have to press the button in to use the knob. Remove and adjust one knob at a time.

- 1 Make sure the knob is in the **OFF** position and pull it straight off the stem.
- 2 On the back of the knob ring, rotate the black tab to the **2 Step** or **3 Step** position.
  - If you slide the tab to the **2 Step** ① position, the knob can be used without pressing in the button.
  - If you slide the tab to the **3 Step** ② position, you must press in the button to use the knob.

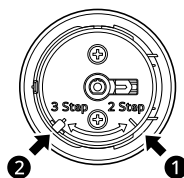

- 3 Once the Knob Lock is adjusted as desired, reinstall the knob. To reinstall, hold the knob with the **OFF** label at the top and slide the knob directly onto the stem.

### NOTE

- The black tab must be aligned with the **2 Step** or **3 Step** mark to ensure proper operation of the knob and button.

## The Recommended Surface Cooking Setting

Setting	Recommended Use
8.5-Hi	<ul style="list-style-type: none"> <li>• Bring liquid to a boil</li> <li>• Start cooking</li> </ul>

Setting	Recommended Use
5.5-8.0	<ul style="list-style-type: none"> <li>• Hold a rapid boil, frying, deep fat fry</li> <li>• Quickly brown or sear food</li> </ul>
3.5-5.0	<ul style="list-style-type: none"> <li>• Maintain a slow boil</li> <li>• Fry or saute foods</li> <li>• Cook soups, sauces and gravies</li> </ul>
2.2-3.0	<ul style="list-style-type: none"> <li>• Stew or steam food</li> <li>• Simmer</li> </ul>
Lo-2.0	<ul style="list-style-type: none"> <li>• Keep food warm</li> <li>• Melt chocolate or butter</li> <li>• Simmer</li> </ul>

## Using the Proper Cookware

The size and type of cookware will influence the settings needed for the best cooking results. Be sure to follow the recommendations for using proper cookware.

### NOTE

- Match the size of the cookware to the amount of food being cooked to save energy when heating. Heating 1/2 quart of water requires more energy in a 3-quart pot than in a 1-quart pot.

Cookware should have flat bottoms that make good contact with the entire surface heating element. Check for flatness by placing a ruler across the bottom of the cookware. The ruler should touch the cookware across the entire bottom, with no gaps.

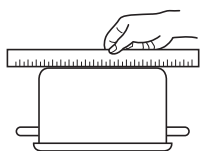

### Cookware Recommendations

- Flat bottom and straight sides
- Heavy-gauge pans
- Pan sizes that match the amount of food to be prepared and the size of the surface element
- Weight of handle does not tilt pan. Pan is well balanced
- Tight-fitting lids
- Flat bottom woks

### Cookware should not

- have a curved or warped bottom.



- be smaller or larger than the surface burner.



- have a heavy handle that tilts the pan.



- be a wok with a ring stand.

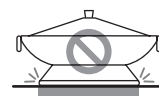

- have loose or broken handles.

- have loose-fitting lids.

### NOTE

- Do not use pans less than 7 inches in diameter on the front elements.
- Do not use foil or foil-type containers. Foil may melt onto the glass. Do not use the cooktop if metal has melted on it. Call an authorized LG Service Center.

### Choosing Cookware

The cookware material determines how evenly and quickly heat is transferred from the surface element to the pan bottom. The most popular materials available are:

- **Aluminum** - Excellent heat conductor. Some types of food will cause it to darken (anodized aluminum cookware resists staining and pitting). If aluminum pans slide across the ceramic cooktop, they may leave metal marks which will resemble scratches. Remove these marks immediately.
- **Copper** - Excellent heat conductor but discolors easily. May leave metal marks on glass-ceramic (see Aluminum above).
- **Stainless steel** - Slow heat conductor with uneven cooking results. Is durable, easy to clean and resists staining.
- **Cast iron** - A poor heat conductor but retains heat very well. Cooks evenly once cooking

temperature is reached. Not recommended for use on ceramic cooktops.

- **Porcelain-enamel on metal** - Heating characteristics will vary depending on base material. Porcelain-enamel coating must be smooth to avoid scratching ceramic cooktops.
- **Glass** - Slow heat conductor. Not recommended for ceramic cooktop surfaces because it may scratch the glass.

### Home Canning Tips

Be sure that the canner is centered over the surface element and is flat on the bottom.

- The base must not be more than 1 inch larger than the element. Use of water bath canners with rippled bottoms may extend the time required to bring the water to a boil and may damage the cooktop.
- Some canners are designed with smaller bases for use on smooth surfaces.
- Use the high heat setting only until the water comes to a boil or pressure is reached in the canner.
- Reduce to the lowest heat setting that maintains the boil, or pressure. If the heat is not turned down, the cooktop may be damaged.

## Oven

### Before Using the Oven

---

#### NOTE

- Because the oven temperature cycles, an oven thermometer placed in the oven cavity may not show the same temperature that is set on the oven.
  - It is normal for the convection fan to run while preheating during a regular bake cycle.
  - The convection fan motor may run periodically during a regular bake cycle.
  - The fan turns off if the door is left open during baking. The fan turns back on automatically once the door is closed.
  - Avoid opening the oven door more than necessary during use. This helps the oven maintain temperature, prevents unnecessary heat loss, and saves on energy use.
- 

### Using Oven Racks

The racks have a turned-up back edge that prevents them from being pulled out of the oven cavity.

---

#### CAUTION

- Replace oven racks before turning the oven on to prevent burns.
  - Do not cover the racks with aluminum foil, or any other material, or place anything on the bottom of the oven. Doing so will result in poor baking and may damage the oven bottom.
  - Only arrange oven racks when the oven is cool.
  - Do not place objects heavier than 33 lb (15 kg) on the racks. Do not place heavy objects on the corners of the racks. Doing so can damage the racks or cause them to come off the rails, which may result in injury.
- 

### Removing Racks

- 1 Pull the rack straight out until it stops.
- 2 Lift up the front of the rack and pull it out.

### Replacing Racks

- 1 Place the end of the rack on the support.
- 2 Tilt the front end up and push the rack in.

### Bake

Bake is used to prepare foods such as pastries, breads and casseroles.

The oven can be programmed to bake at any temperature from 170 °F (80 °C) to 550 °F (285 °C). The default temperature is 350 °F (175 °C).

### Setting the Bake Function

(For example, to bake at 375 °F)

- 1 Press the **Bake** button once for the upper or lower oven.
- 2 Set the oven temperature: Press **3**, **7** and **5**.

- Press **START**. The oven starts to preheat.

#### NOTE

- As the oven preheats, the temperature is displayed and rises in 5-degree increments. Once the oven reaches the set temperature, a tone sounds and the oven light blinks on and off.

- When cooking is complete, press **CLEAR/OFF**

- Remove the food from the oven.

### Changing the Temperature during Cooking

- Press **Bake**.
- Touch the number buttons to change the set temperature.
- Press **START**.

#### NOTE

- It is normal for the convection fan to operate periodically throughout a normal bake cycle in the oven. This is to ensure even baking results.

### Baking Tips

- Baking time and temperature will vary depending on the characteristics, size, and shape of the baking pan used.
- Check for food doneness at the minimum recipe time.
- Use metal bakeware (with or without a nonstick finish), heatproof glass-ceramic, ceramic or other bakeware recommended for oven use.
- Dark metal pans or nonstick coatings will cook food faster with more browning. Insulated bakeware will slightly lengthen the cooking time for most foods.
- The oven bottom has a porcelain-enamel finish. To make cleaning easier, protect the oven bottom from excessive spillovers by placing a cookie sheet on the rack below the rack you are cooking on. This is particularly important when baking a fruit pie or other foods with a high acid content. Hot fruit fillings or other foods that are highly acidic may cause pitting and damage to

the porcelain-enamel surface and should be wiped up immediately.

### Convection Mode (Lower Oven Only)

The convection system uses a fan to circulate the heat evenly within the oven. Improved heat distribution allows for even cooking and excellent results while cooking with single or multiple racks.

#### Setting the Convection Function

(For example, cooking at 375 °F)

- Press the **Conv. Bake** or **Conv. Roast** button once. The display flashes 350°F.
- Set the oven temperature: Press **3**, **7** and **5**.
- Press **START**. The display shows **Conv. Bake** or **Conv. Roast** and the oven temperature starting at 100 °F.
  - As the oven preheats, the display shows increasing temperatures in 5-degree increments. Once the oven reaches the set adjusted temperature, a tone sounds and the oven light flashes on and off. The display shows the auto-converted oven temperature, 350 °F and the fan icon.
- When cooking has finished or to cancel, press **CLEAR/OFF**.

#### NOTE

- The oven fan runs while convection baking. The fan stops when the door is open. In some cases, the fan may shut off during a convection bake cycle.

### Tips for Convection Baking

- Use Convection Bake for faster and more even multiple-rack cooking of pastries, cookies, muffins, biscuits, and breads of all kinds.
- Bake cookies and biscuits on pans with no sides or very low sides to allow heated air to circulate around the food. Food baked on pans with a dark finish will cook faster.
- When using Convection Bake, place the oven racks in positions suggested in the charts in this manual.

## 36 OPERATION

- Multiple oven rack cooking may slightly increase cook times for some foods.
- Cakes, cookies and muffins have better results when using multiple racks.

### Tips for Convection Roasting

The Convection Roast feature is designed to give optimum roasting performance. Convection Roast combines cooking with the convection fan to roast meats and poultry. The heated air circulates around the food from all sides, sealing in juices and flavors. Foods are crispy brown on the outside while staying moist on the inside. Convection roasting is especially good for large tender cuts of meat, uncovered.

Use a broiler pan and grid when preparing meats for convection roasting. The broiler pan catches grease spills and the grid helps prevent grease splatters.

- 1 Place the oven rack in the recommended position.

- 2 Place the grid in the broiler pan.
- 3 Place the broiler pan on the oven rack.

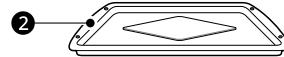
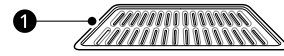

- 1 Grid (sold separately)
- 2 Broiler pan (sold separately)

### ⚠ CAUTION



- Do not use a broiler pan without a grid.
- Do not cover the grid with aluminum foil.
- Position food (fat side up) on the grid.

## Recommended Baking and Roasting Guide

If cooking on multiple racks, place the oven racks in the positions shown. Multiple-rack cooking saves time and energy. Whenever possible, cook foods requiring the same cooking temperature together in one oven.

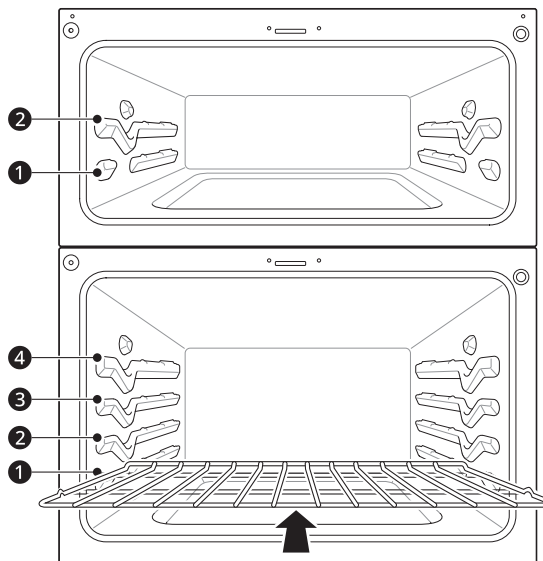
### Rack and Pan Placement

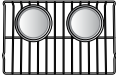

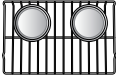
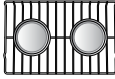
Multiple rack baking	
	
Rack (Position 1)	Rack (Position 3)
Single rack baking	
	
Rack (Upper Oven)	Rack (Lower Oven)

## Baking Rack Guide

Food		Rack Position	
		Upper Oven	Lower Oven
Cakes	Layer cakes	1	1
	Bundt cakes	1	1
	Angle Food Cake	1	1
Cookies	Sugar cookies	2	1
	Chocolate chips	2	2
	Brownies	2	3
Pizza	Fresh	2	2
	Frozen Thin	2	1
	Frozen Rising Crust	2	2
Pastry Crust	From scratch	1	2
	Refrigerated	1	2
Breads	Biscuit, canned	2	3
	Biscuit, from scratch	2	2
	Muffins	2	2
Desserts	Fruit crisps and cobblers, from scratch	1	2 or 3
	Pies, from scratch, 2-crust fruit	1	2
Custards	Cheesecake	1	1
	Crème Brulee	2	3
Souffles	Sweet or Savory	1	1
Casseroles	Fresh	1	2
	Frozen	1	2

Recommendation: Cook Casseroles and all ready-to-serve foods to 165 °F Internal Temperature. Extend the cooking time as needed to your desired level of doneness and browning. For upper oven, use pizza mode with a pizza pan and rotate the pizza halfway through cooking. Extend cooking time as needed to meet the desired level of doneness.

## Roasting Rack Guide

Food			Rack Position
			Lower Oven
Beef	Rib	Rare	1
		Medium	1
		Well done	1
Beef	Boneless rib, top sirloin	Rare	1
		Medium	1
		Well done	1
Beef	Beef tenderloin	Rare	1
		Medium	1
Pork	Rib		1
	Bone-in, sirloin		1
	Ham, cooked		1
Poultry	Whole chicken		1
	Chicken pieces		2
	Turkey		1

### Proof (Lower Oven Only)

This feature maintains a warm oven for rising yeast-leavened products before baking. (Set temperature: 92 °F)

#### Setting the Proof Function

- 1 Use rack position ② or ③ for proofing.

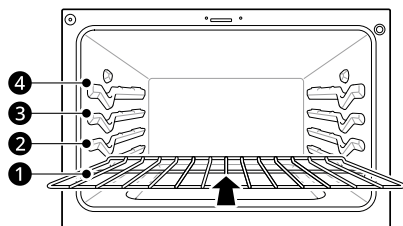

- 2 Press the **Proof** button once.
- 3 Press **START**.
- 4 Press **Lower CLEAR/OFF** when proofing is finished.

#### NOTE

- To avoid lowering the oven temperature and lengthening proofing time, do not open the oven door unnecessarily. Check bread products early to avoid over proofing.
- Do not use the Proofing mode for warming food or keeping food hot. The proofing oven temperature is not hot enough to keep foods at safe temperatures. Use the Warm feature to keep food warm. Proofing does not operate when the oven is above 125 °F. **Hot** shows in the display.
- It is normal for the fan to operate during the Proof function.
- In the Proof mode, it is normal for **Hot** to appear briefly in the display as the oven burner operates.

### Pizza (Upper Oven Only)

This function is specially designed for cooking pizza. It heats from both the top and bottom to brown food more evenly.

This system is designed to give the optimum cooking performance for pizza by automatically selecting a combination of the broil and bake heating systems.

When using this function, there is no need to preheat the oven prior to cooking.

## Setting the Oven for Pizza

- 1** Press **Pizza** once. **P1** appears in the display. Press **1**, **2** or **3** to toggle between **P1**, **P2**, and **P3**. Select the desired option. (See Pizza Chart below.)
- 2** Press **START**.

- 3** Place pizza in the oven, close the door and set the timer following the suggestions in the chart.
- 4** When cooking is complete, press **Upper CLEAR/OFF**.
- 5** Remove the food from the oven.

### NOTE

- Rotate the pizza halfway through cooking. Extend the cooking time as needed to meet the desired level of doneness.

## Pizza Chart

Upper Oven

Display Mode	Item	Rack position	Minutes <sup>†</sup>
P1	Frozen pizza, Regular crust	2	13-18
P2	Frozen pizza, Rising crust	2	18-23
P3	Fresh Pizza	2	13-18

<sup>†</sup> This is the recommended cooking time.

This chart is based on one 12" pizza, and is only for reference. Adjust cook time according to size of pizza and preference.

## Warm

This function maintains an oven temperature of 170 °F. It will keep cooked food warm for serving up to 3 hours after cooking has finished. The Warm function may be used without any other cooking operations or can be used after cooking has finished using Timed Cook or Delayed Timed Cook.

## Setting the Warm Function

- 1** Press the **Warm** button once for the upper or lower oven.
- 2** Press **START**.
- 3** Press **CLEAR/OFF** at any time to cancel.

### NOTE

- The Warm function is intended to keep food warm. Do not use it to cool food down.
- It is normal for the fan to operate during the Warm function.
- The Warm function will be maintained up to 3 hours unless you press **CLEAR/OFF**.

## Setting the Warm Function after a Timed Cook

- 1** Select the **Bake**, **Broil**, **Conv. Bake**, **Conv. Roast**, **Air Fry**, or **Frozen Meal** cooking mode.
- 2** Set the temperature.

## 40 OPERATION

---

- 3 Press **Cook Time** and enter the cook time using the number buttons.
- 4 Press the **Warm** button.
- 5 To cancel the Warm function, press **CLEAR/OFF** button.

### NOTE

- You can also activate the Warm function while operating some cook modes.
  - The Warm function will be maintained for up to 3 hours unless you press the **CLEAR/OFF** button.
- 

## Broil

The Broil function uses intense heat from the upper heating element to cook food. Broiling works best for tender cuts of meat, fish, and thinly cut vegetables.

Some models may feature a hybrid broiler consisting of an inner broiler that utilizes a carbon heating element which provides instantaneous heat, and a traditional outer broiling element. During normal broiler operation, it is normal for either element to cycle off intermittently.

### CAUTION

- Do not use a broiler pan without a grid. Oil can cause a grease fire.
  - Do not cover the grid and broiler pan with aluminum foil. Doing so will cause a fire.
  - Always use a broiler pan and grid for excess fat and grease drainage. This will help to reduce splatter, smoke, and flare-ups.
  - When using your broiler, the temperature inside the oven will be extremely high. Take care to avoid possible burns by:
    - Keeping the door closed when broiling
    - Always wearing oven mitts when inserting or removing food items
- 

### NOTE

- This range is designed for closed-door broiling. Close the door to set the Broil function. If the door is open, the Broil function cannot be set and "door" appears on the display. Close the door and reset the Broil function. If the door is opened during broiling, the broil burner turns

off after five seconds. The broiler turns back on automatically once the door is closed.

---

## Setting the Oven to Broil

- 1 Press the **Broil** button once for the upper or lower oven.
  - Press **1** to set **Hi** or press **2** to set **Lo**.
- 2 Press **START**. The oven begins to heat.
- 3 Let the oven preheat for approximately five minutes before cooking the food if using **Broil**.
- 4 Press **CLEAR/OFF** to cancel at any time or when cooking is complete.

## Tips for Reducing Smoke

Due to the intense heat associated with broiling, it is normal to experience smoke during the cooking process. This smoke is a natural byproduct of searing and should not cause you to worry. If you are experiencing more smoke than you are comfortable with, use the following tips to reduce the amount of smoke in your oven.

- Always use a broiler pan. Do not use saute pans or regular baking sheets for safety reasons.
- The broiler pan should always be thoroughly cleaned and at room temperature at the beginning of cooking.
- Always run your cooktop ventilation system or vent hood during broiling.
- Keep the interior of your oven as clean as possible. Leftover debris from prior meals can burn or catch fire.
- Avoid fatty marinades and sugary glazes. Both of these will increase the amount of smoke you experience. If you would like to use a glaze, apply it at the very end of cooking.
- If you are experiencing significant smoke with any food item, consider:
  - Lowering the broiler to the **Lo** setting.
  - Lowering the rack position to cook the food farther away from the broiler.
  - Using the **Hi** broil setting to achieve the level of searing you desire, and then either switching to the **Lo** broil setting, or switching to the Bake function.

- As a rule, fattier cuts of meat and fish will produce more smoke than leaner items.
- Adhere to the guidelines in the **Recommended Broiling Guide** section whenever possible.

## Recommended Broiling Guide

The size, weight, thickness, starting temperature, and your preference of doneness will affect broiling times.

This guide is based on meats at refrigerator temperature. For best results when broiling, use a pan designed for broiling.

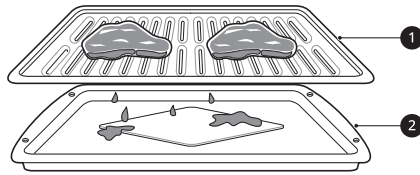

① Grid (sold separately)

② Broiler pan (sold separately)

### Upper Oven

Food	Quantity and/or Thickness	Rack Position	First Side (min.)	Second Side (min.)	Comments
<b>Ground Beef</b> Well done	1 lb. (4 patties) $\frac{1}{2}$ to $\frac{3}{4}$ " thick	2	3-6	2-5	Space evenly. For 1-4 patties, use Broil in upper oven. For more than 4 patties, use Broil in lower oven.
<b>Beef Steaks</b>	1" thick 1 to $1\frac{1}{2}$ lbs.	Rare	2	3-4	Steaks less than 1" thick cook through before browning. Pan frying is recommended. Slash fat.
		Medium	2	4-5	
		Well done	2	5-6	
	$1\frac{1}{2}$ " thick 2 to $2\frac{1}{2}$ lbs.	Rare	1	8	
		Medium	1	9	
		Well done	1	10	
<b>Chicken</b>	1 whole, 2 to $2\frac{1}{2}$ lbs., split lengthwise	1	10	4-6	Broil skin-side-down first.
	2 Breasts	1	8-10	3-5	
<b>Lobster Tails</b>	2-4 10 to 12 oz. each				Cut through back of shell. Spread open. Brush with melted butter before broiling and halfway through broiling time.
<b>Fish Fillets</b>	$\frac{1}{4}$ to $\frac{1}{2}$ " thick	2	5	2-3	Handle and turn very carefully. Brush with lemon butter before and during cooking, if desired.

Food	Quantity and/or Thickness	Rack Position	First Side (min.)	Second Side (min.)	Comments	
<b>Ham Slices</b> (precooked)	1/2" thick	2	4-5	2-3	Increase time 5 to 10 minutes per side for 1 1/2" thick or home-cured ham.	
<b>Pork Chops</b> Well done	1 (1/2" thick)	2	7	3-5		
	2 (1" thick) about 1lb.	1	7	2-4		
<b>Lamb Chops</b>	2 (1" thick) about 10 to 12 oz.	Medium	2	4-5	2-3	
		Well done	2	5-6	3-4	
	2 (1 1/2" thick) about 1lb.	Medium	1	9	4-5	
		Well done	1	10	5-6	
<b>Salmon Steaks</b>	2 (1" thick)	2	6	3-5	Grease pan. Brush steaks with melted butter.	
	4 (1" thick) about 1 lb.	1	7	3-5		
<b>Bread</b>	1/2" thick	1	1-3	0.5-3		

**Lower Oven**

Food	Quantity and/or Thickness	Rack Position	First Side (min.)	Second Side (min.)	Comments	
<b>Ground Beef</b> Well done	1 lb. (4 patties) 1/2 to 3/4" thick	4	4-7	3-5	Space evenly. Up to 9 patties may be broiled at once.	
<b>Beef Steaks</b>	1" thick 1 to 1 1/2 lbs.	Rare	4	4-5	2-3	Steaks less than 1" thick cook through before browning. Pan frying is recommended. Slash fat.
		Medium	4	4-7	3-4	
		Well done	4	6	4-5	
	1 1/2" thick 2 to 2 1/2 lbs.	Rare	3	10	4	
		Medium	3	10-12	5-6	
		Well done	3	12	6-8	
<b>Chicken</b>	1 whole, 2 to 2 1/2 lbs., split lengthwise	3	14-16	4-6	Broil skin-side-down first.	
	2 Breasts	3	8-9	3-5		
<b>Lobster Tails</b>	2-4 10 to 12 oz. each	2	14	Do not turn over	Cut through back of shell. Spread open. Brush with melted butter before broiling and halfway through broiling time.	

Food	Quantity and/or Thickness		Rack Position	First Side (min.)	Second Side (min.)	Comments
<b>Fish Fillets</b>	1/4 to 1/2" thick		4	6	3-4	Handle and turn very carefully. Brush with lemon butter before and during cooking, if desired.
<b>Ham Slices</b> (precooked)	1/2" thick		4	6-8	2-4	Increase time 5 to 10 minutes per side for 1 1/2" thick or home-cured ham.
<b>Pork Chops</b> Well done	1 (1/2" thick)		4	5-6	2-4	
	2 (1" thick) about 1lb.		3	9-10	4-6	
<b>Lamb Chops</b>	2 (1" thick) about 10 to 12 oz.	Medium	4	6	3-4	
		Well done	4	8	4-5	
	2 (1 1/2" thick) about 1lb.	Medium	3	10	5-6	
		Well done	3	12	6-8	
<b>Salmon Steaks</b>	2 (1" thick)		4	8	4-6	Grease pan. Brush steaks with melted butter.
	4 (1" thick) about 1 lb.		3	9	4-6	
<b>Bread</b>	1/2" thick		4	0.5-1	0.5-1	

- For best performance, center food on rack when using Broil.
- This guide is only for reference. Adjust cook time according to your preference.

## NOTE

- The USDA advises that consuming raw or undercooked fish, meat, or poultry can increase your risk of food-borne illness.
- The USDA has indicated the following as safe minimum internal temperatures for consumption:
  - Ground beef: 160 °F (71.1 °C)
  - Poultry: 165 °F (73.9 °C)
  - Beef, veal, pork, or lamb: 145 °F (62.8 °C)
  - Fish / Seafood: 145 °F (62.8 °C)

## Tips for Broiling

- **Beef**
  - Steaks and chops should always be allowed to rest for five minutes before being cut into and eaten. This allows the heat to distribute evenly through the food and creates a more tender and juicy result.
  - Pieces of meat that are thicker than two inches should be removed from the refrigerator 30 minutes prior to cooking. This will help them cook more quickly and evenly, and will produce less smoke when broiling. Cooking times will likely be shorter than the times indicated in the Broiling Chart.
  - For bone-in steaks or chops that have been frenched (all meat removed from around the bone), wrap the exposed sections of bone in foil to reduce burning.

### • Seafood

- When broiling skin-on fish, always use the **Lo** broil setting and always broil the skin side last.
- Seafood is best consumed immediately after cooking. Allowing seafood to rest after cooking can cause the food to dry out.
- It is a good idea to rub a thin coating of oil on the surface of the broiling pan before cooking to reduce sticking, especially with fish and seafood. You can also use a light coating of non-stick pan spray.

### • Vegetables

- Toss your vegetables lightly in oil before cooking to improve browning.

## Frozen Meal (Lower Oven Only)

The Frozen Meal function is specially designed for cooking frozen prepared meals.

No preheating is required when using the Frozen Meal mode. For best results with frozen pizza, cook food on a single rack placed in position ② or ③ at 400 °F.

### Setting the Frozen Meal Function

- 1 Press the **Frozen Meal** button once. **Frozen** appears in the display.
- 2 Set the cook temperature using the number buttons. (Range: 300 °F ~ 550 °F)
- 3 Press **START**. The Frozen Meal function starts operation.
- 4 Press **Lower CLEAR/OFF** to cancel at any time or when cooking is complete.

#### NOTE

- To cancel the Frozen Meal function during use, press **Lower CLEAR/OFF** at any time.

## Air Sous-Vide (Lower Oven Only)

Air Sous-Vide cooking uses air to cook foods "low and slow." Use it to cook meat, fish, seafood, poultry or vegetables. Food must be vacuum packed in pouches before cooking.

- It is not necessary to preheat the oven when using Air Sous-Vide.
- Refer to the cooking guide for recommended Air Sous-Vide settings.

## Benefits of Air Sous-Vide

The lower temperatures and long cooking times used in Air Sous-Vide cooking provide many benefits.

- Healthier
  - Compared to other cooking methods, Air Sous-Vide retains most of the original nutrients in food.
- Safe and Convenient
  - The long cooking times used in Air Sous-Vide cooking allow food to be pasteurized. Because food is vacuum packed before cooking, the unopened pouches can be quickly chilled in an ice bath and stored in the freezer or refrigerator after cooking.
- Crisp and Moist Results
  - The fine temperature control of Air Sous-Vide cooking is an excellent way to achieve the perfect texture when cooking meat and poultry. The low temperatures used retain more of the moisture in food than conventional cooking methods. After cooking, a final sear in a frying pan adds the perfect crisp finish.

### Setting Air Sous-Vide Mode

- 1 Place the heavy duty rack in position 1 and place the sealed food bag on it.
- 2 Press the **Air Sous-Vide** button once.
- 3 Set the desired oven temperature. (Range: 100 °F ~ 205 °F)
- 4 Press **START**.
- 5 Once cooking is finished, allow the oven to cool completely.

## Recommended Air Sous-Vide Guide

Food	Quantity	Rack Position	Temp. (°F)	Time		
				Min.	Target	Max.
Beef Steaks	1" thick 14 - 17 oz.	2	135	-	2.5 hr.	3 hr.
Chicken	Breasts	4 - 6 oz.	150	-	2 hr.	3 hr.
	Thighs (bone in)	6 - 8 oz.	155	-	4 hr.	6 hr.
Salmon	1" thick 5 - 7 oz.	2	140	-	2 hr.	2.5 hr.
Vegetables	Asparagus	2.8 oz. / 6 ea 5.6 oz. / 12 ea	185	20 min.	30 min.	45 min.
	Potatoes	1/2" diced up to 36 oz.	200	-	2 hr.	-
	Carrots	1/2" diced up to 18 oz.	200	1.5 hr.	2 hr.	3 hr.

### Air Fry (Lower Oven Only)

This feature automatically increases the entered temperature by 50°F for optimal performance when using Air Fry.

The Air Fry function is specially designed for oil-free frying.

### Setting the Air Fry Function

- 1 Press the **Air Fry** button once. 400°F appears in the display.
- 2 Set the oven temperature. (Range: 300°F ~ 550°F)
- 3 Press **START**.
- 4 Press **Lower CLEAR/OFF** to cancel at any time or when cooking is complete.

#### NOTE

- No preheating is required when using the Air Fry mode.
- If cooking multiple batches, the later batches may take less time to cook.
- Wet batters and coatings will not crisp or set when using the Air Fry mode.

### Tips for Air Fry

- For best results, use the air fry tray sold separately.
- The mesh section of the air fry tray can be cleaned in a dishwasher.

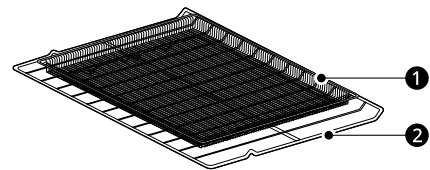

① Air Fry Tray (Sold separately)

② Standard Rack

- If you don't have the air fry tray, place food on a wire rack inside a foil-lined broiler pan.

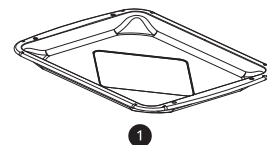

① Broiler Pan (Sold separately)

- For best results, cook food on a single rack placed in positions suggested in the chart in this manual.
- Spread the food out evenly in a single layer.
- Use either the optional air fry tray available from LG or a dark baking tray with no sides or short

sides that does not cover the entire rack. This allows for better air circulation.

- If desired, spray the baking tray or air fry tray with a pan spray. Use an oil that can be heated to a high temperature before smoking, such as avocado, grapeseed, peanut or sunflower oil.
- Place a foil-lined baking tray on a rack in position 1 to catch the oil falling from the food. For high-fat foods like chicken wings, add a few sheets of parchment paper to absorb the fat.
- Check food often and shake it or turn it over for crisper results.
- Prepared frozen foods may cook faster with the Air Fry mode than stated on the package. Reduce the cooking time by about 20 percent, check food early, and adjust cooking time as needed.
- Use a food thermometer to make sure food has reached a safe temperature for consumption. Eating undercooked meats can increase your risk of food-borne illness.
- For the crispiest results, dredge fresh chicken wings or tenders in seasoned flour. Use 1/3 cup flour for 2 pounds of chicken.

### Recommendations When Air Frying High-Fat Foods

Food high in fat will smoke when using the Air Fry mode. For best results, follow these recommendations when air frying foods that are high in fat, such as chicken wings, bacon, sausage, hot dogs, turkey legs, lamb chops, ribs, pork loin, duck breasts, or some plant-based proteins.

### Recommended Air Frying Guide

- Arrange food evenly in a single layer.
- Put a foil-lined baking pan on a rack in position 1 to catch drips. If needed, add parchment paper to absorb oil and reduce smoking.
- Flip food over during cooking to avoid burning it.

† High-fat items may produce more smoke when cooked using Air Fry. For less smoke, cook using Convection Roast mode.

### CAUTION

- Never cover slots, holes, or passages in the oven bottom or cover entire racks with materials such as aluminum foil. Doing so blocks airflow through the oven and can result in carbon monoxide poisoning. Aluminum foil can also trap heat, causing a fire hazard or poor oven performance.
- Clean the grease filters on your exhaust hood regularly.
- Turn on your exhaust hood at a high fan setting before you start Air Fry and leave it on for 15 minutes after you're done.
- Open a window or sliding glass door, if possible, to make sure the kitchen is well-ventilated.
- Keep the oven free from grease buildup. Wipe down the interior of the oven before and after air frying (once the oven has cooled).
- Run oven cleaning cycles (**EasyClean** or **SelfClean**) regularly, depending on how often and what types of food you **Air Fry**.
- Avoid opening the oven door more than necessary to help maintain the oven temperature, prevent heat loss, and save energy.
- Air-frying fresh chicken pieces such as wings or drumsticks with the skin left on can produce smoke as the fat renders at high temperatures. If the smoke is excessive, use the Convection Roast mode instead of Air Fry.

Recommended Items	Quantity (oz.)	Temp. (°F)	Rack Position	Time	Guide
<b>POTATOES-Frozen</b>					
Frozen French Fries (Shoestring)	20	425	3	15-25	
Frozen French Fries (Crinkle cut, 3/8" or 10 mm)	35	425	3	20-30	

Recommended Items	Quantity (oz.)	Temp. (°F)	Rack Position	Time	Guide
Frozen Sweet Potato Fries	25	425	3	15-30	
Frozen Tater Tots	50	450	3	20-30	
Frozen Hash Browns	40	450	3	25-35	
<b>POTATOES-Fresh/Homemade</b>					
Homemade French Fries (3/8" x 3/8" or 10 x 10 mm)	25	450	3	25-35	Cut the potatoes and soak for 30 minutes in hot tap water. Drain and pat dry. Brush or lightly spray with 3 tbsp. of oil. Add salt and pepper to taste.
Homemade Potato Wedges	60	450	3	30-40	
<b>CHICKEN-Frozen</b>					
Frozen Chicken Nuggets, Crispy	30	425	3	15-25	
Frozen Chicken Strips	35	425	3	25-35	
Frozen Hot Wings, Bone-in	50	425	3	25-35	
<b>CHICKEN-Fresh, Skin on</b>					
Fresh Chicken Wings <sup>†</sup>	40	450	3	25-35	Brush or lightly spray with 1 tbsp. of oil. Add salt and pepper to taste.
Fresh Chicken Drumsticks <sup>†</sup>	70	450	3	30-40	
Thighs	40	450	3	30-35	
Breasts	40	450	3	30-35	
<b>OTHER</b>					
Frozen Onion Rings, Breaded	20	400	3	20-30	
Frozen Spring Rolls (0.7 oz. each)	45	425	3	20-30	
Thin Sausage <sup>†</sup> (2.5 oz. each, diameter 0.8")	90	400	3	20-30	
Frozen Coconut Shrimp	25	425	3	20-30	Brush or lightly spray the surface of food with oil.
Fresh Scallops on the half shell (35 oz.)	35	425	3	20-30	Melt 4 tbsp. of butter and brush on scallops. Mix 1/2 cup bread crumbs, 1 tbsp., minced garlic, 1/4 cup grated parmesan cheese and season to taste. Sprinkle mixture over scallops.
Fresh Shrimp	50	425	3	20-30	

Recommended Items	Quantity (oz.)	Temp. (°F)	Rack Position	Time	Guide
Mixed Vegetables	35	425	3	20-30	Brush or lightly spray with 4 tbsp. of olive oil. Add salt and pepper to taste.

## Remote Start

This feature starts preheating and maintains the temperature for up to 12 hours (including preheating time). The appliance must be connected to a home Wi-Fi network to use Remote Start. Once Remote Start is selected on the appliance, you can start or stop it remotely using the LG ThinQ smartphone app. Follow the instructions in the Smart Functions section to connect the appliance to the network.

### Setting Remote Start

- 1 Open the oven door to make sure the oven is ready for pre-heating. Close the oven door.
- 2 Press the **Remote Start** button once.
- 3 When **ON** appears in the display, the Remote Start function is ready to use.
- 4 Follow the instructions in the smartphone app to set the cook mode, temperature, and run time (preheating time plus holding time).

#### NOTE

- Remote Start may not start if
  - The appliance is not connected to the Wi-Fi network and/or **OFF** appears in the display.
  - Remote Start is not set up in the smartphone app.
  - The oven door is open. If the oven door is open, a short beep sounds.

## Using the Sabbath Mode

Sabbath mode is typically used on the Jewish Sabbath and Holidays. While the oven is in Sabbath mode, the temperature cannot be changed and the timer, light, and alarm functions are disabled. When the Sabbath mode is activated, the oven does not turn off until the Sabbath mode is

deactivated. In Sabbath mode, all function buttons are inactive. 5b will appear in the display. On double ovens, either oven or both ovens can be put in Sabbath mode.

- 1 Press the **Bake** button once.
- 2 Set the desired temperature and cook time.
- 3 Press **START**.
- 4 If using both ovens, set the temperature and cook time for the second oven before pressing **Settings**.
- 5 Press and hold the **Settings** button for 3 seconds. 5b appears in the display when the Sabbath mode is activated.
 

- 6 To stop the Sabbath mode, press and hold the **Settings** button for 3 seconds. To cancel the Bake function, press **CLEAR/OFF** at any time.

#### NOTE

- If a cook time is set, the oven turns off automatically at the end of the cook time, without chiming. The oven remains in Sabbath mode, but is turned off.
- If no cook time is set, the oven will not automatically turn off.
- After a power failure, the display will turn back on in Sabbath mode, but the oven will be off.
- Always close the oven door before engaging Sabbath Mode.

# SMART FUNCTIONS

## LG ThinQ Application

This feature is only available on models with Wi-Fi.

The **LG ThinQ** application allows you to communicate with the appliance using a smartphone.

### LG ThinQ Application Features

#### • Product Upgrades

- On models with the **LG UP** Home Appliance feature, experience new features by upgrading the product through the **LG ThinQ** app.

#### • Scan to Cook

- Scan the barcode on a ready-made meal using the **LG ThinQ** application and send the recommended or customized cooking instructions straight to your oven. **Remote Start** must be activated on the oven to use Scan to Cook.

#### • Monitoring

- This function helps you check the current status, remaining time, cook settings and end time in one place.

#### • Product Notifications

- Turn on the Push Alerts to receive appliance status notifications. The notifications are triggered even if the **LG ThinQ** application is not open.

#### • Timer

- You can set the timer from the application.

#### • Settings

- Allows you to set various options on the oven and in the application.

#### • Smart Diagnosis™

- This function provides useful information for diagnosing and solving issues with the appliance based on the pattern of use.

#### • Firmware Update

- Keep the appliance updated.

### NOTE

- In the following cases, you must update the network information for each appliance in the **LG ThinQ** application under **Device Cards** → **Settings** → **Change Network**.

- wireless router is changed
- wireless router password is changed

- Internet service provider is changed
- This information is current at the time of publication. The application is subject to change for product improvement purposes without notice to users.
- In the lower oven, Scan to Cook cannot be used while the timer is running. Cancel the timer operation to use Scan to Cook.

## Installing LG ThinQ Application and Connecting an LG Appliance

### Models with QR Code

Scan the QR code attached to the product using the camera or a QR code reader application on your smartphone.



### Models without QR Code

- 1 Search for and install the **LG ThinQ** application from the Google Play Store or Apple App Store on a smartphone.
- 2 Run the **LG ThinQ** application and sign in with your existing account or create an LG account to sign in.
- 3 Touch the add (+) button on the **LG ThinQ** application to connect your LG appliance. Follow the instructions in the application to complete the process.

### NOTE

- To verify the Wi-Fi connection, check that the  icon on the control panel is lit.
- The appliance supports 2.4 GHz Wi-Fi networks only. To check your network frequency, contact your Internet service provider or refer to your wireless router manual.

- **LG ThinQ** is not responsible for any network connection problems or any faults, malfunctions, or errors caused by network connection.
- The surrounding wireless environment can make the wireless network service run slowly.
- If the distance between the appliance and the wireless router is too far, the signal becomes weak. It may take a long time to connect or fail to install the application.
- If the appliance is having trouble connecting to the Wi-Fi network, it may be too far from the router. Purchase a Wi-Fi repeater (range extender) to improve the Wi-Fi signal strength.
- The network connection may not work properly depending on the Internet service provider.
- The Wi-Fi may not connect or the connection may be interrupted because of the home network environment.
- If the appliance cannot be connected due to problems with the wireless signal transmission, unplug the appliance and wait about a minute before trying again.
- If the firewall on your wireless router is enabled, disable the firewall or add an exception to it.
- The wireless network name (SSID) should be a combination of English letters and numbers. (Do not use special characters.)
- Smartphone user interface (UI) may vary depending on the mobile operating system (OS) and the manufacturer.
- If the security protocol of the router is set to **WEP**, network setup may fail. Change the security protocol (**WPA2** is recommended), and connect the product again.
- To disable the **Wi-Fi** function, press and hold the **Wi-Fi** button for 3 seconds. The **Wi-Fi** indicator will be turned off.
- To reconnect the appliance or add another user, press and hold the **Wi-Fi** button for 3 seconds. Run the **LG ThinQ** application and follow the instructions in the application to connect the appliance.

## Installing the LG ThinQ Application

Search for the **LG ThinQ** application from the Google Play Store or Apple App Store on a smartphone. Follow instructions to download and install the application.

## LG UP Feature

Experience new features by updating the product through the **LG ThinQ** app.

If an updated feature is available, an update notification appears on the display and a melody sounds after cooking has finished and the **CLEAR/OFF** key is pressed.

For example, the lights on the display may light in sequence until **UP** appears.

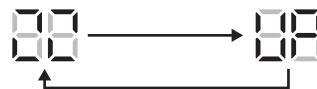

- 1 Update notifications are sent to your smartphone when updated features are available.
- 2 Press the update notification on your smartphone to go to the **Feature Updates** page in the **LG ThinQ** app.
- 3 On the **Feature Updates** page, select a new function and press the **Update** button.
  - Do not unplug the product during the update, as doing so may interrupt the update process.
- 4 After the update is complete, check the guide in the **LG ThinQ** app for detailed feature settings.

### NOTE

- This feature is only available on some models.
- After the update is complete, the actual product features may differ from those described in the owner's manual.

## Connecting to Wi-Fi

The **Wi-Fi** button, when used with the **LG ThinQ** application, allows the appliance to connect to a home Wi-Fi network. The  icon shows the status of the appliance's network connection. The icon illuminates when the appliance is connected to the Wi-Fi network.

### Initial Appliance Connection

Run the **LG ThinQ** application and follow the instructions in the application to connect the appliance.

### • Reconnecting the Appliance or Connecting Another User

Press and hold the **Wi-Fi** button for 3 seconds. Run the **LG ThinQ** application and follow the instructions in the application to connect the appliance.

## Radio Equipment Specifications

Type	Operating Frequency Range	Output Power (Max.)
Wireless LAN	2 400 MHz - 2 472 MHz	< 1 W
Bluetooth <sup>†</sup>	2 400 MHz - 2 483.5 MHz	

<sup>†</sup> This feature is only available on some models.

## FCC Statement

The following notice covers the transmitter module contained in this product.

This equipment has been tested and found to comply with the limits for a Class B digital device, pursuant to Part 15 of the FCC Rules. These limits are designed to provide reasonable protection against harmful interference in a residential installation. This equipment generates, uses, and can radiate radio frequency energy and, if not installed and used in accordance with the instructions, may cause harmful interference to radio communications. However, there is no guarantee that interference will not occur in a particular installation. If this equipment does cause harmful interference to radio or television reception, which can be determined by turning the equipment off and on, the user is encouraged to try to correct the interference by one or more of the following measures:

- Reorient or relocate the receiving antenna.
- Increase the separation between the equipment and the receiver.
- Connect the equipment into an outlet on a circuit different from that to which the receiver is connected.
- Consult the dealer or an experienced radio/TV technician for help.

This device complies with part 15 of the FCC Rules. Operation is subject to the following two conditions:

(1) This device may not cause harmful interference and

(2) This device must accept any interference received, including interference that may cause undesired operation.

Any changes or modifications in construction of this device which are not expressly approved by the party responsible for compliance could void the user's authority to operate the equipment.

## FCC RF Radiation Exposure Statement

This equipment complies with FCC radiation exposure limits set forth for an uncontrolled environment. This transmitter must not be co-located or operating in conjunction with any other antenna or transmitter.

This equipment should be installed and operated with a minimum distance of 20 cm (7.8 inches) between the antenna and your body. Users must follow the specific operating instructions for satisfying RF exposure compliance.

## Open Source Software Notice Information

To obtain the source code that is contained in this product, under GPL, LGPL, MPL, and other open source licenses that have the obligation to disclose source code, and to access all referred license terms, copyright notices and other relevant documents, please visit <https://opensource.lge.com>.

LG Electronics will also provide open source code to you on CD-ROM for a charge covering the cost of performing such distribution (such as the cost of media, shipping, and handling) upon email request to [opensource@lge.com](mailto:opensource@lge.com).

This offer is valid to anyone in receipt of this information for a period of three years after our last shipment of this product.

## Smart Diagnosis™ Feature

Use this feature to help you diagnose and solve problems with your appliance.

### NOTE

- For reasons not attributable to LGE's negligence, the service may not operate due to external factors such as, but not limited to, Wi-Fi unavailability, Wi-Fi disconnection, local app store policy, or app unavailability.

- The feature may be subject to change without prior notice and may have a different form depending on where you are located.

## Using LG ThinQ to Diagnose Issues

If you experience a problem with your Wi-Fi equipped appliance, it can transmit troubleshooting data to a smartphone using the **LG ThinQ** application.

- Launch the **LG ThinQ** application and select the **Smart Diagnosis** feature in the menu. Follow the instructions provided in the **LG ThinQ** application.

## Using Audible Diagnosis to Diagnose Issues

The image in this part may be different from the actual model.

Follow the instructions below to use the audible diagnosis method.

- Launch the **LG ThinQ** application and select the **Smart Diagnosis** feature in the menu. Follow the instructions for audible diagnosis provided in the **LG ThinQ** application.

- 1 Press the **START** button for 3 seconds.
  - If the display has been locked, you must deactivate the lock and then reactivate it.
- 2 Hold the mouthpiece of your phone in front of the control panel.

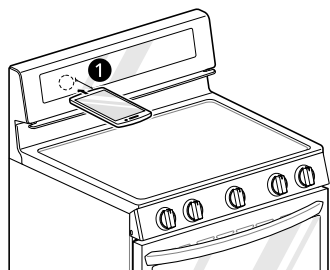

① Max: 3/8" (10 mm)

- 3 Keep the phone in place until the tone transmission has finished. The display will count down the time. Once the countdown is over and the tones have stopped, the diagnosis will be displayed in the application.

### NOTE

- For best results, do not move the phone while the tones are being transmitted.

# MAINTENANCE

## Cleaning

### ⚠ CAUTION

- Do not clean this appliance with bleach.
- To prevent burns, wait until the cooktop has cooled down before touching any of its parts.
- Always wear gloves when cleaning the cooktop.

## Interior

Do not use oven cleaners to clean the oven cavity. Use the product's **EasyClean** function regularly to clean light soil. For stubborn soil, use the **Self Clean** function (on some models) or clean manually using the following tips.

- A plastic spatula can be used as a scraper to scrape off any chunks or debris before and during oven cleaning.
- Using the rough side of a non-scratch scouring pad may help to take off burnt-on stains better than a soft sponge or towel.
- Certain non-scratch scrubbing sponges, such as those made of melamine foam, available at local stores, can also help improve cleaning.

### ⚠ CAUTION

- Do not use oven cleaners, harsh chemical cleaners, bleach, vinegar, steel scouring pads, or abrasive pads or cleansers to clean the oven, as they can permanently damage the oven surface.
- Do not clean the gasket.

## Exterior

### Control Panel

To prevent activating the control panel during cleaning, disconnect power to the appliance. Clean up splatters with a damp cloth using a glass cleaner. Remove heavier soil with warm, soapy water. Do not use abrasives of any kind.

### Front Manifold Panel and Knobs

It is best to clean the manifold panel after each use of the range. For cleaning, use a damp cloth and mild soapy water or a 50/50 solution of vinegar and water. Rinse with clean water and polish dry with a soft cloth.

### ⚠ CAUTION

- Do not use abrasive cleansers, strong liquid cleaners, plastic scouring pads or oven cleaners on the manifold panel. Doing so will damage the finish.
- Do not try to bend the knobs by pulling them up or down, and do not hang a towel or other objects on them. This can damage the gas valve shaft.
- The control knobs may be removed for easy cleaning.
- To clean the knobs, make sure that they are in the **OFF** position and pull them straight off the stems.
- To replace the knobs, make sure the knob has the **OFF** position centered at the top, and slide the knob directly onto the stem.

### NOTE

- To prevent scratching, do not use abrasive cleaners on any of these materials.

## Painted and Decorative Trim

For general cleaning, use a cloth with hot soapy water. For more difficult soils and built-up grease, apply a liquid detergent directly onto the soil. Leave it on for 30 to 60 minutes. Rinse with a damp cloth and dry. Do not use abrasive cleaners.

## Stainless Steel Surfaces

To avoid scratches, do not use steel wool pads.

- 1 Place a small amount of stainless steel appliance cleaner or polish on a damp cloth or paper towel.
- 2 Clean a small area, rubbing with the grain of the stainless steel if applicable.
- 3 Dry and buff with a clean, dry paper towel or soft cloth.
- 4 Repeat as necessary.

**NOTE**

- To clean the stainless steel surface, use warm sudsy water or a stainless steel cleaner or polish.
- Always wipe in the direction of the metal surface finish.
- Stainless steel appliance cleaner or polish can be purchased online or from most retailers of appliances or home goods.

**Oven Door**

**⚠ CAUTION**

- Do not use harsh cleaners or harsh abrasive cleaning materials on the outside of the oven door. Doing so can cause damage.
- Use soapy water to thoroughly clean the oven door. Rinse well. Do not immerse the door in water.
- You may use a glass cleaner on the outside glass of the oven door. Do not spray water or glass cleaner on the door vents.
- Do not use oven cleaners, cleaning powders, or harsh abrasive cleaning materials on the outside of the oven door.
- Do not clean the oven door gasket. The oven door gasket is made of a woven material that is essential for a good seal. Care should be taken not to rub, damage, or remove this gasket.

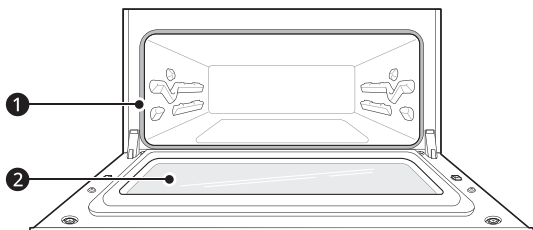

- ❶ Don't hand clean oven door gasket
- ❷ Do hand clean door

**Broiler Pan and Grid**

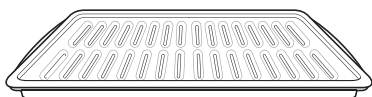

- Do not store a soiled broiler pan or grid anywhere in the range.
- Do not clean the broiler pan or grid in a self cleaning mode. (Available on some models)

- Remove the grid from the pan. Carefully pour out the grease from the pan into a proper container.
- Wash and rinse the broiler pan and grid in hot water with a soap-filled or plastic scouring pad.
- If food has burned on, sprinkle the grid with cleaner while hot and cover with wet paper towels or a dishcloth. Soaking the pan will remove burned-on foods.
- Both the broiler pan and grid may be cleaned with a commercial oven cleaner or in the dishwasher.

**Oven Racks**

Remove the oven racks before operating the Self Clean cycle (on some models) and EasyClean.

- 1 Clean with a mild, abrasive cleaner.
  - Food spilled into the tracks could cause the racks to become stuck.
- 2 Rinse with clean water and dry.

**NOTE**

- For models with Self Clean function:
  - If the racks are cleaned using the Self Clean cycle (not recommended), the color will turn slightly blue and the finish will become dull. After the Self Clean cycle is complete, and the oven has cooled, rub the sides of the racks with wax paper or a cloth containing a small amount of oil. This will make the racks glide more easily into the rack tracks.

**Vent Louvers**

- The appearance of the range may differ from model to model.

Use a vacuum cleaner with a brush or crevice attachment to clean the vent louvers ❶. Do not remove the panel covering the range.

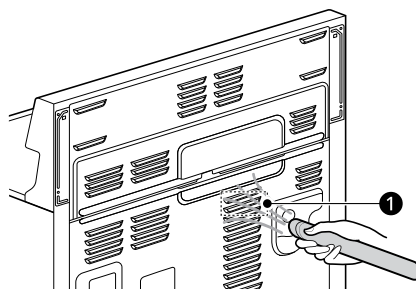

## Cooktop Surface

### Glass-Ceramic Cooktop

---

**⚠ WARNING**

- To protect hands from burns, always wear oven mitts or use pot holders while using a scraper on the hot cooking surface.
- 

---

**⚠ CAUTION**

- If any sugar or food containing sugar spills, or plastic or foil melts on the cooktop, remove the material IMMEDIATELY with a metal razor scraper while the cooking surface is still hot to avoid the risk of damage to the glass-ceramic surface. When used correctly, the scraper will not damage the cooktop surface.
  - If water or food containing water spills, remove the spill IMMEDIATELY with a dry paper towel.
  - Do not use scrub pads or abrasive cleaning pads. They may damage your cooktop surface.
- 

Use ceramic cooktop cleaner on the glass cooktop. Other cleaners may not be as effective or may scratch, damage or stain the cooktop surface.

To maintain and protect the surface of the glass cooktop, follow these steps:

- 1** Before using the cooktop for the first time, clean it with a ceramic cooktop cleaner. This helps protect the top and makes cleanup easier.
- 2** Use ceramic cooktop cleaner daily to help keep the cooktop looking new.
- 3** Shake the cleaner well. Apply a few drops of cleaner directly to the cooktop.
- 4** Use a paper towel to clean the entire cooktop surface.
- 5** Rinse with clear water and use a dry cloth or paper towel to remove all cleaning residue.

---

**NOTE**

- Any damage or failure of the product resulting from the items below may not be covered under the LIMITED WARRANTY.
    - Sugary spillovers (such as preserves, ketchup, tomato sauce, jellies, fudge, candy, syrups, or chocolate) or melted plastics can cause pitting on the surface of your cooktop.
    - If food or water containing calcium (such as baking powder, wine, milk, spinach, or broccoli) is spilled on the cooktop, it can permanently stain or discolor the surface.
- 

### Burned-On Residue

- 1** While the cooktop is still warm, remove any burnt on deposits or spilled food from the glass-ceramic cooking surface with a suitable metal razor scraper.

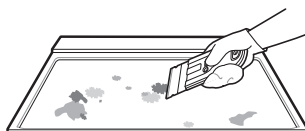

**NOTE**

- Do not use a dull or nicked blade.
- Hold the scraper at approximately a 30° angle to the cooktop.
- The razor scraper will not damage the markings on the cooking surface.
- Take care to avoid damaging the seal when cleaning the cooktop with a metal razor scraper.

- 2** When the cooking surface has completely cooled, apply a few fingertip-sized dabs of a glass-ceramic cooktop cleaner in each burner area. Spread the cleaner over the cooktop surface with a damp paper towel. Leave the cleaner on for 10 minutes before rinsing it off.

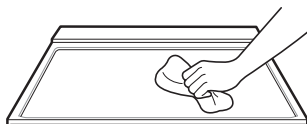

- 3** Rinse with clean water and wipe the cooktop surface with a clean, dry paper towel.

**Cooktop Seal**







- 1** To remove burned-on soil from the seal around the outside of the glass-ceramic cooktop, cover the area with a warm, wet cloth to soften the soil.
- 2** After a few minutes, wipe the area clean with a mild, nonabrasive cleaner.

**⚠ CAUTION**

- Do not use a knife or any sharp object to clean the seal around the outside of the glass-ceramic cooktop.
- Take care to avoid damaging the seal when cleaning the cooktop with a metal razor scraper.

**Maintaining the Cooktop****⚠ CAUTION**

- Do not use chlorine bleach, ammonia, or other cleaners not specifically recommended for use on glass-ceramic cooktops.
- Let your glass-ceramic cooking surface cool off before cleaning.

-	Wipe off with a damp towel and mild detergent	Use a metal scraper	Apply cooktop cleaner. Rub with a towel.	Rinse with a damp towel, then wipe dry.
Regular (Recommended after each use)		-	-	-
Occasional (Recommended every week)	-	-		
Thorough (Recommended for tough stains or burnt-on food)	-			

**NOTE**

- For additional product information, visit our website at [www.lg.com](http://www.lg.com)

**Metal Marks and Scratches****⚠ CAUTION**

- Always use heavier gauge, high-quality cookware on the cooking elements and do not slide it on the ceramic cooktop surface. Even high-quality cookware can scratch the cooktop surface.

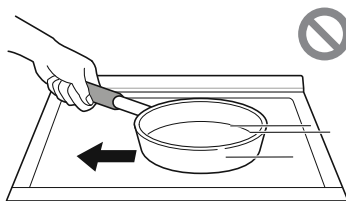

- Any cookware that has a rough or dirty bottom can mark and scratch the cooktop surface. Always start with clean cookware.
- Do not use cookware if there is foreign matter on the cooktop surface. Always clean the cooktop surface before cooking.

**NOTE**

- Any damage or failure of the product resulting from the items below may not be covered under the LIMITED WARRANTY.
  - Be careful not to slide pots and pans across the cooktop. Doing so will leave metal markings on the cooktop surface. To help remove these marks, use a ceramic cooktop cleaner with a cleaning pad for ceramic cooktops.
  - If pots with a thin overlay of aluminum or copper are allowed to boil dry, the overlay may leave a black discoloration on the cooktop. This should be removed immediately before heating again or the discoloration may be permanent.

**EasyClean**

LG's EasyClean enamel technology provides two

cleaning options for the inside of the range. The EasyClean feature takes advantage of LG's new enamel to help lift soils without harsh chemicals,

and it runs using ONLY WATER for just 10 minutes in low temperatures to help loosen LIGHT soils before hand cleaning.

While EasyClean is quick and effective for small and LIGHT soils, the Self Clean feature can be used to remove HEAVY, built up soils. The intensity and high heat of the Self Clean cycle may result in smoke which will require the opening up of windows to provide ventilation. Compared to the more intense Self Clean process, your LG oven gives you the option of cleaning with LESS HEAT, LESS TIME, and virtually NO SMOKE OR FUMES. You can reduce energy use by cleaning light oven soils with the EasyClean feature instead of Self Clean.

When needed, the range still provides the Self Clean option for longer, more thorough oven cleaning for heavier, built up soils.

- For hard to reach areas such as the back surface of the oven, it is better to use the Self Clean cycle.

### Benefits of EasyClean

- Helps loosen light soils before hand-cleaning
- EasyClean only uses water; no chemical cleaners
- Makes for a better Self Clean experience
  - Delays the need for a Self Clean cycle
  - Minimizes smoke and odors
  - Can allow shorter Self Clean time

### NOTE

- For models without Self Clean option
  - The EasyClean feature may not be effective in removing heavy, built-up soils. Because the range does not include a Self Clean option, clean the oven regularly using the EasyClean feature to prevent heavy, burnt-on soil from building up in the oven.

### When to Use EasyClean

- Example of oven soiling

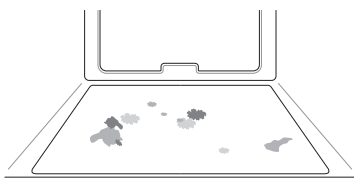

#### Case 1

- Soil pattern: Small drops or spots

- Types of soils: Cheese or other ingredients
- Common food items that can soil your oven: Pizza

#### Case 2

- Soil pattern: Light splatter
- Types of soils: Fat/grease
- Common food items that can soil your oven: Steaks, broiled / Fish, broiled / Meat roasted at low temperatures

### EasyClean Instruction Guide

#### NOTE

- Allow the oven to cool to room temperature before using the EasyClean cycle. If your oven cavity is above 150 °F (65 °C), Hot will appear in the display, and the EasyClean cycle will not be activated until the oven cavity cools down.
- The range should be level to ensure that the bottom surface of the oven cavity is entirely covered by water at the beginning of the EasyClean cycle.
- For best results, use distilled or filtered water. Tap water may leave mineral deposits on the oven bottom.
- Soil baked on through several cooking cycles will be more difficult to remove with the EasyClean cycle.
- Do not open the oven door during the EasyClean cycle. Water will not get hot enough if the door is opened during the cycle.

- 1 Remove oven racks and accessories from the oven.
- 2 Scrape off and remove any burnt-on debris with a plastic scraper.

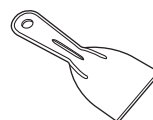

- Suggested plastic scrapers:
  - Hard plastic spatula
  - Plastic pan scraper
  - Plastic paint scraper
  - Old credit card

- 3 Fill a spray bottle (10 oz or 300 ml) with water and use the spray bottle to thoroughly spray the inside surfaces of the oven.
- 4 Use at least 1/5 (2 oz or 60 ml) of the water in the bottle to completely saturate the soil on both the walls and in the corners of the oven.

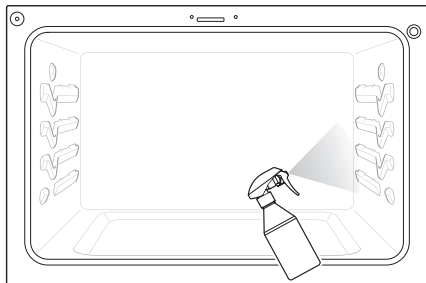

- 5 Spray or pour the remaining water (8 oz or 240 ml) onto the bottom center of the oven cavity. The indentation on the oven bottom should be fully covered to submerge all soils. Add water if necessary.

---

**NOTE**

- If cleaning multiple ovens, use an entire bottle of water to clean each oven. Do not spray water directly on the door. Doing so will result in water dripping to the floor.
- 

- 6 Close the oven door. Press **EasyClean**. Press **START**.

---

**⚠ CAUTION**

- Some surfaces may be hot after the EasyClean cycle. Wear rubber gloves while cleaning to prevent burns.
  - During the EasyClean cycle, the oven becomes hot enough to cause burns. Wait until the cycle is over before wiping the inside surface of the oven. Failure to do so may result in burns.
  - Avoid leaning or resting on the oven door glass while cleaning the oven cavity.
- 

- 7 A tone will sound at the end of the cycle. Press **CLEAR/OFF** to clear the display and end the tone.

- 8 After the cleaning cycle and during hand-cleaning, enough water should remain on the oven bottom to completely submerge all soils. Add water if necessary. Place a towel on the floor in front of the oven to capture any water that may spill out during hand-cleaning.

- 9 Clean the oven cavity immediately after the EasyClean cycle by scrubbing with a wet, non-scratch scouring sponge or pad. (The scouring side will not scratch the finish.) Some water may spill into the bottom vents while cleaning, but it will be captured in a pan under the oven cavity and will not hurt the burner.

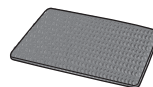

---

**NOTE**

- Do not use any steel scouring pads, abrasive pads or cleaners as these materials can permanently damage the oven surface.
- 

- 10 Once the oven cavity is cleaned, wipe any excess water with a clean dry towel. Replace racks and any other accessories.

- 11 If some light soils remain, repeat the above steps, making sure to thoroughly soak the soiled areas.
  - For models with Self Clean function
    - If stubborn soils remain after multiple EasyClean cycles, run the Self Clean cycle. Be sure that the oven cavity is empty of oven racks and other accessories, and that the oven cavity surface is dry before running the Self Clean cycle. Consult the Self Clean section of your owner's manual for further details. If a Self Clean option is not available, scrape off and remove stubborn soil using a scraper.

---

**NOTE**

- If you forget to saturate the inside of the oven with water before starting EasyClean, press **CLEAR/OFF** to end the cycle. Wait for the range to cool to room temperature and then spray or pour water into the oven and start another EasyClean cycle.

- The cavity gasket may be wet when the EasyClean cycle finishes. This is normal. Do not clean the gasket.
- If mineral deposits remain on the oven bottom after cleaning, use a cloth or sponge soaked in vinegar to remove them.
- It is normal for the fan to operate during the EasyClean cycle.
- Using commercial oven cleaners or bleach to clean the oven is not recommended. Instead, use a mild liquid cleanser with a pH value below 12.7 to avoid discoloring the enamel.

## Self Clean

This feature is only available on some models.

The Self Clean cycle uses extremely hot temperatures to clean the oven cavity. While running the Self Clean cycle, you may notice smoking or an odor. This is normal, especially if the oven is heavily soiled. During Self Clean, the kitchen should be well ventilated to minimize the odors from cleaning.

### Before Starting Self Clean

- Clean only parts listed in manual. Remove the oven racks, broiler pan, broiler grid, all cookware, aluminum foil or any other material from the oven.
  - If oven racks are left in the oven cavity during the Self Clean cycle, they will discolor and become difficult to slide in and out.
- The kitchen should be well ventilated to minimize the odors from cleaning. Open a window or turn on a ventilation fan or hood before self-cleaning.
- Wipe any heavy spillovers on the bottom of the oven.
- Make sure that the oven light cover is in place and the oven light is off.
- Clean the frame of the oven and door with hot soapy water. Rinse well.

### WARNING

- If the oven is heavily soiled with oil, self-clean the oven before using the oven again. The oil could cause a fire.
- If there is a fire in the oven during self-clean, turn the oven off and wait for the fire to go out. Do not force the door open. Introduction of fresh air at self-clean temperatures may lead to

a burst of flame from the oven. Failure to follow this instruction may result in severe burns.

### CAUTION

- Do not use oven cleaners. Commercial oven cleaner or oven liner protective coating of any kind should not be used in or around any part of the oven.
- The oven displays an F error code and sounds three long beeps during the self-cleaning process if it malfunctions in the self-clean mode. Switch off the electrical power to the main fuse or breaker and have the oven serviced by a qualified technician.
- If the self cleaning mode malfunctions, turn the range off and disconnect the power supply. Have it serviced by a qualified technician.
- It is normal for parts of the oven to become hot during a Self Clean cycle. Avoid touching the cooktop, door, window or oven vent area during a Self Clean cycle.
- Do not leave small children unattended near the appliance. During the Self Clean cycle, the outside of the range can become very hot to the touch.
- If you have pet birds, move them to another well-ventilated room. The health of some birds is extremely sensitive to the fumes given off during the Self Clean cycle of any range.
- Do not line the oven walls, racks, bottom or any other part of the range with aluminum foil or any other material. Doing so will destroy heat distribution, produce poor baking results and cause permanent damage to the oven interior (aluminum foil will melt to the interior surface of the oven).
- Do not force the door open. This can damage the automatic door locking system. Use care when opening the oven door after the Self Clean cycle. Stand to the side of the oven when opening the door to allow hot air or steam to escape. The oven may still be VERY HOT.

### NOTE

- The oven light cannot be turned on during a Self Clean cycle. The oven light cannot be turned on until the oven temperature has cooled below 500 °F (260 °C) after a Self Clean cycle is complete.
- During the Self Clean cycle, the cooktop elements cannot be used.
- Clean the frame of the oven and door with hot soapy water. Rinse well.

**NOTE**

- Do not clean the gasket. The fiberglass material of the oven door gasket cannot withstand abrasion. It is essential for the gasket to remain intact. If you notice it becoming worn or frayed, replace it.
- It is normal for the fan to operate during the Self Clean cycle.
- As the oven heats, you may hear sounds of metal parts expanding and contracting. This is normal and will not damage the oven.
- You may notice some white ash in the oven. Wipe it off with a damp cloth or a soap-filled steel wool pad after the oven cools. If the oven is not clean after one Self Clean cycle, repeat the cycle.
- If oven racks were left in the oven and do not slide smoothly after a Self Clean cycle, wipe racks and rack supports with a small amount of vegetable oil to make them glide more easily.
- After a Self Clean cycle, fine lines may appear in the porcelain because it went through heating and cooling. This is normal and will not affect performance.
- The Self Clean cycle cannot be started if the Control Lock / Lockout feature is active.
- Once the Self Clean cycle is set, the oven door locks automatically. You will not be able to open the oven door until the oven is cooled. The lock releases automatically.
- Once the door has been locked, the lock  indicator light stops flashing and remains on. Allow about 15 seconds for the oven door lock to activate.
- If the clock is set for a 12-hour display (default) the Delayed Self Clean can never be set to start more than 12 hours in advance.
- After the oven is turned off, the convection fan keeps operating until the oven has cooled down.

**When to Use Self Clean**

- Example of oven soiling

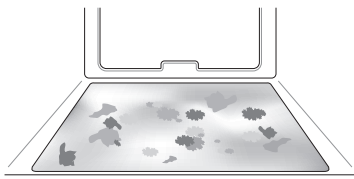
**Case 1**

- Soil pattern: Medium to heavy splatter
- Types of soils: Fat/grease
- Common food items that can soil your oven: Meat roasted at high temperatures

**Case 2**

- Soil pattern: Drops or spots
- Types of soils: Filling or sugar based soils
- Common food items that can soil your oven: Pies

**Case 3**

- Soil pattern: Drops or spots
- Types of soils: Cream or tomato sauce
- Common food items that can soil your oven: Casseroles

**NOTE**

- The Self Clean cycle can be used for soil that has been built up over time.

**Setting Self Clean**

The Self Clean function has cycle times of 3, 4, or 5 hours.

**Self Clean Soil Guide**

Soil Level	Cycle Setting
Lightly Soiled Oven Cavity	3-Hour Self Clean
Moderately Soiled Oven Cavity	4-Hour Self Clean
Heavily Soiled Oven Cavity	5-Hour Self Clean

- 1 Remove all racks and accessories from the oven.
- 2 Press **Self Clean**.  
The oven defaults to the recommended four-hour Self Clean for a moderately soiled oven. Press buttons as below to select a self clean time from 3 to 5 hours.
  - 1 : 3 hours
  - 2 : 4 hours
  - 3 : 5 hours

- 3 Press **START**.
- 4 Once the Self Clean cycle is set, the oven door locks automatically and the lock icon  displays. You will not be able to open the oven door until the oven has cooled. The lock releases automatically when the oven has cooled.

### CAUTION

- Do not force the oven door open when the lock icon is displayed. The oven door remains locked until the oven temperature has cooled. Forcing the door open will damage the door.

## Setting Self Clean with a Delayed Start

- 1 Remove all racks and accessories from the oven.
- 2 Press **Self Clean**.  
The oven defaults to the recommended four-hour self clean for a moderately soiled oven. Press buttons as below to select a self clean time from 3 to 5 hours.
  - 1 : 3 hours
  - 2 : 4 hours
  - 3 : 5 hours
- 3 Press **Start Time**.
- 4 Set the time of day you would like the Self Clean to start by pressing numbers.
- 5 Press **START**.

### NOTE

- It may become necessary to cancel or interrupt a Self Clean cycle due to excessive smoke or fire in the oven. To cancel the Self Clean function, press **CLEAR/OFF**.

## Removing/Assembling Lift-Off Oven Doors

### NOTE

- Parts may be changed due to product improvement and may look different than shown in images.

## Door Care Instructions

Most oven doors contain glass that can break.

### CAUTION

- Do not close the oven door until all the oven racks are fully in place.
- Do not hit the glass with pots, pans, or any other object.
- Scratching, hitting, jarring, or stressing the glass may weaken its structure causing an increased risk of breakage at a later time.
- Be careful when removing and lifting the door.
- Do not lift the door by the handle. The door is very heavy.

## Upper Oven

### Removing the Door

- 1 Fully open the door.
- 2 Lift up and rotate the hinge locks toward the hinge until they stop.

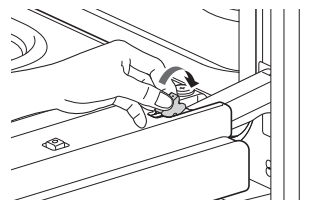

- 3 Close the door to 30 degrees  (you will feel the door stop). The hinge locks will contact the oven frame.

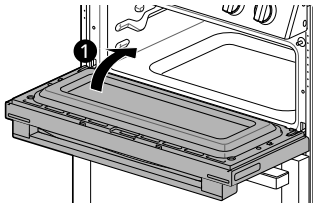

- 4** Press the hinge release buttons **2** on either side of the door.

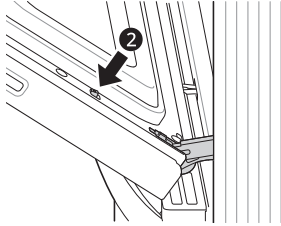

- 5** Lift the door up until it is clear of the hinges.

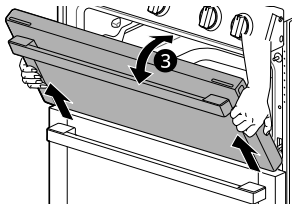

**3** about 30°

### Assembling the Door

- 1** Be sure both hinges are in a 30 degree position.
- 2** Slide the door back onto the hinges until you hear a solid click and the release buttons have engaged.

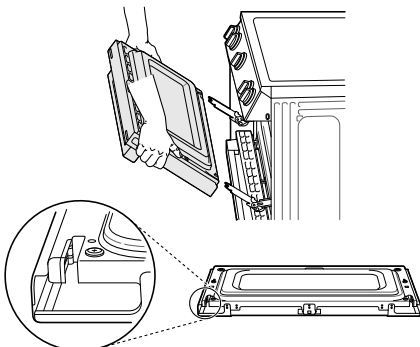

- 3** Fully open the door.

- 4** Push the hinge locks down onto the door frame.

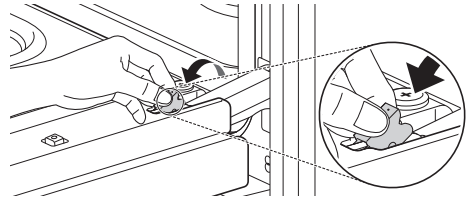

- 5** Close the oven door.

### Lower Oven

#### Removing the Door

- 1** Fully open the door.
- 2** Unlock the hinge locks, rotating them as far toward the open door frame as they will go.

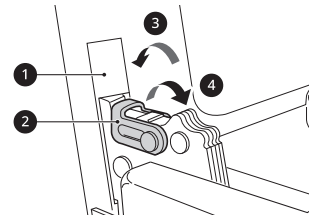

- 1** Slot
- 2** Hinge Lock
- 3** Lock
- 4** Unlock

- 3** Firmly grasp both sides of the door at the top.

- 4** Close the door to the removal position (approximately five degrees) which is halfway between the broil stop position and fully closed. If the position is correct, the hinge arms will move freely.

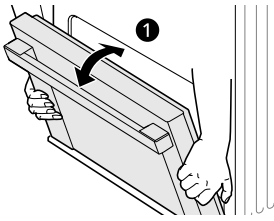

1 about 5°

- 5 Lift door up and out until the hinge arms are clear of the slots.

### Assembling the Door

- 1 Firmly grasp both sides of the door at the top.
- 2 With the door at the same angle as the removal position, seat the indentation of the hinge arms into the bottom edge of the hinge slots. The notch in the hinge arms must be fully seated into the bottom edge of the slots.

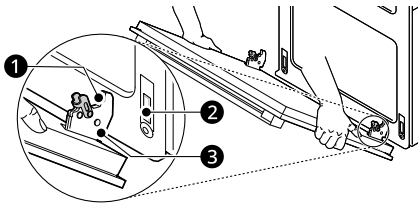

- 1 Hinge arm
- 2 Bottom edge of slot
- 3 Indentation

- 3 Open the door fully. If the door will not open fully, the indentation is not seated correctly in the bottom edge of the slots.
- 4 Lock the hinge locks, rotating them back toward the slots in the oven frame until they lock.

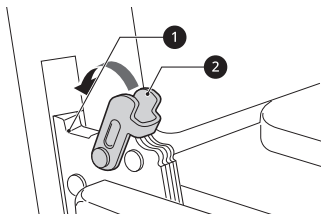

- 1 Hinge arm
- 2 Hinge lock

- 5 Close the oven door.

## Periodic Maintenance

### Changing the Oven Light

The oven light is a standard 40-watt appliance halogen lamp. It turns on when the oven door is open. When the oven door is closed, press **Light** to turn it on or off.

#### **⚠ WARNING**

- Make sure that the oven and lamp are cool.
- Disconnect the electrical power to the range at the main fuse or circuit breaker panel. Failure to do so can result in severe personal injury, death, or electrical shock.

- 1 Unplug the range or disconnect power.
- 2 Turn the glass lamp cover in the back of the oven counterclockwise to remove.
- 3 Remove the halogen lamp from the socket.
- 4 Insert the new halogen lamp.
- 5 Insert the glass lamp cover and turn it clockwise.
- 6 Plug in the range or reconnect the power.

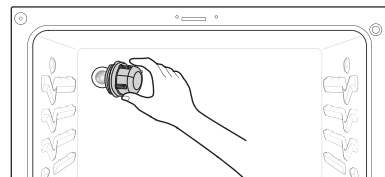

# TROUBLESHOOTING

## FAQs

### Frequently Asked Questions

**Q: What types of cookware are recommended for use with the cooktop?**

- A:
- The pans must have a flat bottom and straight sides.
  - Only use heavy-gauge pans.
  - The pan size must match the amount of food to be prepared and the size of the surface element.
  - Use tight fitting lids.
  - Only use flat-bottom woks.

**Q: My new oven doesn't cook like my old one. Is there something wrong with the temperature settings?**

- A: No. Your oven has been factory tested and calibrated. For the first few uses, follow your recipe times and temperatures carefully. If you still think your new oven is too hot or too cold, you can adjust the oven temperature yourself to meet your specific cooking needs. Refer to the Changing Oven Settings section in this manual for easy instructions on how to adjust your thermostat.

**Q: Is it normal to hear a clicking noise coming from the back of my oven when I am using it?**

- A: Your new range is designed to maintain a tighter control over your oven's temperature. You may hear your oven's heating elements click on and off more frequently on your new oven. This is NORMAL.

**Q: Why is the time flashing?**

- A: This means that the product has just been plugged in, or that it has experienced a power interruption. To clear the flashing time, touch any button and reset the clock if needed.

**Q: During convection cooking the fan stops when I open the door. Is that normal?**

- A: Yes, this is normal. When the door is opened, the convection fan will stop until the door is closed.

**Q: Can I use aluminum foil to catch drippings in my oven cavity?**

- A: Never use aluminum foil to line the bottom or sides of the oven or the warming drawer (on some models). The foil will melt and stick to the bottom surface of the oven and will not be removable. Use a foil-lined sheet pan placed on a lower oven rack to catch drippings instead. (If foil has already melted onto the bottom of the oven, it will not interfere with the oven's performance.)

**Q: Can I use aluminum foil on the racks?**

- A: Do not cover racks with aluminum foil. Covering entire racks with foil restricts air flow, leading to poor cooking results. Use a sheet pan lined with foil under fruit pies or other acidic or sugary foods to prevent spillovers from damaging the oven finish.

---

### CAUTION

- Foil may be used to wrap food in the oven or warming drawer, but do not allow the foil to come into contact with the exposed heating/broiling elements in the oven. The foil could melt or ignite, causing smoke, fire, or injury.

---

**Q: Can I leave my racks in the oven when running a Self Clean cycle? (On some models)**

- A: No. Although it will not damage the racks, it will discolor them and may make them hard to slide in and out during use. Remove all items from the oven before starting a Self Clean cycle.

**Q: What should I do if my racks are sticky and have become hard to slide in and out?**

A: Over time, the racks may become hard to slide in and out. Apply a small amount of olive oil to the sides of the racks. This will work as a lubricant for easier gliding.

**Q: What should I do for hard to remove stains on my cooktop?**

A: The cooktop should be cleaned after every use to prevent permanent staining. When cooking foods with high sugar content, such as tomato sauce, clean the stain off with a scraper while the cooktop is still warm. Use an oven mitt when scraping to prevent burns. Refer to the MAINTENANCE section of this owner's manual for further instruction.

**Q: Why aren't the function buttons working?**

A: Make sure that the range is not in Control Lock / Lockout mode. The lock  will show in the display if Control Lock / Lockout is activated. To deactivate Control Lock / Lockout, refer to the Control Lock / Lockout section. The unlock melody sounds and **Loc** appears in the display until the controls are unlocked.

**Q: My range is still dirty after running the EasyClean cycle. What else should I do?**

A: The EasyClean cycle only helps to loosen light soils in your oven range to assist in hand-cleaning of your oven. It does not automatically remove all soils after the cycle. Some scrubbing of your oven range is required after running the EasyClean cycle.

**Q: I tried scrubbing my oven after running EasyClean, but some soils still remain. What can I do?**

A: The EasyClean feature works best when the soils are fully soaked and submerged in water before running the cycle and during hand-cleaning. If soils are not sufficiently soaked in water, it can negatively affect the cleaning performance. Repeat the EasyClean process using sufficient water.

- For models with Self Clean function:

Sugar-based and certain greasy soils are especially hard to clean. If some stubborn soils remain, use the Self Clean feature to thoroughly clean your oven.

**Q: Soils on my oven walls are not coming off. How can I get the oven walls clean?**

A: Soils on the side and rear walls of your oven range may be more difficult to fully soak with water. Try repeating the EasyClean process with more than the  $\frac{1}{4}$  cup (2 oz or 60 ml) of spray recommended.

**Q: Will EasyClean get all of the soils and stains out completely?**

A: It depends on the soil type. Sugar-based and certain grease stains are especially hard to clean. Also, if stains are not sufficiently soaked in water, this can negatively affect cleaning performance.

- For models with Self Clean function:

If stubborn or built-up stains remain, use the Self Clean feature. Refer to the Self Clean section of your owner's manual.

**Q: Are there any tricks to getting some of the stubborn soils out?**

A: Scraping the soils with a plastic scraper before and during hand-cleaning is recommended. Fully saturating soils with water is also recommended.

- For models with Self Clean function:

Certain types of soils are harder to clean than others. For these stubborn soils, the Self Clean cycle is recommended. Consult the Self Clean section of your owner's manual for details.

**Q: Is it safe for my convection fan or heater element to get wet during EasyClean?**

A: Yes. The convection fan or heater element may get a little wet during cleaning. However, direct spray onto the broil burner and heater elements is not necessary because these are self-cleaning during regular use.

**Q: Do I need to use all 1  $\frac{1}{4}$  cups (10 oz or 300 ml) of water for EasyClean?**

A: Yes. It is highly recommended that 1 cup (8 oz or 240 ml) of water be sprayed or poured on the bottom and an additional ¼ cup (2 oz or 60 ml) of water be sprayed on walls and other soiled areas to fully saturate the soils for better cleaning performance.

**Q: I see smoke coming out of my oven range's cooktop vents during EasyClean. Is this normal?**

A: This is normal. This is not smoke. It is actually water vapor (steam) from the water in the oven cavity. As the oven heats briefly during EasyClean, the water in the cavity evaporates and escapes through the oven vents.

**Q: How often should I use EasyClean?**

A: EasyClean can be performed as often as you wish. EasyClean works best when your oven is LIGHTLY soiled from such things as LIGHT grease splatter and small drops of cheese. Please refer to the EasyClean section in your owner's manual for more information.

**Q: What is required for EasyClean?**

A: A spray bottle filled with 1¼ cups (10 oz or 300 ml) of water, a plastic scraper, a non-scratch scrubbing pad and a towel. You should not use abrasive scrubbers such as heavy-duty scouring pads or steel wool.

**Q: Can I run the EasyClean cycle on both of my ovens at once?**

A: Yes. You can run the EasyClean cycle on both ovens at the same time. Some oven surfaces will be hot after the cycle completes running. Avoid leaning or resting on the oven door glass while cleaning the oven cavities. You cannot run the Self Clean cycle on both ovens at the same time.

**Q: Is it safe for water to spill into the oven bottom vents during cleaning?**

A: Some water spillage into the oven bottom vents (gas range) is okay. However, it is recommended to try avoid spilling too much water into the vents.

**Q: How can I help keep children safe around the range?**

A: Children should be supervised around the range whenever it is in use, and after use until surfaces have cooled. You can also use the Control Lock / Lockout feature to help prevent children from accidentally turning on the cooktop or oven. The Control Lock / Lockout feature disables most control panel buttons and the cooktop control knobs. On some models, it also locks the oven door. Consult the Control Lock / Lockout section of your owner's manual for details. (In models without a Self Clean option, the Control Lock / Lockout feature locks the controls but does not lock the oven door.)

**Q: The third knob from the right doesn't light up. Is that normal? (On some models)**

A: This is normal. Your range is designed to light up only 5 burner knobs.

**Q: Why isn't the Instaview working? (On some models)**

A: Level the range by adjusting the leveling legs with a wrench.

## Before Calling for Service

Review this section before calling for service; doing so will save you both time and money.

For detailed information or videos, visit [www.lg.com](http://www.lg.com) for the troubleshooting page.

## Cooking

Problem	Possible Cause & Solution
Oven will not work	<p><b>Plug on range is not completely inserted in the electrical outlet.</b></p> <ul style="list-style-type: none"> <li>• Make sure electrical plug is plugged into a live, properly grounded outlet.</li> </ul>

Problem	Possible Cause & Solution
<b>Oven will not work</b>	<b>A fuse in your home may be blown or the circuit breaker tripped.</b> <ul style="list-style-type: none"> <li>• Replace the fuse or reset the circuit breaker.</li> </ul>
	<b>Oven controls improperly set.</b> <ul style="list-style-type: none"> <li>• See the "Oven" section in the Operation chapter.</li> </ul>
	<b>Oven too hot.</b> <ul style="list-style-type: none"> <li>• Allow the oven to cool to below locking temperature.</li> </ul>
<b>Steam is exhausted through the oven vent.</b>	<b>Cooking foods with high moisture produces steam.</b> <ul style="list-style-type: none"> <li>• This is normal.</li> </ul>
<b>Appliance does not operate.</b>	<b>Cord is not plugged in correctly.</b> <ul style="list-style-type: none"> <li>• Make sure cord is plugged correctly into outlet. Check circuit breakers.</li> </ul>
	<b>Service wiring is not complete.</b> <ul style="list-style-type: none"> <li>• Contact your electrician for assistance.</li> </ul>
	<b>Power outage.</b> <ul style="list-style-type: none"> <li>• Check house lights to be sure. Call your local electric company for service.</li> </ul>
	<b>Sabbath mode is activated (on some models). 5b appears in the display and all function buttons are inactive.</b> <ul style="list-style-type: none"> <li>• Press and hold the Settings button for 3 seconds or until 5b disappears from the display.</li> </ul>
<b>Oven smokes excessively during broiling.</b>	<b>Control not set properly.</b> <ul style="list-style-type: none"> <li>• Follow instructions under Setting Oven Controls.</li> </ul>
	<b>Meat too close to the element.</b> <ul style="list-style-type: none"> <li>• Reposition the rack to provide proper clearance between the meat and the element. Preheat broil element for searing.</li> </ul>
	<b>Meat not properly prepared.</b> <ul style="list-style-type: none"> <li>• Remove excess fat from meat. Cut remaining fatty edges to prevent curling.</li> </ul>
	<b>Insert on broiler pan wrong side up and grease not draining.</b> <ul style="list-style-type: none"> <li>• Always place the grid on the broiler pan with ribs up and slots down to allow grease to drip into the pan.</li> </ul>
	<b>Grease has built up on oven surfaces. Old grease or food spatters cause excessive smoking.</b> <ul style="list-style-type: none"> <li>• Regular cleaning is necessary when broiling frequently.</li> </ul>
<b>Food does not bake or roast properly</b>	<b>Oven controls improperly set.</b> <ul style="list-style-type: none"> <li>• See the "Oven" section in the Operation chapter.</li> </ul>
	<b>Rack position is incorrect or the rack is not level.</b> <ul style="list-style-type: none"> <li>• See the "Oven" section in the Operation chapter.</li> </ul>
	<b>Incorrect cookware or cookware of improper size being used.</b> <ul style="list-style-type: none"> <li>• See the "Oven" section in the Operation chapter.</li> </ul>
	<b>Oven sensor needs to be adjusted.</b> <ul style="list-style-type: none"> <li>• See the "Calibrating the Oven Temperature" section in the Operation chapter.</li> </ul>
<b>Food does not broil properly</b>	<b>Oven controls improperly set.</b> <ul style="list-style-type: none"> <li>• Make sure you select the <b>Broil</b> mode properly.</li> </ul>
	<b>Improper rack position being used.</b> <ul style="list-style-type: none"> <li>• See the Broiling Guide.</li> </ul>

Problem	Possible Cause & Solution
Food does not broil properly	<b>Cookware not suited for broiling.</b> <ul style="list-style-type: none"> <li>Use broiling pan and grid.</li> </ul>
	<b>Aluminum foil used on the broiling pan and grid has not been fitted properly and slit as recommended.</b> <ul style="list-style-type: none"> <li>See the "Oven" section in the Operation chapter.</li> </ul>
	<b>In some areas the power voltage may be low.</b> <ul style="list-style-type: none"> <li>Preheat the broil element for 5-7 minutes. See the Broiling Guide.</li> </ul>
Oven temperature too hot or too cold	<b>Oven sensor needs to be adjusted.</b> <ul style="list-style-type: none"> <li>See the "Calibrating the Oven Temperature" section in the Operation chapter.</li> </ul>
Excessive smoking during a Self Clean cycle (On some models)	<b>Excessive soil.</b> <ul style="list-style-type: none"> <li>Turn off the Self Clean function. Open the windows to rid the room of smoke. Wait until the Self Clean mode is cancelled. Wipe up the excess soil and reset the clean.</li> </ul>
Burning or oily odor emitting from the vent	<b>This is normal in a new oven.</b> <ul style="list-style-type: none"> <li>This will disappear in time. To speed the process, set a Self Clean cycle for a minimum of 3 hours. See the Self Clean section. (On some models)</li> </ul>
Moisture collects on oven window or steam comes from oven vent	<b>This happens when cooking foods high in moisture.</b> <ul style="list-style-type: none"> <li>This is normal.</li> </ul>
	<b>Excessive moisture was used when cleaning the window.</b> <ul style="list-style-type: none"> <li>Do not use excessive moisture when cleaning the window.</li> </ul>

## Parts & Features

Problem	Possible Cause & Solution
Range is not level.	<b>Poor installation.</b> <ul style="list-style-type: none"> <li>Place oven rack in center of oven. Place a level on the oven rack. Adjust leveling legs at base of range until the oven rack is level.</li> <li>Be sure floor is level and strong and stable enough to adequately support range.</li> <li>If floor is sagging or sloping, contact a carpenter to correct the situation.</li> </ul>
	<b>Kitchen cabinet alignment may make range appear unlevel.</b> <ul style="list-style-type: none"> <li>Be sure cabinets are square and have sufficient room for range clearance.</li> </ul>
Cannot move appliance easily. Appliance must be accessible for service.	<b>Cabinets not square or are built in too tightly.</b> <ul style="list-style-type: none"> <li>Contact builder or installer to make appliance accessible.</li> </ul>
	<b>Carpet interferes with range.</b> <ul style="list-style-type: none"> <li>Provide sufficient space so range can be lifted over carpet.</li> </ul>
	<b>Anti-tip device engaged.</b> <ul style="list-style-type: none"> <li>Uninstall the anti-tip device to move the range. Reengage the anti-tip device after pulling the range out for cleaning, service, or any other reason.</li> </ul>
Surface units will not maintain a rolling boil or cooking is not fast enough.	<b>Improper cookware being used.</b> <ul style="list-style-type: none"> <li>Use pans which are flat and match the diameter of the surface unit selected.</li> </ul>
	<b>In some areas, the power(voltage) may be low.</b> <ul style="list-style-type: none"> <li>Cover pan with a lid until desired heat is obtained.</li> </ul>

Problem	Possible Cause & Solution
Surface units do not work properly.	<b>A fuse in your home may be blown or the circuit breaker tripped.</b> <ul style="list-style-type: none"> <li>Replace the fuse or reset the circuit breaker.</li> </ul>
	<b>Cooktop controls improperly set.</b> <ul style="list-style-type: none"> <li>Check to see the correct control is set for the surface unit you are using.</li> </ul>
Surface unit stops glowing when changed to a lower setting.	<b>The unit is still on and hot.</b> <ul style="list-style-type: none"> <li>This is normal.</li> </ul>
Areas of discoloration on the cooktop	<b>Food spillovers not cleaned before next use.</b> <ul style="list-style-type: none"> <li>See the "Glass-Ceramic Cooktop" section in the MAINTENANCE chapter.</li> </ul>
	<b>Hot surface on a model with a light-colored cooktop.</b> <ul style="list-style-type: none"> <li>This is normal. The surface may appear discolored when it is hot. This is temporary and will disappear as the glass cools.</li> </ul>
Frequent cycling on and off of surface units	<b>The element will cycle on and off to maintain the heat setting.</b> <ul style="list-style-type: none"> <li>This is normal.</li> </ul>
Scratches or abrasions on cooktop surface	<b>Coarse particles such as salt or sand between cooktop and utensils can cause scratches.</b> <ul style="list-style-type: none"> <li>Be sure the cooktop surface and bottoms of utensils are clean before using. Small scratches do not affect cooking and will become less visible with time.</li> </ul>
	<b>Cleaning materials not recommended for glass-ceramic cooktop have been used.</b> <ul style="list-style-type: none"> <li>See the "Glass-Ceramic Cooktop" section in the MAINTENANCE chapter.</li> </ul>
	<b>Cookware with rough bottom has been used.</b> <ul style="list-style-type: none"> <li>Use smooth, flat-bottomed cookware.</li> </ul>
Metal marks	<b>Scraping of metal utensils on cooktop surface.</b> <ul style="list-style-type: none"> <li>Do not slide metal utensils on cooktop surface. Use a glass-ceramic cooktop cleaning creme to remove the marks. See the "Glass-Ceramic Cooktop" section in the MAINTENANCE chapter.</li> </ul>
Brown streaks or specks	<b>Boilovers are cooked onto surface.</b> <ul style="list-style-type: none"> <li>Use a blade scraper to remove soil. See the "Glass-Ceramic Cooktop" section in the MAINTENANCE chapter.</li> </ul>
Areas of discoloration on cooktop	<b>Mineral deposits from water and food.</b> <ul style="list-style-type: none"> <li>Remove using a glass-ceramic cooktop cleaning creme. Use cookware with clean, dry bottoms.</li> </ul>
Oven control beeps and displays any F code error.	<b>Electronic control has detected a fault condition.</b> <ul style="list-style-type: none"> <li>Turn off the oven function you are using to clear the display and stop beeping. Reprogram oven. If fault recurs, record fault number and contact a service agent. <ul style="list-style-type: none"> <li>[Case 1] Code: F-3 Cause: Key short error</li> <li>[Case 2] Code: F-9 Cause: Oven not heating</li> </ul> </li> </ul>
Oven control displays Sb/5b/S6/56 error code.	<b>This code is not an error code. It indicates that the product's Sabbath mode 5b is activated.</b> <ul style="list-style-type: none"> <li>See the "Using the Sabbath Mode" section in the Operation chapter.</li> </ul>

Problem	Possible Cause & Solution
Displayed colon in the clock is flashing	<b>This means that the product has just been plugged in, or that it has experienced a power interruption.</b> <ul style="list-style-type: none"> <li>This is normal. Reset the clock or press any button to stop the flashing.</li> </ul>
CLEAN and door flash in the display (On some models)	<b>The Self Clean cycle has been selected, but the door is not closed.</b> <ul style="list-style-type: none"> <li>Close the oven door.</li> </ul>
Loc is on in the display when you want to cook (On some models)	<b>The oven is locked because of the Control Lock / Lockout feature.</b> <ul style="list-style-type: none"> <li>Deactivate the <b>Control Lock / Lockout</b> feature.</li> </ul>
Oven light does not work.	<b>It is time to replace the lamp or the lamp is loose.</b> <ul style="list-style-type: none"> <li>Replace or tighten lamp. See "Changing the Oven Light" section in this Owner's Manual.</li> </ul>
Convection fan stops. (During Conv.Bake mode)	<b>Convection fan stops during a convection bake cycle. It is done to allow for more even heating during the cycle.</b> <ul style="list-style-type: none"> <li>This is not a failure of the range and should be considered normal operation.</li> </ul>
Fan operation (During Bake mode)	<b>This is to ensure even baking results.</b> <ul style="list-style-type: none"> <li>It is normal for the fan to operate periodically throughout a normal bake cycle in the oven.</li> </ul>
Oven will not Self Clean. (On some models)	<b>The oven temperature is too high to set a Self Clean operation.</b> <ul style="list-style-type: none"> <li>Allow the range to cool and reset the controls.</li> </ul>
	<b>Oven controls improperly set.</b> <ul style="list-style-type: none"> <li>See the Self Clean section.</li> </ul>
	<b>A Self Clean cycle cannot be started if the oven Control Lock / Lockout feature is active.</b> <ul style="list-style-type: none"> <li>See the "Control Lock / Lockout" in "Changing Oven Settings" section.</li> </ul>
Oven door does not open after a Self Clean cycle (On some models)	<b>Oven is too hot.</b> <ul style="list-style-type: none"> <li>Allow the oven to cool below locking temperature.</li> </ul>
	<b>The control and door may be locked.</b> <ul style="list-style-type: none"> <li>Allow about one hour for the oven to cool after the completion of a Self Clean cycle. The door can be opened when the lock  is no longer displayed.</li> </ul>
The oven is not clean after a Self Clean cycle (On some models)	<b>Oven controls not properly set.</b> <ul style="list-style-type: none"> <li>See the Self Clean section.</li> </ul>
	<b>Oven was heavily soiled.</b> <ul style="list-style-type: none"> <li>Clean up heavy spillovers before starting the clean cycle. Heavily soiled ovens may need to Self Clean again or for a longer period of time.</li> </ul>
Oven racks are difficult to slide (On some models)	<b>The shiny, silver-colored racks were cleaned in a Self Clean cycle.</b> <ul style="list-style-type: none"> <li>Apply a small amount of vegetable oil to a paper towel and wipe the edges of the oven racks with the paper towel.</li> </ul>

## Noises

Problem	Possible Cause & Solution
"Crackling" or "popping" sound	<b>This is the sound of the metal heating and cooling during cooking. On models with Self Clean, this can also happen during the Self Clean function.</b> <ul style="list-style-type: none"> <li>This is normal.</li> </ul>
Fan noise	<b>A convection fan may automatically turn on and off.</b> <ul style="list-style-type: none"> <li>This is normal.</li> </ul>

Problem	Possible Cause & Solution
<b>A chime sounds when surface elements are turned on.</b>	<p><b>When any cooktop burner is activated, a chime sounds to indicate the cooktop is in use.</b></p> <ul style="list-style-type: none"> <li>• This is normal.</li> </ul>

## Wi-Fi

Problem	Possible Cause & Solution
<b>Trouble connecting appliance and smartphone to Wi-Fi network</b>	<p><b>The password for the Wi-Fi network was entered incorrectly.</b></p> <ul style="list-style-type: none"> <li>• Delete your home Wi-Fi network and begin the connection process again.</li> </ul>
	<p><b>Mobile data for your smartphone is turned on.</b></p> <ul style="list-style-type: none"> <li>• Turn off the <b>Mobile data</b> on your smartphone before connecting the appliance.</li> </ul>
	<p><b>The wireless network name (SSID) is set incorrectly.</b></p> <ul style="list-style-type: none"> <li>• The wireless network name (SSID) should be a combination of English letters and numbers. (Do not use special characters.)</li> </ul>
	<p><b>The router frequency is not 2.4 GHz.</b></p> <ul style="list-style-type: none"> <li>• Only a 2.4 GHz router frequency is supported. Set the wireless router to 2.4 GHz and connect the appliance to the wireless router. To check the router frequency, check with your Internet service provider or the router manufacturer.</li> </ul>
	<p><b>The appliance and the router are too far apart.</b></p> <ul style="list-style-type: none"> <li>• If the appliance is too far from the router, the signal may be weak and the connection may not be configured correctly. Move the router closer to the appliance or purchase and install a Wi-Fi repeater.</li> </ul>
	<p><b>During Wi-Fi setup, the app is requesting a password to connect to the product (on certain phones).</b></p> <ul style="list-style-type: none"> <li>• Locate the network name which starts with "LG" under Settings &gt; Networks. Note the last part of the network name. <ul style="list-style-type: none"> <li>- If the network name looks like LGE_Appliance_XX-XX-XX, enter lge12345.</li> <li>- If the network name looks like LGE_Appliance_XXXX, enter XXXX twice as your password. For example, if the network name appears as LGE_Appliance_8b92, then you would enter 8b928b92 as your password. In this instance, the password is case sensitive and the last 4 characters are unique to your appliance.</li> </ul> </li> </ul>

# LIMITED WARRANTY

## USA

### TERMS AND CONDITIONS

**ARBITRATION NOTICE: THIS LIMITED WARRANTY CONTAINS AN ARBITRATION PROVISION THAT REQUIRES YOU AND LG ELECTRONICS (“LG”) TO RESOLVE DISPUTES BY BINDING ARBITRATION INSTEAD OF IN COURT, UNLESS YOU CHOOSE TO OPT OUT. IN ARBITRATION, CLASS ACTIONS AND JURY TRIALS ARE NOT PERMITTED. PLEASE SEE THE SECTION TITLED “PROCEDURE FOR RESOLVING DISPUTES” BELOW.**

Should your LG Electric Range (“Product”) fail due to a defect in materials or workmanship under normal and proper use, during the warranty period set forth below, LG will, at its option, repair or replace the Product. This limited warranty is valid only to the original retail purchaser of the Product (“You”) and applies only when purchased lawfully and used within the United States including U.S. Territories.

Warranty Period	Scope of Warranty	HOW SERVICE IS HANDLED
One (1) year from the date of original retail purchase, or from the date of delivery as per applicable law	Parts and Labor (internal / functional parts only)	LG will provide, free of charge, all labor and in-home service to replace defective part(s).

- Replacement Products and parts are warranted for the remaining portion of the original warranty period or ninety (90) days, whichever is greater.
- Replacement Products and parts may be new, reconditioned, refurbished, or otherwise factory remanufactured.
- Replaced Product or part(s) will be the property of LG.
- Proof of original retail purchase specifying the Product model and date of purchase is required to obtain warranty service under this limited warranty.

**EXCEPT TO THE EXTENT PROHIBITED BY APPLICABLE LAW, ANY IMPLIED WARRANTY OF MERCHANTABILITY OR FITNESS FOR A PARTICULAR PURPOSE ON THE PRODUCT IS LIMITED IN DURATION TO THE DURATION OF THE ABOVE LIMITED WARRANTY. UNDER NO CIRCUMSTANCES SHALL LG OR ITS U.S. DISTRIBUTORS/DEALERS BE LIABLE FOR ANY INDIRECT, INCIDENTAL, CONSEQUENTIAL, SPECIAL, OR PUNITIVE DAMAGES, INCLUDING, WITHOUT LIMITATION, LOST GOODWILL, LOST REVENUES OR PROFITS, WORK STOPPAGE, IMPAIRMENT OF OTHER GOODS, COST OF REMOVAL AND REINSTALLATION OF THE PRODUCT, LOSS OF USE, OR ANY OTHER DAMAGES WHETHER BASED IN CONTRACT, TORT, OR OTHERWISE. LG’S TOTAL LIABILITY, IF ANY, SHALL NOT EXCEED THE PURCHASE PRICE PAID BY YOU FOR THE PRODUCT.**

**SOME STATES DO NOT ALLOW THE EXCLUSION OR LIMITATION OF INCIDENTAL OR CONSEQUENTIAL DAMAGES OR LIMITATIONS ON HOW LONG AN IMPLIED WARRANTY LASTS, SO THE ABOVE EXCLUSIONS OR LIMITATIONS MAY NOT APPLY TO YOU. THIS LIMITED WARRANTY GIVES YOU SPECIFIC LEGAL RIGHTS AND YOU MAY ALSO HAVE OTHER RIGHTS THAT VARY FROM STATE TO STATE.**

### THIS LIMITED WARRANTY DOES NOT COVER:

- Service trips to deliver, pick up, or install, educate how to operate, correct wiring, or correct unauthorized repairs.
- Damage or failure of the Product to perform during power failures and interrupted or inadequate electrical service.
- Damage or failure of the Product caused by leaky or broken water pipes, frozen water pipes, restricted drain lines, inadequate or interrupted water supply or inadequate supply of air.
- Damage or failure of the Product resulting from operating the Product in a corrosive atmosphere or contrary to the Product owner’s manual.

- Damage or failure of the Product caused by accidents, pests and vermin, lightning, wind, fire, floods, acts of nature, or any other causes beyond the control of LG.
- Damage or failure of the Product caused by unauthorized modification or alteration, or if the Product is used for other than the intended purpose, or any water leakage where the Product was not properly installed.
- Damage or failure of the Product caused by incorrect electrical current, voltage, or plumbing codes.
- Damage or failure of the Product caused by transportation, storage, and/or handling, including scratches, dents, chips, and/or other damage to the finish of the Product, unless such damage is reported within one (1) week of delivery.
- Damage or failure of the Product resulting from misuse, abuse, improper installation, repair, or maintenance. Improper repair includes the use of parts not authorized by LG. Improper installation or maintenance includes installation or maintenance contrary to the Product owner's manual.
- Damage or failure of the Product caused by the use of parts, components, accessories, consumable cleaning products, or any other products or services that were not authorized by LG.
- Damage or missing items to any display or open box Product.
- Refurbished Product or any Product sold "As Is", "Where Is", "With all Faults", or similar disclaimer.
- Products with original serial numbers that have been removed, altered, or cannot be readily determined.
- Increases in utility costs and additional utility expenses.
- Any noises associated with normal operation.
- Products used for other than normal and proper household use (e.g., commercial, business, or industrial settings, including any retail or food service establishments, or any commercial lodging/transient rental setting), or any use contrary to the Product owner's manual.
- Costs associated with removal and reinstallation of the Product for repairs, or the removal and reinstallation of the Product if it is installed in an inaccessible location or not installed in accordance with the Product Owner's manual.
- Accessories, removable components, or consumable parts (e.g. Shelves, door bins, drawers, water/air filters, racks, light bulbs, batteries, etc., as applicable), except for internal/functional parts covered under this limited warranty.

## Not Covered by this Limited Warranty

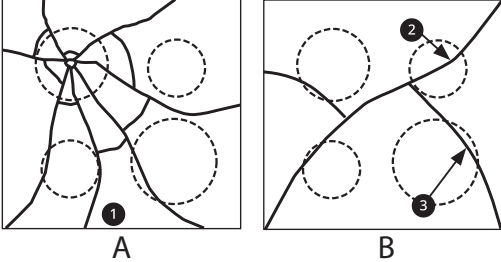
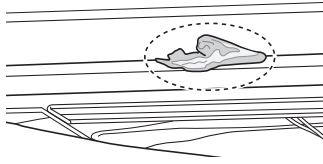
Problem	Possible Cause & Prevention
<p><b>Cooktop crack</b></p>	<p><b>Cooktop crack caused by impact of object</b></p> <div style="text-align: center;">  <p>A                      B</p> </div> <ul style="list-style-type: none"> <li>• A: Out of warranty <ul style="list-style-type: none"> <li>- ❶ Mechanical breakage</li> </ul> </li> <li>• B: In warranty <ul style="list-style-type: none"> <li>- ❷ Primary crack ❸ Secondary crack</li> </ul> </li> <li>• DO NOT store heavy items above the cooktop surface as they could fall and damage it.</li> <li>• DO NOT scratch the cooktop or the cooktop could crack.</li> <li>• Clean the cooktop before and after using.</li> </ul> <p><b>NOTE</b></p> <ul style="list-style-type: none"> <li>• Damage caused after delivery (Not covered by warranty)</li> </ul>
<p><b>Cooktop enamel chipping off</b></p>	<p><b>Improper usage</b></p> <div style="text-align: center;">  </div> <ul style="list-style-type: none"> <li>• Do not hit enamel cooktop.</li> </ul>
<p><b>Pitting of the cooktop glass</b></p>	<p><b>If not removed immediately, sugary spillovers (such as preserves, ketchup, tomato sauce, jellies, fudge, candy, syrups, or chocolate) or melted plastic or foil can cause surface pitting of the cooktop. (Not covered by warranty)</b></p> <ul style="list-style-type: none"> <li>• Remove the molten material IMMEDIATELY with a metal razor scraper.</li> <li>• For safety, wear an oven mitt or hot pad while scraping the hot surface.</li> </ul>

Problem	Possible Cause & Prevention
<p><b>Unit has no power</b></p>	<p><b>1. House power turned off (power supply)</b></p> <ul style="list-style-type: none"> <li>• Check power at main board before calling for service.</li> </ul> <p><b>2. Tripped breaker</b></p> <ul style="list-style-type: none"> <li>• Match power cord type and outlet type.</li> </ul> <p><b>3. The power cord is not installed properly.</b></p> <ul style="list-style-type: none"> <li>• Properly install the power cord.</li> </ul> <div data-bbox="536 388 1068 774" style="text-align: center;"> <p>A &lt;NEMA 10-50&gt;</p> <p>B &lt;NEMA 14-50&gt;</p> </div> <ul style="list-style-type: none"> <li>• A: 3-WIRE HOOK UP</li> <li>• B: 4-WIRE HOOK UP</li> <li>• ① Black ② White ③ Red ④ Outer wire</li> <li>• ⑤ Center wire (neutral) ⑥ Black wire</li> <li>• ⑦ Green ground wire ⑧ White wire (neutral)</li> <li>• ⑨ Red wire ⑩ Ground strap ⑪ Remove ground strap</li> </ul>
<p><b>Oven or racks are stained after using aluminum foil</b></p>	<p><b>Aluminum foil has melted in the oven</b></p> <div data-bbox="686 1062 905 1159" style="text-align: center;"> </div> <ul style="list-style-type: none"> <li>• Never cover the oven bottom or cover an entire rack with materials such as aluminum foil.</li> <li>• If the foil has already melted onto the oven, it will not affect the performance of the oven.</li> </ul>

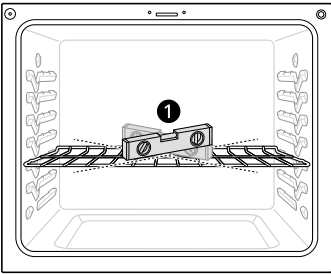
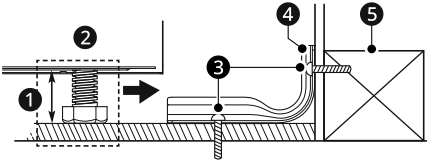
Problem	Possible Cause & Prevention
<p><b>Surface is not level</b> <b>Oven is tipping</b></p>	<p><b>Range not leveled</b></p>  <ul style="list-style-type: none"> <li>• Check with installer first.</li> <li>• Use carpenter's level ❶ to check level.</li> </ul> <p><b>Anti-tip device not installed correctly</b></p>  <ul style="list-style-type: none"> <li>❶ Approximately 0.65" (16.5 mm)</li> <li>❷ Level both sides of range</li> <li>❸ Screw must enter wood or concrete</li> <li>❹ Anti-tip bracket</li> <li>❺ Wall plate</li> </ul> <ul style="list-style-type: none"> <li>• Check with installer first.</li> </ul>

**The cost of repair or replacement under these excluded circumstances shall be borne by You.**

TO OBTAIN WARRANTY SERVICE AND ADDITIONAL INFORMATION

Call [1-800-243-0000](tel:1-800-243-0000) and select the appropriate option from the menu.

Or visit our website at <http://www.lg.com>

Or by mail: LG Electronics Customer Service P.O. Box 240007 Huntsville, AL 35813 ATTN: CIC

## PROCEDURE FOR RESOLVING DISPUTES:

ALL DISPUTES BETWEEN YOU AND LG ARISING OUT OF OR RELATING IN ANY WAY TO THIS LIMITED WARRANTY OR THE PRODUCT SHALL BE RESOLVED EXCLUSIVELY THROUGH BINDING ARBITRATION, AND NOT IN A COURT OF GENERAL JURISDICTION. BINDING ARBITRATION MEANS THAT YOU AND LG ARE EACH WAIVING THE RIGHT TO A JURY TRIAL AND TO BRING OR PARTICIPATE IN A CLASS ACTION.

**Definitions.** For the purposes of this section, references to "LG" mean LG Electronics U.S.A., Inc., its parents, subsidiaries and affiliates, and each of their officers, directors, employees, agents, beneficiaries, predecessors in interest, successors, assigns and suppliers; references to "dispute" or "claim" shall include any dispute, claim or controversy of any kind whatsoever (whether based in contract, tort, statute, regulation, ordinance, fraud, misrepresentation or any other legal or equitable theory) arising out of or relating in any way to the sale, condition or performance of the product or this Limited Warranty.

**Notice of Dispute.** In the event you intend to commence an arbitration proceeding, you must first notify LG in writing at least 30 days in advance of initiating the arbitration by sending a letter to LG at LG Electronics, USA, Inc. Attn: Legal Department- Arbitration 111 Sylvan Avenue, Englewood Cliffs, NJ 07632. You and LG agree to engage in good faith discussions in an attempt to amicably resolve your claim. The notice must provide your name, address, and telephone number; identify the product that is the subject of

the claim; and describe the nature of the claim and the relief being sought. If you and LG are unable to resolve the dispute within 30 days, either party may proceed to file a claim for arbitration.

**Agreement to Binding Arbitration and Class Action Waiver.** Upon failure to resolve the dispute during the 30 day period after sending written notice to LG, you and LG agree to resolve any claims between us only by binding arbitration on an individual basis, unless you opt out as provided below. Any dispute between you and LG shall not be combined or consolidated with a dispute involving any other person's or entity's product or claim. More specifically, without limitation of the foregoing, any dispute between you and LG shall not under any circumstances proceed as part of a class or representative action. Instead of arbitration, either party may bring an individual action in small claims court, but that small claims court action may not be brought on a class or representative basis.

**Arbitration Rules and Procedures.** To begin arbitration of a claim, either you or LG must make a written demand for arbitration. The arbitration will be administered by the American Arbitration Association ("AAA") and will be conducted before a single arbitrator under the AAA's Consumer Arbitration Rules that are in effect at the time the arbitration is initiated (referred to as the "AAA Rules") and under the procedures set forth in this section. The AAA Rules are available online at [www.adr.org/consumer](http://www.adr.org/consumer). Send a copy of your written demand for arbitration, as well as a copy of this provision, to the AAA in the manner described in the AAA Rules. You must also send a copy of your written demand to LG at LG Electronics, USA, Inc. Attn: Legal Department- Arbitration 111 Sylvan Avenue, Englewood Cliffs, NJ 07632. If there is a conflict between the AAA Rules and the rules set forth in this section, the rules set forth in this section will govern. This arbitration provision is governed by the Federal Arbitration Act. Judgment may be entered on the arbitrator's award in any court of competent jurisdiction. All issues are for the arbitrator to decide, except that issues relating to the scope and enforceability of the arbitration provision and to the arbitrability of the dispute are for the court to decide. The arbitrator is bound by the terms of this provision.

**Governing Law.** The law of the state of your residence shall govern this Limited Warranty and any disputes between us except to the extent that such law is preempted by or inconsistent with applicable federal law.

**Fees/Costs.** You do not need to pay any fee to begin an arbitration. Upon receipt of your written demand for arbitration, LG will promptly pay all arbitration filing fees to the AAA unless you seek more than \$25,000 in damages, in which case the payment of these fees will be governed by the AAA Rules. Except as otherwise provided for herein, LG will pay all AAA filing, administration and arbitrator fees for any arbitration initiated in accordance with the AAA Rules and this arbitration provision. If you prevail in the arbitration, LG will pay your attorneys' fees and expenses as long as they are reasonable, by considering factors including, but not limited to, the purchase amount and claim amount. Notwithstanding the foregoing, if applicable law allows for an award of reasonable attorneys' fees and expenses, an arbitrator can award them to the same extent that a court would. If the arbitrator finds either the substance of your claim or the relief sought in the demand is frivolous or brought for an improper purpose (as measured by the standards set forth in Federal Rule of Civil Procedure 11(b)), then the payment of all arbitration fees will be governed by the AAA Rules. In such a situation, you agree to reimburse LG for all monies previously disbursed by it that are otherwise your obligation to pay under the AAA Rules. Except as otherwise provided for, LG waives any rights it may have to seek attorneys' fees and expenses from you if LG prevails in the arbitration.

**Hearings and Location.** If your claim is for \$25,000 or less, you may choose to have the arbitration conducted solely on the basis of (1) documents submitted to the arbitrator, (2) through a telephonic hearing, or (3) by an in-person hearing as established by the AAA Rules. If your claim exceeds \$25,000, the right to a hearing will be determined by the AAA Rules. Any in-person arbitration hearings will be held at a location within the federal judicial district in which you reside unless we both agree to another location or we agree to a telephonic arbitration.

**Opt Out.** You may opt out of this dispute resolution procedure. If you opt out, neither you nor LG can require the other to participate in an arbitration proceeding. To opt out, you must send notice to LG no later than 30 calendar days from the date of the first consumer purchaser's purchase of the product by either: (i) sending an e-mail to [optout@lge.com](mailto:optout@lge.com), with the subject line: "Arbitration Opt Out" or (ii) calling 1-800-980-2973. You must include in the opt out e-mail or provide by telephone: (a) your name and address; (b) the date on which the product was purchased; (c) the product model name or model number; and (d) the serial number (the serial number can be found (i) on the product; or (ii) online by accessing <https://www.lg.com/us/support> and clicking on "How do I find my model number?").

You may only opt out of the dispute resolution procedure in the manner described above (that is, by e-mail or telephone); no other form of notice will be effective to opt out of this dispute resolution procedure. Opting out of this dispute resolution procedure will not affect the coverage of the Limited Warranty in any way, and you will continue to enjoy the full benefits of the Limited Warranty. If you keep this product and do not opt out, then you accept all terms and conditions of the arbitration provision described above.

# Memo

# Memo

# Memo



**LG Customer Information Center**

For inquiries or comments, visit **www.lg.com** or call:

**1-800-243-0000** U.S.A.

**1-888-542-2623** CANADA

Register your product Online!

**www.lg.com**

**Centro de Información al Cliente LG**

Para consultas o comentarios, visite **www.lg.com** o llame por teléfono:

**1-800-243-0000** EE.UU.

**1-888-542-2623** CANADÁ

¡Registre su producto en línea!

**www.lg.com**

**Centre de Service à la Clientèle de LG**

Pour des questions ou des commentaires, visitez **www.lg.com/ca\_fr** ou appelez :

**1-800-243-0000** ÉTATS-UNIS

**1-888-542-2623** CANADA

Enregistrez votre produit en ligne!

**www.lg.com/ca\_fr**