

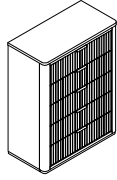
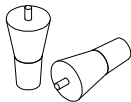

ASSEMBLY INSTRUCTIONS INSTRUCCIONES

B1400-4/B1450-4 CHEST B1400-4/B1450-4 CAJONERO

PART LIST:

NO.	DESCRIPTION	OUTLOOK	QT.
1	CHEST		1
2	BUN FOOT		4

ANTI-TIPPING HARDWARE LIST:

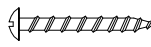
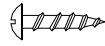
NO.	DESCRIPTION	OUTLOOK	SIZE	QT.
A	BRACKET		1/2"x1"L	2
B	TIE WRAP		#6x11-3/8"L	1
C	LONG SCREW		#8x2"L	1
D	SHORT SCREW		#8x5/8"L	1

ASSEMBLY TOOL
NOT INCLUDED

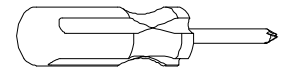

STEP 1

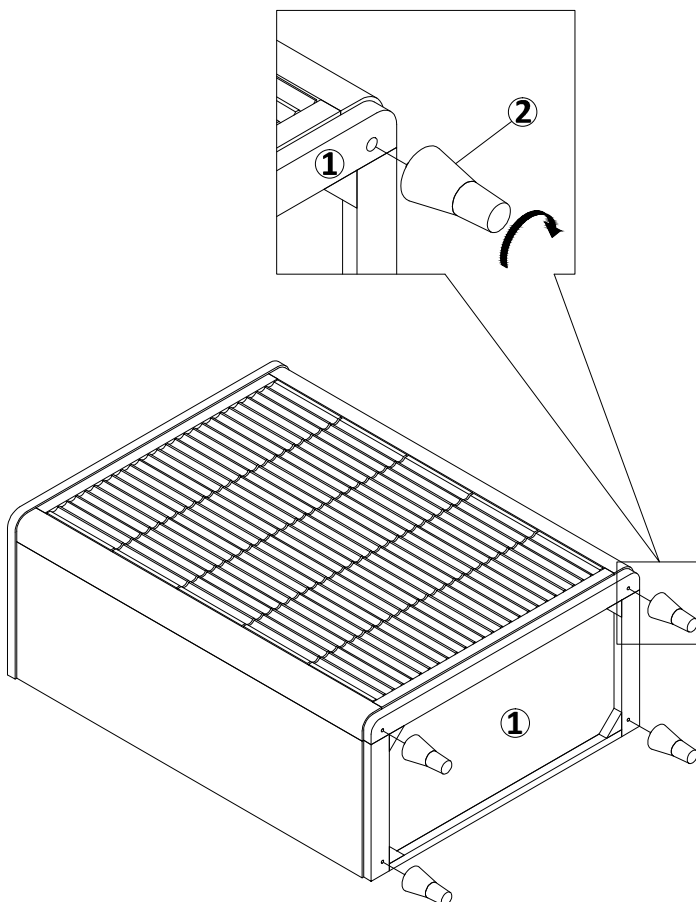

STEP 2

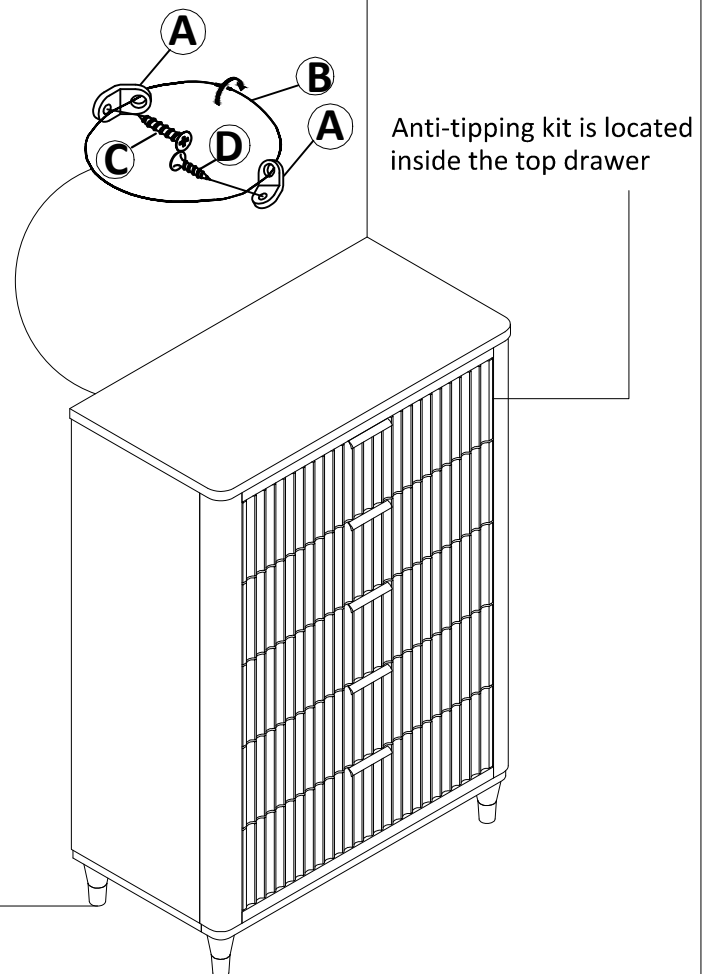

**DO NOT TIGHTEN ALL BOLTS UNTIL COMPLETELY ASSEMBLED.
NO APRETAR LOS TORNILLOS HASTA ARMAR COMPLETAMENTE.**