







ASSEMBLY INSTRUCTIONS

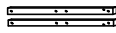

ITEM NO : B3400-2

TILSTON NIGHT STAND W/BACK PANEL



BOX OF NIGHT STAND

ITEM	DRAWING	DESCRIPTION	QTY
A		NIGHT STAND	1
B		LEG (Packed underneath bottom panel)	4
C		BACK PANEL	1
D		CENTER PANEL	1
E		SIDE PANEL (LEFT & RIGHT)	2
F		BACK SUPPORT	2
G		TIPPING RESTRAINT (Affix to wall behind Night Stand) * Located in the Night Stand 1st Drawer	1





TO ATTACHED THE NIGHT STAND TO THE BED
(BECOME A WALL BED)
QUEEN BED (H) OR KING BED (I)

ITEM	DRAWING	DESCRIPTION	QTY
H		QUEEN BED	1
OR			
I		KING BED	1

BOX OF NIGHT STAND HARDWARE LIST FOR THE NIGHT STAND LEG (INSIDE LEG BOX)

ITEM	DRAWING	DESCRIPTION	QTY
1		JCBC BOLT WITH SPRING WASHER AND FLAT WASHER (M6 x 60mm)	8
2		ALLEN KEY (M4)	1

HARDWARE LIST FOR THE NIGHT STAND BACK PANEL (INSIDE BACK PANEL BOX)

ITEM	DRAWING	DESCRIPTION	QTY
3		JCBC BOLT WITH SPRING WASHER AND FLAT WASHER (M6 x 40mm)	11
4		FITTING SYSTEM 5 (05656.885 + 05137.880)	6
5		METAL PLATE (68 x 19 x 2mm)	2
6		JCBC BOLT WITH SPRING WASHER AND FLAT WASHER (M6 x 16mm)	4
7		ALLEN KEY (M4)	1

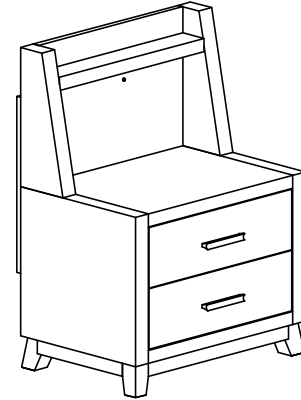

**COMPLETED NIGHT STAND
W/BACK PANEL ASSEMBLY**

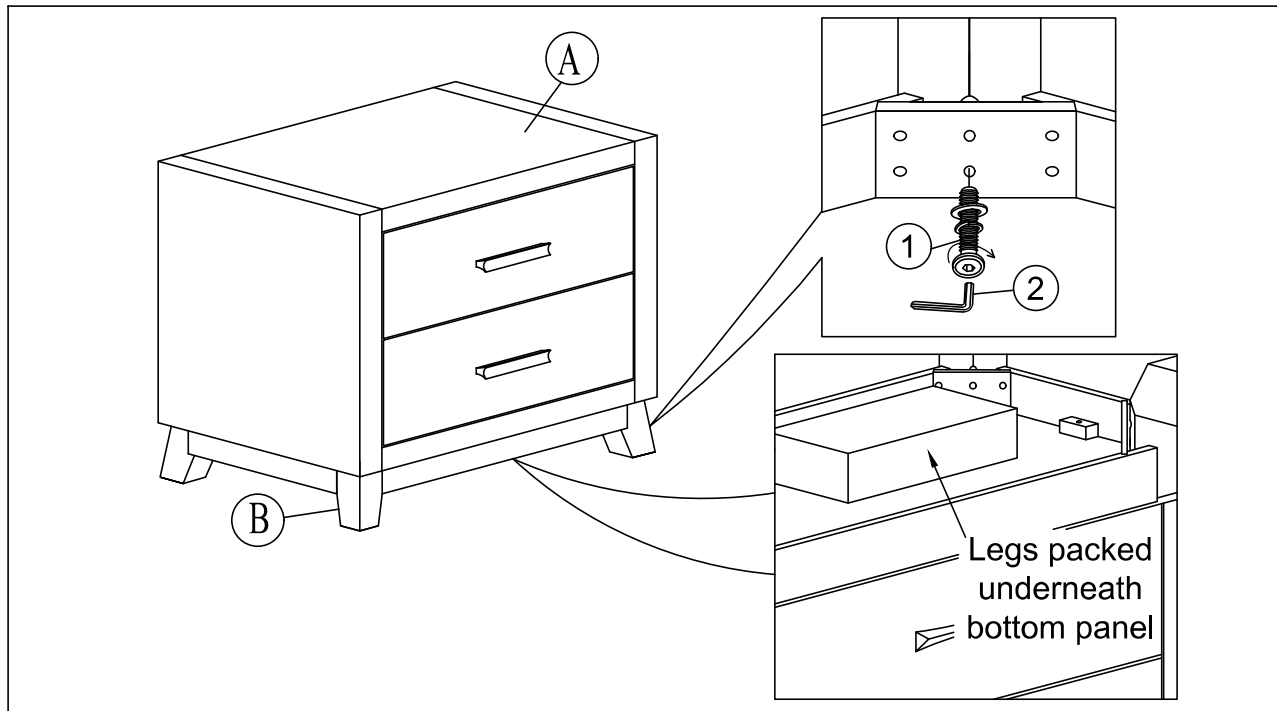
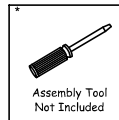

THE HARDWARE IS LOCATED IN THE PACKING ITEMS
THE ANTI TIPPING HARDWARE IS LOCATED IN THE NIGHTSTAND 1ST DRAWER

NOTE : MUST TIGHTEN SCREWS PERIODICALLY. WITH USE SCREWS MAY BECOME LOOSE.
CHECK TIGHTNESS OF ALL SCREWS EVERY 6-8 WEEKS.

CLEANING INSTRUCTION

After assembled, clean & polish the completed parts if necessary with soft cloth and industrial recognized furniture polish

MADE IN MALAYSIA

ASSEMBLY INSTRUCTIONS

ITEM NO : B3400-2

TILSTON NIGHTSTAND W/BACK PANEL

STEP 1:

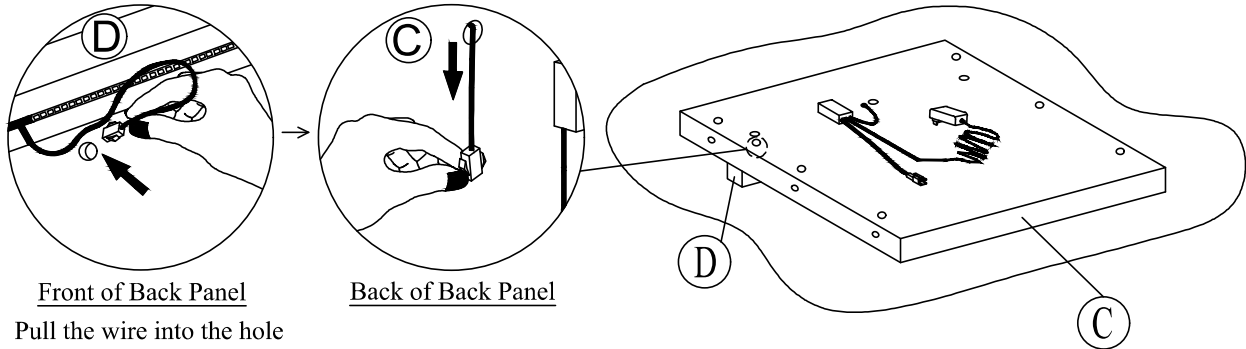

STEP 2:

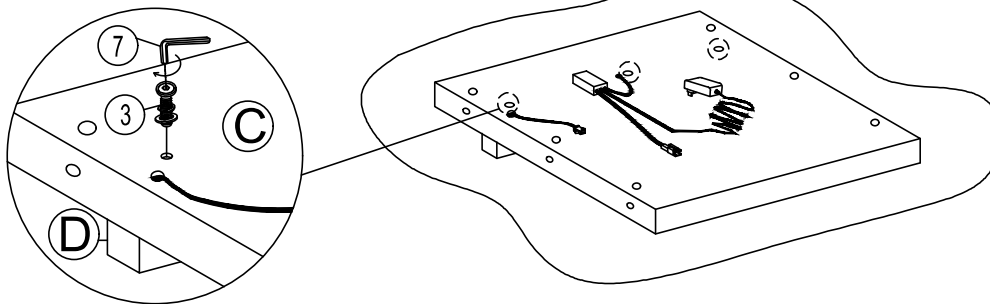

STEP 3:

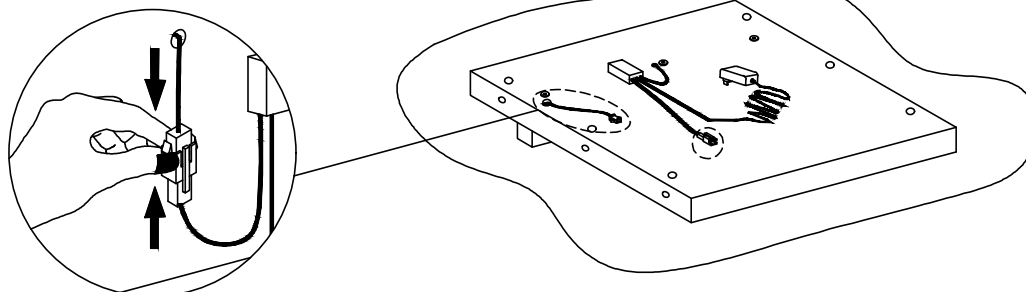

THE HARDWARE IS LOCATED IN THE PACKING ITEMS
THE ANTI TIPPING HARDWARE IS LOCATED IN THE NIGHTSTAND 1ST DRAWER

NOTE : MUST TIGHTEN SCREWS PERIODICALLY. WITH USE SCREWS MAY BECOME LOOSE.
CHECK TIGHTNESS OF ALL SCREWS EVERY 6-8 WEEKS.

CLEANING INSTRUCTION

After assembled, clean & polish the completed parts if necessary with soft cloth and industrial recognized furniture polish

MADE IN MALAYSIA

ASSEMBLY INSTRUCTIONS

ITEM NO : B3400-2

TILSTON NIGHTSTAND W/BACK PANEL

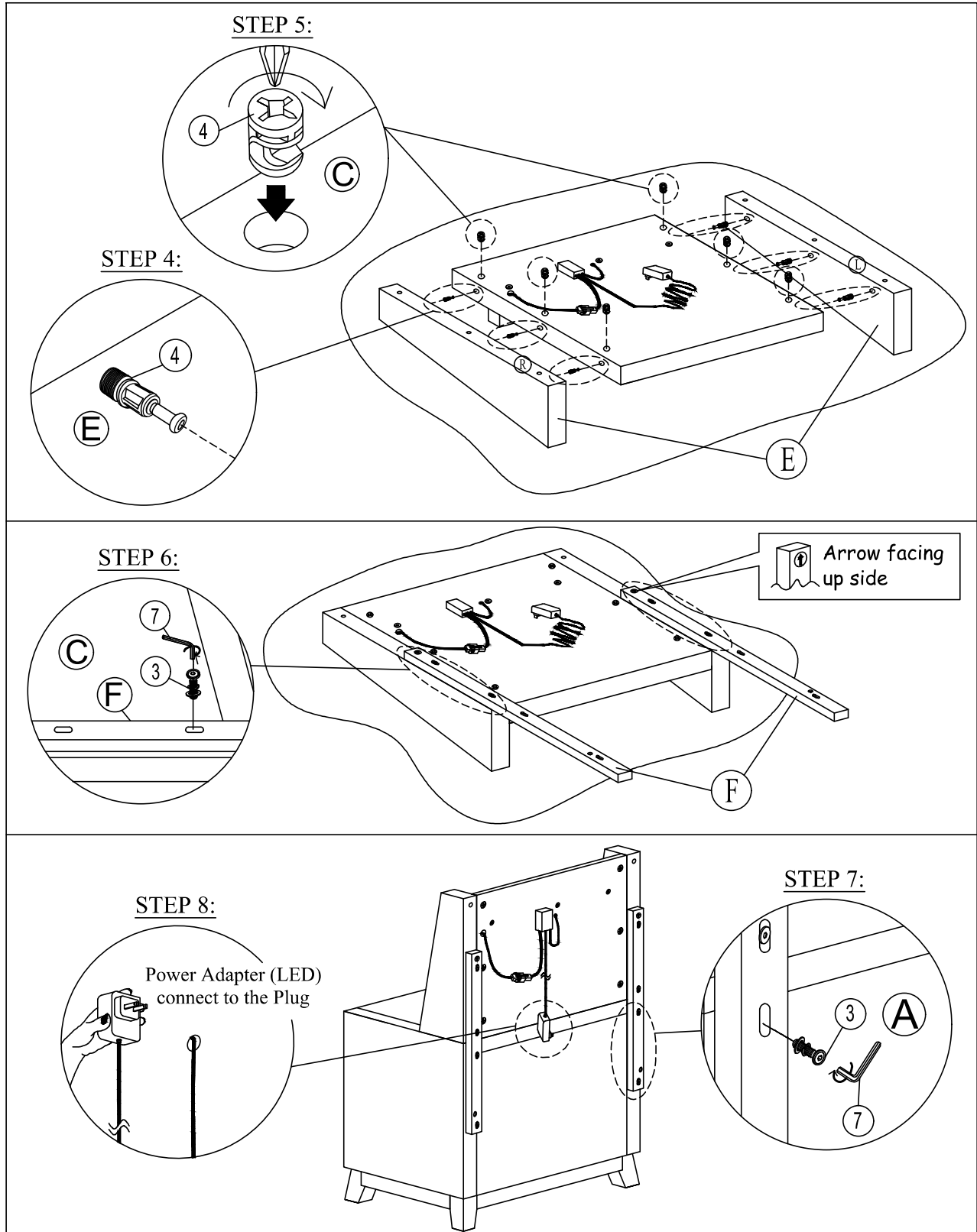

THE HARDWARE IS LOCATED IN THE PACKING ITEMS
THE ANTI TIPPING HARDWARE IS LOCATED IN THE NIGHTSTAND 1ST DRAWER

NOTE : MUST TIGHTEN SCREWS PERIODICALLY. WITH USE SCREWS MAY BECOME LOOSE.
CHECK TIGHTNESS OF ALL SCREWS EVERY 6-8 WEEKS.

CLEANING INSTRUCTION

After assembled, clean & polish the completed parts if necessary with soft cloth and industrial recognized furniture polish

MADE IN MALAYSIA

ASSEMBLY INSTRUCTIONS

ITEM NO : B3400-2

TILSTON NIGHTSTAND W/BACK PANEL

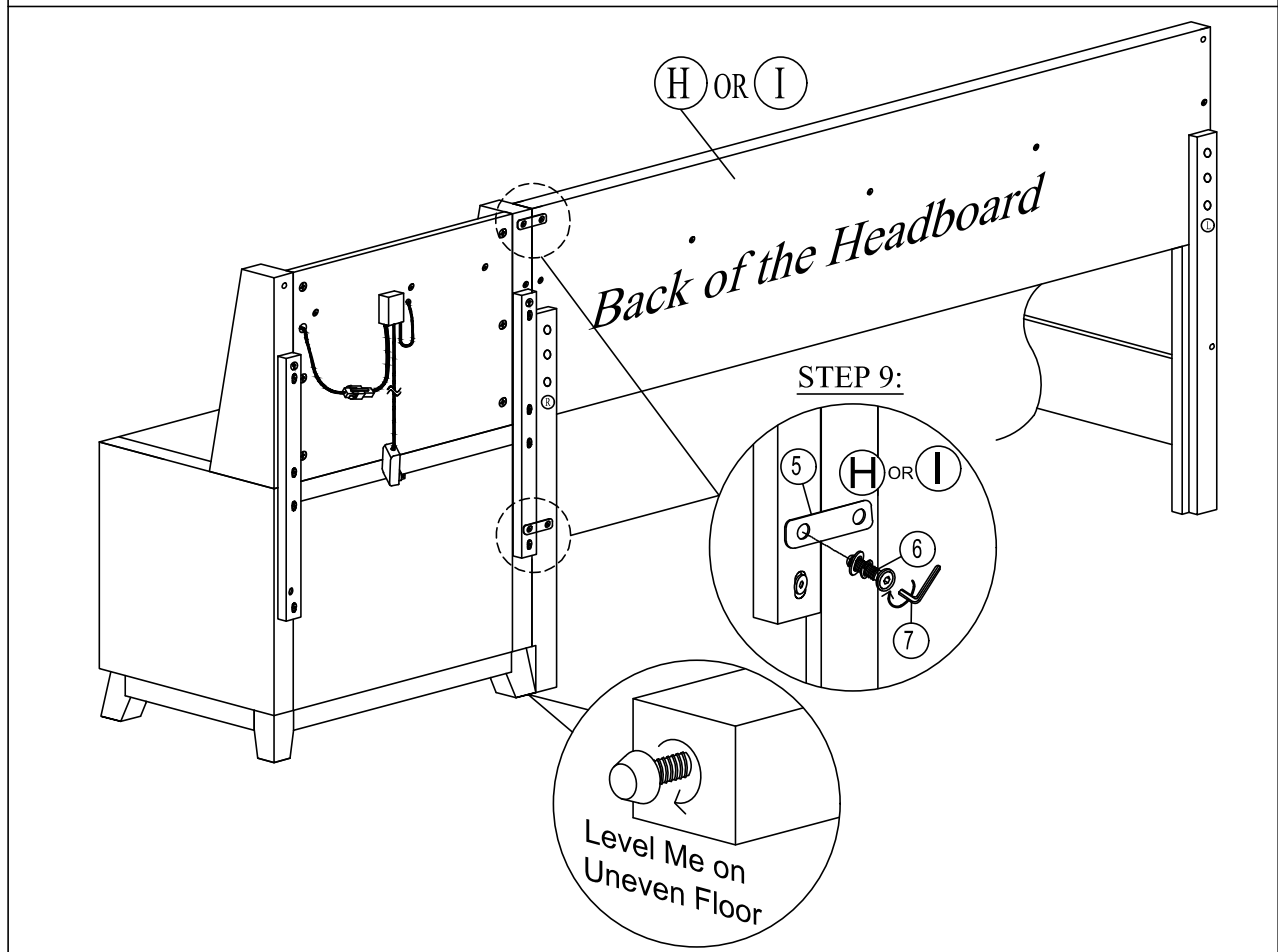
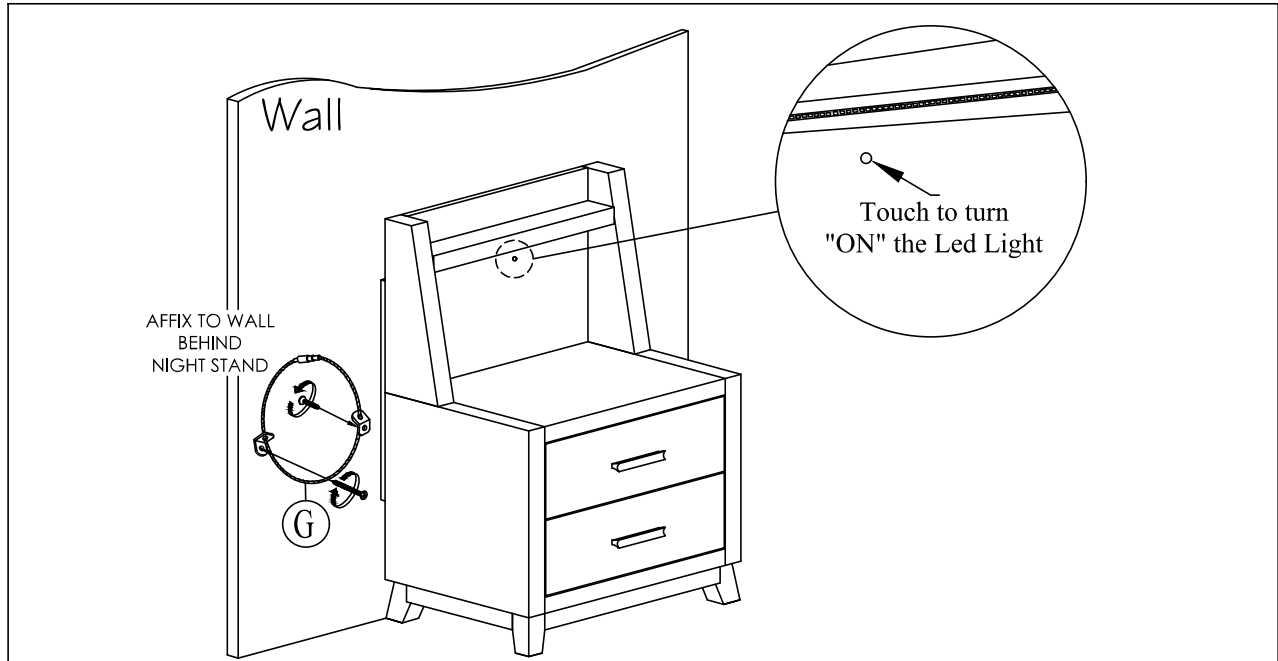

THE HARDWARE IS LOCATED IN THE PACKING ITEMS
THE ANTI TIPPING HARDWARE IS LOCATED IN THE NIGHTSTAND 1ST DRAWER

NOTE : MUST TIGHTEN SCREWS PERIODICALLY. WITH USE SCREWS MAY BECOME LOOSE.
CHECK TIGHTNESS OF ALL SCREWS EVERY 6-8 WEEKS.

CLEANING INSTRUCTION

After assembled, clean & polish the completed parts if necessary with soft cloth and industrial recognized furniture polish

MADE IN MALAYSIA