

CORNUFÉ EUCLID: CH3630EUC & CH4430EUC

SPECIFICATIONS

Models:

36" & 44"

Hood Style:

Trapezoid

Product Dimensions:

Hood Width x Depth x Height

36"W x 24"D x 30"H (600 cfm/8" collar)

44"W x 24"D x 30"H (1200 cfm/10" collar)

Duct Cover Options

12", 24" and 48" Tall

Custom Duct Cover heights are available

Product Weight:

36"(30"H) : 98 lbs

44"(30"H) : 126 lbs

Electrical Requirements:

600 CFM models draw approx. 2.7 Amps

1200 CFM models draw approx. 5.4 Amps

Hood Sone Level:

Ranges from 5-7

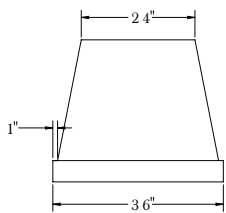

FRONT VIEW

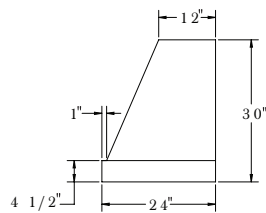

SIDE VIEW

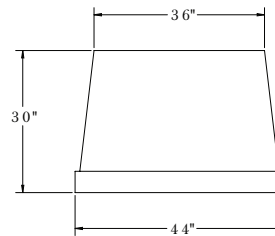

FRONT VIEW

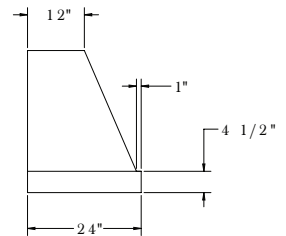

SIDE VIEW

COLOR & TRIM FINISHES

Five Classic Colors: Matte Black, Stainless Steel, Gloss Black, Provence Blue, and Pure White

Four Étoile Colors: Morning Dew, Graphite, Ocean, and Wintersky

Three Trim Options: Polished Brass, Satin Chrome, and Polished Chrome

CORNUFÉ EUCLID: CH3630EUC & CH4430EUC

PRODUCT FEATURES

Quiet Operation

Large 3 speed blower operates at lower RPM reducing the sound level.

Lighting

Bright LED lighting offers natural looking, 3000K color spectrum. The 36" hood features 2 lights, the 44" hood features 2 lights.

Ease of Operation

Electronic touch controls for 3 speed blower and LED lights.

Easy Cleaning

Dishwasher safe, commercial style baffle filters for effectively removing airborne contaminants.

Detergent inlet holes and grease exit holes in baffle filters for superior dishwasher cleaning.

Flexible Installation

Mounting bars at top and bottom allow for attaching to stud supports. Open top and back design for centered duct location or offset top duct and/or rear offset discharge.

Energy Efficient Operation

LED light bulbs draw only 6 watts each and energy efficient motors draw only 2.5 amps.

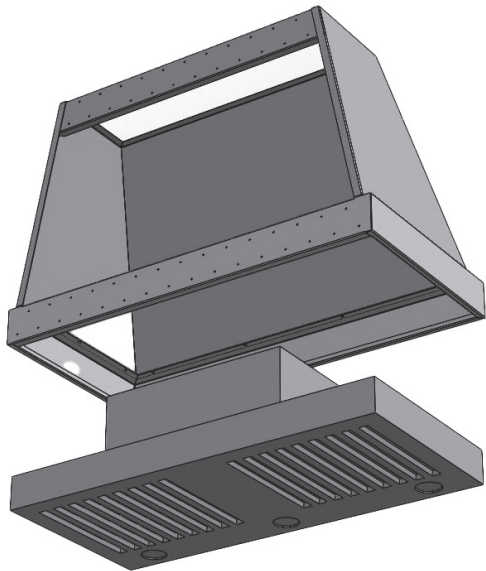

Rear view showing liner is easily removed and reinstalled for simply mounting of hood shell to the wall

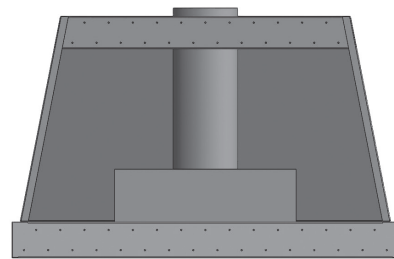

Rear view of standard, centered top venting. Open top design allowing simple R/L offset top ducting

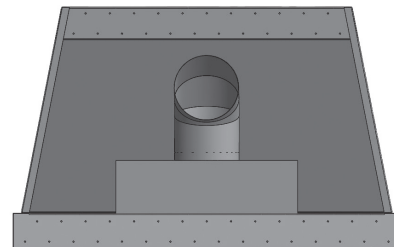

Rear view of standard, centered rear venting. Open back design allowing simple R/L offset rear ducting