

Simple User Guide

HW-LS50H / HW-LS51H



You can access the User guide on Samsung's on-line customer support center by scanning the QR code. To see the manual on your PC or mobile device, download the manual in document format from Samsung's website. (<http://www.samsung.com/support>)

- Figures and illustrations in this User Manual are provided for reference only and may differ from actual product appearance.
- An administration fee may be charged if either:
 - An engineer is called out to your home at your request and there is no defect in the product.
 - You bring the unit to a repair center and there is no defect in the product.
- You will be advised of the amount of the administration fee before any work is done or a home visit is made.
- If you have a problem with this product, we strongly recommend you read the appropriate section of this manual, visit the Support page for your product at www.samsung.com, or call Samsung Product Support (1-800-726-7864) to find an answer before you contact a service center for a repair.

QUESTIONS OR COMMENTS?

Samsung Service Center
 ☎ 1-800-SAMSUNG (726-7864)
Website www.samsung.com/support



01 Checking the Components

- WiFi Speaker
- AC/DC Adapter
- Power Cord

NOTE

- To purchase additional components or optional cables, contact a Samsung Service Center or Samsung Customer Care.

02 Product Overview

Front

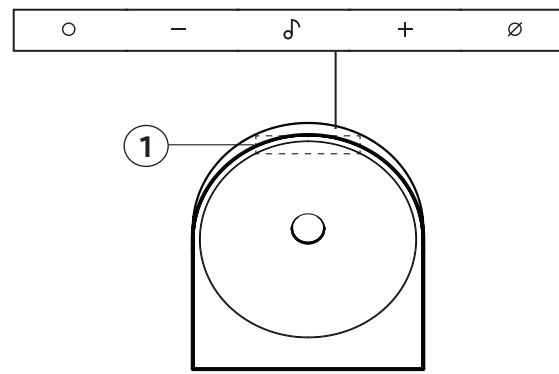

(Multi Function) Button

In standby mode, press the **(Multi Function)** button to turn on the WiFi Speaker. Press the **(Multi Function)** button to change the mode.

(Instant Play) button

The music that was playing can be resumed instantly.

- Press the button to play or pause.
- Press the button twice to skip to the next track.

* When **Spotify Tap** is selected in the **Instant Music Play settings** of the **Samsung Sound** app, the shortcut button is assigned accordingly. In this mode, pressing the button twice launches Spotify and plays a track recommended for your listening preferences.

(Volume) Button

(Mic On/Off) Button

- Press the button to turn the microphone on or off. When the microphone is off, the LED indicator will light red.
- To switch to **Bluetooth Pairing** state, press and hold the **(Mic On/Off)** button on the WiFi Speaker for more than 3 seconds.

LED indicator

The LED indicator flashes, glows, or changes color depending on the WiFi Speaker's current mode or status.

Rear

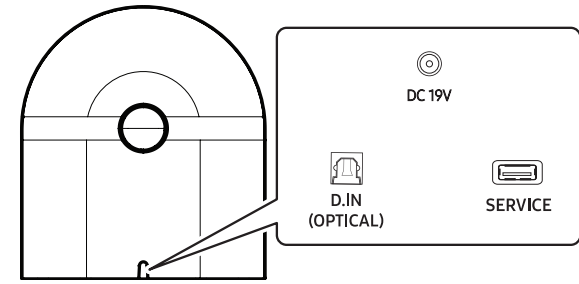

SERVICE

Use this port to update firmware.

DC 19V

Connect the power cable to this power port.

D. IN(OPTICAL)

Connect to a digital (optical) output terminal of an external device.

03 Connecting the Power

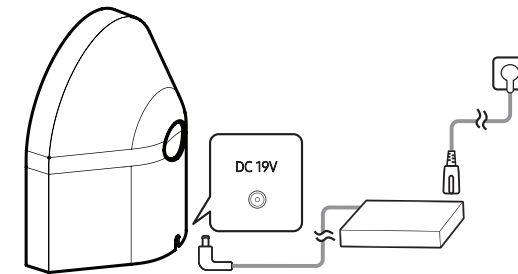

For more information about the required electrical power and power consumption, refer to the label attached to the product. (Label: Bottom of the WiFi Speaker)

04 Connecting to the Samsung Sound app

1 Installation

- The Samsung Sound app allows you to control the functionality of and adjust the settings of the WiFi Speaker.
- Download the Samsung Sound app from your mobile device's app store (App Store, Play Store) or scan the provided QR code.



2 Device registration

- Run the Samsung Sound app on your mobile device.
 - Follow the on screen instructions and add the product to your mobile device.
- If the automatic pop-up window does not appear, press (+) on the Home screen to register the product.

NOTE

- By scanning the QR code attached to the WiFi Speaker, you can directly register the WiFi Speaker to the Samsung Sound app.

3 Control with Samsung Sound

- Open the Samsung Sound app on your mobile device, and then select the WiFi Speaker you have registered.
 - The settings menu of the WiFi Speaker appears, where you can adjust the various settings including **Volume**, **Sound Mode** or **Equalizer**.
- If another user wants to control the WiFi Speaker,
 - Make sure the mobile device is connected to the same Wi-Fi network as the WiFi Speaker.
 - Open the Samsung Sound app and follow the on-screen instructions to complete the setup. Once the setup is finished, the WiFi Speaker can be controlled through the app.

05 Connecting by Wi-Fi with TV

Change the input source of the TV by using the Audio menu to WiFi Speaker.

- Samsung TVs released in 2017 or later: Home (🏠) → Settings (⚙) → All Settings (⚙) → Sound → Sound Output → Music Studio 5 (Wi-Fi)

NOTE

- Wi-Fi connection is available only on Samsung TV.
- The TV and WiFi Speaker must be connected to the same wireless network (Wi-Fi).
- The menus may differ depending on the year of manufacture, refer to your TV manual.

06 Using the Q-Symphony Function

- This function is supported only when both the WiFi Speaker and the TV are connected to the same Wi-Fi network.
- It is available with Samsung TV models released in 2022 or later.

When the WiFi Speaker connects to a Samsung TV that supports the Q-Symphony function, you can play the sound simultaneously through the WiFi Speaker and the TV. If you use the Q-Symphony function, the surround sound played on the WiFi Speaker allows you to enjoy a richer, more three-dimensional surround sound effect.

- Turn on both the TV and the WiFi Speaker.
- Select the WiFi Speaker you want to connect in the TV's Q-Symphony settings. (Home (🏠) → Settings (⚙) → All Settings (⚙) → Sound → Q-Symphony Setting)
 - When the WiFi Speaker is connected, Q-Symphony appears in the TV's Sound Output list. To switch back to the TV speaker, select TV Speaker from the list. (Home (🏠) → Settings (⚙) → All Settings (⚙) → Sound → Sound Output)

07 Connecting by Bluetooth with Mobile

- Press **(Mic On/Off)** button for 3 seconds for pairing.
- Search for the Bluetooth device on your mobile device.
 - TV can be connected in the same way.

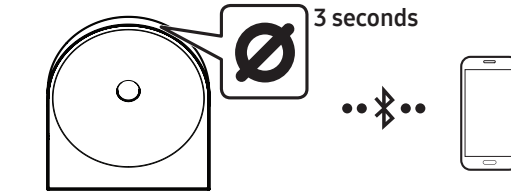

08 Specifications and Information

Model Name	HW-LS50H / HW-LS51H
Weight	5.3 lbs (2.4 kg)
Dimensions (W x H x D)	9.9 x 11.2 x 5.4 inches (251.0 x 283.5 x 137.0 mm)

Operating Temperature Range
 + 50 °F to +104 °F (+10 °C to +40 °C)

Operating Humidity Range
 10 % to 80 %, non-condensing

Storage Temperature Range
 -4 °F to +113 °F (-20 °C to +45 °C)

Storage Humidity Range
 5 % to 95 %, non-condensing

Supported play formats

Dolby 5.1ch / Dolby Digital Plus / Dolby ATMOS (Dolby Digital Plus) / LPCM 2ch

To activate/deactivate Wi-Fi connection

Press and hold the **(Mic On/Off)** button and the - button simultaneously for more than 30 seconds. This will turn on or off the Wi-Fi connection.

To activate/deactivate Bluetooth connection

Press and hold the **(Mic On/Off)** button and the + button simultaneously for more than 30 seconds. This will turn on or off the Bluetooth connection.

Precaution: The WiFi Speaker will restart automatically if you turn on/turn off Wi-Fi or Bluetooth.

NOTE

- Samsung Electronics Co., Ltd reserves the right to change the specifications without notice.
- Weight and dimensions are approximate.

FCC NOTE (for U.S.A.):

FCC Supplier's Declaration of Conformity
Responsible Party - U.S. Contact Information:
 Samsung Electronics America, Inc.
 700 Sylvan Avenue,
 Englewood Cliffs, NJ 07632
 Phone: 1-800-SAMSUNG (726-7864)

FCC Compliance Statement :

This device complies with Part 15 of the FCC Rules.

Operation is subject to the following two conditions:

- (1) This device may not cause harmful interference, and
- (2) this device must accept any interference received, including interference that may cause undesired operation.

FCC Caution :

- Any changes or modifications not expressly approved by the party responsible for compliance could void the user's authority to operate this equipment.
- This product satisfies FCC regulations when shielded cables and connectors are used to connect the unit to other equipment. To prevent electromagnetic interference with electric appliances, such as radios and televisions, use shielded cables and connectors for connections.

Class B FCC Statement

This equipment has been tested and found to comply with the limits for a Class B digital device, pursuant to Part 15 of the FCC Rules. These limits are designed to provide reasonable protection against harmful interference in a residential installation. This equipment generates, uses and can radiate radio frequency energy and, if not installed and used in accordance with the instructions, may cause harmful interference to radio communications. However, there is no guarantee that interference will not occur in a particular installation. If this equipment does cause harmful interference to radio or television reception, which can be determined by turning the equipment off and on, the user is encouraged to try to correct the interference by one of the following measures:

- Reorienting or relocating the receiving antenna.
- Increasing the separation between the equipment and receiver.
- Connecting the equipment to an outlet that is on a different circuit than the radio or TV.
- Consulting the dealer or an experienced radio/TV technician for help.

FCC Radiation Exposure Statement :

This equipment complies with FCC radiation exposure limits set forth for an uncontrolled environment. This equipment should be installed and operated so there is at least 8 inches (20 cm) between the radiator and your body. This device and its antenna(s) must not be co-located or operated in conjunction with any other antenna or transmitter.

CALIFORNIA USA ONLY (Applicable for networking models only.)

This Perchlorate warning applies only to primary CR(Manganese Dioxide) Lithium coin cells in the product sold or distributed ONLY in California USA "Perchlorate Material - special handling may apply, See www.dtsc.ca.gov/hazardouswaste/perchlorate."

⚠️ WARNING: Cancer and Reproductive Harm - www.P65Warnings.ca.gov.

Samsung products and recycling

- Dispose unwanted electronics through an approved recycler. To find the nearest recycling location, go to our website: www.samsung.com/recycling Or call, 1-800-SAMSUNG
- **WARNING!** Never dispose of batteries in a fire because they may explode. Do not disassemble, crush, puncture, heat, burn or reuse batteries.

For more information, visit [call2recycle.org](tel:1-800-822-8837) or call 1-800-822-8837. Alternatively, visit: www.samsung.com/recycling or call 1-800-SAMSUNG.

09 Troubleshooting

Refer to the instructions below if this product does not function properly. If the problem you are experiencing is not listed below or if the instructions below do not help, turn off the product, disconnect the power cord, and contact Samsung Electronics at 1-800-SAMSUNG (1-800-726-7864).

WiFi Speaker does not turn on.

- Check whether the power cord of the WiFi Speaker is correctly inserted into the outlet.

WiFi Speaker works erratically.

- After removing the power cord, insert it again.
- Try again after initializing the product.
- If there is no signal, the WiFi Speaker automatically turns off after a certain period of time. Turn on the power.

The red LED indicator light on the WiFi Speaker stays on.

- The microphone is turned off. The LED indicator turns off when the microphone is turned on.

Sound is not output from the WiFi Speaker.

- The volume of the WiFi Speaker is too low or muted. Adjust the volume.
- When any external device (Set-Top Box, Bluetooth device, mobile device, etc.) is connected, adjust the volume of the external device.
- For sound output of the TV, select WiFi Speaker. (Samsung TV: Home (🏠) → Settings (⚙️) → All Settings (⚙️) → Sound → Sound Output → Select Music Studio 5)
- Remove the cable from the WiFi Speaker and then reconnect it.

WiFi Speaker will not connect by Bluetooth.

- When connecting a new device, switch to "BT PAIRING" for connection. (Press the **⏻ (Mic On/Off)** button on the body for at least 3 seconds.)
- Reconnect it after removing the Bluetooth speaker list on the device to connect. (Samsung TV: Home (🏠) → Settings (⚙️) → All Settings (⚙️) → Sound → Sound Output → Bluetooth Speaker List)

Sound drops out when connected by Bluetooth.

- Some devices can cause radio interference if they are located too close to the WiFi Speaker. e. g. microwaves, wireless routers, etc.
- If your device that is connected by Bluetooth moves too far away from the WiFi Speaker, it may cause the sound to drop out. Move the device closer to the WiFi Speaker.
- If a part of your body is in contact with the Bluetooth transceiver or the product is installed on metal furniture, the sound may drop out. Check the installation environment and conditions for use.

WiFi Speaker will not connect to Wi-Fi.

- Make sure the wireless router is turned on and then reconnect the wireless router after rebooting.
- The WiFi Speaker will not connect if the wireless signal is too weak. Try moving the router closer to the WiFi Speaker, or eliminating any obstacles that are between the WiFi Speaker and the router, if possible.

The WiFi Speaker does not turn on automatically with the TV.









- When you turn off the WiFi Speaker while watching TV, power synchronization with the TV is disabled. First turn off the TV.

Safety Information

SAFETY WARNINGS

TO REDUCE THE RISK OF ELECTRIC SHOCK, DO NOT REMOVE THE COVER (OR BACK). NO USER-SERVICEABLE PARTS ARE INSIDE. REFER SERVICING TO QUALIFIED SERVICE PERSONNEL.

Refer to the table below for an explanation of symbols which may be on your Samsung product.

	CAUTION RISK OF ELECTRIC SHOCK. DO NOT OPEN	
	This symbol indicates that high voltage is present inside. It is dangerous to make any kind of contact with any internal part of this product.	
	This symbol indicates that this product has included important literature concerning operation and maintenance.	
	Class II product : This symbol indicates that a safety connection to electrical earth (ground) is not required. If this symbol is not present on a product with a power cord, the product MUST have a reliable connection to protective earth (ground).	
	AC voltage : Rated voltage marked with this symbol is AC voltage.	
	DC voltage : Rated voltage marked with this symbol is DC voltage.	
	Caution. Consult Instructions for use : This symbol instructs the user to consult the user manual for further safety related information.	

WARNING

- To reduce the risk of fire or electric shock, do not expose this appliance to rain or moisture.

- To prevent injury, this apparatus must be securely attached to the floor/wall in accordance with the installation instructions.
- This product contains chemicals known to the State of California to cause cancer and birth defects or other reproductive harm.
- Do not use liquid fumigators containing chemicals, such as mosquito repellent or air freshener, around the product. If steam comes in contact with the product surface or enters the product, it may cause stains or malfunction.
- For crevices or other areas that cannot be thoroughly cleaned with a cloth, use a soft cotton swab, brush, or air blower to remove dirt.

CAUTION

- Do not expose this apparatus to dripping or splashing. Do not put objects filled with liquids, such as vases, on the apparatus.
- To turn this apparatus off completely, you must pull the power plug out of the wall socket. Consequently, the power plug must be easily and readily accessible at all times.

Important Safety Instructions

Read these operating instructions carefully before using the unit. Follow all the safety instructions listed below. Keep these operating instructions handy for future reference.

1. Read these instructions.
2. Keep these Instructions.
3. Heed all warnings.
4. Follow all instructions.
5. Do not use this apparatus near water.
6. Clean only with dry cloth.
7. Do not block any ventilation openings. Install in accordance with the manufacturer's instructions.
8. Do not install near any heat sources such as radiators, heat registers, stoves, or other apparatus (including amplifiers) that produce heat.

9. Do not defeat the safety purpose of the polarized or grounding-type plug. A polarized plug has two blades with one wider than the other. A grounding type plug has two blades and a third grounding prong. The wide blade or the third prong are provided for your safety. If the provided plug does not fit into your outlet, consult an electrician for replacement of the obsolete outlet.
10. Protect the power cord from being walked on or pinched particularly at plugs, convenience receptacles, and the point where they exit from the apparatus.
11. Only use attachments/accessories specified by the manufacturer.
12. Use only with the cart, stand, tripod, bracket, or table specified by the manufacturer, or sold with the apparatus. When a cart is used, use caution when moving the cart/apparatus combination to avoid injury from tip-over.
13. Unplug this apparatus during lightning storms or when unused for long periods of time.
14. Refer all servicing to qualified service personnel. Servicing is required when the apparatus has been damaged in any way, such as power-supply cord or plug is damaged, liquid has been spilled or objects have fallen into the apparatus, the apparatus has been exposed to rain or moisture, does not operate normally, or has been dropped.



PRECAUTIONS

1. Ensure that the AC power supply in your house complies with the power requirements listed on the identification sticker located on the bottom of your product. Install your product horizontally, on a suitable base (furniture), with enough space around it for ventilation (3-4 inches). Make sure the ventilation slots are not covered. Do not place the unit on amplifiers or other equipment which may become hot. This unit is designed for continuous use. To fully turn off the unit, disconnect the AC plug from the wall outlet. Unplug the unit if you intend to leave it unused for a long period of time.
2. During thunderstorms, disconnect the AC plug from the wall outlet. Voltage peaks due to lightning could damage the unit.
3. Do not expose the unit to direct sunlight or other heat sources. This could lead to overheating and cause the unit to malfunction.
4. Protect the product from moisture (i.e. vases), and excess heat (e.g. a fireplace) or equipment creating strong magnetic or electric fields. Unplug the power cable from the AC wall socket if the unit malfunctions. Your product is not intended for industrial use. It is for personal use only. Condensation may occur if your product has been stored in cold temperatures. If transporting the unit during the winter, wait approximately 2 hours until the unit has reached room temperature before using.
5. Make sure to rest the AC/DC Adapter flat on a table or the floor. If you place the AC/DC Adapter so that it is hanging with the AC cord input facing upwards, water or other foreign substances could enter the Adapter and cause the Adapter to malfunction.

LIMITED WARRANTY TO ORIGINAL CONSUMER PURCHASER WITH PROOF OF PURCHASE AND/OR PROOF OF DELIVERY

This SAMSUNG brand product, as supplied and distributed by SAMSUNG and delivered new, in the original carton to the original consumer purchaser, is warranted by SAMSUNG against manufacturing defects in materials and workmanship for a limited warranty period of:

One (1) Year Parts and Labor*
(*90 Days Parts and Labor for Commercial Use)

This limited warranty begins on the date of delivery to the original consumer purchaser, and is valid only on products purchased and used in the United States. To receive warranty service, the purchaser must contact SAMSUNG for problem determination and service procedures. Warranty service can only be performed by a SAMSUNG authorized service center. The original dated bill of sale and/or proof of delivery must be presented upon request to SAMSUNG or SAMSUNG's authorized service center. Transportation of the product to and from the service center is the responsibility of the purchaser. SAMSUNG will repair or replace this product, at our option and at no charge as stipulated herein, with new or reconditioned parts or products if found to be defective during the limited warranty period specified above. All replaced parts and products become the property of SAMSUNG and must be returned to SAMSUNG. Replacement parts and products assume the remaining original warranty, or ninety (90) days, whichever is longer. SAMSUNG's obligations with respect to software products distributed by SAMSUNG under the SAMSUNG brand name are set forth in the applicable end user license agreement. Non-SAMSUNG hardware and software products, if provided, are on an "AS IS" basis.

Non-SAMSUNG manufacturers, suppliers, publishers, and service providers may provide their own warranties. This limited warranty covers manufacturing defects in materials and workmanship encountered in normal, and except to the extent otherwise expressly provided for in this statement, noncommercial use of this product, and shall not apply to the following, including, but not limited to: damage which occurs in shipment, delivery and installation; applications and uses for which this product was not intended; altered product or serial numbers; cosmetic damage or exterior finish; accidents, abuse, neglect, fire, water, lightning or other acts of nature; use of products, equipment, systems, utilities, services, parts, supplies, accessories, applications, installations, repairs, external wiring or connectors not supplied and authorized by SAMSUNG, or which damage this product or result in service problems; incorrect electrical line voltage, fluctuations and surges; customer adjustments and failure to follow operating instructions, cleaning, maintenance and environmental instructions that are covered and prescribed in the instruction book; product removal or reinstallation; reception problems and distortion related to noise, echo, interference or other signal transmission and delivery problems. SAMSUNG does not warrant uninterrupted or error-free operation of the product.

Some states do not allow limitations on how long an implied warranty lasts, or the exclusion or limitation of incidental or consequential damages, so the above limitations or exclusions may not apply to you. This warranty gives you specific legal rights, and you may also have other rights which vary from state to state. To obtain warranty service, please contact SAMSUNG customer care center. The benefits of this Limited Warranty extend only to the original purchaser of Samsung products from an authorized Samsung reseller. THIS LIMITED WARRANTY SHALL NOT APPLY TO ANY SAMSUNG PRODUCTS PURCHASED FROM UNAUTHORIZED RESELLERS OR RETAILERS, EXCEPT IN STATES WHERE SUCH RESTRICTION MAY BE PROHIBITED. For a list of Samsung authorized retailers, please go to: http://www.samsung.com/us/peaceofmind/authorized_resellers.html.

THERE ARE NO EXPRESS WARRANTIES OTHER THAN THOSE LISTED AND DESCRIBED ABOVE, AND NO WARRANTIES WHETHER EXPRESS OR IMPLIED, INCLUDING, BUT NOT LIMITED TO, ANY IMPLIED WARRANTIES OF MERCHANTABILITY OR FITNESS FOR A PARTICULAR PURPOSE, SHALL APPLY AFTER THE EXPRESS WARRANTY PERIODS STATED ABOVE, AND NO OTHER EXPRESS WARRANTY OR GUARANTY GIVEN BY ANY PERSON, FIRM OR CORPORATION WITH RESPECT TO THIS PRODUCT SHALL BE BINDING ON SAMSUNG. SAMSUNG SHALL NOT BE LIABLE FOR LOSS OF REVENUE OR PROFITS, FAILURE TO REALIZE SAVINGS OR OTHER BENEFITS, OR ANY OTHER SPECIAL, INCIDENTAL OR CONSEQUENTIAL DAMAGES CAUSED BY THE USE, MISUSE OR INABILITY TO USE THIS PRODUCT, REGARDLESS OF THE LEGAL THEORY ON WHICH THE CLAIM IS BASED, AND EVEN IF SAMSUNG HAS BEEN ADVISED OF THE POSSIBILITY OF SUCH DAMAGES. NOR SHALL RECOVERY OF ANY KIND AGAINST SAMSUNG BE GREATER IN AMOUNT THAN THE PURCHASE PRICE OF THE PRODUCT SOLD BY SAMSUNG AND CAUSING THE ALLEGED DAMAGE. WITHOUT LIMITING THE FOREGOING, PURCHASER ASSUMES ALL RISK AND LIABILITY FOR LOSS, DAMAGE OR INJURY TO PURCHASER AND PURCHASER'S PROPERTY AND TO OTHERS AND THEIR PROPERTY ARISING OUT OF THE USE, MISUSE OR INABILITY TO USE THIS PRODUCT SOLD BY SAMSUNG NOT CAUSED DIRECTLY BY THE NEGLIGENCE OF SAMSUNG. THIS LIMITED WARRANTY SHALL NOT EXTEND TO ANYONE OTHER THAN THE ORIGINAL PURCHASER OF THIS PRODUCT, IS NONTRANSFERABLE AND STATES YOUR EXCLUSIVE REMEDY.

Some states do not allow limitations on how long an implied warranty lasts, or the exclusion or limitation of incidental or consequential damages, so the above limitations or exclusions may not apply to you. This warranty gives you specific legal rights, and you may also have other rights which vary from state to state. To obtain warranty service, please contact SAMSUNG customer care center. The benefits of this Limited Warranty extend only to the original purchaser of Samsung products from an authorized Samsung reseller. THIS LIMITED WARRANTY SHALL NOT APPLY TO ANY SAMSUNG PRODUCTS PURCHASED FROM UNAUTHORIZED RESELLERS OR RETAILERS, EXCEPT IN STATES WHERE SUCH RESTRICTION MAY BE PROHIBITED. For a list of Samsung authorized retailers, please go to: http://www.samsung.com/us/peaceofmind/authorized_resellers.html.