

Knickerbocker™

B E D A R C H I T E C T U R E



(emBrace)™ 360
WrapAround Bed Support System

(emBrace)™
Designed and Engineered for Today's Sleep Sets

ENGAUGE™
BED SUPPORT SYSTEM

The emBrace™ 360 WrapAround™ is a **versatile** mattress support system.

The emBrace WrapAround™ 360 is a designer support system crafted with the finest materials and workmanship. Contoured feet and side rails with tapered legs establish the emBrace WrapAround™ 360 as the vanguard of bedroom fashion.

Choose your foundation height.

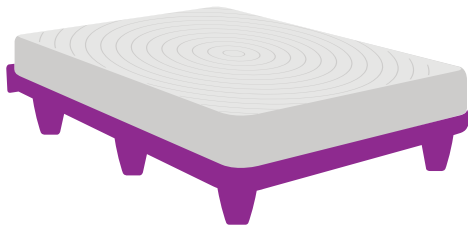

Foam / Latex / Inner Spring

"Bunkie Boards" can be used with a WrapAround omitting the need for a box foundation.

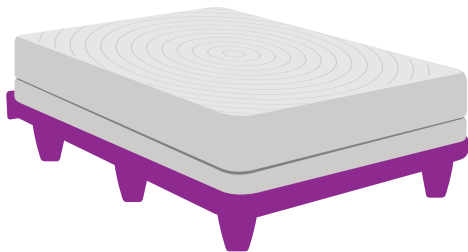

Low Profile Box Spring

Compatible with low profile box foundations, the foot end contours allow for an easy and accurate fit.

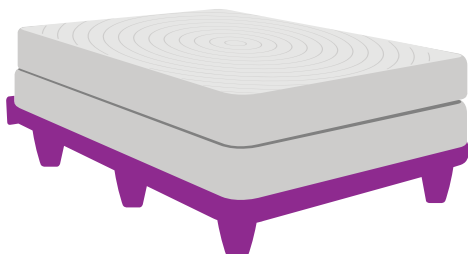

Traditional Box Spring

Compatible with traditional box foundations, the foot end contours allow for an easy and accurate fit.



(emBrace)³⁶⁰
WrapAround Bed Support System

Won't
crack
under
pressure.



(emBrace)³⁶⁰
WrapAround Bed Support System

Traditional bed frames can flex and warp under pressure.

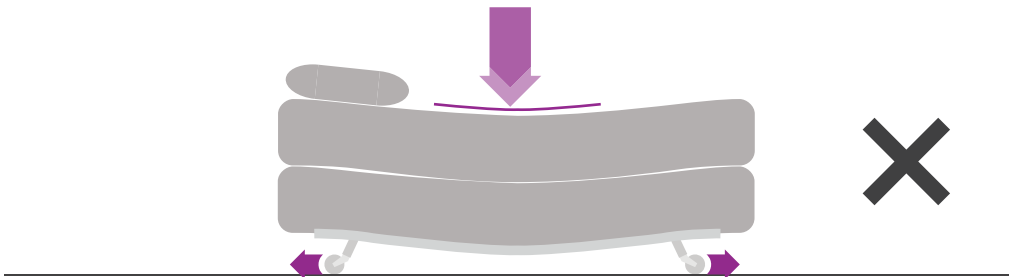

The emBrace WrapAroundTM 360 uses high carbon recycled railroad steel.

The steel cross rails feature T-shape profiles that give the frame a rigid, zero-flex structural advantage.

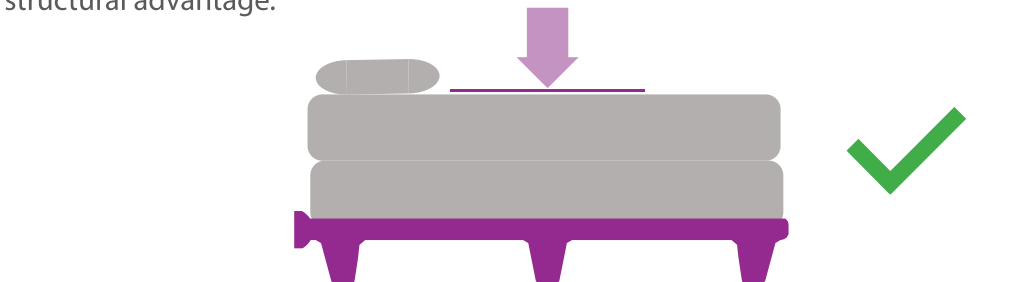

The emBraceTM WrapAroundTM 360 is tested and approved to hold up to 5,000 pounds!



Upgrade your mattress
and get better sleep
with proper support.

Proper support will **improve the feel** of your mattress and **extend the life** of your sleep set. Your mattress was designed to be at its best seated on a **high quality support system**.

Working a double.

Fully supported double beams at the foot end of the bed prevents tipping. The inner corners are rounded allowing a foundation to fit seamlessly.

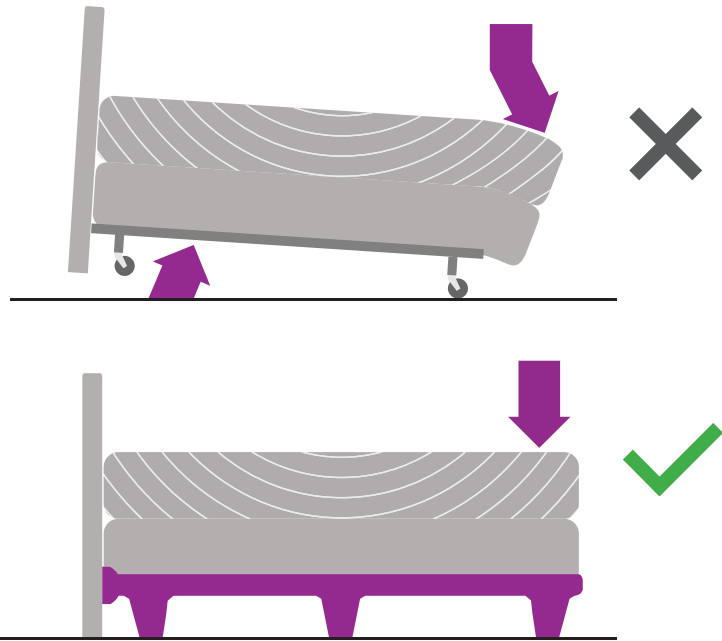

The patented T steel design of the emBrace™ WrapAround™ 360 is vertical in side rails, providing rock solid support in all sizes. This system produces incredible strength that will not flex.

Double Foot Rail Supports

(emBrace)TM 360
WrapAround Bed Support System

Steeling the show.

From the outside, the emBrace WrapAround 360 system is injection molded, featuring resin parts that are fiberglass infused. With no exposed metal, it is warm to the touch, hygienic and easy to clean.

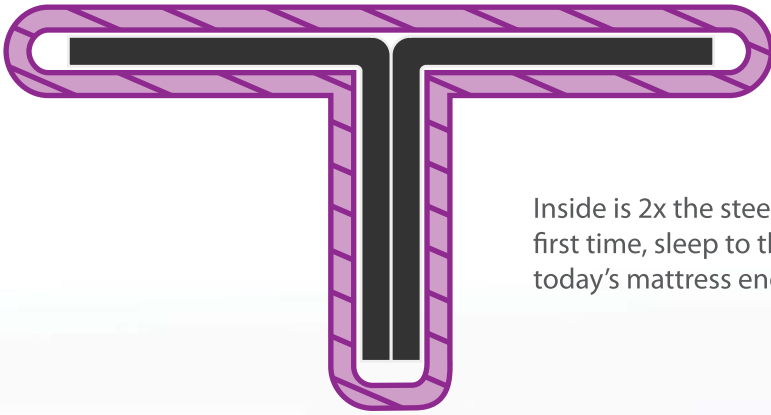

Inside is 2x the steel of traditional bed frames. For the first time, sleep to the edge support is matched with today's mattress engineering.

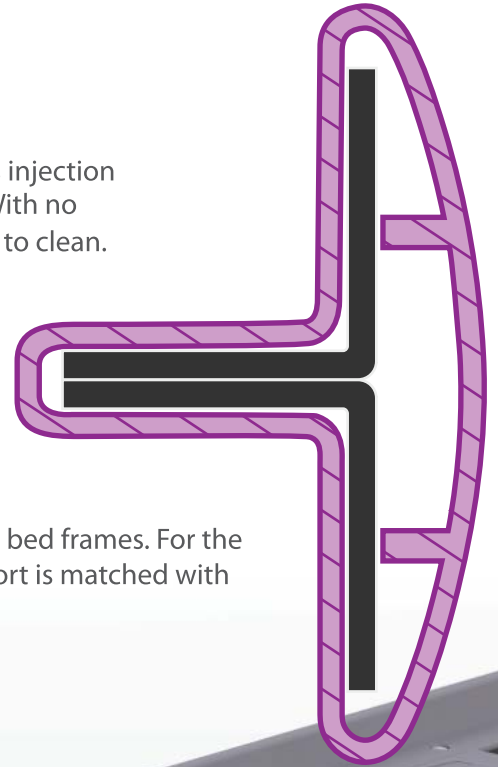

Steel Side Rail Support

Double Foot Rail Supports

Frustration not included.



Tool Free.
Gravity feed assembly.

Goes together in seconds!

Leave the assembly to the **experts.**

Parts come pre-assembled leaving more time and less headache

(emBrace)³⁶⁰
WrapAround Bed Support System



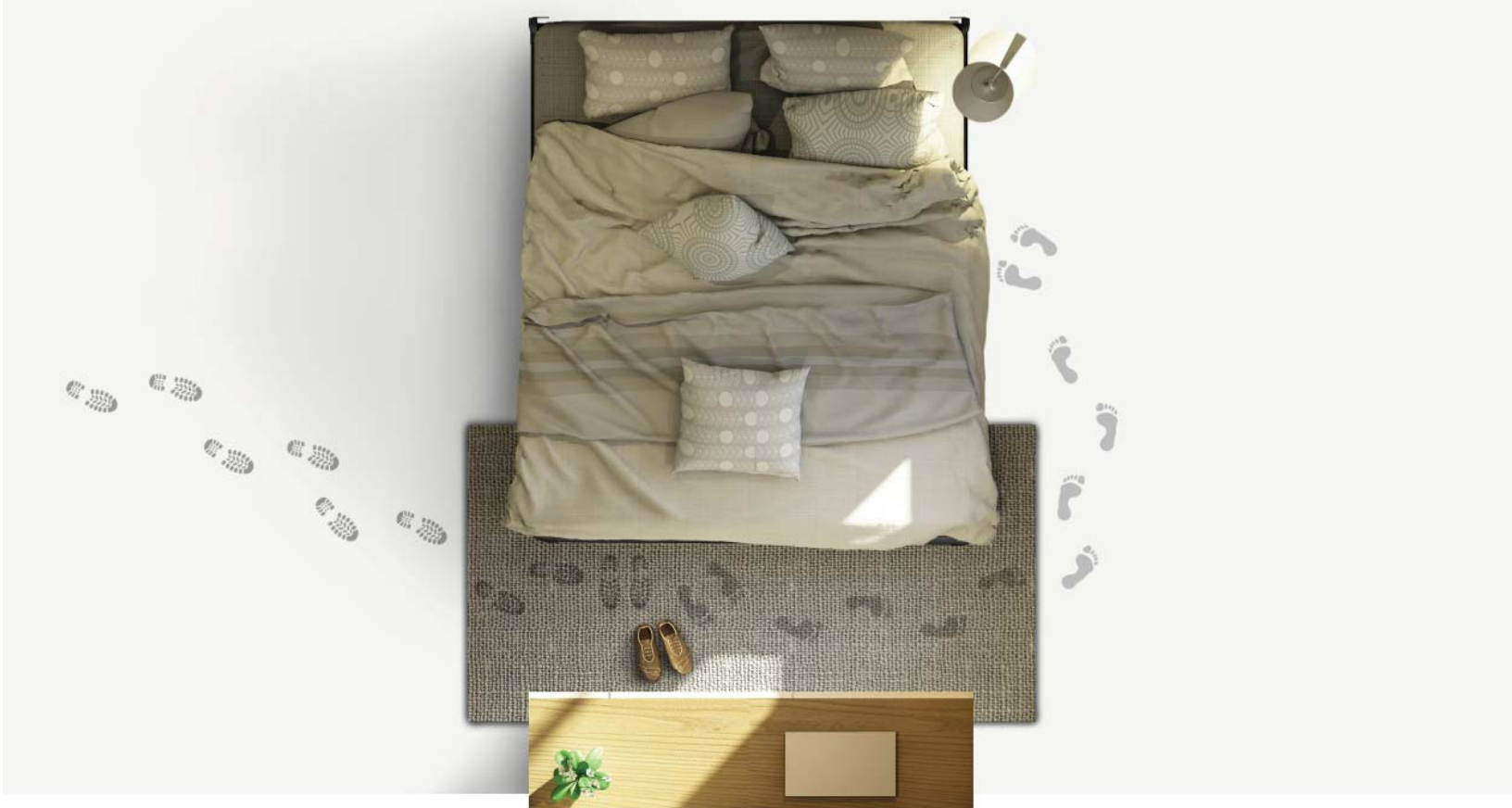

Any headboard.
Endless options.

No footboard means more access.

Without a footboard, you will find more access to the bed and better navigation within the space.





Baby proof.

Smooth contours create a baby safe product. Inset legs and soft edges alleviate stubbed toes and provide an enlarged walking space.

MADE WITH PRIDE



IN THE USA

(emBrace)³⁶⁰ WrapAround Bed Support System

Knickerbocker
BED ARCHITECTURE

12.6.2017

The emBrace Wraparound is patented with additional patents pending.

Twin Size

- 4139-1 white
- 4139-2 black
- 4139-3 brown
- 4139-4 gray



4 Support Legs-
Legs 7 1/2" standard height

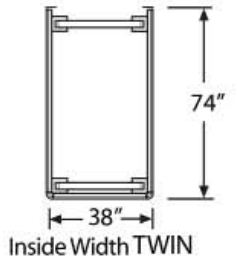

Full Size

- 4154-1 white
- 4154-2 black
- 4154-3 brown
- 4154-4 gray



6 Support Legs-
Legs 7 1/2" standard height

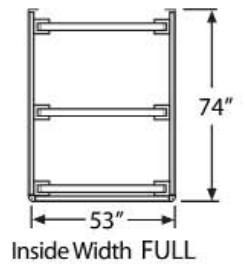

Queen Size

- 4160-1 white
- 4160-2 black
- 4160-3 brown
- 4160-4 gray



7 Support Legs-
Legs 7 1/2" standard height

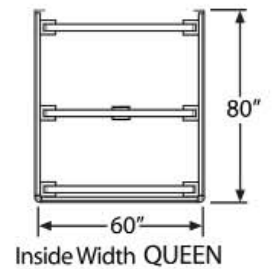

King Size

- 4176-1 white
- 4176-2 black
- 4176-3 brown
- 4176-4 gray



9 Support Legs-
Legs 7 1/2" standard height

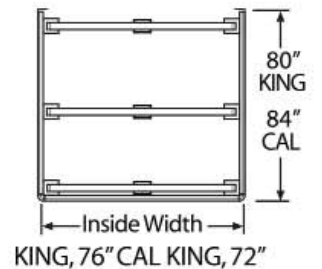

Cal King Size

- 4172-1 white
- 4172-2 black
- 4172-3 brown
- 4172-4 gray

Available in:

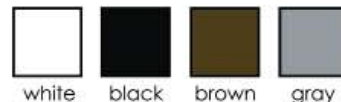

All (emBrace) Support Systems offer a Lifetime Limited Warranty

Knickerbocker Advanced Bed Support Systems, Carlstadt, NJ, USA 1 800- 526-6294

Advanced, high performance support systems that offer the *ultimate* in form and function.

(emBrace™)

Designed and Engineered for Today's Sleep Sets

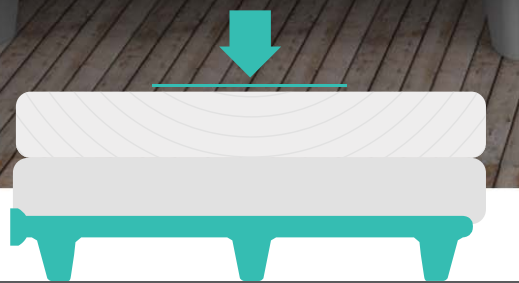

emBrace™ Bed Support System

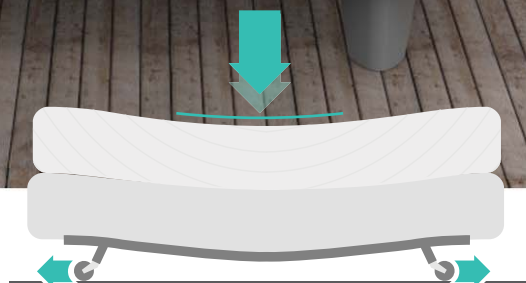

Traditional bedframe

Won't
cave
under
pressure.

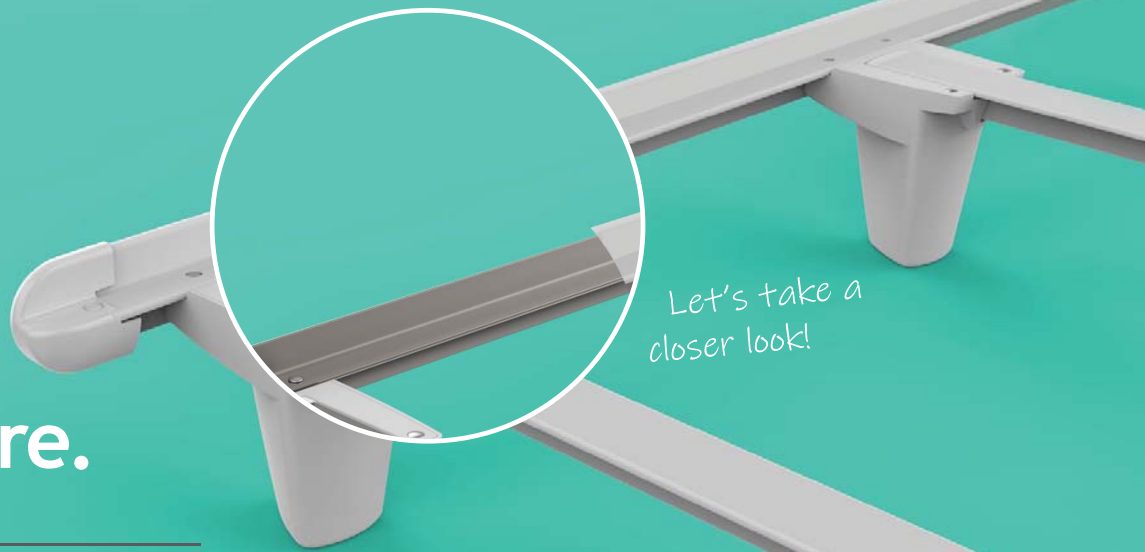

The emBrace™ Bed Support System uses high carbon recycled steel.

Both the steel cross + side rails feature T-shape profiles that give the frame a rigid, zero-flex structural advantage.

Traditional bed frames can flex and warp under pressure.



Available in:



White



Black



Brown



Grey

Advanced, high performance
support systems that offer the
ultimate in form and function.

Designed and engineered to meet the demands of today's luxury bedding.

No Motion Transfer,
Flex Free Support

emBrace™ guarantees a correct assembly **every time.**

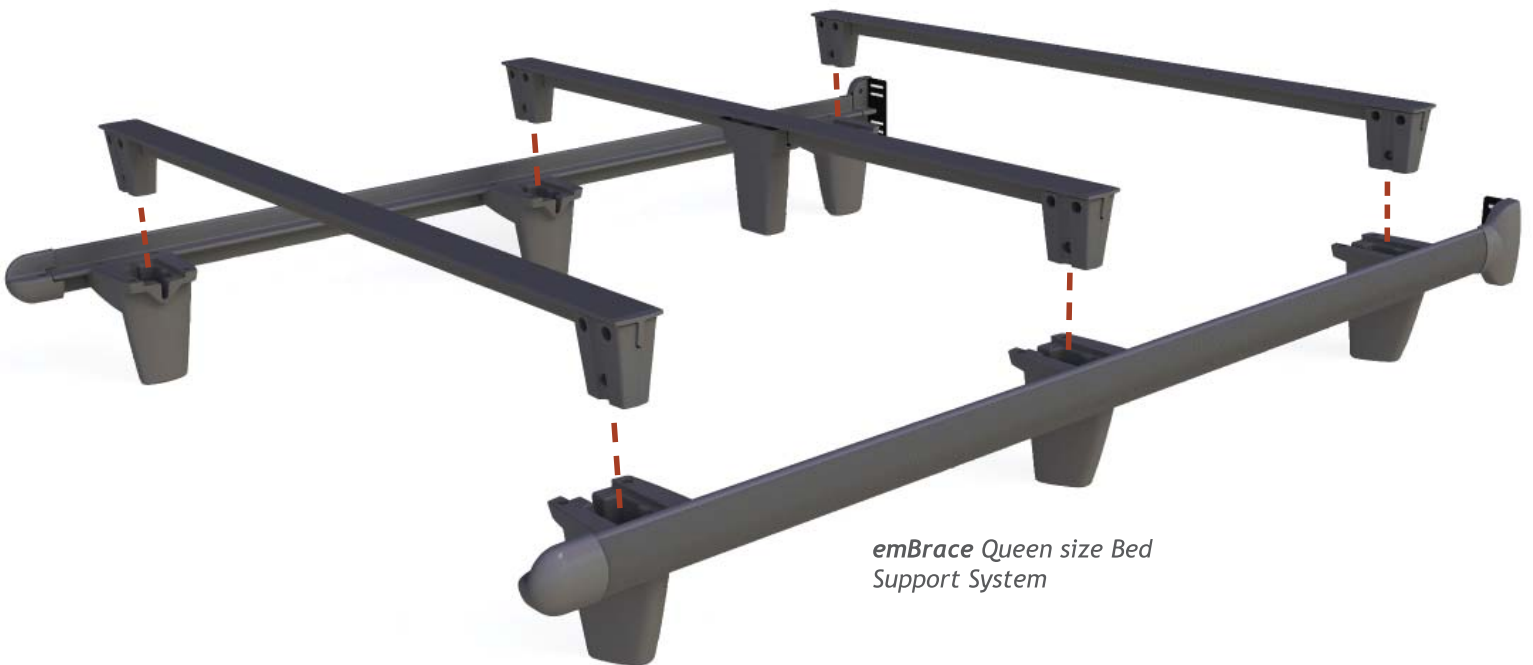

(emBrace™)

Designed and Engineered for Today's Sleep Sets

Twin

- 2139 - 1 white
- 2139 - 2 black
- 2139 - 3 brown
- 2139 - 4 grey

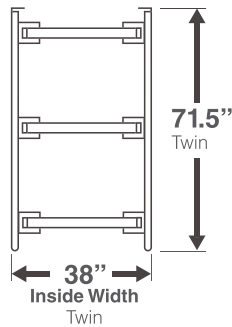

4 support legs
legs 7.5" standard height

Full

- 2154 - 1 white
- 2154 - 2 black
- 2154 - 3 brown
- 2154 - 4 grey

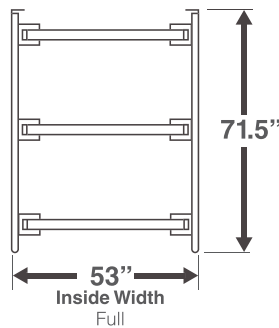

6 support legs
legs 7.5" standard height

Queen

- 2160 - 1 white
- 2160 - 2 black
- 2160 - 3 brown
- 2160 - 4 grey

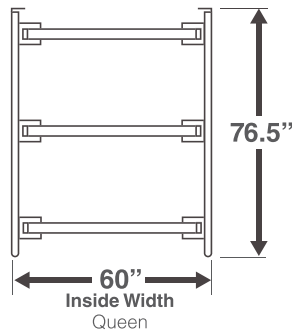

7 support legs
6 perimeter + 1 center
legs 7.5" standard height

King

- 2176 - 1 white
- 2176 - 2 black
- 2176 - 3 brown
- 2176 - 4 grey

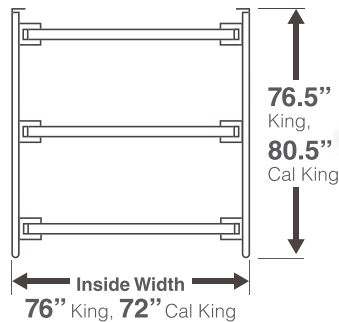

9 support legs
6 perimeter + 3 center
legs 7.5" standard height

Cal King

- 2172 - 1 white
- 2172 - 2 black
- 2172 - 3 brown
- 2172 - 4 grey

Backed by

KNICKERBOCKER'S LIMITED LIFETIME WARRANTY



Deluxe enGauge Hybrid: NEW!

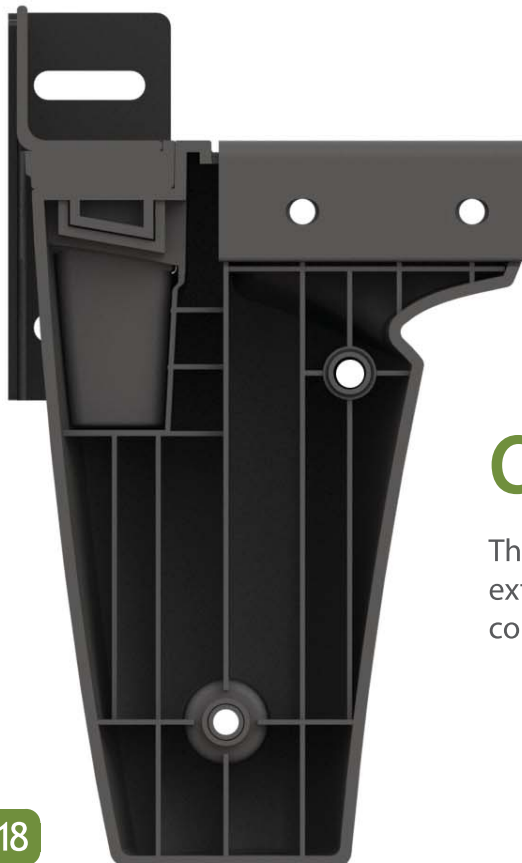

Composite Technology

The interior of the new enGauge Bed Support System is reinforced for extra strength and durability. This molded system allows for smooth comfortable contours that will compliment any bedroom decor.



ENGAUGETM
BED SUPPORT SYSTEM

Mattress Support from
a whole new angle





Standard enGauge Hybrid

Assembles in less than a minute **without using any tools!**





guarantees a correct assembly every time.



Deluxe enGauge system shown in King size uses just 5 components.



Standard enGauge system shown in King size uses just 5 components.

MADE WITH PRIDE



IN THE USA



Knickerbocker
BED ARCHITECTURE

Twin Size

SKU #1139



4 Support Legs-
Legs 8" standard height

71 1/2" long
2" High Side Rails
Double Steel Cross Rails

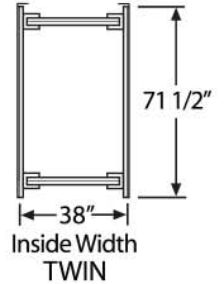

Full Size

SKU #3154



7 Support Legs-
Legs 8" standard height

71 1/2" long
2" High Side Rails
Double Steel Cross Rails

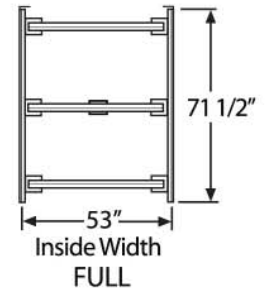

Queen Size

SKU #3160



7 Support Legs-
Legs 8" standard height

74" long
2" High Side Rails
Double Steel Cross Rails

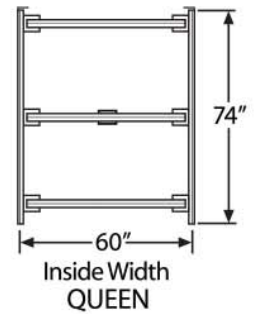

King Size

SKU #3176



9 Support Legs-
Legs 8" standard height

74" long
2" High Side Rails
Double Steel Cross Rails

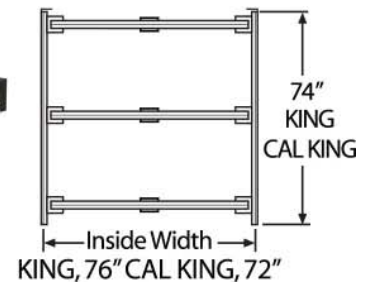

Cal King Size

SKU #3172

All  Support Systems offer a Lifetime Limited Warranty



MADE WITH PRIDE



IN THE USA



Knickerbocker
BED ARCHITECTURE

Twin Size

SKU #1139-2



4 Support Legs-
Legs 8" standard height

71 1/2" long
2" High Side Rail

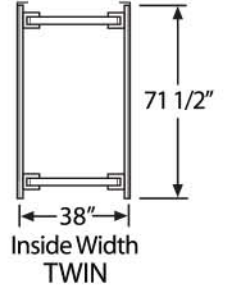

Full Size

SKU #1154-2



6 Support Legs-
Legs 8" standard height

74" long
2" High Side Rail

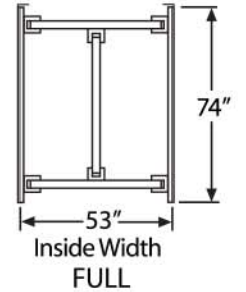

Queen Size

SKU #1160-2



6 Support Legs-
Legs 8" standard height

74" long
2" High Side Rail

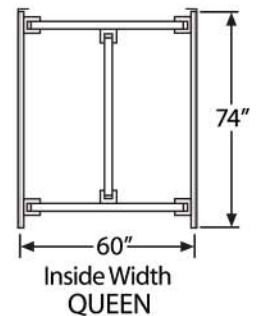

King Size

SKU #1176-2



6 Support Legs-
Legs 8" standard height

74" long
2" High Side Rail

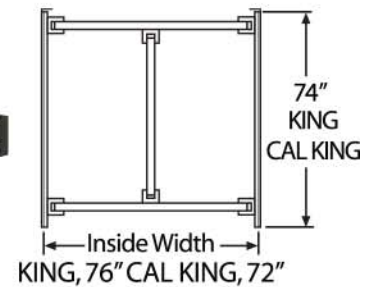

Cal King Size

SKU #1172-2

6 Support Legs-
Legs 8" standard height

74" long
2" High Side Rail

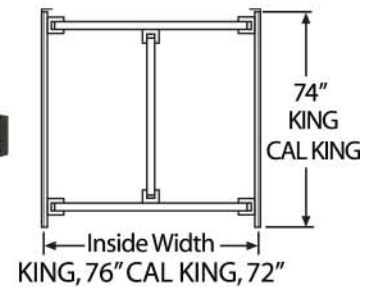

All  Support Systems offer a Lifetime Limited Warranty



Knickerbocker Advanced Bed Support Systems, Carlstadt, NJ, USA 1 800- 526-6294

TRADITIONAL UNDER -THE-BED SUPPORT SYSTEMS

#KB2007G

Ultra Premium 7 Leg Bed Frame



2" SIDE RAILS!

Also available as a **KB2007LPG**, Low Profile frame with a 3 inch reduced overall height.

#6078G

Premium 6 Leg Bed Frame



All Knickerbocker Products are **Made with Pride in the USA**



TRADITIONAL UNDER -THE-BED SUPPORT SYSTEMS

#4650G

Deluxe 6 Leg Bed Frame



#38G

Bed Frame



All Knickerbocker Products are **Made with Pride in the USA**



(emBrace)TM

Designed and Engineered for Today's Sleep Sets



emBrace tabletop point of sale display



enGauge tabletop point of sale display

Bedbeam™

Replacement Bed-Slat Support System

*Deluxe Queen and King size
Bedbeam Configuration
on a wood bed*



Drop & Lock™
Technology
locks legs in place.

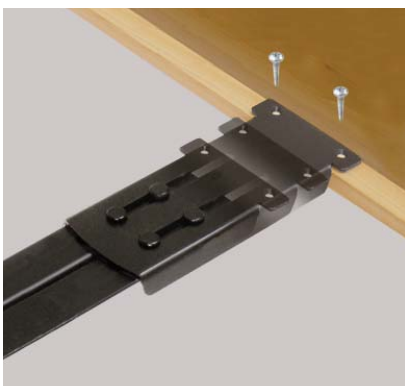

Wide attachment
ends secure to
wood side rail cleat.

Drop & Lock technology makes
installation fast.

Width adjustment accommodates
most wood bed frames.

Deluxe Bedbeam Systems

F543.... Full size K783..... King size
Q633... Queen size CK723... Cal King size

Bedbeam™

Replacement Bed-Slat Support System

The Problem Wood Slats



The Solution Bedbeam



The ONLY Solution that really works



Bedbeam Support System



Deluxe Bedbeam System shown with 3 leg beams plus height adjustment tubes.

Bedbeam™ II

Replacement Bed-Slat Support System



*Bedbeam II
Twin steel
beams*

SKUs

Full.....BB2-46

Queen.....BB2-50

King.....BB2-66

Cal King....BB2-72

MADE WITH PRIDE



IN THE USA



Width and height adjustments
to fit most wood beds.

Knickerbocker
BED ARCHITECTURE



When attached to the side rails, the Bedbeam II™ Support beams hold the center support leg rigidly in place and provide unyielding support, even when the bed is moved sideways.



Wide attachment ends secure to wood side rail cleat.



Drop & Lock™ Technology locks legs in place.

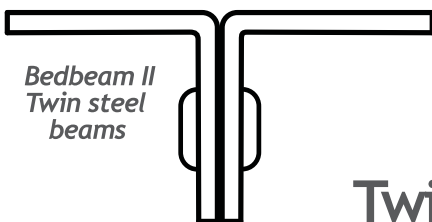

Bedbeam II
Twin steel
beams

Twin steel beams for **engineered** strength.

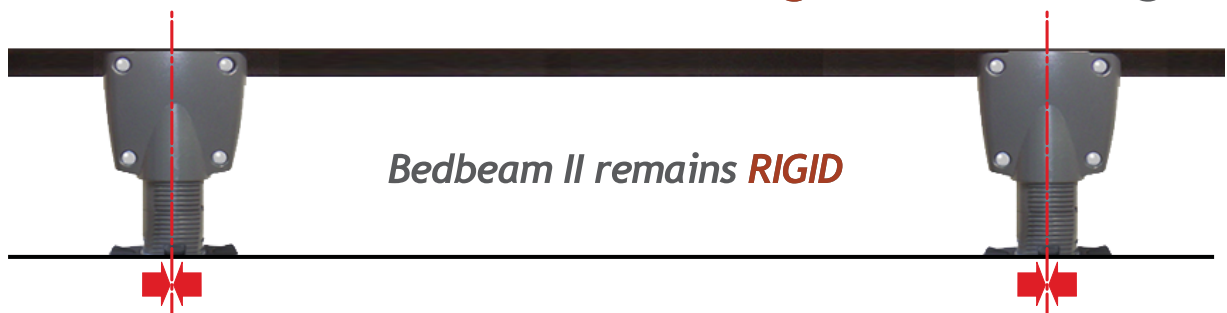

Bedbeam II remains **RIGID**

Lazarbeam™

Replacement Bed-Slat Support System



Lazarbeam Support System on a wood bed

SKU
#LBH-456
(adjustable:
F,Q,K,CK)



Width and spin down height adjustments fit most wood beds.

MADE WITH PRIDE



Lazarbeam™

Replacement Bed-Slat Support System

The Problem Wood Slats



The Solution Lazarbeam



Lazarbeam Systems

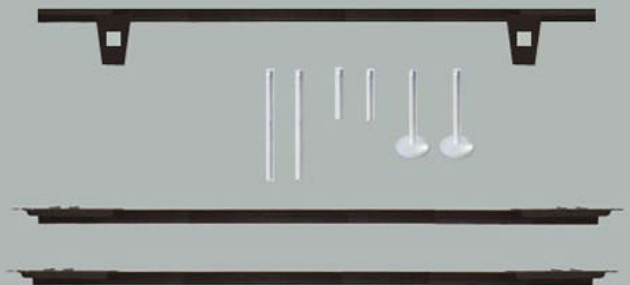

Full Deluxe...FH422

Queen Deluxe...QH522

King Deluxe...KH622

Cal King Deluxe...CKH722

Knickerbocker products source raw materials domestically,



are built with recycled steel & plastic,



are protected with patents,

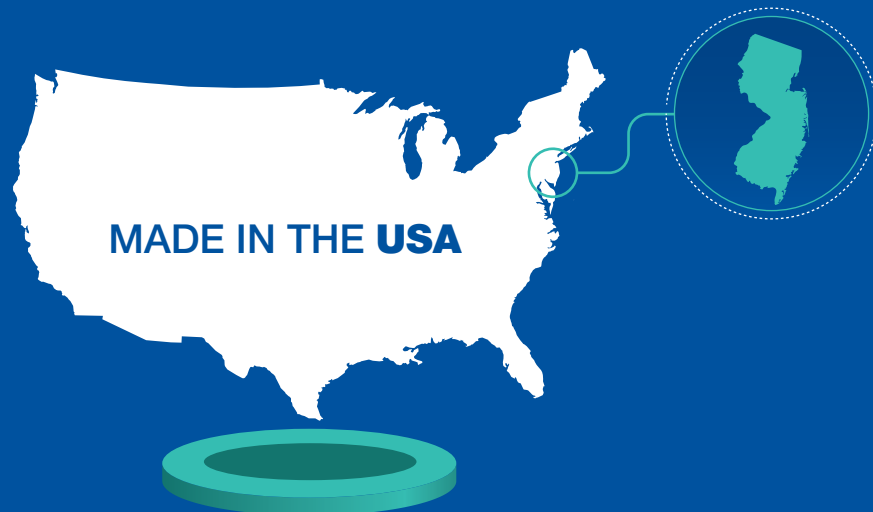

and are 100% designed, manufactured and assembled in the USA.

Knickerbocker
BED ARCHITECTURE

Knickerbocker products are built with **recycled** steel,

Recycled steel processed by clean, domestically produced methane gas, captured from nearby landfills is piped to the mill and used to power the furnaces that convert the rail into angle iron. They make a “dirty” business clean, and they do it right here in America.



that are processed and formed with **Green Energy**,

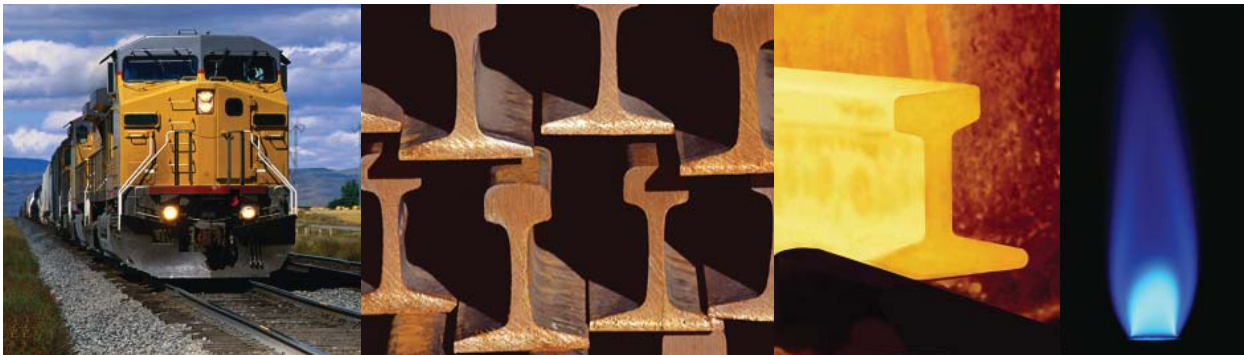

INNOVATION IN MODERN BED SUPPORT



Knickerbocker™
BED ARCHITECTURE

770 Commercial Avenue
Carlstadt, New Jersey, USA 07072
1 800-526-6294

www.knickerbockerbedframe.com

Copyright © 2019 Knickerbocker, All rights reserved

KNICK-2019 Catalog

MADE WITH PRIDE



IN THE USA