



HOSHIZAKI

Service Manual

Modular Crescent Cuber

Models

KM-901MAJ, MWJ, MRJ(Z)/3

KM-1100MAJ, MWJ, MRJ(Z)

KM-1340MAJ, MWJ, MRJ(Z)/3

KM-1601MRJ(Z)/3



hoshizakiamerica.com

Number: 73213
Issued: 1-30-2018
Revised: 9-23-2025

⚠ WARNING

Only qualified service technicians should install and service the appliance. To obtain the name and phone number of your local Hoshizaki Certified Service Representative, visit www.hoshizakiamerica.com. No service should be undertaken until the technician has thoroughly read this Service Manual. Failure to service and maintain the appliance in accordance with this manual will adversely affect safety, performance, component life, and warranty coverage. Proper installation is the responsibility of the installer. Product failure or property damage due to improper installation is not covered under warranty.

Hoshizaki provides this manual primarily to assist qualified service technicians in the service of the appliance.

Should the reader have any questions or concerns which have not been satisfactorily addressed, please call, send an e-mail message, or write to the Hoshizaki Technical Support Department for assistance.

Phone: 1-800-233-1940; (770) 487-2331

E-mail: tech-support@hoshizaki.com

HOSHIZAKI AMERICA, INC.

618 Highway 74 South

Peachtree City, GA 30269

Attn: Hoshizaki Technical Support Department

NOTE: To expedite assistance, all correspondence/communication **MUST** include the following information:

- Model Number _____
- Serial Number _____
- Complete and detailed explanation of the problem.

IMPORTANT

This manual should be read carefully before the appliance is serviced. Read the warnings and guidelines contained in this manual carefully as they provide essential information for the continued safe use, service, and maintenance of the appliance. Retain this manual for any further reference that may be necessary.

CONTENTS

Important Safety Information	6
I. Construction and Water/Refrigeration Circuit Diagram	9
A. Construction	9
1a. Air-Cooled Models (MAJ)	9
1b. Air-Cooled Models (MAJ)	10
2a. Water-Cooled Models (MWJ)	11
2b. Water-Cooled Models (MWJ)	12
3a. Remote Models (MRJ(Z)/3)	13
3b. Remote Models (MRJZ/3)	14
B. Water/Refrigeration Circuit Diagram	15
1a. Air-Cooled Models (MAJ)	15
1b. Air-Cooled Models (MAJ)	16
2a. Water-Cooled Models (MWJ)	17
2b. Water-Cooled Models (MWJ)	18
3a. Remote Models (MRJ(Z)/3)	19
3b. Remote Models (MRJZ/3)	20
II. Sequence of Operation and Service Diagnosis	21
A. Sequence of Operation Flow Chart	21
B. Service Diagnosis	28
C. Freeze Up Detection Cycle (Control Board 2A9678-02)	44
D. Control Board Check	47
E. Bin Control Check and Cleaning	50
1. Thermostatic Bin Control Check	50
2. Mechanical Bin Control Check	51
3. Mechanical Bin Control Cleaning	52
4. Ultrasonic Bin Control Check	53
5. Ultrasonic Bin Control Adjustment	55
F. Float Switch Check and Cleaning	58
1. Float Switch Check	58
2. Float Switch Cleaning	59
G. Thermistor Check	60
H. Control Switch	60
I. Diagnostic Tables	61
J. Freeze-Up Check List	65

III. Controls and Adjustments	68
A. Control Board Layout	69
B. LED Lights and Audible Alarm Safeties	71
C. Settings and Adjustments.....	73
1a. Default Dip Switch Settings.....	73
1b. Default Dip Switch Settings.....	74
2. Harvest Timer (S4 dip switch 1 & 2)	75
3. Pump-Out Timer/Harvest Time During Pump-Out (S4 dip switch 3 & 4)	75
4. Pump-Out Frequency Control (S4 dip switch 5).....	76
5. Harvest Pump Time (Harvest Assist) (S4 dip switch 6)	76
6. Harvest Pump Time (Harvest Assist)/Freeze-Time Correction (S4 dip switch 7) ...	77
a) Harvest Pump Time (Harvest Assist)	77
b) Freeze-Time Correction	77
7. Factory Use (S4 dip switch 8).....	78
8. Freeze Timer (S4 dip switch 9 & 10)	78
9. Pump-Out Pump Motor Selector (S5 dip switch 1)	79
10. Refill Counter (S5 dip switch 2 and 3).....	79
11. Minimum Harvest Time (S5 dip switch 4)	79
a) Control Board 2A9678-01.....	79
b) Control Board 2A9678-02	79
12. Anti-Slush (S5 dip switch 5)	80
IV. Refrigeration Circuit and Component Service Information.....	81
A. Refrigeration Circuit Service Information	81
B. Component Service Information.....	84
C. Water Regulating Valve Adjustment (water-cooled model)	84
V. Maintenance	85
VI. Preparing the Appliance for Periods of Non-Use	86
VII. Disposal.....	88
VIII. Technical Information.....	89
A. Specification and Performance Data Sheets.....	89
1. KM-901MAJ.....	89
2. KM-901MWJ	90
3. KM-901MRJ(Z) with URC-14F(Z)	91
4. KM-901MRJ(Z)3 with URC-14F(Z)	92
5. KM-1100MAJ	93
6. KM-1100MWJ	94
7. KM-1100MRJ(Z) with URC-14F(Z)	95
8. KM-1340MAJ.....	96
9. KM-1340MWJ.....	97
10. KM-1340MRJ(Z) with URC-14F(Z)	98
11. KM-1340MRJ(Z)3 with URC-14F(Z)	99
12. KM-1601MRJ(Z) with URC-22F(Z)	100
13. KM-1601MRJ(Z)3 with URC-22F(Z)	101

B. Wiring Diagrams	102
1. Auxiliary Code: P-2 and Earlier	102
a) KM-901M_J(Z), KM-1100M_J(Z)	102
b) KM-901M_J(Z), KM-1100M_J(Z)	103
c) KM-901MRJ(Z)3.....	104
d) KM-901MRJ(Z)3.....	105
2. Auxiliary Code: N-3 and Earlier.....	106
a) KM-1340M_J(Z) and KM-1601MRJ(Z)	106
b) KM-1340M_J(Z) and KM-1601MRJ(Z)	107
c) KM-1340MRJ(Z)3 and KM-1601MRJ(Z)3	108
d) KM-1340MRJ(Z)3 and KM-1601MRJ(Z)3	109
3. Auxiliary Code: P-3 and Later	110
a) KM-901M_J(Z)	110
b) KM-1100M_J(Z)	111
c) KM-901MRJZ3	112
4. Auxiliary Code: P-0 and Later	113
a) KM-1340M_J(Z) and KM-1601MRJZ	113
b) KM-1340MRJZ3 and KM-1601MRJZ3	114

Important Safety Information

Throughout this manual, notices appear to bring your attention to situations which could result in death, serious injury, damage to the appliance, or damage to property.

⚠ WARNING Indicates a hazardous situation which could result in death or serious injury.

NOTICE Indicates a situation which could result in damage to the appliance or property.

IMPORTANT Indicates important information about the use and care of the appliance.

⚠ WARNING

The appliance should be destined only to the use for which it has been expressly conceived. Any other use should be considered improper and therefore dangerous. The manufacturer cannot be held responsible for injury or damage resulting from improper, incorrect, and unreasonable use. Failure to service and maintain the appliance in accordance with this manual will adversely affect safety, performance, component life, and warranty coverage and may result in costly water damage.

To reduce the risk of death, electric shock, serious injury, or fire, follow basic precautions including the following:

- Only qualified service technicians should install and service this appliance.
- The appliance must be installed in accordance with applicable national, state, and local codes and regulations.
- Electrical connection must be hard-wired and must meet national, state, and local electrical code requirements. Failure to meet these code requirements could result in death, electric shock, serious injury, fire, or severe damage to equipment.
- The icemaker requires an independent power supply of proper capacity. See the nameplate for electrical specifications. Failure to use an independent power supply of proper capacity can result in a tripped breaker, blown fuses, damage to existing wiring, or component failure. This could lead to heat generation or fire.
- **THE ICEMAKER MUST BE GROUNDED.** Failure to properly ground the icemaker could result in death or serious injury.
- Move the control switch to the "OFF" position and turn off the power supply before servicing. Lockout/Tagout to prevent the power supply from being turned back on inadvertently.
- To reduce the risk of electric shock, do not touch the control switch with damp hands.
- Do not make any alterations to the unit. Alterations could result in electric shock, injury, fire, or damage to the unit.
- The appliance is not intended for use by persons (including children) with reduced physical, sensory, or mental capabilities, or lack of experience and knowledge, unless they have been given supervision or instruction concerning use of the appliance by a person responsible for their safety.

⚠ WARNING, continued

- Children should be properly supervised around this appliance.
- Do not climb, stand, or hang on the appliance or allow children or animals to do so. Serious injury could occur or the appliance could be damaged.
- Do not use combustible spray or place volatile or flammable substances near the appliance. They might catch fire.
- Keep the area around the appliance clean. Dirt, dust, or insects in the appliance could cause harm to individuals or damage to the appliance.

Additional Warning for Remote Models

- **THE REMOTE CONDENSER UNIT MUST BE GROUNDED.** The power supply and ground connection to the remote condenser unit are supplied from the icemaker. Failure to properly ground the remote condenser unit could result in death or serious injury.
- Move the icemaker control switch to the "OFF" position and turn off the power supply to the icemaker before servicing the remote condenser unit. Lockout/Tagout to prevent the power supply from being turned back on inadvertently.

NOTICE

- Follow the instructions in this manual carefully to reduce the risk of costly water damage.
- In areas where water damage is a concern, install in a contained area with a floor drain.
- Install the appliance in a location that stays above freezing. Normal operating ambient temperature must be within 45°F to 100°F (7°C to 38°C).
- Do not leave the icemaker on during extended periods of non-use, extended absences, or in sub-freezing temperatures. To properly prepare the icemaker for these occasions, follow the instructions in "VI. Preparing the Appliance for Periods of Non-Use."
- Do not place objects on top of the appliance.
- The dispenser unit/ice storage bin is for ice use only. Do not store anything else in the dispenser unit/ice storage bin.

**Reference for pages 23, 27, and 44-46.

These models and Serial Number Breaks use the control board 2A9678-02 (Freeze-Up Detection) and deviate from the Auxiliary Codes listed:

Model	**Control Board 2A9678-02 Auxiliary Code Break
KM-1340MAJ	P12321E - P12360F
KM-1340MWJ	P10461E - P0480E
KM-1340MRJZ	P11300E - P11359F
KM-1601MRJZ	P20737F - P20776F

I. Construction and Water/Refrigeration Circuit Diagram

A. Construction

1a. Air-Cooled Models (MAJ)

Auxiliary Code: P-2 and Earlier (*KM-901MAJ, KM-1100MAJ*)

Auxiliary Code: N-3 and Earlier (*KM-1340MAJ*)

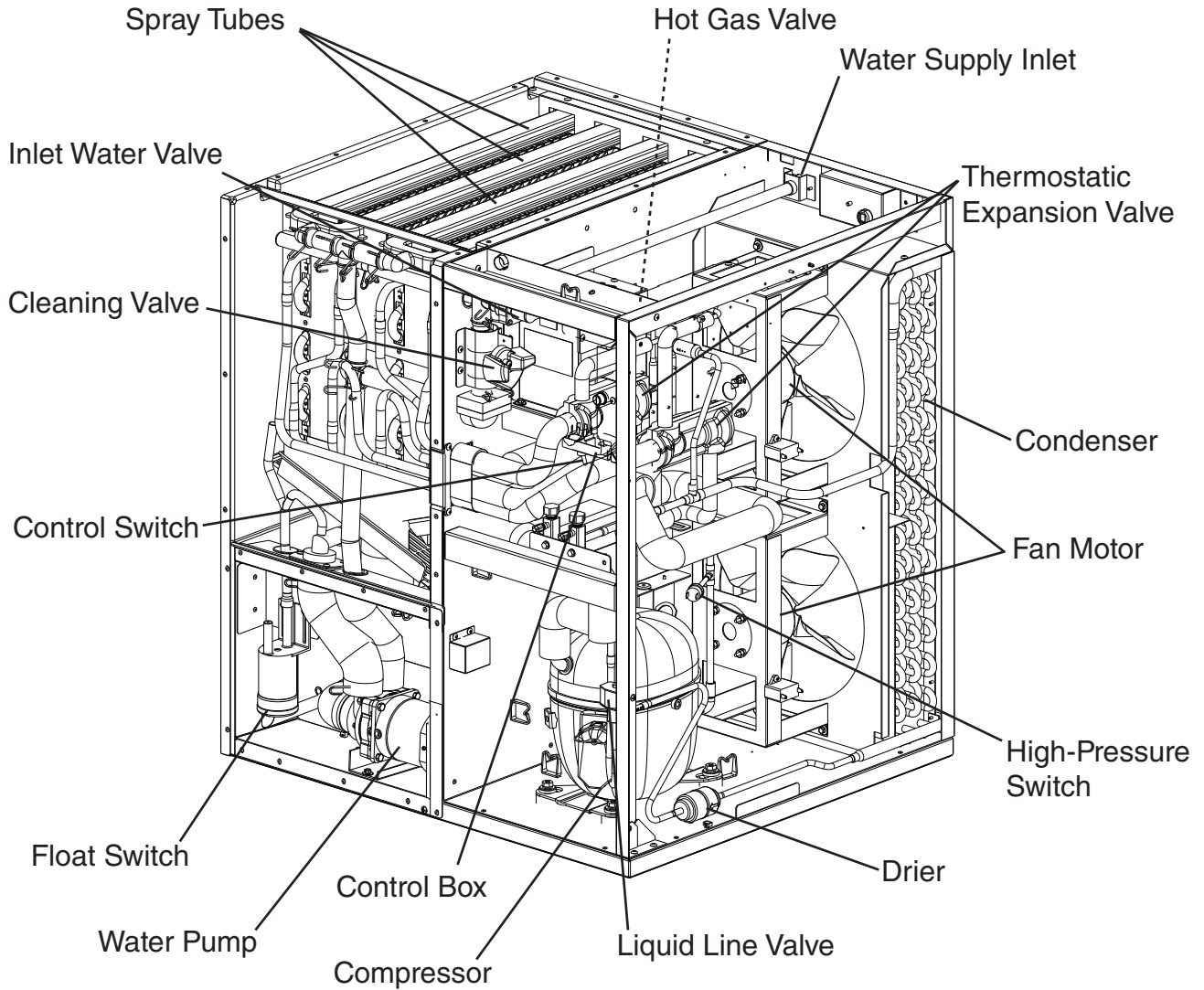

Model Shown: *KM-901MAJ*

1b. Air-Cooled Models (MAJ)

Auxiliary Code: P-3 and Later (KM-901MAJ, KM-1100MAJ)

Auxiliary Code: P-0 and Later (KM-1340MAJ)

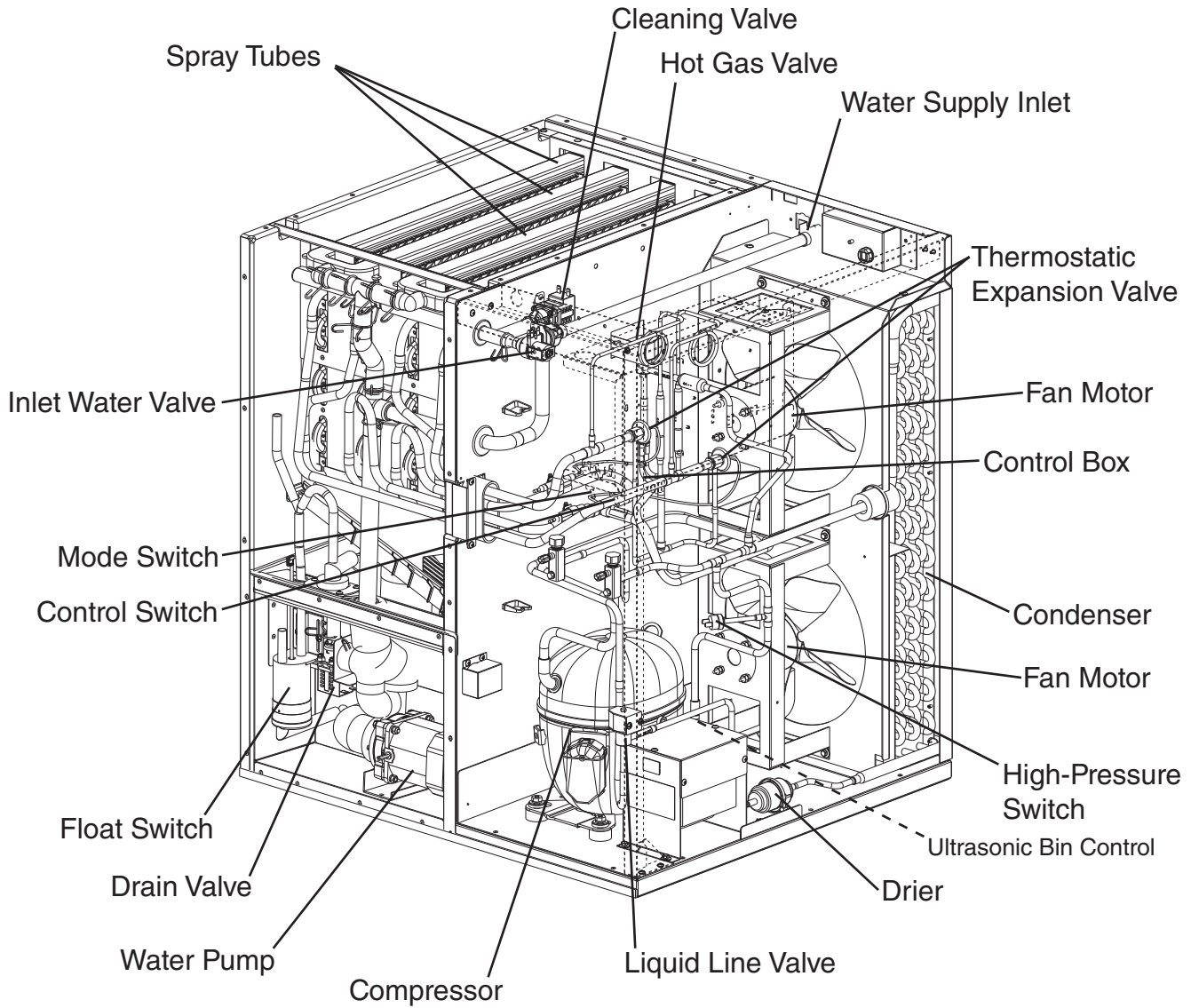

Model Shown: KM-901MAJ

2a. Water-Cooled Models (MWJ)

Auxiliary Code: P-2 and Earlier (KM-901MWJ, KM-1100MWJ)

Auxiliary Code: N-3 and Earlier (KM-1340MWJ)

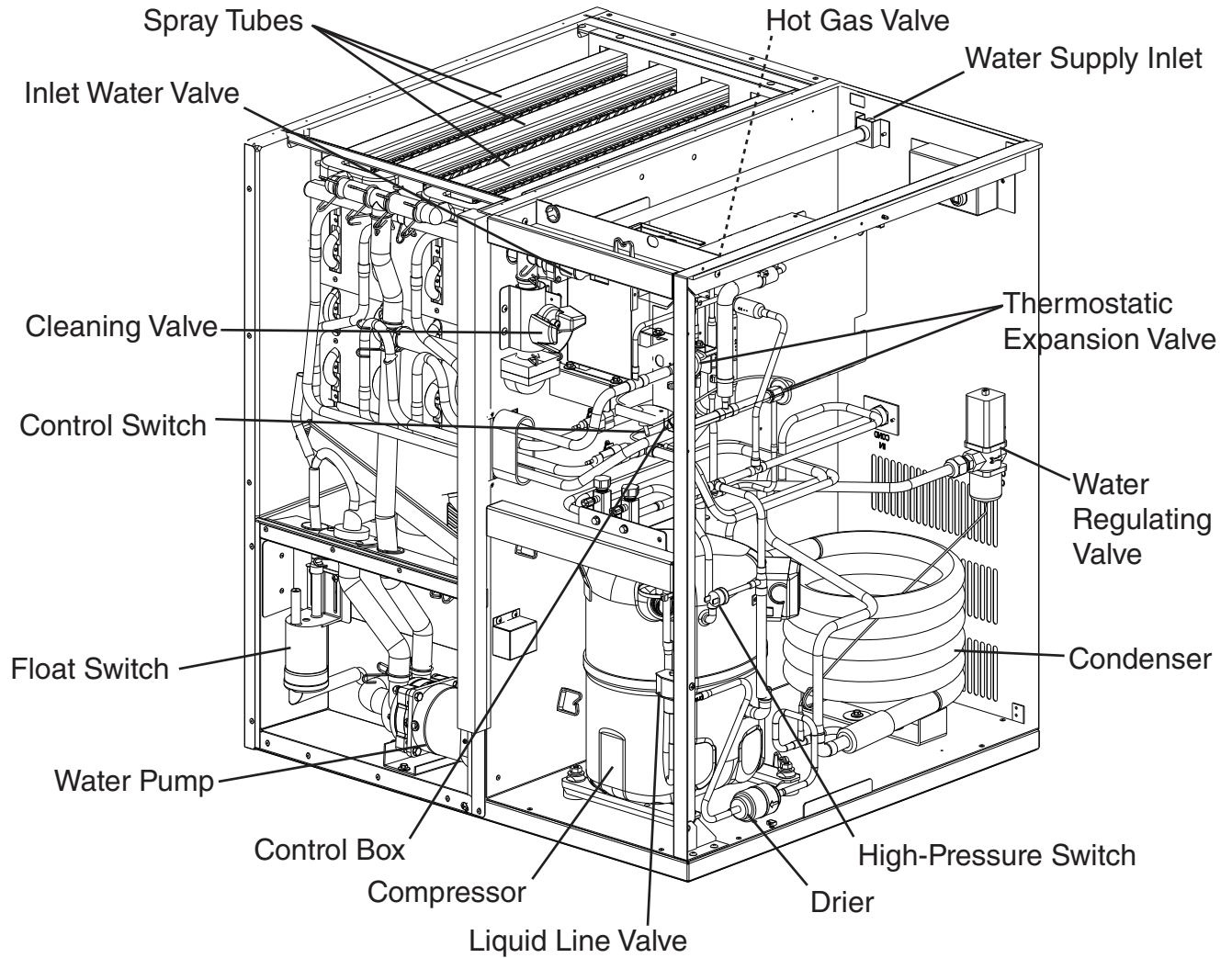

Model Shown: KM-1100MWJ

2b. Water-Cooled Models (MWJ)

Auxiliary Code: P-3 and Later (KM-901MWJ, KM-1100MWJ)

Auxiliary Code: P-0 and Later (KM-1340MWJ)

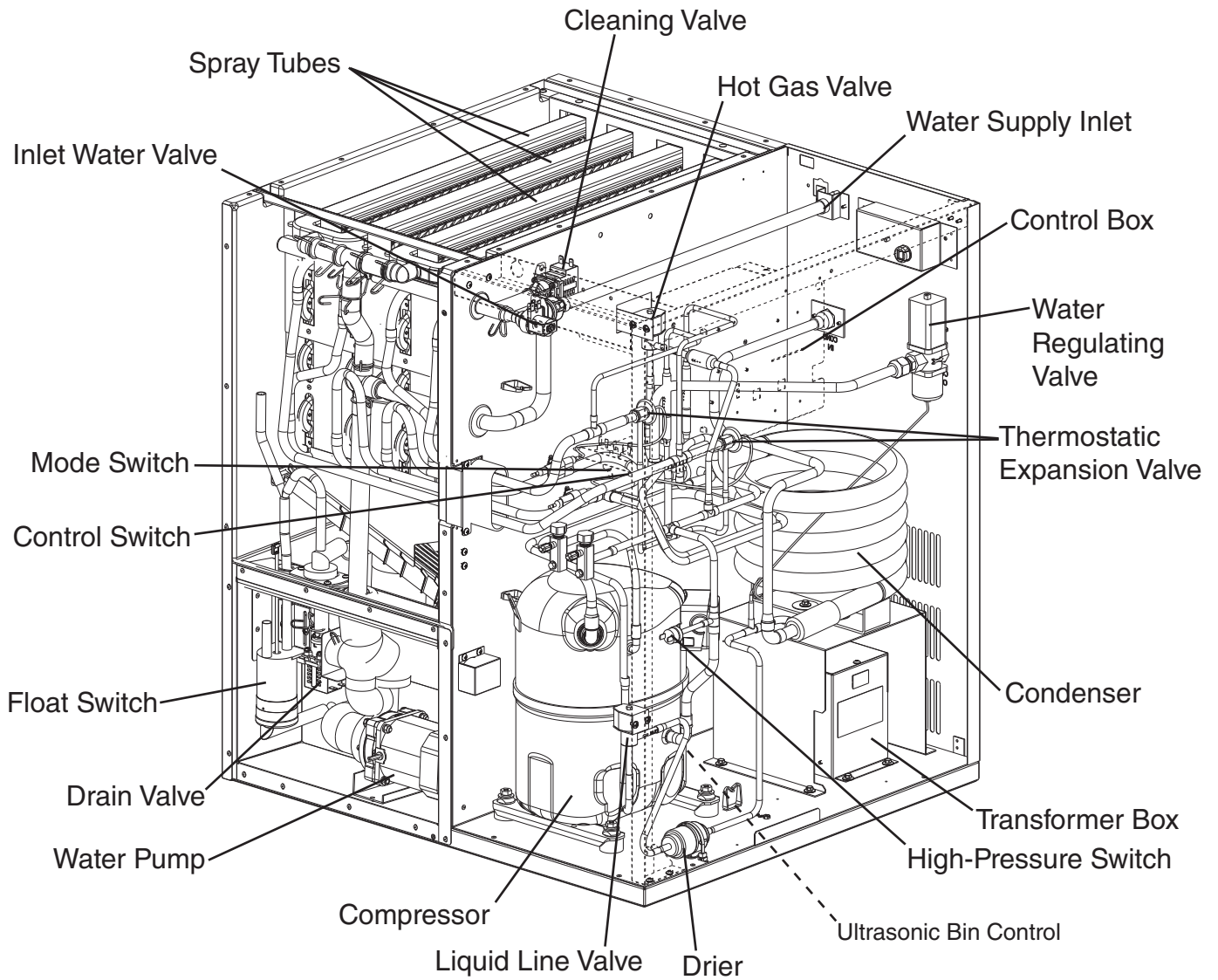

Model Shown: KM-1100MWJ

3a. Remote Models (MRJ(Z)/3)

Auxiliary Code: P-2 and Earlier (KM-901MRJ(Z)/3, KM-1100MRJ(Z))

Auxiliary Code: N-3 and Earlier (KM-1340MRJ(Z)/3, KM-1601MRJ(Z)/3)

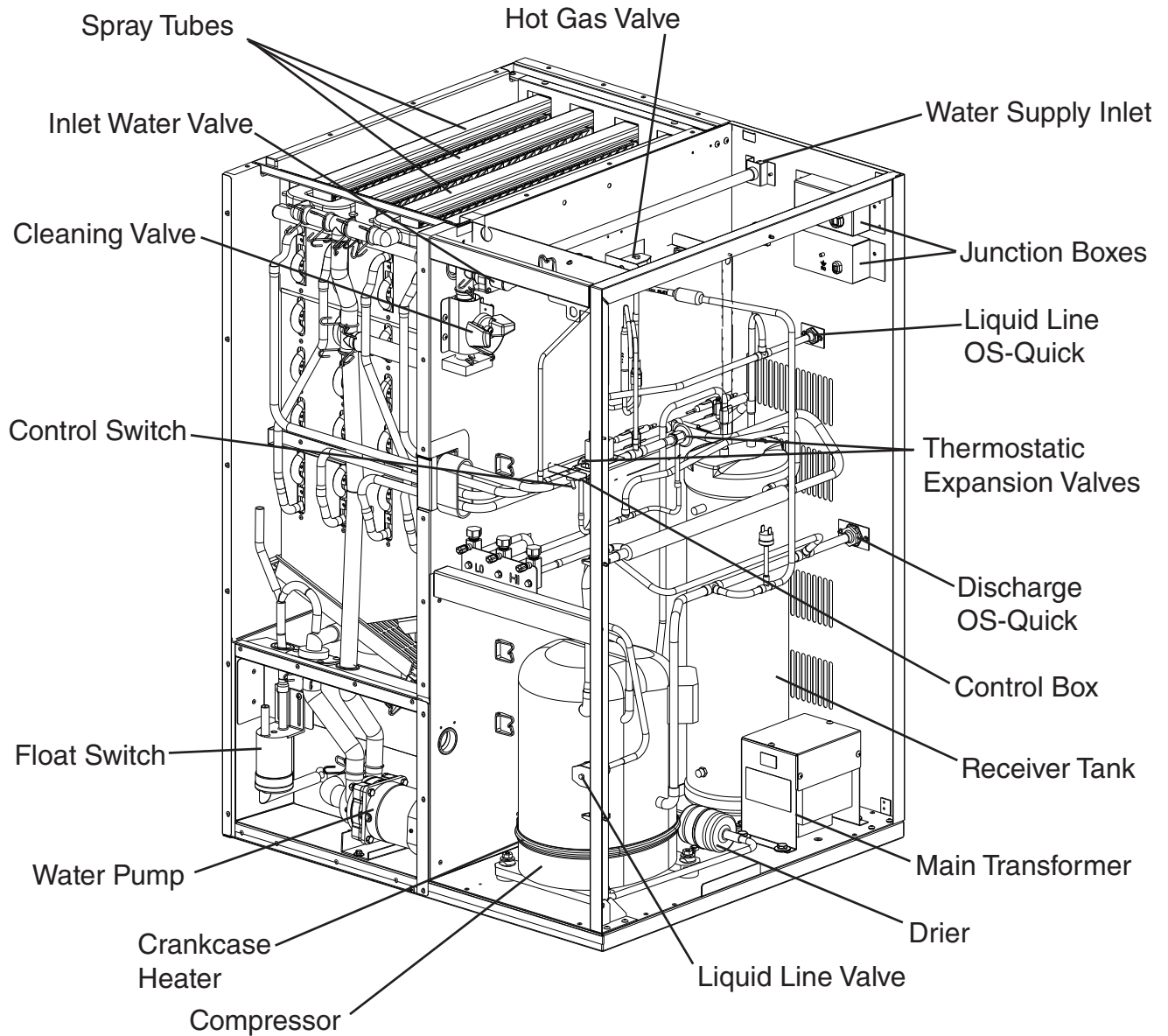

Model Shown: KM-1601MRJ

3b. Remote Models (MRJZ/3)

Auxiliary Code: P-3 and Later (KM-901MRJZ/3, KM-1100MRJZ)

Auxiliary Code: P-0 and Later (KM-1340MRJZ/3, KM-1601MRJZ/3)

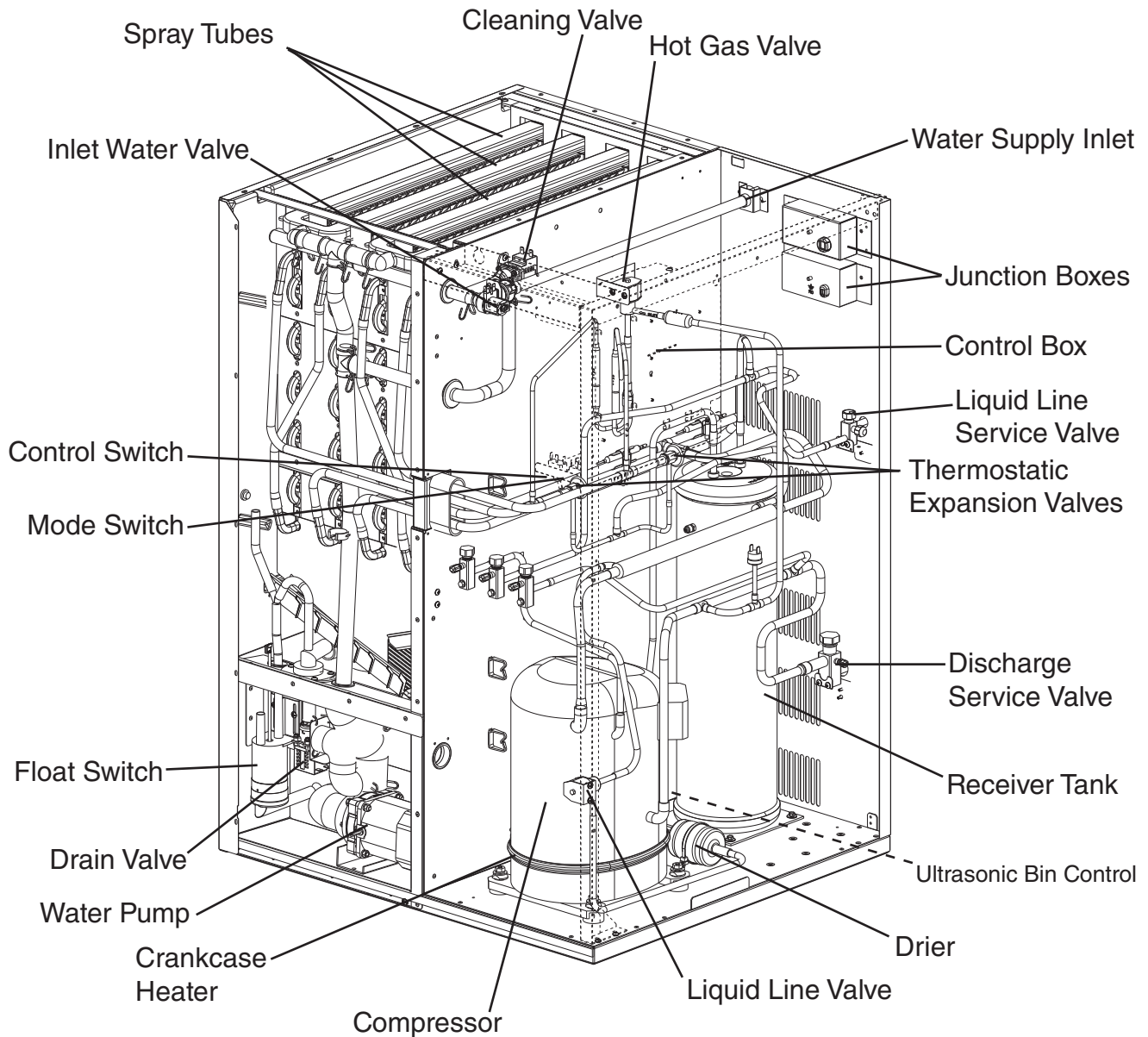

Model Shown: KM-1601MRJZ

B. Water/Refrigeration Circuit Diagram

1a. Air-Cooled Models (MAJ)

Auxiliary Code: P-2 and Earlier (KM-901MAJ, KM-1100MAJ)

Auxiliary Code: N-3 and Earlier (KM-1340MAJ)

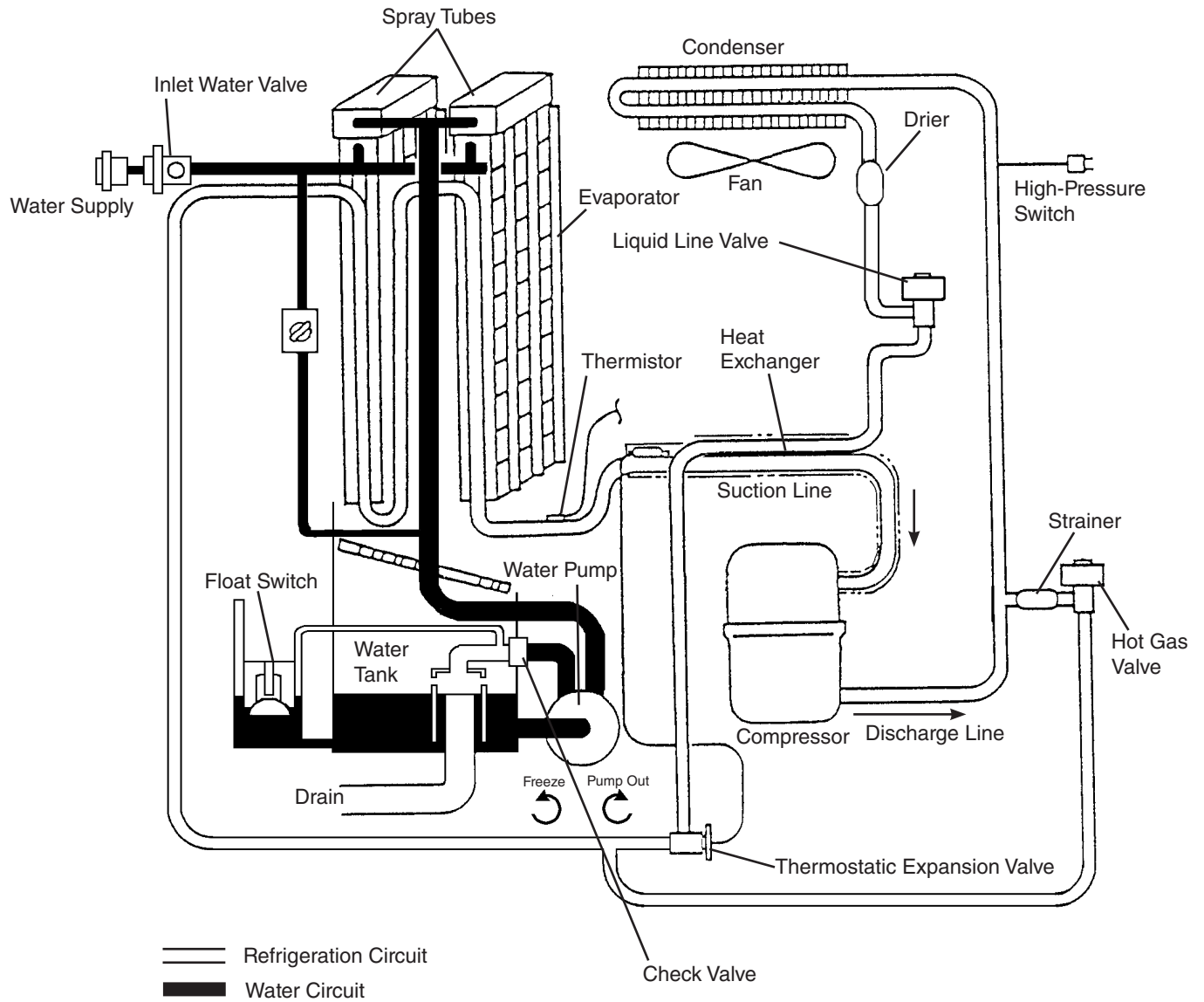

1b. Air-Cooled Models (MAJ)

Auxiliary Code: P-3 and Later (KM-901MAJ, KM-1100MAJ)

Auxiliary Code: P-0 and Later (KM-1340MAJ)

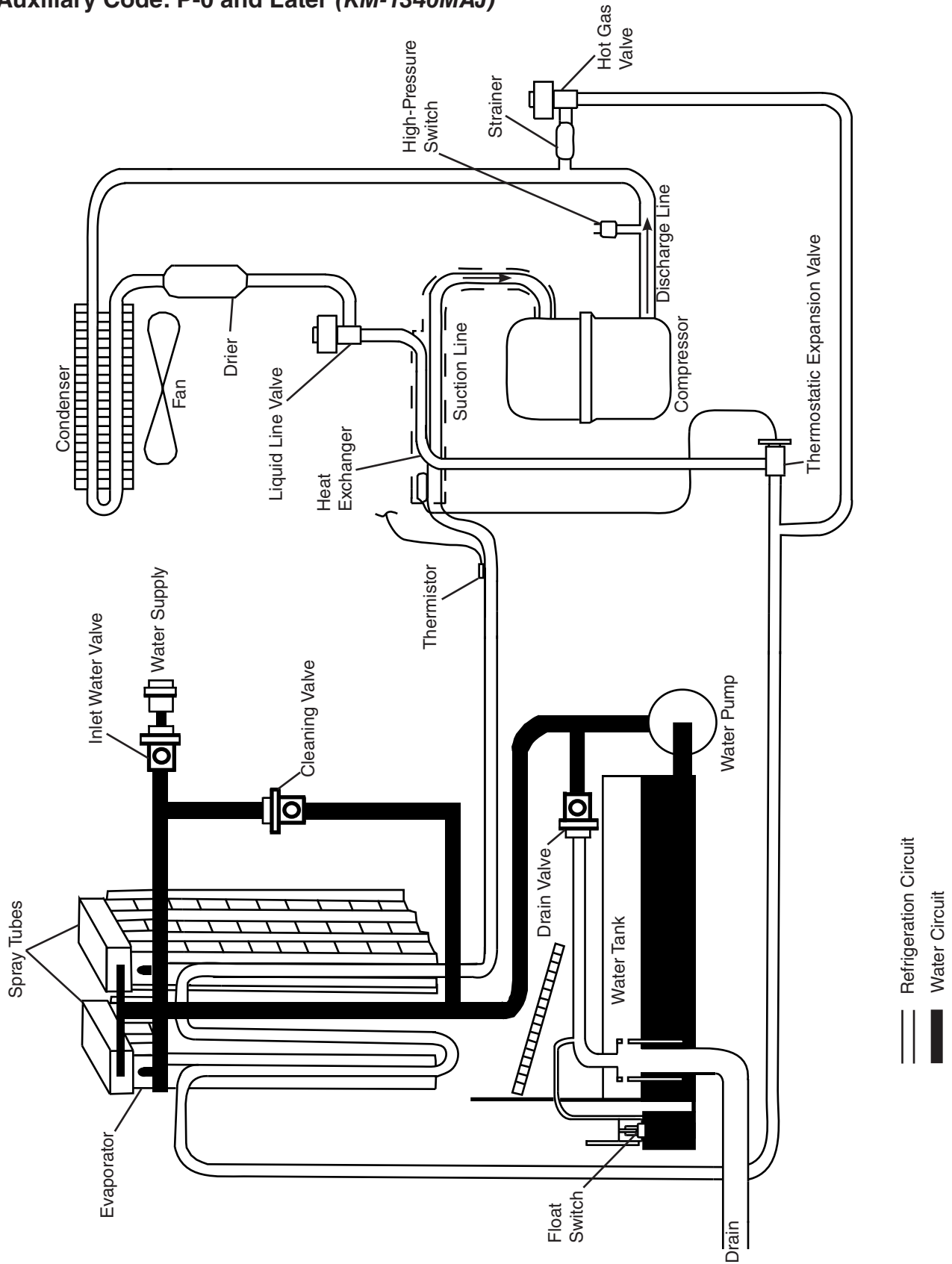

2a. Water-Cooled Models (MWJ)

Auxiliary Code: P-2 and Earlier (KM-901MWJ, KM-1100MWJ)

Auxiliary Code: N-3 and Earlier (KM-1340MWJ)

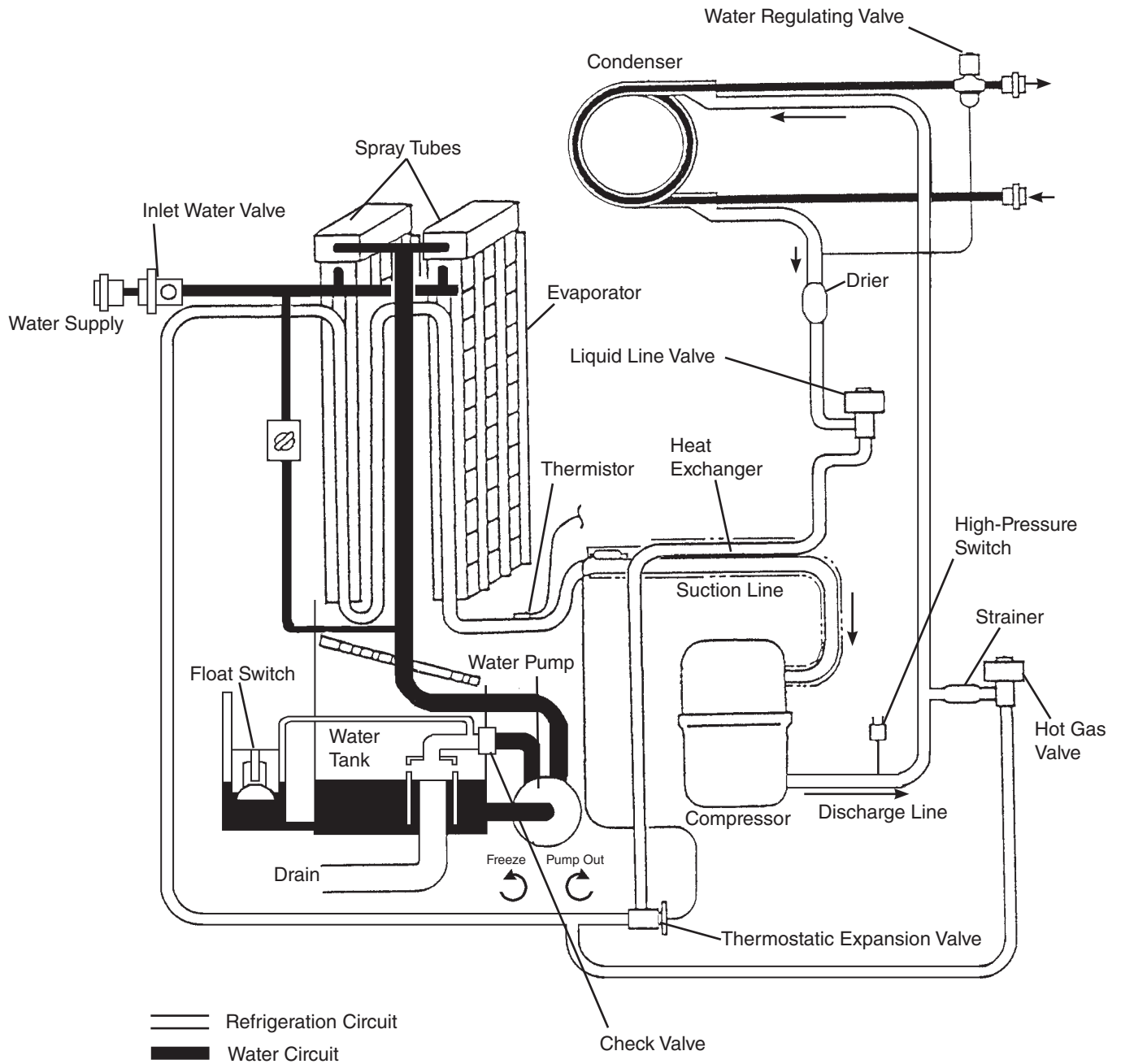

2b. Water-Cooled Models (MWJ)

Auxiliary Code: P-3 and Later (KM-901MWJ, KM-1100MWJ)

Auxiliary Code: P-0 and Later (KM-1340MWJ)

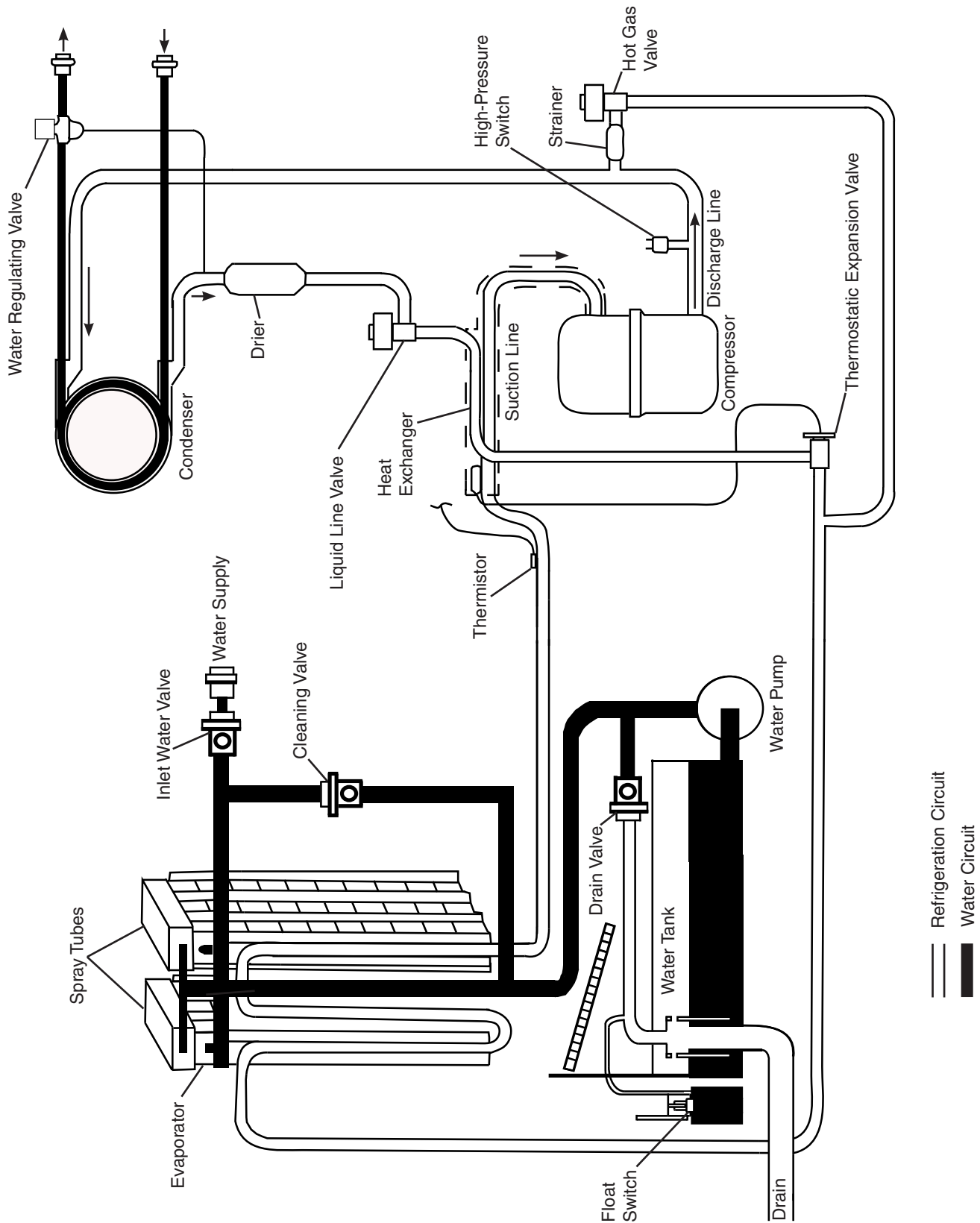

3a. Remote Models (MRJ(Z)/3)

Auxiliary Code: P-2 and Earlier (KM-901MRJ(Z)/3, KM-1100MRJ(Z))

Auxiliary Code: N-3 and Earlier (KM-1340MRJ(Z)/3, KM-1601MRJ(Z)/3)

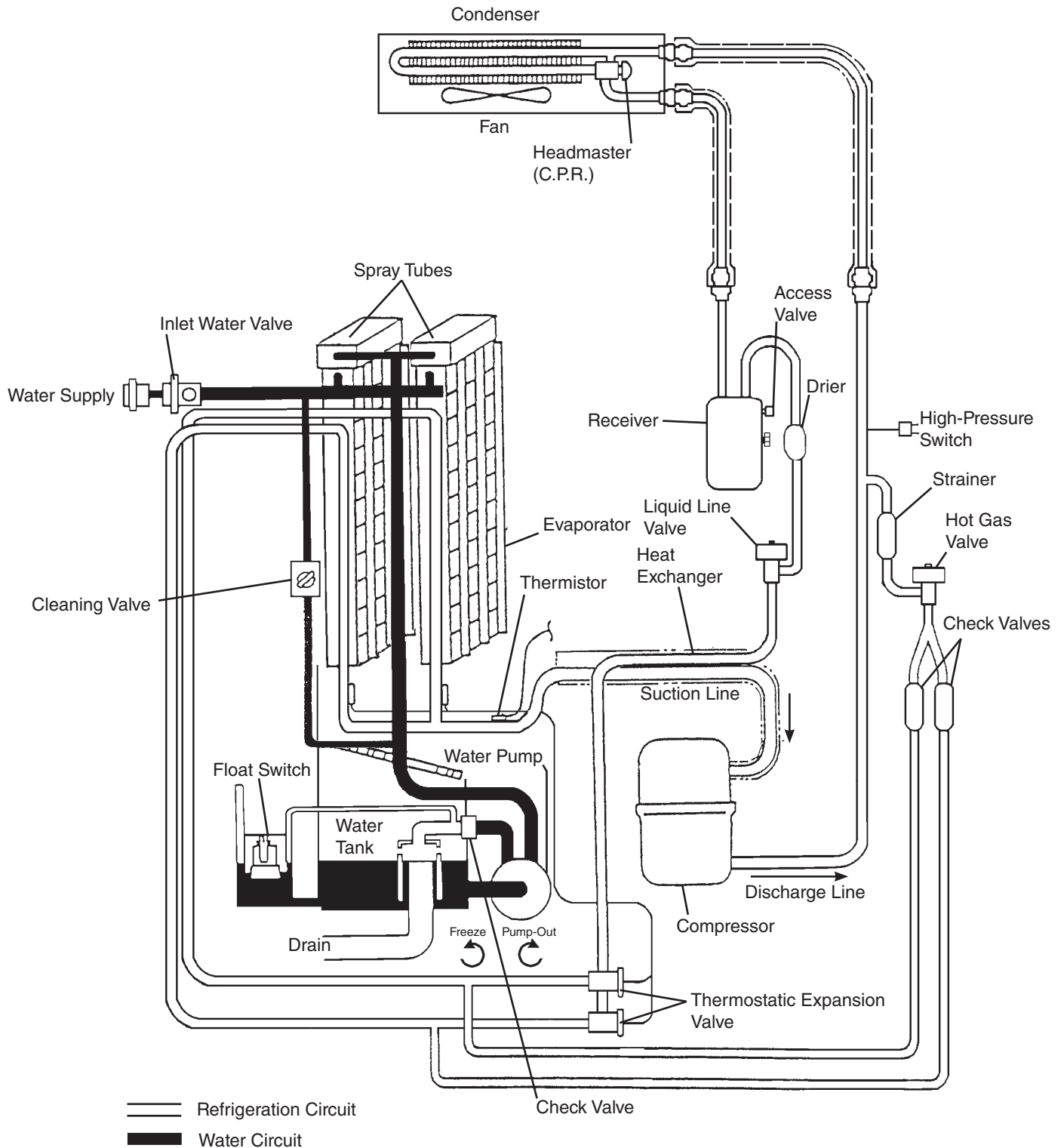

3b. Remote Models (MRJZ/3)

Auxiliary Code: P-3 and Later (KM-901MRJZ/3, KM-1100MRJZ)

Auxiliary Code: P-0 and Later (KM-1340MRJZ/3, KM-1601MRJZ/3)

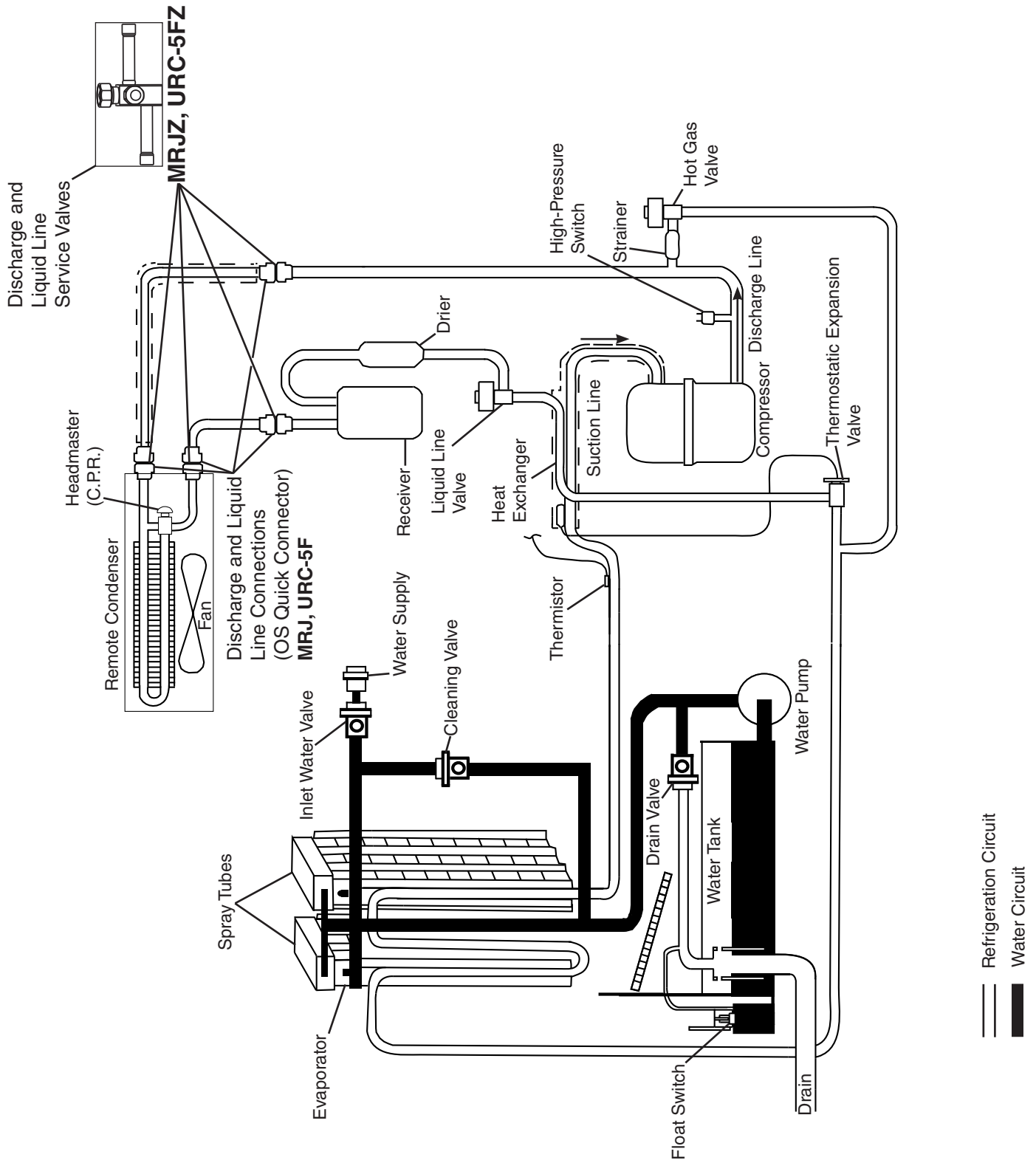

II. Sequence of Operation and Service Diagnosis

A. Sequence of Operation Flow Chart

1a. Operation Flow Chart

Auxiliary Code: P-2 and Earlier (KM-901M_J(Z)/3, KM-1100)

Auxiliary Code: N-3 and Earlier (KM-1340M_J(Z)/3, KM-1601MRJ(Z)/3)

Operation Flow Chart

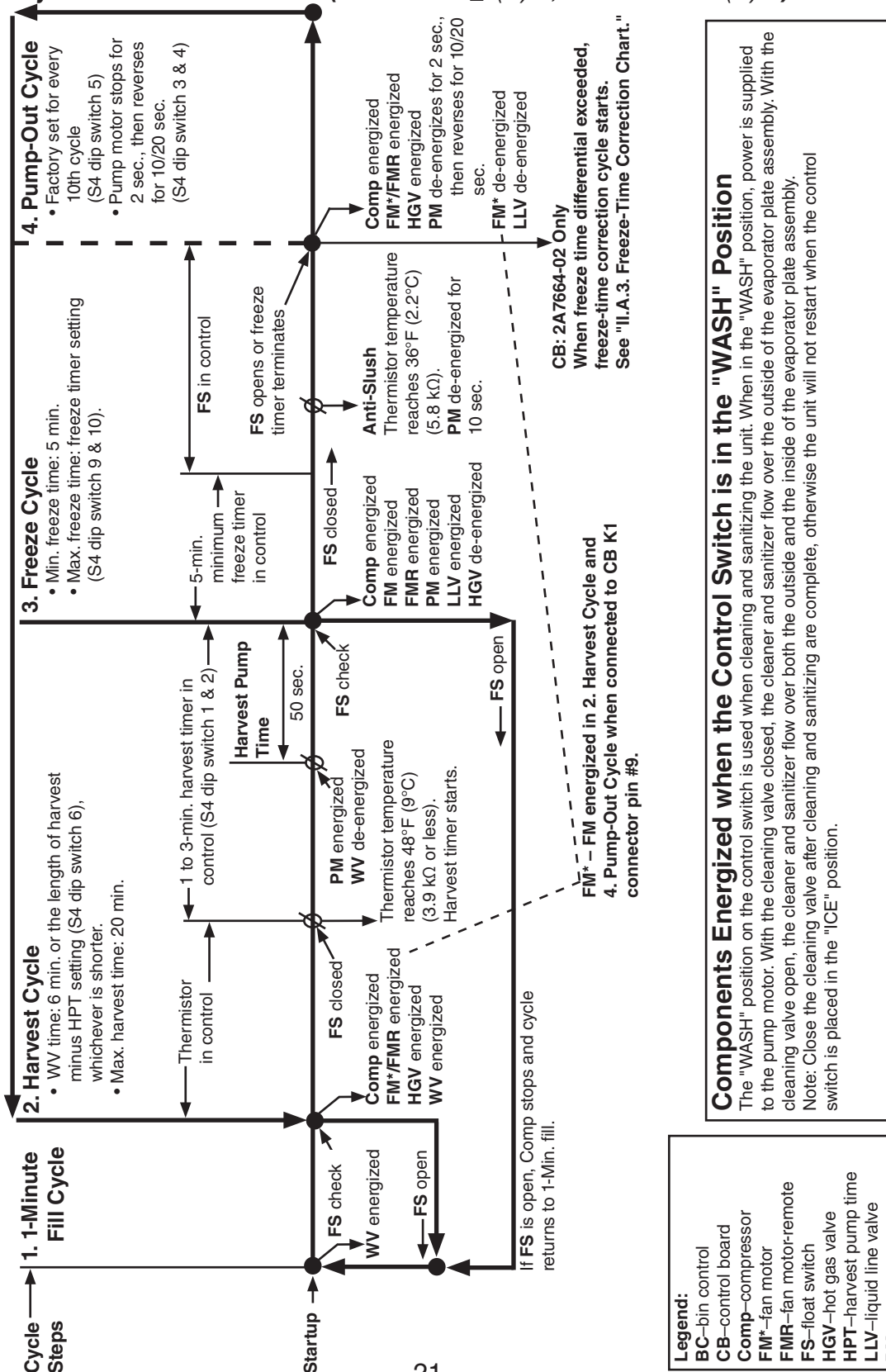

1b. Operation Flow Chart

Auxiliary Code: P-3 (KM-901M_J(Z)/3, KM-1100)

Auxiliary Code: P-0 (KM-1340M_J(Z)/3, KM-1601MRJ(Z)/3)

1/2

Operation Flow Chart

Control Board
2A9678-01

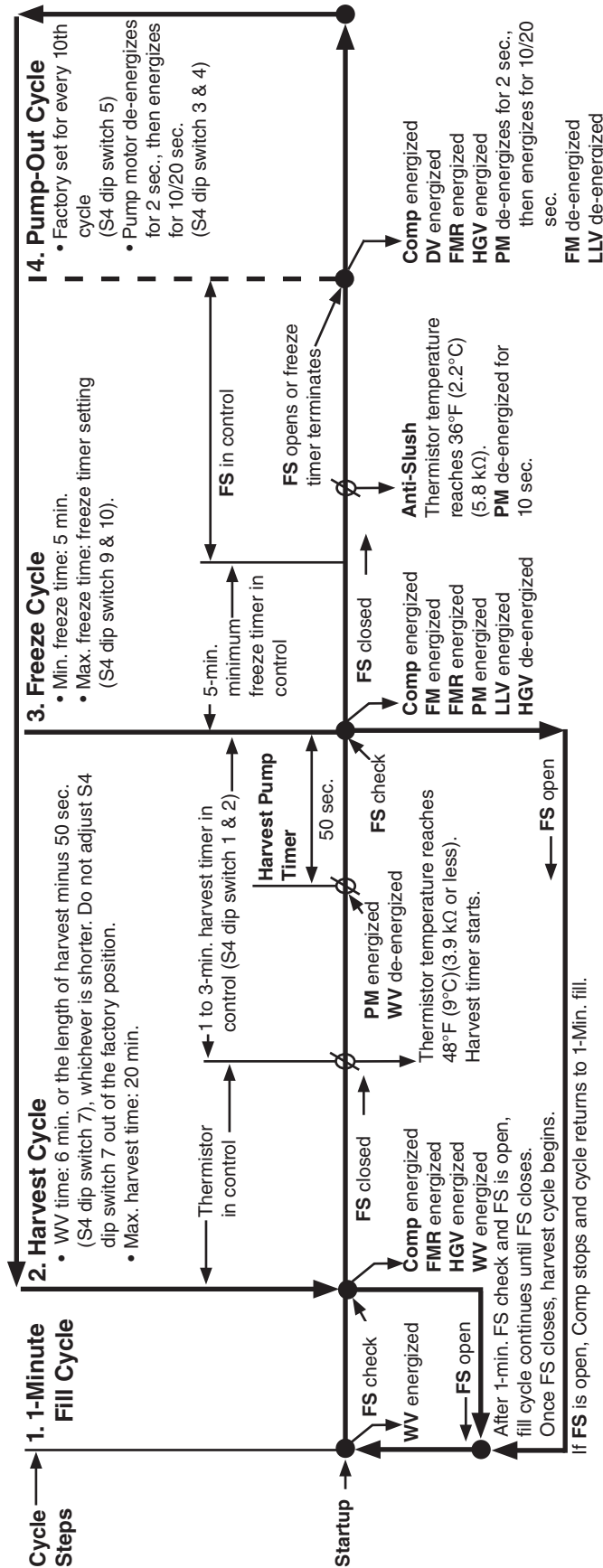

Legend:

- Comp—compressor
- DV—drain valve
- FM—fan motor
- FMR—fan motor-remote
- FS—float switch
- HGV—hot gas valve
- LLV—liquid line valve
- PM—pump motor
- WV—inlet water valve

Components Energized when the Control Switch is in the "PUMP" Position
When the control switch is in the "PUMP" position, power is supplied to the pump motor. Water tank contents then flows over the outside of the evaporator plate assembly. Note: Water tank contents does not flow in-between the evaporator plates.

Components Energized when the Control Switch is in the "ON" or "PUMP" position and the Mode Switch is in the "CLEAN" Position

- When the control switch is in the "ON" position and the mode switch is in the "CLEAN" position, power is supplied to the control board K9 connector. The control board then initiates a clean/sanitize program. See the maintenance label on the top cover or the instruction manual for details.
- When the control switch is in the "PUMP" position and the mode switch is in the "CLEAN" position, only the pump motor energizes and circulates. The Clean/Sanitize program cannot initiate in this scenario. This switch position allows for additional circulation of the water tank contents.

1b. Operation Flow Chart with Freeze-Up Detection

Auxiliary Code: P-4 and Later (KM-901M_J(Z)/3, KM-1100)

Auxiliary Code: P-4 and Later (KM-1340M_J(Z)/3, KM-1601MRJ(Z)/3)**

2/2

Operation Flow Chart

Control Board
2A9678-02

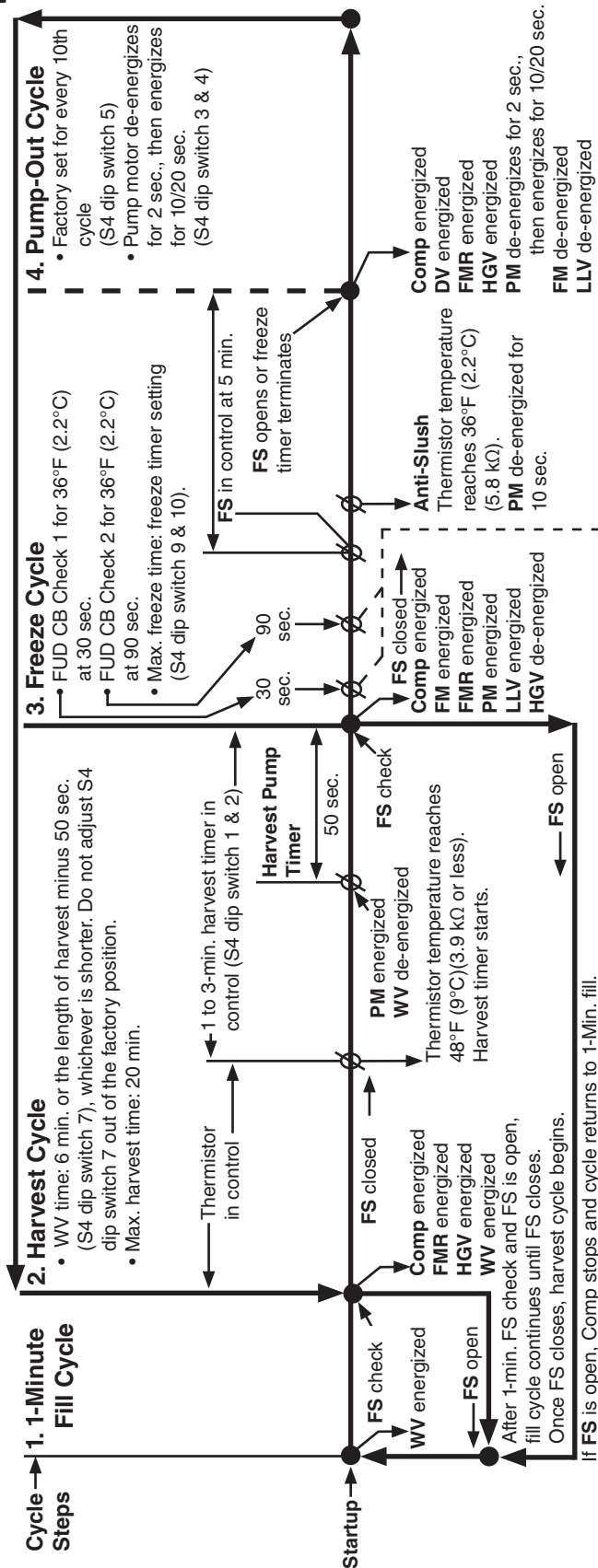

Legend:
 Comp—compressor
 DV—drain valve
 FM—fan motor
 FMR—fan motor-remote
 FS—float switch
 FUD—freeze up detection
 HGV—hot gas valve
 LLV—liquid line valve
 PM—pump motor
 WV—inlet water valve

Components Energized when the Control Switch is in the "PUMP" Position
 When the control switch is in the "PUMP" position, power is supplied to the pump motor. Water tank contents then flows over the outside of the evaporator plate assembly. Note: Water tank contents does not flow in-between the evaporator plates.

Components Energized when the Control Switch is in the "ON" or "PUMP" position and the Mode Switch is in the "CLEAN" Position

- When the control switch is in the "ON" position and the mode switch is in the "CLEAN" position, power is supplied to the control board K9 connector. The control board then initiates a clean/sanitize program. See the maintenance label on the top cover or the instruction manual for details.
- When the control switch is in the "PUMP" position and the mode switch is in the "CLEAN" position, only the pump motor energizes and circulates water tank contents over the outside of evaporator plate assembly, as the control board power supply has been disconnected. The Clean/Sanitize program cannot initiate in this scenario.

2a. Shutdown Flow Chart

Auxiliary Code: P-2 and Earlier (KM-901M_J(Z)/3, KM-1100M_J(Z))

Auxiliary Code: N-3 and Earlier (KM-1340M_J(Z)/3, KM-1601MRJ(Z)/3)

Shutdown Flow Chart

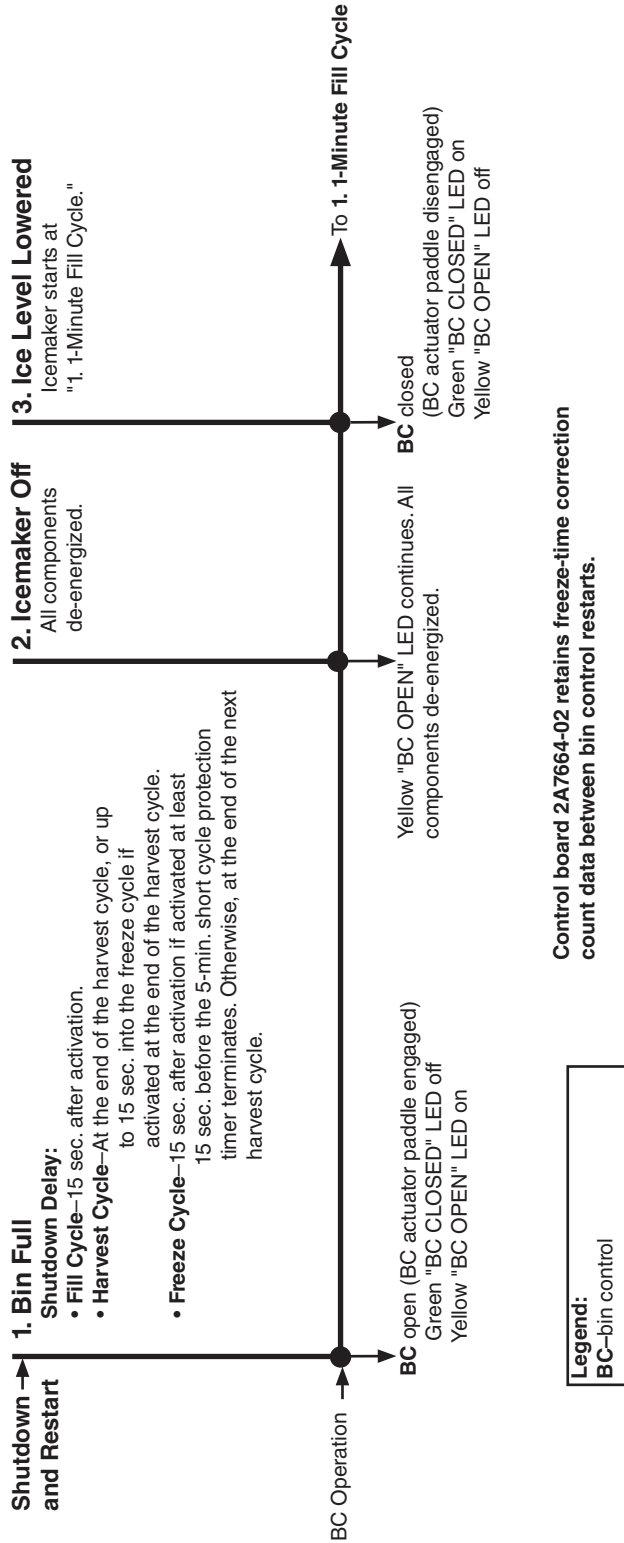

2b. Shutdown Flow Chart

Auxiliary Code: P-3 and Later (KM-901M_J(Z)/3, KM-1100M_J(Z))

Auxiliary Code: P-0 and Later (KM-1340M_J(Z)/3, KM-1601MRJZ/3)

Shutdown Flow Chart

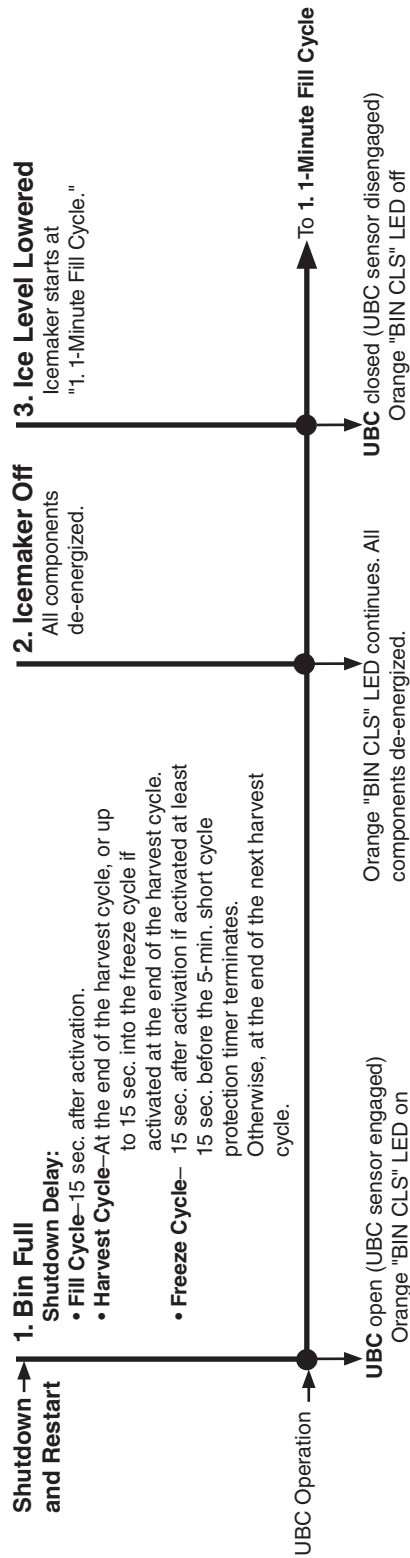

Legend:
 UBC—ultrasonic bin control

• Control board 2A9678-02 retains freeze-up detection count data between bin control restarts.

3. Freeze-Time Correction Chart - Control Board 2A7664-02 Only

Freeze-Time Correction Flow Chart - Control Board 2A7664-02 Only

Freeze Time Differential Exceeded. Minimum and Maximum Freeze times have exceeded differential parameters.

Freeze-Time Correction function is enabled when S4 Dip Switch 7 is in the "ON" position. CB monitors freeze time. After 3 freeze cycles, CB compares the minimum and maximum differential of the 3 freeze cycle times. Every freeze cycle time after the third freeze cycle time is added to the minimum/maximum calculation.

Example: After 8 cycles, if the differential between the shortest cycle (minimum) and the longest cycle (maximum) is equal to or greater than 427 sec. a freeze-time correction cycle is initiated:

Number of Freeze Cycles	Differential Value in Sec.
3	254
4	309
5	349
6	380
7	406
8	427
9	446
10	462

Note: When 1st freeze-time correction cycle is initiated, CB "POWER OK" LED starts blinking. On 2nd freeze-time correction cycle, if CB "POWER OK" LED has been reset, CB "POWER OK" LED starts blinking. If CB "POWER OK" had not been reset after 1st freeze-time correction cycle CB "POWER OK" LED continues to blink. After 3rd freeze-time correction cycle in 36 hours, CB yellow "EXT HARVEST" LED starts blinking. Appliance continues to operate and LEDs continue to blink until ALARM RESET button is pressed with power on.

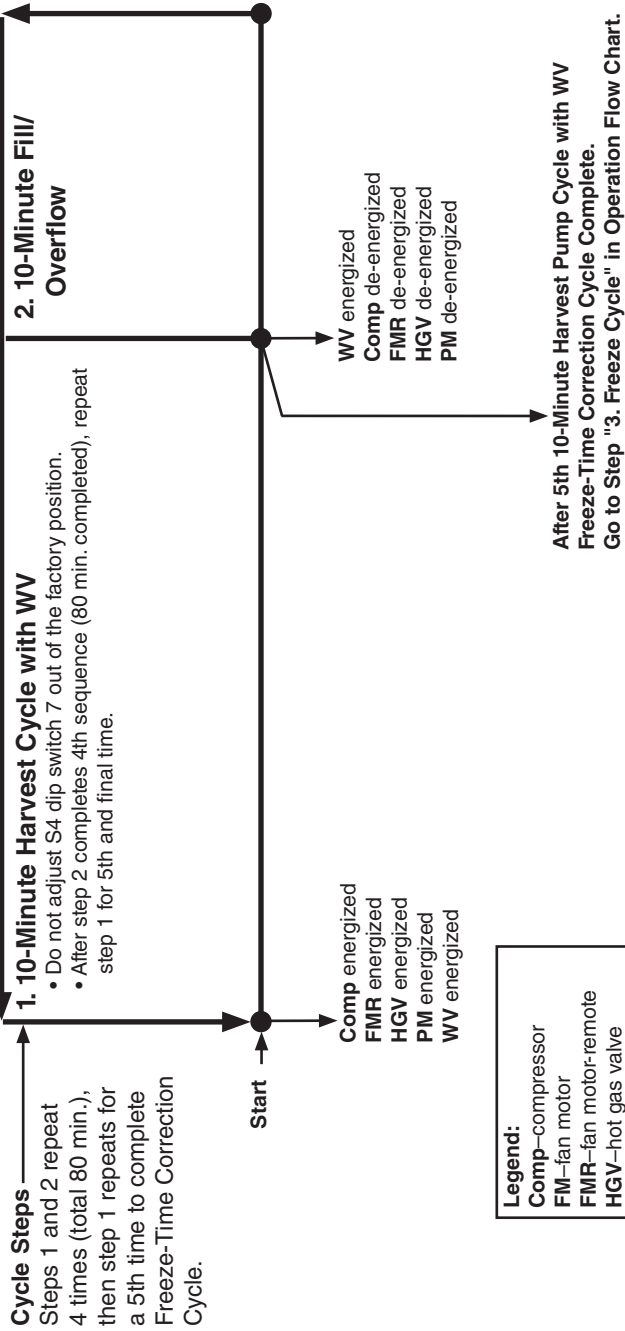

Legend:
 Comp—compressor
 FM—fan motor
 FMR—fan motor-remote
 HGV—hot gas valve
 PM—pump motor
 WV—inlet water valve

Appliance Cycle Reset and Alarm Reset:

Cycle Reset: Power Supply or Control Switch Turned Off and On again: Appliance turns off, then re-starts at 1.Fill Cycle.
Alarm Reset: CB "ALARM RESET" pressed during or after a freeze-time correction cycle with power supply on: Appliance continues cycle with no interruption or reset.
 CB red "POWER OK" LED blinking:
 CB red "POWER OK" LED resets to solid.
 CB yellow "EXT HARVEST" LED blinking:
 CB yellow "EXT HARVEST" LED turns off.

4. Freeze-Up Detection (FUD) Flow Chart

(Control Board 2A9678-02)

Auxiliary Code: P-4 and Later

FUD Initiated Operation Flow Chart "POWER" LED Blinking FUD Harvest Cycle

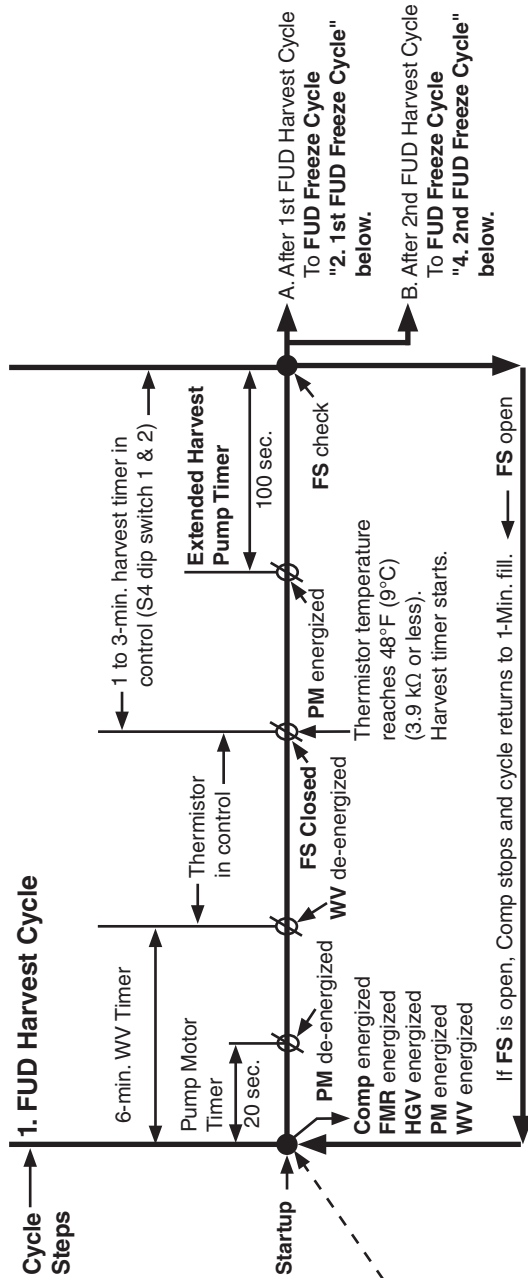

FUD Freeze Cycle

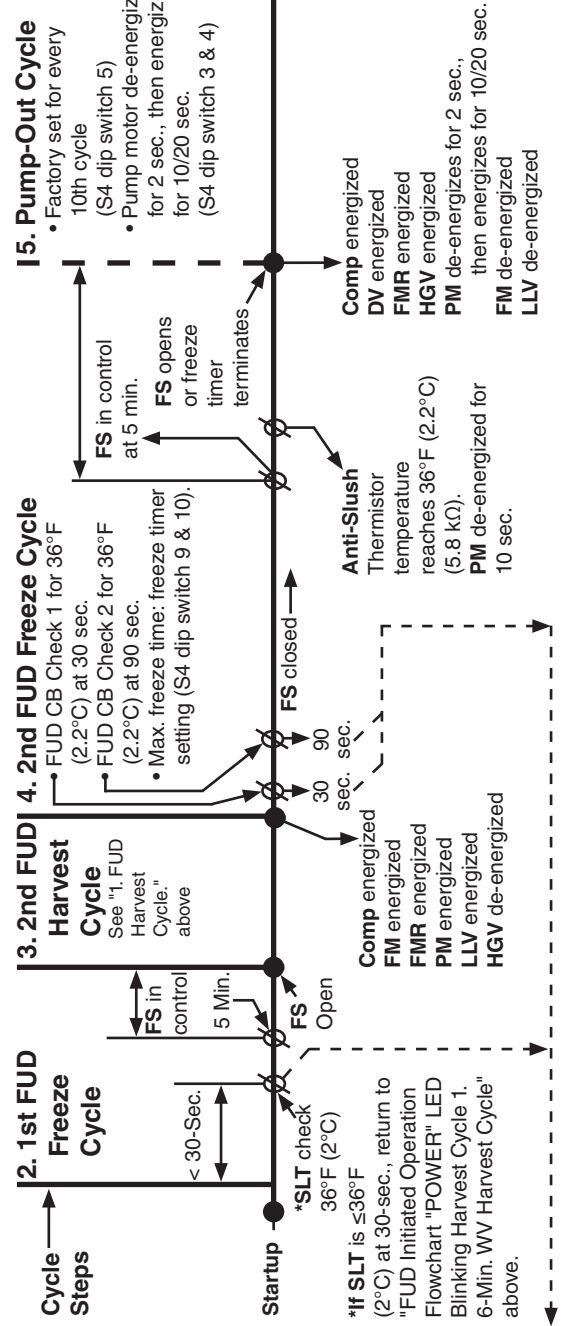

*FUD Initiation - See "II.C.1) for Initiation.

Note:

- "POWER" LED starts blinking when FUD is initiated, and continues until the completion of 6 normal freeze cycles or CB is manually reset. See "II.B.2.c) 5. Appliance Cycle Reset."
- In case of three consecutive FUD harvest cycle initiations in a row, the next cycle will be a normal FS activated freeze cycle (no SLT check), followed by a normal thermistor activated harvest cycle. "Power" LED continues to blink.

Legend:	CB—control board
Comp—compressor	FM—fan motor
FMR—fan motor-remote	FS—float switch
FUD—freeze up detection	HGV—hot gas valve
PM—pump motor	SLT—suction line temperature
WV—inlet water valve	

B. Service Diagnosis

1. Auxiliary Code: P-2 and Earlier (KM-901M_J(Z)/3, KM-1100M_J(Z))

Auxiliary Code: N-3 and Earlier (KM-1340M_J(Z)/3, KM-1601MRJ(Z)/3)

WARNING

- The appliance should be diagnosed and repaired only by qualified service personnel to reduce the risk of death, electric shock, serious injury, or fire.
- Risk of electric shock. Control switch in "OFF" position does not de-energize all loads Use extreme caution and exercise safe electrical practices.
- Moving parts (e.g., fan blade) can crush and cut. Keep hands clear.
- Before servicing the appliance, move the control switch to the "OFF" position and turn off the power supply.
- **CHOKING HAZARD:** Ensure all components, fasteners, and thumbscrews are securely in place after the appliance is serviced. Make sure that none have fallen into the dispenser unit/ice storage bin.
- Make sure all food zones in the appliance and dispenser unit/ice storage bin are clean after service.

The diagnostic procedure is a sequence check that allows you to diagnose the electrical system and components. Before proceeding, check for correct installation, proper voltage per nameplate, and adequate water supply. Check CB using the steps in "II.D. Control Board Check." Check dip switch settings to assure that S4 dip switches and S5 dip switches 1 through 5 are in the factory default position. S4 dip switch 1, 2, 3, 4, and 5 are cleaning adjustments and the settings are flexible. For factory default settings, see "III.C.1a. Default Dip Switch Settings."

Note: • On 208-230/60/1 models with main transformer and 208-230/60/3 models, the appliance neutral (W) is provided through the main transformer. To confirm a good neutral, check for 60VAC from white (W) neutral to ground (GND). If 60VAC is present, neutral is good. If 60VAC is not present, check 208-230VAC main power supply to main transformer. If 208-230VAC is present, check main transformer continuity.

- When checking voltage from the CB K1 connector (10 pin connector), pull CB K1 connector out slightly to allow room for multimeter test leads contact.

- 1) Turn off the power supply, then access the control box. Move the control switch to the "OFF" position. Clear any ice from BC bulb.
- 2) Check that BC is closed and the 115VAC 10A fuse is good.

a) Sequence and Component Diagnosis

- 3) **Power On:** Turn on the power supply, then move the control switch to the "ICE" position. A 5-sec. delay occurs. CB red "POWER OK" LED and CB green "BC CLOSED" LED turn on. If CB yellow "BC OPEN" LED is on (indicating a full bin), check CB K4 red jumper. Move ice away from BC bulb.

Note: • CB red "POWER OK" LED remains on unless the 10.5VAC power supply is interrupted (K2 connector).

- Check CB using the steps in "II.D. Control Board Check."
- Confirm CB green "BC CLOSED" LED is on. If CB yellow "BC OPEN" LED is on, confirm CB K4 jumper is in place. Otherwise, CB yellow "BC OPEN" LED is on and appliance will not start.

a) **Power On Diagnosis:** If CB red "POWER OK" LED is off, confirm 10A fuse is good. Check for 115VAC at control switch #1 (BR) to neutral (W) then at control switch #2 (P) to neutral (W). If 115VAC is present on #1 (BR) and not on #2 (P), replace control switch. If 115VAC is present on control switch #2 (P), check for 115VAC at HPS (P) to neutral (W) then HPS (BK) to neutral (W). If 115VAC is present at HPS (P) and not at HPS (BK), HPS is open. See HPS Diagnosis below. If 115VAC is present at HPS (BK), check for 10.5VAC at CB K2 #1 red wire to CB K2 #2 red wire. If 10.5VAC is not present, check that the cleaning valve is closed and the interlock switch is closed. Next, check CT continuity. If open, replace CT.

b) **HPS Diagnosis:** Check that the condenser coil is not clogged or restricted. Let refrigeration circuit pressures equalize. If HPS does not reset and pressures are equalized, replace HPS. If pressures are not equalized, reclaim refrigerant and diagnose refrigeration circuit restriction. Check that there are no restrictions in the refrigeration circuit.

Harvest Cycle: HGV, strainer, or check valve.

Freeze Cycle: FM, FMR, TXV, WRV, HM, LLV, strainer, check valve, drier, and damaged line set or fitting.

Confirm that the location meets installation requirements:

- The appliance is not intended for outdoor use. Normal operating ambient temperature should be within 45°F to 100°F (7°C to 38°C).
- Allow 6" (15 cm) clearance at rear, sides, and top for proper air circulation and ease of maintenance and/or service should they be required.
- The appliance should not be located in a corrosive environment.

- 4) **1-Min. Fill Cycle – LED 4 is on.** WV and X11 relay energize. After 1 min., CB checks for a closed FS. If FS is closed, the harvest cycle begins. If harvest cycle begins (Comp, HGV, FM*, FMR energized), continue to step 5a. If FS is open, WV remains energized until FS closes (low water safety protection during initial start up and at the end of each harvest). **Diagnosis:** Check that water enters the water tank. If not, check that the water supply line shut-off valve is open and screens or external filters are clear. Check for 115VAC at CB K1 #6 (O) to neutral (W). If 115VAC is not present, replace CB. If 115VAC is present, and WV does not energize, check for 115VAC at WV. If 115VAC is present, check coil continuity. If open, replace WV. If the water tank fills, but the appliance fails to start harvest (Comp energized), check for open FS. See "II.F. Float Switch Check and Cleaning." If FS is closed and CB fails to start the harvest cycle after 1 min., replace CB.
- 5a) **Initial Harvest Cycle – LEDs 1, 4, and 2 are on.** WV and X11 relay continue. Comp, FM* (if connected to CB K1 connector pin #9), FMR, HGV, and X10 relay energize. CB monitors the warming of the evaporator via the thermistor located on the suction line. When the thermistor reaches 48°F (9°C), CB reads 3.9 kΩ from the thermistor and turns harvest termination over to the harvest timer (S4 dip switch 1 & 2 and S5 dip switch 4). WV and X11 relay are energized during harvest for a maximum of 6 min. or the length of harvest minus HPT setting (S4 dip switch 6), whichever is shorter. See step 5b below.
- a) **Comp Diagnosis:** Check that evaporator is warming. If not, confirm that Comp energizes. If not, check for 115VAC at CB K1 #1 or #9 (V) to neutral (W). If 115VAC is not present, check for 115VAC at CB K1 #7 or #10 (BR) to neutral (W). If 115VAC is present at #7 or #10 (BR) and not at #1 or #9 (V), replace CB. If 115VAC is present, check for 115VAC at CR or MC solenoid. If 115VAC is present, confirm contacts are closed. If not, replace CR or MC. If CR or MC contacts are closed, check Comp external overload, Comp start and run capacitors, Comp start relay, and Comp motor winding.
- b) **HGV Diagnosis:** If Comp is energized and evaporator is not warming, check that HGV energizes and opens. Check for 115VAC at CB K1 #2 (P) to neutral (W). If 115VAC is not present, replace CB. If 115VAC is present, check for 115VAC at HGV coil and check HGV coil continuity. Replace as needed.
- c) **LLV Diagnosis:** Confirm that LLV is de-energized and closed (not bypassing). If energized, replace CB. If de-energized and bypassing, replace LLV.
- d) **WRV Diagnosis:** Confirm WRV is not leaking by. If WRV is leaking by, confirm HGV is open and LLV is closed. Next, check for proper refrigerant pressures. If refrigerant pressures are correct, adjust or replace WRV. See "IV.C. Water Regulating Valve Adjustment (water-cooled models).

5b) **Harvest Pump Timer – LEDs 1, 3, and 2 are on.** When the thermistor reaches 48°F (9°C), CB reads 3.9 kΩ from the thermistor and turns harvest termination over to the harvest timer (S4 dip switch 1 & 2 and S5 dip switch 4). When WV de-energizes, LED 4 turns off, X11 relay de-energizes and LED 3 turns on. PM energizes. Comp, FM*, FMR, HGV, and X10 relay continue.

Diagnosis: Place a thermometer on the suction line next to the thermistor. Has it warmed to 48°F (9°C) or warmer? Confirm thermistor status. See "II.G. Thermistor Check." If the thermistor reading is in proper range, dip switch 7 is on, and PM does not energize before harvest terminates, replace CB. If WV continues, check for 115VAC at CB K1 #6 (O). If 115VAC is present, and LED 4 is off, replace CB. If LED 3 is on and PM is not energized, check for 115VAC at CB K1 #5 (DBU). If 115VAC is not present, replace CB. If 115VAC is present and PM is not energized, check for 115VAC at X10 relay terminal #7 (Y) to neutral (W). If 115VAC is not present, check for 115VAC at X10 relay terminal #3 (P) to neutral (W) and X10 relay terminal #5 (Y) to neutral (W). If 115VAC is present on terminal #3 (P) and not on terminal #5 (Y), replace X10 relay. If 115VAC is present on X10 relay terminal #7 (Y) and PM is not energized, check for 115VAC at X10 relay terminal #4 (R) to neutral (W) and terminal #6 (DBU) to neutral (W). If 115VAC is present on terminal #6 (DBU) and not on terminal #4 (R), replace X10 relay. If 115VAC is present on X10 relay terminal #4 (R), check control switch contact continuity between terminals #4 (R) and #5 (W/R). If contacts are open, replace control switch. If contacts are closed and 115VAC is present between control switch terminal #5 (W/R) and neutral (W), check PM capacitor and motor winding continuity.

5c) **Initial Harvest Cycle Termination Diagnosis:** When the thermistor reaches 48°F (9°C), CB reads 3.9 kΩ from the thermistor and turns harvest termination over to the harvest timer (S4 dip switch 1 & 2 and S5 dip switch 4). Check discharge line temperature. For a thermistor check, see "II.G. Thermistor Check." If 1-min. fill cycle starts after harvest timer terminates, check that FS is clean and operating properly, see "II.F. Float Switch Check and Cleaning." If FS is closed, CB proceeds to the next cycle. If not, replace CB.

Note: The minimum total time allowed by CB for a complete harvest cycle is based on S5 dip switch 4. Maximum harvest time allowed is 20 min.

NOTICE! S4 dip switch 7 must remain on. Otherwise, PM will not energize during the last seconds of harvest.

6) **Freeze Cycle – LED 1 is on.** Comp, FM*, FMR, and PM continue. FM and LLV energize. HGV and X10 relay de-energize. Appliance is held in freeze by a 5-min. short cycle protection timer. After 5-min. short cycle protection timer terminates and FS opens, freeze cycle terminates.

Note: PM power supply switches from CB K1 #5 (DBU) in harvest to K1 #4 (R) in freeze.

Anti-Slush: When anti-slush is enabled (S5 dip switch 5 "ON"), PM de-energizes when thermistor reaches 36°F (2.2°C) (5.8kΩ) for 10 sec. then, energizes for the remainder of the freeze cycle.

- a) **Freeze Cycle Diagnosis:** Confirm Comp, FM*, FMR, and PM continue. Confirm that FM and LLV energize. Confirm WRV opens. Next, confirm HGV and X10 relay de-energize. During the first 5 min. of freeze, confirm evaporator is cooling. If not, confirm WV de-energized (not leaking by), HGV de-energized (not bypassing), LLV and FM energize, TXV and HM operate correctly, WRV opens, Comp is efficient, and refrigerant charge is correct. See "VIII.A. Specification and Performance Data Sheets."
- b) **Comp, FM*, and FMR Diagnosis:** If Comp, FM*, and FMR de-energize once freeze begins, check that appliance has not shut off on HPS ("POWER OK" LED off). If so, check "3)b HPS Diagnosis" above. If CB "POWER OK" LED is on, check for 115VAC at CB K1 #1 (V) or #9 (V) to neutral (W). If 115VAC is not present and LED 1 is on, replace CB. If 115VAC is present, check for 115VAC at CR or MC coil. If 115VAC is present, check CR or MC coil and contact continuity. Replace as needed. If CR or MC is okay, check Comp start relay and start and run capacitors. Next, check Comp motor winding continuity. If Comp is energized but evaporator is not cooling, check for an inefficient Comp. See "VIII.A. Specification and Performance Data Sheets."
FM* Diagnosis: If Comp is energized but FM* is not, check CB K1 #1 (V) and #9 (V) wiring circuit for loose connection. If connections are good, check FM* capacitor, motor winding, and blade for binding.
FMR Diagnosis: If Comp is energized but FMR is not, check for 115VAC at the FMR junction box. If 115VAC is not present, check icemaker wiring connections. If 115VAC is present, check for voltage at condenser unit. If 115VAC is not present, check field wiring connections. If 115VAC is present, check FMR capacitor, motor winding, and fan blade for binding.
- c) **WV and HGV Diagnosis:** If WV is energized, check for 115VAC at CB K1 #6 (O) to neutral (W). If 115VAC is present after PM energizes in harvest cycle, replace CB. If 115VAC is not present, replace WV (bypassing). If HGV did not de-energize at the end of harvest, check for 115VAC at CB K1 #2 (P) to neutral (W). If 115VAC is present 50 sec. after PM energizes, replace CB. If 115VAC is not present, replace HGV (bypassing).
- d) **PM Diagnosis:** Confirm water is flowing over evaporator from PM and not WV. If PM de-energizes once freeze begins, check for 115VAC at CB K1 #4 (R) to neutral (W). If 115VAC is not present, replace CB. If 115VAC is present and PM is de-energized, check for 115VAC at control switch #5 (W/R) to neutral (W). If 115VAC is present at CB K1 #4 (R) and not at control switch #5 (W/R), check control switch continuity between #5 (W/R) and #4 (R). Replace as needed. If 115VAC is present at control switch #5 (W/R) to neutral (W), check PM capacitor and motor winding continuity.
- e) **FM and LLV Diagnosis:** If FM or LLV does not energize, check for 115VAC at CB K1 #3 (BK) to neutral (W). If 115VAC is not present, replace CB. If 115VAC is present: For FM, check capacitor, motor winding, and blade for binding. For LLV, check coil voltage and continuity.

- f) **Refrigerant Pressures, HM, and TXV Diagnosis:** If evaporator is still not cooling, check refrigerant pressures. See "VIII.A. Specification and Performance Data Sheets." Next, check HM operation. If refrigeration pressures are above HM setpoint and HM is bypassing, replace HM. Check TXV for proper operation. Remove TXV bulb and hold it in your hand, refrigerant low-side pressure should rise, place TXV bulb in ice water, refrigerant low-side pressure should drop. A 10 to 15 pound pressure swing between warm and cold conditions indicate a good TXV. If a 10 to 15 pound swing is not present, replace TXV.
- g) **WRV Diagnosis:** WRV is factory set and generally no adjustment is required. If WRV fails to open in freeze, check for proper refrigerant pressures. See "VIII.A. Specification and Performance Data Sheets." If refrigerant pressures are correct and WRV does not open, adjust or replace as needed. See "IV.C. Water Regulating Valve Adjustment (water-cooled models)."
- h) **Freeze Termination Diagnosis:** After 5 min. in freeze, disconnect CB K5 FS connector. 15 sec. later appliance should switch out of the freeze cycle (15 second delay after FS opens before terminating the freeze cycle). If appliance remains in freeze longer than 15 sec. after FS removed, replace CB. If appliance switches with FS removed but would previously not switch out of freeze with FS connected (long freeze - 3 beep alarm), see "II.F. Float Switch Check and Cleaning."
- Note: Normal freeze cycle will last 20 to 40 min. depending on model and conditions. Cycle times and pressures should follow performance data provided in this manual. See "VIII.A. Specification and Performance Data Sheets."
- i) **Short Freeze Cycle Diagnosis:** Confirm water tank fills and overflows during 1 min. fill and harvest cycles. If not, check water supply filters, shut-off valve, WV screen. If water tank empties before 5 min. timer terminates and freeze cycle is short, check that CV is not leaking by (water flowing down the potable drain). If CV is leaking by, remove and clean CV, replace rubber seat and spring if necessary. If water tank is full, see "II.F. Float Switch Check and Cleaning." for erratic operating FS.
- 7) **Pump-Out Cycle – LEDs 1, 3, and 2 are on (10/20 second pump-out).** Timing of the first pump-out is determined by S4 dip switch 5. See the table below.

Control Board Settings		
S4 Dip Switch Setting	Pump-Out Frequency	Control Board
No. 5		
OFF	Every 10 cycles	After 11th freeze cycle
ON	Every cycle	After 2nd freeze cycle

Comp, FM*, and FMR continue, HGV energize.

Note: If S4 dip switch 3 & 4 are set to 3 off and 4 on, LED 4 turns on and WV and X11 relay energize, energizing X10 relay. **NOTICE! S4 dip switch 3 & 4 must not be set to 3 off and 4 on. Otherwise, PM will rotate in freeze cycle direction instead of pump-out direction.**

FM and LLV de-energize. PM stops for 2 sec., then reverses for 10/20 sec. depending on pump-out timer (S4 dip switch 3 & 4) setting. When the pump-out timer terminates, pump-out is complete. The pump-out frequency control (S4 dip switch 5) is factory set, and generally no adjustment is required. However, the pump-out frequency control can be set to have a pump-out occur every 10 cycles or every cycle. For details, see "III.C.4. Pump-Out Frequency Control (S4 dip switch 5)."

Pump-Out Diagnosis: In the freeze cycle before pump-out (see table above), after 5 min. of freeze disconnect CB black K5 connector (FS connector). Check that PM stops and re-starts. Next, check that PM rotation is correct (water flowing down the drain through CV). If PM does not stop and re-start, check that CB LEDs 1, 3, and 2 are on. If not, replace CB. If LEDs 1, 3, and 2 are on and PM does not energize, check for 115VAC at CB K1 #5 (DBU) to neutral (W). If 115VAC is not present, replace CB. If 115VAC is present, check that X10 relay is de-energized. If not, check X11 relay status. If X11 relay is energized, replace CB. If X11 relay is de-energized and X10 relay is energized, replace X11 relay (contacts sticking). If X10 relay is de-energized, check for 115VAC at terminal #6 (DBU) to neutral (W) and terminal #2 (DBU) to neutral (W). If 115VAC is present on terminal #6 (DBU) and not on terminal #2 (DBU), replace X10 relay. If 115VAC is present on X10 terminal #2 (DBU) and PM is not energized check for 115VAC at X12 terminal #6 (DBU) to neutral (W) and X12 terminal #4 (DBU) to neutral (W). If 115VAC is present on X12 terminal #6 (DBU) and not on X12 terminal #4 (DBU), check for 115VAC at X12 terminal #7 (P) to X12 terminal #8 (W). If 115VAC is not present, check CB K1 pin #2 (P) wiring for loose connection. If 115VAC is present and X12 is not energized, check coil continuity. Replace as needed. If X12 is energized and X12 terminal #4 (DBU) does not have 115VAC, replace X12 relay (contacts sticking). If X12 terminal #4 (DBU) has 115VAC, PM should be energized and rotating in pump-out rotation. If not, check PM motor windings and impeller for binding. If energized and rotating correctly, make sure the drain line is not clogged and that CV is clean and operating properly.

Confirm FM and LLV de-energize. If FM or LLV are energized with LEDs 1, 3, and 2 on, replace CB.

- 8) **Normal Harvest Cycle** – Same as the initial harvest cycle. Return to step 5a) above.
Note: Appliance continues to cycle until MBC is satisfied or power is switched off. The appliance always restarts at the 1-min. fill cycle.

b) Shutdown

- 1) See "II.E.Bin Control Check and Cleaning."

c) Freeze-Time Correction Cycle (90 min.) (Control Board 2A7664-02 Only)

Freeze-Time Correction function is enabled when S4 Dip Switch 7 is in the "ON" position and initiates when the minimum and maximum freeze times have exceeded differential parameters. Freeze-time correction timer and count starts at the beginning of the 2nd freeze cycle after startup from power off condition. Freeze-time correction timer and count continues and retains its freeze-time correction timer and count during a BC off cycle and resumes its freeze-time correction timer and count on the 2nd freeze cycle after BC restart. If freeze-time differential is exceeded (see table below), freeze-time correction cycle starts and CB red "POWER OK" LED blinks. When freeze-time correction cycle occurs 3 or more times within a 36 hour period, CB yellow "EXT HARVEST" LED blinks with CB red "POWER OK" LED. Appliance starts in freeze cycle after a freeze-time correction cycle. To reset CB LEDs, press ALARM RESET button on CB with power on. CB resets LEDs and appliance continues cycle without interruption.

- 1) **Freeze Time Differential Initiation:** CB starts monitoring freeze times on the second freeze time. After 3 freeze cycles (4th total), CB begins to compare minimum and maximum freeze time cycles. Every freeze cycle time after the first freeze cycle time is added to the freeze time list. Minimum and maximum freeze time differential comparisons begin on the third cycle and are monitored up to 10 cycles. On the 11th cycle the first freeze cycle time is dropped to maintain the 10 maximum number of cycles.

Example: After 8 cycles (excluding first cycle), if the differential between the shortest cycle (minimum) and the longest cycle (maximum) is equal to or greater than 427 sec. a freeze-time correction cycle is initiated:

Number of Freeze Cycles	Differential Value in Sec.
3	254
4	309
5	349
6	380
7	406
8	427
9	446
10	462

2) Freeze-Time Correction Sequence:

First occurrence within 36 hr., minimum and maximum freeze times have exceeded differential parameters. CB "POWER OK" LED starts blinking. Freeze-Time Correction Cycle starts.

Second occurrence within 36 hr., minimum and maximum freeze times have exceeded differential parameters. If not reset, CB "POWER OK" LED continues blinking. If reset from first occurrence, CB "POWER OK" LED starts blinking. Freeze-Time Correction Cycle starts.

Third occurrence within 36 hr. minimum and maximum freeze times have exceeded differential parameters. CB yellow "EXT HARVEST" LED starts blinking. Also, If not reset, CB "POWER OK" LED continues blinking. If reset, CB "POWER OK" LED starts blinking. Freeze-Time Correction Cycle starts.

Total freeze-time correction cycle last for 90 min. At the end of 80 min., the final step initiates and final Harvest Pump Time (Harvest Assist) with WV (10-min.) starts. Once the final Harvest Pump Time (Harvest Assist) with WV (10-min.) terminates (90 min. complete), normal freeze cycle begins.

- 2a) **10-Min. Harvest Pump Time (Harvest Assist) with WV:** CB "POWER OK" LED blinking. CB LEDs 1, 4, 3, and 2 are on and Comp, FMR, HGV, PM, and WV energize. 10-min. timer starts. Once 10-min. timer terminates, CB LEDs 1, 3, and 2 turn off and Comp, FMR, HGV, and PM de-energize. WV continues.
- 2b) **10-Min. Fill:** CB LED 4 on and WV energized. 10-min. timer starts.
- 2c) **Final 10-Min. Harvest Pump Time (Harvest Assist) with WV:** CB "POWER OK" LED blinking. Once 10-min. timer terminates, CB LEDs 1, 4, 3, and 2 are on and Comp, FMR, HGV, and PM energizes. WV continues. 10-min. timer starts. Once 10-min. timer terminates, normal freeze cycle begins. CB LED 1 on and Comp, FMR, and PM continue. HGV and WV de-energize.

Note: After 3rd Freeze-Time Correction Cycle in 36 hours, CB signals with blinking CB yellow "EXT HARVEST" LED. Appliance continues normal operation.

CB "POWER OK" LED and CB yellow "EXT HARVEST" LED continue blinking in normal operation sequence.

3) Appliance Cycle Reset and CB Alarm Reset:

Cycle Reset: Power supply or control switch turned off and on again: Appliance turns off, then re-starts at 1. Fill Cycle.

Alarm Reset: CB "ALARM RESET" pressed during or after a freeze-time correction cycle with power supply on: Appliance continues cycle with no interruption or reset.

CB red "POWER OK" LED blinking: CB red "POWER OK" LED resets to solid.

CB yellow "EXT HARVEST" LED blinking: CB yellow "EXT HARVEST" LED turns off.

Legend: **BC**—bin control; **CB**—control board; **Comp**—compressor; **CR**—compressor relay; **CT**—control transformer; **CV**—check valve; **FM**—fan motor; **FMR**—fan motor remote; **FS**—float switch; **HGV**—hot gas valve; **HM**—headmaster (C.P.R.); **HPS**—high-pressure switch; **LLV**—liquid line valve; **PM**—pump motor; **TXV**—thermostatic expansion valve; **WRV**—water regulating valve; **WV**—inlet water valve

2. Auxiliary Code: P-3 and Later (KM-901M_J(Z)/3, KM-1100M_J(Z))

Auxiliary Code: P-0 and Later (KM-1340M_J(Z)/3, KM-1601MRJZ/3)

⚠ WARNING

- The appliance should be diagnosed and repaired only by qualified service personnel to reduce the risk of death, electric shock, serious injury, or fire.
- Risk of electric shock. Control switch in "OFF" position does not de-energize all loads Use extreme caution and exercise safe electrical practices.
- Moving parts (e.g., fan blade) can crush and cut. Keep hands clear.
- Before servicing the appliance, move the control switch to the "OFF" position and turn off the power supply.
- **CHOKING HAZARD:** Ensure all components, fasteners, and thumbscrews are securely in place after the appliance is serviced. Make sure that none have fallen into the dispenser unit/ice storage bin.
- Make sure all food zones in the appliance and dispenser unit/ice storage bin are clean after service.

The diagnostic procedure is a sequence check that allows you to diagnose the electrical system and components. Before proceeding, check for correct installation, proper voltage per nameplate, and adequate water supply. Check CB using the steps in "II.D. Control Board Check." Check dip switch settings to assure that S4 dip switch 3, 4, 7, 8, 9, 10 and S5 dip switch 1 through 5 are in the factory default position. S4 dip switch 1, 2, 5, 6 are cleaning adjustments and the settings are flexible. For factory default settings, see "III.C.1b. Default Dip Switch Settings."

Note: • When checking high voltage (115VAC), always choose a white (W) neutral wire to establish a good neutral connection.

- **MT Check** - On models with a main transformer, the neutral (W) is provided through MT. To confirm a good neutral, check for 60VAC from white (W) neutral to ground (GND). If 60VAC is present, neutral is good. If 60VAC is not present, check 208-230VAC main power supply to MT. If 208-230VAC is present, check MT continuity.
- When checking voltage from the CB K1 connector (10 pin connector), pull CB K1 connector out slightly to allow room for multimeter test leads contact.

- 1) Turn off the power supply, then access the control box. Move the control switch to the "OFF" position. Clear any ice from BC.
- 2) Check that BC is closed and the 115VAC 10A fuse is good.

a) Sequence and Component Diagnosis

- 3) **Power On:** Turn on the power supply, then move the control switch to the "ICE" position. A 5-sec. delay occurs. CB red "POWER" LED and green "BIN CLS" LED turn on. If orange "BIN CLS" LED is on (indicating a full bin), check BC. Move ice away from BC actuator paddle. If orange "BIN CLS" LED stays on, see "II.E. Bin Control Check and Cleaning".

Note: • CB red "POWER" LED remains on unless the 10.5VAC power supply is interrupted (K2 connector).

- Check CB using the steps in "II.D. Control Board Check."

- a) **Power On Diagnosis:** If CB red "POWER" LED is off, confirm 10A fuse is good. Check for 115VAC at control switch #2 (BR) to neutral (W) then at control switch #1 (P) to neutral (W). If 115VAC is present on #2 (BR) and not on #1 (P), replace control switch. If 115VAC is present on control switch #1 (P), check for 115VAC at HPS (P) to neutral (W) then HPS (BK) to neutral (W). If 115VAC is present at HPS (P) and not at HPS (BK), HPS is open. See HPS Diagnosis below. If 115VAC is present at HPS (BK), check for 10.5VAC at CB K2 #1 red wire to CB K2 #2 red wire. If 10.5VAC is not present, check that the cleaning valve interlock switch is closed and CT is good.

CT Check - Check CT continuity. If open, replace CT.

- b) **HPS Diagnosis:** Confirm condenser coil is not clogged or restricted. Let refrigeration circuit pressures equalize. If HPS does not reset and pressures are equalized, replace HPS. If pressures are not equalized, reclaim refrigerant and diagnose refrigeration circuit restriction. Check that there are no restrictions in the refrigeration circuit.

Harvest Cycle: HGV, strainer, or check valve.

Freeze Cycle: FM, FMR, TXV, HM, LLV, WRV, strainer, check valve, drier, damaged line set or fitting, and fan blade for binding.

Confirm that the location meets installation requirements. See the appliance's instruction manual for details.

- 4) **1-Min. Fill Cycle – WV LED is on.** WV energizes. After 1 min., CB checks for a closed FS. If FS is closed, the harvest cycle begins. If harvest cycle begins (Comp, HGV, FMR energized), continue to step 5a. If FS is open, WV remains energized until FS closes (low water safety protection during initial start up and at the end of each harvest). **Diagnosis:** Check that water enters the water tank. If not, check that the water supply line shut-off valve is open and screens or external filters are clear. Check for 115VAC at CB K1 #6 (O) to neutral (W). If 115VAC is not present, replace CB. If 115VAC is present, and WV does not energize, check for 115VAC at WV. If 115VAC is present, check coil continuity. If open, replace WV. If the water tank fills, but the appliance fails to start harvest (Comp energized), check for open FS. See "II.E. Float Switch Check and Cleaning." If FS is closed and CB fails to start the harvest cycle after 1 min., replace CB.

5a) **Initial Harvest Cycle – Comp, WV, and FM/HGV LEDs are on.** WV continues. Comp and HGV energize. CB monitors the warming of the evaporator via the thermistor located on the suction line. When the thermistor reaches 48°F (9°C), CB reads 3.9 kΩ from the thermistor and turns harvest termination over to the harvest timer (S4 dip switch 1 & 2 and S5 dip switch 4). WV is energized during harvest for a maximum of 6 min. or the length of harvest minus HPT setting (S4 dip switch 6), whichever is shorter. See step 5b below.

- a) **Comp Diagnosis:** Check that evaporator is warming. If not, confirm that Comp energizes. If not, check for 115VAC at CB K1 #1 (V) or #9 (V) to neutral (W). If 115VAC is not present, check for 115VAC at CB K1 #7 (BR) or #10 (BR) to neutral (W). If 115VAC is present at #7 (BR) or #10 (BR) and not at #1 (V) or #9 (V), replace CB. If 115VAC is present, check for 115VAC at CR or MC solenoid. If 115VAC is present, confirm contacts are closed. If not, replace CR or MC. If CR or MC contacts are closed, check Comp external overload, Comp start and run capacitors, Comp start relay, and Comp motor winding.
- b) **HGV Diagnosis:** If Comp is energized and evaporator is not warming, check that HGV energizes and opens. Check for 115VAC at CB K1 #2 (P) to neutral (W). If 115VAC is not present and FM/HGV LED is on, replace CB. If 115VAC is present, check for 115VAC at HGV coil and check HGV coil continuity. Replace as needed.
- c) **LLV Diagnosis:** Confirm that LLV is de-energized and closed (not bypassing). If energized, replace CB. If de-energized and bypassing, replace LLV.
- d) **WRV Diagnosis:** Confirm WRV is not leaking by. If WRV is leaking by, confirm HGV is open and LLV is closed. Next, check for proper refrigerant pressures. If refrigerant pressures are correct, adjust or replace WRV. See "IV.C. Water Regulating Valve Adjustment (water-cooled models)."

5b) Harvest Pump Time (Harvest Assist) – Comp, PM, and WV/HGV LEDs are on.

When the thermistor reaches 48°F (9°C), CB reads 3.9 kΩ from the thermistor and turns harvest termination over to the harvest timer (S4 dip switch 1 & 2 and S5 dip switch 4). When WV de-energizes, WV LED turns off, and PM LED turns on. PM is energized. Comp, FM, FMR, HGV, and X10 relay (remote models only) continue.

Diagnosis: Place a thermometer on the suction line next to the thermistor. Has it warmed to 48°F (9°C) or warmer? Confirm thermistor status. See "II.F. Thermistor Check." If the thermistor reading is in proper range, dip switch 7 is on, PM LED is on, and PM has not energized before harvest terminates, check for 115VAC at CB K1 #4 (R). If 115VAC is not present, replace CB. If 115VAC is present, PM LED is on, and PM has not energized before harvest terminates, check PM capacitor and motor winding continuity. Replace PM capacitor and/or PM if needed. If WV continues, check for 115VAC at CB K1 #6 (O). If 115VAC is present, and WV LED is off, replace CB. If WV is leaking by, replace WV.

5c) Initial Harvest Cycle Termination Diagnosis: When the thermistor reaches 48°F (9°C), CB reads 3.9 kΩ from the thermistor and turns harvest termination over to the harvest timer (S4 dip switch 1 & 2 and S5 dip switch 4). Check discharge line temperature. For a thermistor check, see "II.F. Thermistor Check." If 1-min. fill cycle starts after harvest timer terminates, check that FS is clean and operating properly, see "II.E. Float Switch Check and Cleaning." If FS is closed, CB proceeds to the next cycle. If not, replace CB.

Note: The minimum total time allowed by CB for a complete harvest cycle is based on S5 dip switch 4. Maximum harvest time allowed is 20 min.

NOTICE! S4 dip switch 7 must remain on. Otherwise, PM will not energize during the last seconds of harvest.

6) Freeze Cycle – Comp and PM LEDs are on. Comp, FM, FMR, and PM continue. FM and LLV energize. HGV and X10 relay (remote models only) de-energize. Appliance is held in freeze by a 5-min. short cycle protection timer. After 5-min. short cycle protection timer terminates and FS opens, freeze cycle terminates.

Note: PM power supply switches from CB K1 #5 (DBU) in harvest to K1 #4 (R) in freeze.

Anti-Slush: When anti-slush is enabled (S5 dip switch 5 "ON"), PM de-energizes when thermistor reaches 36°F (2.2°C) (5.8kΩ) for 10 sec. then, energizes for the remainder of the freeze cycle.

a) Freeze Cycle Diagnosis: Confirm Comp, FM, FMR, and PM continue. Confirm that FM and LLV energize. Confirm WRV opens. Next, confirm HGV and X10 relay (remote models only) de-energize. During the first 5 min. of freeze, confirm evaporator is cooling. If not, confirm WV de-energized (not leaking by), HGV de-energized (not bypassing), LLV and FM energize, TXV and HM operate correctly, WRV opens, Comp is efficient, and refrigerant charge is correct. See "VIII.A. Specification and Performance Data."

- b) **Comp, and FMR Diagnosis:** If Comp, FM, and FMR de-energize once freeze begins, check that appliance has not shut off on HPS ("POWER" LED off). If so, check "3)b HPS Diagnosis" above. If "POWER" LED is on, check for 115VAC at CB K1 #1 (V) or #9 (V) to neutral (W). If 115VAC is not present and Comp LED is on, replace CB.
Comp: If 115VAC is present, check for 115VAC at CR or MC coil. If 115VAC is present, check CR or MC coil and contact continuity. Replace as needed. If CR or MC is okay, check Comp start relay and start and run capacitors. Next, check Comp motor winding continuity. If Comp is energized but evaporator is not cooling, check for an inefficient Comp. See "VIII.A. Specification and Performance Data."
FMR: If Comp is energized but FMR is not, check for 115VAC at the FMR junction box. If 115VAC is not present, check icemaker wiring connections. If 115VAC is present, check for voltage at condenser unit. If 115VAC is not present, check field wiring connections. If 115VAC is present, check FMR capacitor, motor winding, and fan blade for binding.
- c) **WV and HGV Diagnosis:**
WV Diagnosis: If WV LED is on and WV is energized, check for 115VAC at CB K1 #6 (O) to neutral (W). If 115VAC is present after PM energizes in harvest cycle, replace CB. If 115VAC is not present, replace WV (bypassing).
HGV Diagnosis: If HGV did not de-energize at the end of harvest, check for 115VAC at CB K1 #2 (P) to neutral (W). If 115VAC is present at CB K1 #2 (P) and FM/HGV LED is off, replace CB. If 115VAC is not present at CB K1 #2 (P), replace HGV (bypassing).
- d) **PM Diagnosis:** Confirm water is flowing over evaporator from PM and not WV and PM LED is on. If PM de-energizes once freeze begins, check for 115VAC at CB K1 #4 (R) to neutral (W). If 115VAC is not present and PM LED is on, replace CB. If 115VAC is present and PM is de-energized, check PM capacitor and motor winding continuity. Replace PM capacitor and/or PM if needed.
- e) **FM and LLV Diagnosis:** If FM or LLV does not energize, check for 115VAC at CB K1 #3 (BK) to neutral (W). If 115VAC is not present and FM/HGV LED is off, check for 115VAC at CB K1 #1 (V). If Comp LED is on and 115VAC is present at #1 (V) and not at #3 (BK), replace CB. If 115VAC is present at #3 (BK) and FM/HGV LED is on: For FM, check capacitor, motor winding, and blade for binding. For LLV, check coil voltage and continuity.
Note: FM is OFF when FM/HGV LED is on.
- f) **Refrigerant Pressures, HM, and TXV Diagnosis:** If evaporator is still not cooling, check refrigerant pressures. See "VIII.A. Specification and Performance Data." Next, check HM operation. If refrigeration pressures are above HM setpoint and HM is bypassing, replace HM. Check TXV for proper operation. Remove TXV bulb and hold it in your hand, refrigerant low-side pressure should rise, place TXV bulb in ice water, refrigerant low-side pressure should drop. A 10 to 15 pound pressure swing between warm and cold conditions indicate a good TXV. If a 10 to 15 pound swing is not present, replace TXV.

- g) **WRV Diagnosis:** WRV is factory set and generally no adjustment is required. If WRV fails to open in freeze, check for proper refrigerant pressures. See "VIII.A. Specification and Performance Data." If refrigerant pressures are correct and WRV does not open, adjust or replace as needed. See "IV.C. Water Regulating Valve Adjustment (water-cooled models)."
- h) **Freeze Termination Diagnosis:** After 5 min. in freeze, disconnect CB K5 FS connector. 15 sec. later appliance should switch out of the freeze cycle (15 second delay after FS opens before terminating the freeze cycle). If appliance remains in freeze longer than 15 sec. after FS removed, replace CB. If appliance switches with FS removed but would previously not switch out of freeze with FS connected (long freeze - 3 beep alarm), see "II.E. Float Switch Check and Cleaning."

Note: Normal freeze cycle will last 20 to 40 min. depending on model and conditions. Cycle times and pressures should follow performance data provided in this manual. See "VIII.A. Specification and Performance Data."

- i) **Short Freeze Cycle Diagnosis:** Confirm water tank fills and overflows during fill and harvest cycles. If not, check water supply filters, shut-off valve, WV screen. If water tank empties before 5 min. timer terminates and freeze cycle is short, check that CV is not leaking by (water flowing down the potable drain). If CV is leaking by, remove and clean CV, replace rubber seat and spring if necessary. If water tank is full, see "II.E. Float Switch Check and Cleaning." for erratic FS.

7) **Pump-Out Cycle – Comp, PM, FM/HGV, and DV LEDs are on (10/20 second pump-out).** Timing of the first pump-out is determined by S4 dip switch 5. See the table below.

2A9678-xx Control Board Settings		
S4 Dip Switch Setting	Pump-Out Frequency	1st Pump-Out
No. 5		
OFF	Every 10 cycles	After 11th freeze cycle
ON	Every cycle	After 2nd freeze cycle

Comp, FM, and FMR continue, HGV energizes. If S4 dip switch 3 & 4 are set to 3 off and 4 on, WV LED turns on and WV energizes, energizing X10 relay (remote models only). **NOTICE! S4 dip switch 3 & 4 must not be set to 3 off and 4 on. Otherwise, PM will rotate in freeze cycle direction instead of pump-out direction.** FM and LLV de-energize. PM stops for 2 sec., then PM (LED on) and DV (LED on) energize for 10/20 sec. depending on pump-out timer (S4 dip switch 3 & 4) setting. When the pump-out timer terminates, pump-out is complete. The pump-out frequency control (S4 dip switch 5) is factory set, and generally no adjustment is required. However, the pump-out frequency control can be set to have a pump-out occur every 10 cycles or every cycle. For details, see "III.C.4. Pump-Out Frequency Control (S4 dip switch 5)."

Pump-Out Diagnosis: In the freeze cycle before pump-out (see table above), after 5 min. of freeze disconnect CB black K5 connector (FS connector). Check that PM stops and re-starts. Next, check that PM and DV energized (water flowing down the drain through DV). If PM does not stop and re-start, check that CB Comp, PM, and DV LEDs are on. If not, replace CB. If Comp, PM, and DV LEDs are on and PM does not energize, check for 115VAC at CB K1 #4 (R) to neutral (W). If 115VAC is not present, replace CB. If 115VAC is present, check for PM windings and impeller for binding. If PM is energized and PM LED is on, confirm DV is energized. If DV is not energized, check for 115VAC at CB K1 #5 (W/BU). If 115VAC is not present and DV LED is on, replace CB. If 115VAC is present, check DV solenoid continuity. Replace as needed. If DV is energized and open, check that the drain line is not clogged.

Confirm FM and LLV de-energize. If FM or LLV are energized with Comp, PM, and DV LEDs on, replace CB.

8) **Normal Harvest Cycle** – Same as the initial harvest cycle. Return to step 5a) above.

Note: Appliance continues to cycle until BC is satisfied, power is switched off. The appliance always restarts at the 1-min. fill cycle.

b) Shutdown Diagnosis

1) See "II.E. Bin Control Check and Cleaning."

C. Freeze Up Detection Cycle (Control Board 2A9678-02)

Auxiliary Code: P-4 and Later

The freeze-up detection cycle (FUD) is enabled when the CB S5 DIP Switch 4 is in the "OFF" position. FUD monitoring starts in the 2nd freeze cycle after startup, 2nd freeze cycle after a bin control restart, 1st freeze cycle after a Modified Harvest, and every freeze cycle thereafter until the FUD cycle resets. The CB monitors the thermistor temperature and the time to reach 36°F (2°C) during the freeze cycle, to evaluate for any abnormal freeze cycle issues. When the FUD cycle is activated, the CB red "POWER" LED starts blinking and continues to blink throughout the FUD cycle. A FUD cycle consists of 1 modified harvest, 6 normal freeze cycles, and 5 normal harvest cycles. The FUD cycle terminates after achieving passing results at CB checks 1 and 2 on the 6th consecutive freeze cycle without a FUD cycle initiation. The red CB "POWER" LED returns to a solid state.

Note: If "POWER" LED is blinking and a manual reset is required, see "II.C.5)b) Manual Reset:" to reset FUD cycle.

1) **FUD Cycle Initiation:**

A FUD modified harvest cycle is initiated by one of the CB checks below:

- a) **Check 1:** Temperature/Time Initiation - Occurs in the 2nd freeze cycle after startup, the 2nd freeze cycle after a bin control restart, or the 1st freeze cycle after a Modified Harvest cycle and every freeze cycle thereafter. Thermistor reaches 36°F (2°C) within the first 30 sec. of freeze cycle initiation, FUD cycle initiates.
- b) **Check 2:** Temperature Time Initiation – Occurs in the 2nd freeze cycle after startup, the 2nd freeze cycle after a bin control restart, or the 3rd freeze cycle after a Modified Harvest cycle and every freeze cycle thereafter. Thermistor reaches 36°F (2°C) within the 31 to 90 seconds of freeze cycle initiation. CB then compares the time differential between the previous time from freeze cycle initiation to 36°F (2°C) and the current from freeze cycle initiation to 36°F (2°C). If the time differential is equal to or greater 40 sec. a FUD cycle is initiated.

Check 2 Initiation Example: If the previous time from freeze cycle initiation to 36°F (2°C) was 110 seconds and the current time from freeze cycle initiation to 36°F (2°C) is 60 seconds, the time differential is 50 sec. As this is greater than 40 sec., a FUD cycle is initiated.

Check 2 Non-initiation Example: If the previous time from freeze cycle initiation to 36°F (2°C) was 110 seconds and the current time from freeze cycle initiation to 36°F (2°C) is 80 seconds, the time differential is 30 sec. As this is less than the 40 sec., a FUD cycle is not initiated.

2) **FUD Cycle Modified Harvest – LEDs Comp, PM, WV, FM/HGV, are on and "POWER" LED Starts Blinking:**

A FUD modified harvest cycle is similar to a normal harvest cycle, with the following differences:

- **20-sec. PM:** PM LED on and PM energized for the first 20 seconds of the FUD cycle modified harvest. PM LED turns off and PM de-energizes after 20 sec.
- **6-min. WV:** WV LED on and WV energized for a mandatory 6-min. time frame during the FUD cycle modified harvest. WV LED turns off and WV de-energizes after 6 min.
- **100-sec. HPT:** PM LED on and PM energizes. HPT is now 100 sec. (Default is 50 sec. for normal harvest cycle). PM LED remains on and PM remains energized. HPT terminates and freeze cycle starts.

3) **FUD Cycle Freeze Cycle – LEDs Comp, FM/HGV, and PM are on and "POWER" LED Continues Blinking:**

During the 1st FUD freeze cycle, CB check 1 occurs. If 36°F (2°C) is detected within 30 sec., freeze cycle is terminated and a FUD modified harvest initiates. If the first freeze cycle CB check 1 passes, the freeze cycle continues until the FS terminates the freeze cycle (no CB check 2 during first freeze cycle after FUD modified harvest). The CB check 2 is delayed until the 2nd freeze cycle after a FUD cycle modified harvest. During the 2nd freeze cycle and every freeze cycle thereafter, both CB checks 1 and 2 occur. If either CB checks 1 or 2 fail, FUD Modified Harvest initiates.

4) **FUD Cycle Termination - "POWER" LED Stops Blinking:**

When the CB checks 1 and 2 have completed 6 consecutive freeze cycle checks with no FUD modified harvest initiation, the FUD cycle terminates. The CB red "POWER" LED resets and returns to a solid state. For Manual reset (if required), see "II.C.5.b) **Manual Reset**" to reset FUD cycle.

FUD Cycle Diagnostics:

- a) **20 sec. PM:** CB red "POWER" LED blinking. CB LEDs Comp, WV, PM, and FM/HGV are on and Comp, FM/FMR, HGV, PM, and WV energize. 20-sec. PM timer starts. Once 20-sec. PM timer terminates, PM de-energizes and PM LED turns off. Comp, FM/FMR, FM/HGV, and WV continue.
Diagnosis: Confirm water is flowing over and into the evaporator from the PM and the PM LED is on. Check for 115VAC at CB K1 #4 (R) to neutral (W). If 115VAC is not present and PM LED is on, replace CB. If 115VAC is present and PM is de-energized, check PM capacitor and motor winding continuity. Replace PM capacitor and/or PM if needed.
- b) **6-Min. WV:** CB red "POWER" LED blinking. CB LEDs Comp, WV, and FM/HGV are on and Comp, FM/FMR, HGV, and WV are energized. 6-min. WV timer starts. When the 6-min. WV timer terminates, WV de-energizes. WV LED turns off.
Diagnosis: Confirm water is flowing into the evaporator from the WV and the WV LED is on. If WV LED stays on longer than 6 min. and WV is energized, check for 115VAC at CB K1 #6 (O) to neutral (W). If 115VAC is present, replace CB. If 115VAC is not present, replace WV (bypassing).

c) **Harvest Pump Time (Harvest Assist):** CB red "POWER" LED blinking. CB LEDs Comp, PM, and FM/HGV are on and Comp, FM/FMR, HGV, and PM remain energized. When the thermistor reaches 48°F (9°C), CB reads 3.9 kΩ from the thermistor and turns harvest termination over to the harvest pump timer. When WV de-energizes, WV LED turns off and PM LED turns on. PM energizes. Comp, FMR, and HGV continue.

Diagnosis: Place a thermometer on the suction line next to the thermistor. Has it warmed to 48°F (9°C) or warmer? Confirm thermistor status. See "II.G. Thermistor Check." If the thermistor reading is in proper range, dip switch 7 is on, PM LED is on, and PM has not energized before harvest terminates, check for 115VAC at CB K1 #4 (R). If 115VAC is not present, replace CB. If 115VAC is present, PM LED is on, and PM has not energized before harvest terminates, check PM capacitor and motor winding continuity. Replace PM capacitor and/or PM if needed. If WV continues, check for 115VAC at CB K1 #6 (O). If 115VAC is present, and WV LED is off, replace CB.

5) **FUD Modified Harvest Cycle Reset ("POWER" LED Stops Blinking):**

- a) **Freeze Cycle Reset:** The CB red "POWER" LED will continue to blink after a power cycle. The FUD cycle terminates after achieving passing results at CB checks 1 and 2 on the 6th consecutive freeze cycle without a FUD cycle initiation.
- b) **Manual Reset:** Switch CB S5 DIP switch #4 to the "ON" position, then back to the "OFF" position. CB resets to normal operating mode and CB red "POWER" LED stops blinking.

Legend: **BC**—bin control; **CB**—control board; **Comp**—compressor; **CR**—compressor relay; **CT**—control transformer; **CV**—check valve; **FM**—fan motor; **FMR**—fan motor remote; **FS**—float switch; **FUD**—freeze-up detection; **HGV**—hot gas valve; **HM**—headmaster (C.P.R.); **HPS**—high-pressure switch; **LLV**—liquid line valve; **MT**—main transformer; **PM**—pump motor; **TXV**—thermostatic expansion valve; **WRV**—water regulating valve; **WV**—inlet water valve

D. Control Board Check

1. Auxiliary Code: P-2 and Earlier (KM-901M_J(Z)/3, KM-1100M_J(Z))

Auxiliary Code: N-3 and Earlier (KM-1340M_J(Z)/3, KM-1601MRJ(Z)/3)

Before replacing CB that does not show a visible defect and that you suspect is bad, always conduct the following check procedure. This procedure will help you verify your diagnosis.

Alarm Reset: If CB is in alarm (beeping), press the "ALARM RESET" button on CB while CB is beeping. **WARNING! Risk of electric shock. Care should be taken not to touch live terminals.** Once reset, the icemaker starts at the 1-minute fill cycle. For audible alarm information, see "III.B. LED Lights and Audible Alarm Safeties."

- 1) Check the dip switch settings to assure that S4 dip switch 3, 4, 7, 8, 9, 10 and S5 dip switch 1 through 5 ("G" CB) are in the factory default position. S4 dip switch 1, 2, 5, 6 are cleaning adjustments and the settings are flexible. For factory default settings, see "III.C.1. Default Dip Switch Settings."
- 2) Move the control switch to the "ICE" position. If the red "POWER OK" LED is on, control voltage is good, continue to step 3. If the "POWER OK" LED is off, check CT secondary circuit. CT output is 10.5VAC at 115VAC primary input. If the secondary circuit has proper voltage and the red LED is off, replace CB.

If the secondary circuit does not have proper voltage, check CT primary circuit. Check for 115VAC at CB K1 connector pin #10 (BR) to neutral (W) for 115VAC. Always choose a white (W) neutral wire to establish a good neutral connection when checking voltages. For additional checks, see "II.I.1. No Ice Production."

- 3) The "OUTPUT TEST" button provides a relay sequence test. Make sure the control switch is in the "ICE" position, then press the "OUTPUT TEST" button. For the correct lighting sequence, see the table below. Note that the order of the LEDs from the outer edge of the control board is 1, 4, 3, 2. Components (e.g., compressor) cycle during the test.

Control Board	Correct LED Lighting Sequence
2A7664-xx	1, 4, 3, 2

Following the test, the icemaker begins operation at the 1-minute fill cycle for both "E" and "G" control boards. If the LEDs do not light as described above, replace CB.

- 4) To verify voltage output from CB to the components, slide the CB K1 connector out far enough to allow multimeter lead contact. With the icemaker in the cycle to be tested, check output voltage from the corresponding pin on CB K1 connector to a neutral (W wire). If output voltage is not found and the appropriate LED is on, replace CB.

Legend: **CB**—control board; **CT**—control transformer

2. Auxiliary Code: P-3 and Later (KM-901M_J(Z)/3, KM-1100M_J(Z))

Auxiliary Code: P-0 and Later (KM-1340M_J(Z)/3, KM-1601MRJZ/3)

Before replacing CB that does not show a visible defect and that you suspect is bad, always conduct the following check procedure. This procedure will help you verify your diagnosis.

Alarm Reset: If CB is in alarm (beeping), press the "ALARM RESET" button on CB while CB is beeping. **WARNING! Risk of electric shock. Care should be taken not to touch live terminals.** Once reset, the icemaker starts at the 1-min. fill cycle. For audible alarm information, see "III.B. LED Lights and Audible Alarm Safeties."

- 1) Check the dip switch settings to assure that S4 dip switch 3, 4, 7, 8, 9, 10 and S5 dip switch 1 through 5 are in the factory default position. S4 dip switch 1, 2, 5, and 6 are cleaning adjustments and the settings are flexible. For factory default settings, see "III.C.1b. Default Dip Switch Settings."
- 2) Move the control switch to the "ON" position and the mode switch to the "ICE" position. If the red CB "POWER" LED is on, control voltage is good, continue to step 3). If CB "POWER" LED is off, check CT secondary circuit. CT output is 10.5VAC at 115VAC primary input. If the secondary circuit has proper voltage and the red LED is off, replace CB.

If the secondary circuit does not have proper voltage, check CT primary circuit. Check for 115VAC at CB K1 connector pin #10 (BK) to neutral (W) for 115VAC. Always choose a white (W) neutral wire to establish a good neutral connection when checking voltages. For additional checks, see "II.I.1. No Ice Production."

- 3) The "OUTPUT TEST" button provides a relay sequence test. Make sure the control switch is in the "ON" position and the mode switch is in the "ICE" position, then press the "OUTPUT TEST" button. For the correct lighting sequence, see the table below. Note that the order of the LEDs from the outer edge of the control board is Comp, CV, WV, DV, PM, FM/HGV. Components cycle during the test. See Fig. 1. Following the output test cycle, the icemaker begins normal icemaking operation at the 1-min. fill cycle. If the LEDs do not light as described above, replace CB.

IMPORTANT! Do not press the "OUTPUT TEST" button while CB is in alarm.

See Fig. 1. Pressing the "OUTPUT TEST" button while CB is in alarm initiates an output test and locks out the "ALARM RESET" button. To reset the "ALARM RESET" button, turn the power power off and back on.

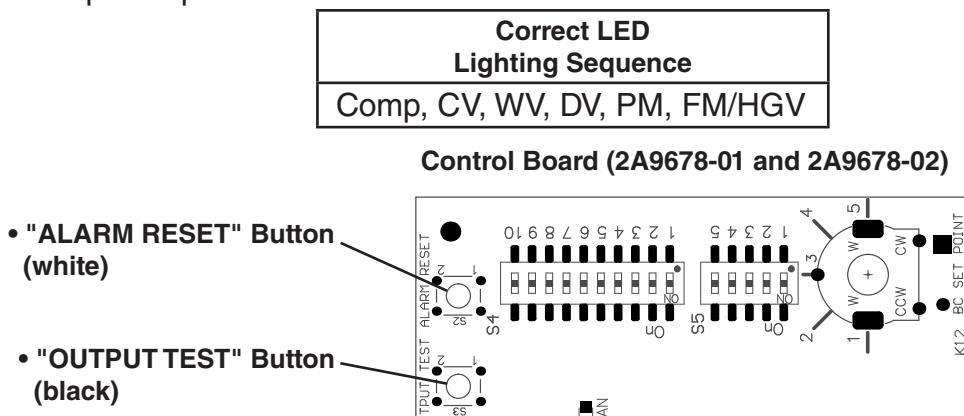

Fig. 1

- 4) To verify voltage output from CB to the components, slide the CB K1 connector out far enough to allow multimeter lead contact. With the icemaker in the cycle to be tested, check output voltage from the corresponding pin on CB K1 connector to a neutral (W) wire. If output voltage is not found and the appropriate LED is on, replace CB.
- 5) **5VDC Output Checks:** When checking 5VDC control voltage, always place the red positive test lead from the multimeter to the CB white K11 pin closest to the CB white K13 connector. See Fig. 2a. Then place the black negative test lead from the multimeter to the corresponding pin to complete the 5VDC check.
- 6) Check CB control connectors K3 (Evaporator Thermistor) and K5 (Float Switch) for correct VDC per table below. See Fig. 2b.

Legend: **CB**—control board; **CT**—control transformer

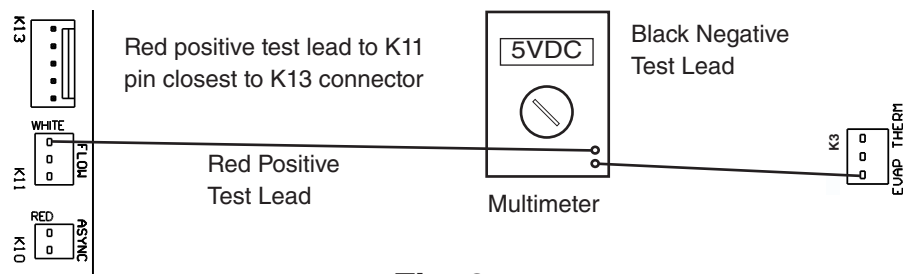
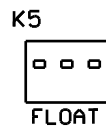

Fig. 2a

Control Board (2A9678-01 and 2A9678-02)

K5 Float Switch	
Pin #	VDC
#1 to #2	1.2VDC
#1 to #3	2VDC
#2 to #3	1.2VDC

K3 Thermistor	
Pin #	VDC
#1 to #2	5VDC
#1 to #3	5VDC
#2 to #3	0VDC



CB

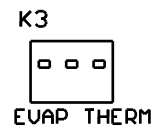

Fig. 2b

E. Bin Control Check and Cleaning

1. Thermostatic Bin Control Check

BC shuts down the icemaker within 10 sec. when ice contacts the thermostatic bulb, regardless of the cycle at activation.

NOTICE
When the ambient temperature is below 45°F (7°C), BC opens and shuts down the appliance even if the ice storage bin is empty. When BC is set in the prohibited range, the appliance operates continuously even if the ice storage bin is filled with ice. Setting in the prohibited range may result in severe damage to the appliance.

BC is factory set, and generally no adjustment is required. However, adjustment may be needed in some conditions, particularly at higher altitude locations.

Note: A jumper (4A4883G01) must be placed on CB red K4 connector. Otherwise, CB yellow "BC OPEN" LED is on and appliance will not start.

To check BC, follow the steps below.

- 1) Turn off the power supply.
- 2) Remove the front panel, then move the control switch to the "OFF" position.
- 3) Remove the control box cover and base cover, then clear any ice away from BC bulb.
- 4) Disconnect BC wires from BC switch.
- 5) Hold your hand around the bulb to warm it up.
- 6) Check for continuity across BC switch. If closed, continue to step 6. If open, adjust or replace BC.
- 7) With the multimeter test leads still in place, hold ice on BC bulb to lower the temperature. Within 10 sec., BC switch should open. If it remains closed, adjust or replace BC.

Legend: **BC**—thermostatic bin control

2. Mechanical Bin Control Check

This appliance uses a lever-actuated proximity switch to control the ice level in the storage bin. No adjustment is required.

To check BC, follow the steps below.

- 1) Turn off the power supply.
- 2) Remove the front panel, then move the control switch to the "OFF" position.
- 3) Remove the control box cover, then clear any ice away from BC.
- 4) Check that BC is closed and the 115VAC 10A fuse is good.
- 5) Check BC wire harness connections. See Fig. 3.
- 6) Disconnect BC connector from CB K4 connector.
- 7) Check for continuity across the wires of BC connector. When the actuator paddle is not engaged, BC switch is closed. If open, check that the wire harness connector is properly connected and that the actuator paddle is not sticking. Clean if necessary. See "II.E.2.b) Bin Control Cleaning." If BC switch still reads open, replace BC.
- 8) Press and hold the actuator paddle; check for continuity across the wires of BC connector. When the actuator paddle is engaged, BC switch is open. If closed, check that the actuator paddle is not restricted. Clean if necessary. See "II.D.2.b) Mechanical Bin Control Cleaning." If BC switch still reads closed, replace BC.
- 9) Reconnect BC connector to CB K4 connector, then move the control switch to the "ICE" position. Turn on the power supply.
- 10) Check that CB green "BC CLOSED" LED is on.
- 11) Allow the icemaker to cycle on. Press and hold the actuator paddle. CB yellow "BC OPEN" LED should turn on and the icemaker should shut down according to the chart below. If it does not, replace CB.

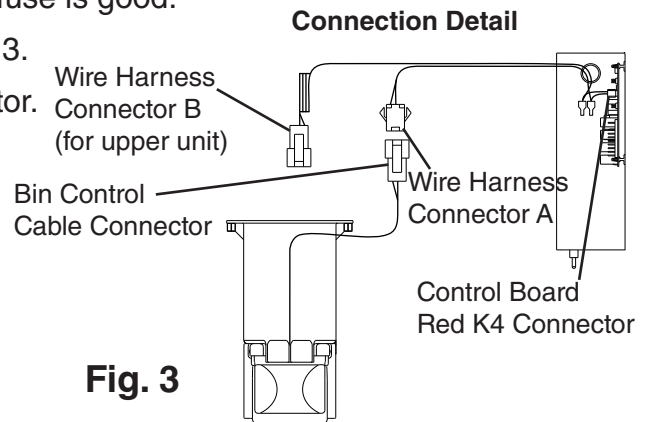

Fig. 3

Cycle at Mechanical Bin Control Activation	Shutdown
Fill Cycle	15 sec. after activation.
Harvest Cycle	At the end of the harvest cycle, or up to 15 sec. into the freeze cycle if activated at the end of the harvest cycle.
Freeze Cycle	15 sec. after activation if activated at least 15 sec. before the 5-min. short cycle protection timer terminates. Otherwise, at the end of the next harvest cycle.

Legend: **BC**—bin control; **CB**—control board

3. Mechanical Bin Control Cleaning

Scale may build up on BC. Scale can cause the actuator paddle and magnet to stick. In this case, BC should be cleaned.

⚠ WARNING

CHOKING HAZARD: Ensure all components, fasteners, and thumbscrews are securely in place after the icemaker is serviced. Make sure that none have fallen into the dispense unit/ice storage bin.

- 1) Turn off the power supply.
- 2) Remove the front panel, then move the control switch to the "OFF" position.
- 3) Clear any ice away from BC.
- 4) Disconnect BC connector from CB K4 connector, then remove BC from the icemaker.
- 5) Remove the actuator paddle from the switch mount. See Fig. 4.
- 6) Wipe down BC with a mixture of 1 part of Hoshizaki "Scale Away" and 25 parts of warm water. Rinse the parts thoroughly with clean water.
- 7) Reassemble BC and replace it in its correct position.
Note: If the magnet was removed for cleaning, be sure to replace it in its correct position.
- 8) Reconnect BC connector to CB K4 connector, then move the control switch to the "ICE" position.
- 9) Replace the control box cover in its correct position.
- 10) Turn on the power supply to start the automatic icemaking process.
- 11) Replace the front panel in its correct position.

Legend: **BC**—bin control

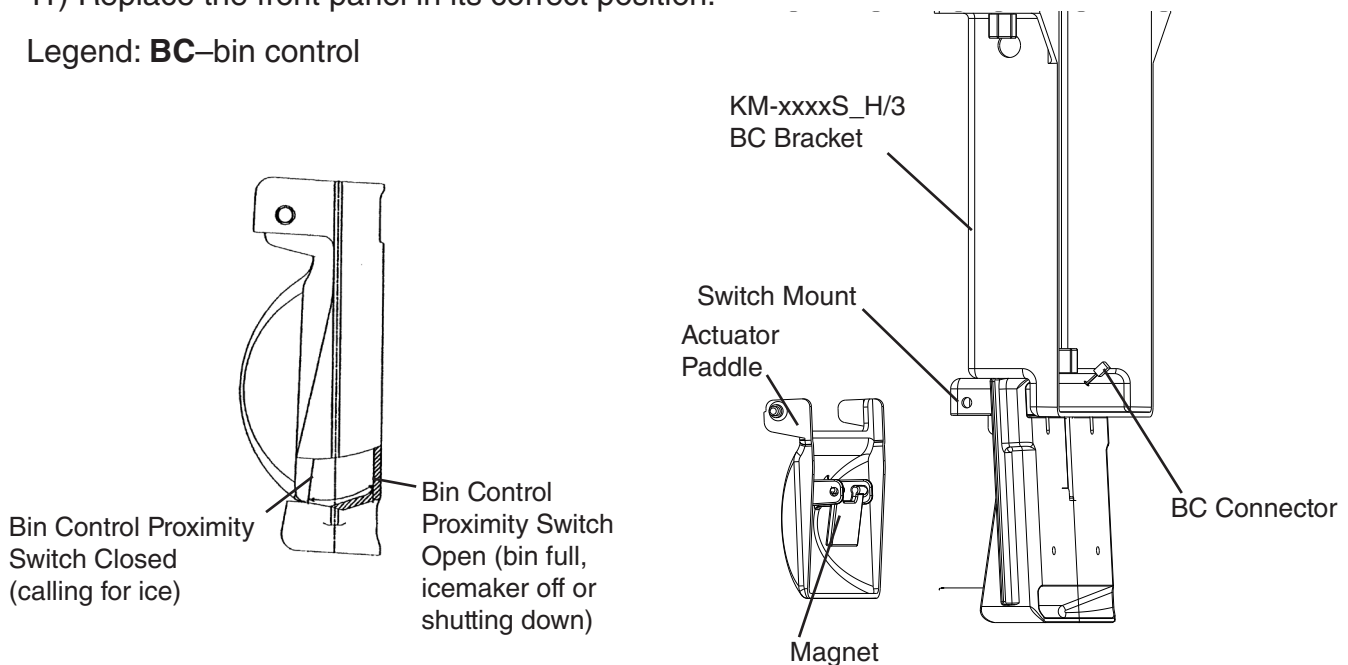

Fig. 4

4. Ultrasonic Bin Control Check

⚠ WARNING

- All parts are factory-adjusted. Improper adjustments may adversely affect safety, performance, component life, and warranty coverage.
- In Hoshizaki DB and DM dispenser applications, the bin control controller setting must be adjusted to 2. For Coca-Cola Freestyle® Dispenser and other dispenser applications, the bin control controller setting must be adjusted to 3. Increasing the ice level on any dispenser application could lead to icemaker movement, water leakage, or ice overflow.
- Be sure control switch is in "OFF" position and components (fan blade) have stopped moving before attempting to remove or replace the bin control sensor.

NOTICE

- Do not block the bin control lens with top kits or the icemaker will not operate properly.
- Failure to properly adjust the bin control setting could result in water leakage, ice backup, and icemaker damage.

Before replacing UBC sensor and CB that does not show a visible defect and you suspect is bad, always conduct the following check procedure. This procedure will help you verify your diagnosis. Note: It is strongly advised to keep a known "good" UBC sensor on your truck, for troubleshooting assistance.

The ultrasonic bin control is factory set for use on Hoshizaki America standard ice storage bins. If mounted on a dispenser application or if a change to the ice level in an ice storage bin application is desired, see "II.E.5. Ultrasonic Bin Control Adjustment."

- 1) Remove the front panel. Move the control switch to the "OFF" position, then remove the top panel, right side panel, and control box cover. See Fig. 5.
- 2) Clear ice away from UBC area and confirm that the UBC lens is clean.
- 3) Place the mode switch in the "ICE" position, then move the control switch to the "ON" position. See Fig. 5.

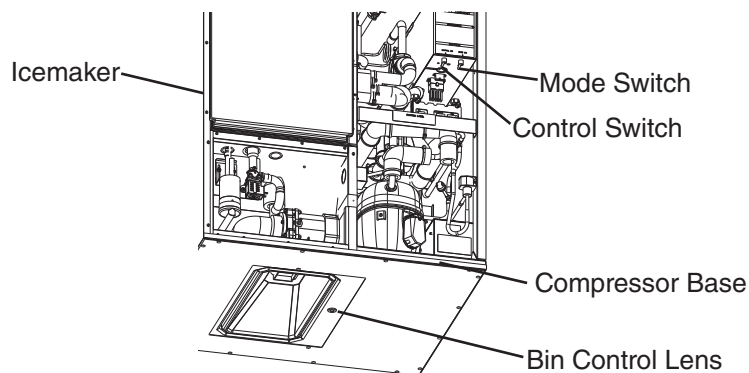

Fig. 5

- 4) **Bin Empty Diagnosis:** As water begins to fill the water tank (1-min. fill), place an object 5" to 7" (127 to 178 mm) away from the UBC lens. CB 5-sec. delay timer starts. "BIN CLS" LED turns on. CB 5-sec. delay timer terminates, CB 15-sec. delay timer starts. CB 15-sec. delay timer terminates and the icemaker shuts down. Remove the object from the UBC lens. CB 30-sec. delay timer starts. CB 30-sec. delay timer terminates, CB "BIN CLS" LED turns off, and the icemaker restarts. Note: In some cases, removing the UBC sensor and rotating the UBC lens up and down, provides better access when troubleshooting.

Cycle at Bin Control Activation	Control Board Shutdown
Fill Cycle	15 sec. after activation.
Harvest Cycle	If engaged 15 sec. or longer, at the end of harvest cycle.
Freeze Cycle	15 sec. after activation if activated at least 15 sec. before the 5-min. short cycle protection timer terminates. Otherwise, at the end of the next harvest cycle.

Ice Level in Bin	"BIN CLS" LED
Empty	OFF
Full	ON

- 5) **Bin Full Diagnosis:** Place an object 5" to 7" (127 to 178 mm) away from the UBC lens. If shut down cycle does not start, confirm CB "BIN CLS" LED turns on. If not, confirm object placement. If object placement is correct, replace UBC sensor and CB. If CB orange "BIN CLS" LED turns on and shut down cycle does not start, see "II.B.1.4) 1-min. Fill Cycle."
- Note: In some cases, removing the UBC sensor and rotating UBC lens up and down, provides better access when troubleshooting.
- 6) Once the icemaker restarts, move the control switch to the "OFF" position, then turn off the power supply.
- 7) Replace the control box cover, right side panel, and top panel in their correct position.
- 8) Move the control switch to the "ON" position. Replace the front panel in its correct position, then turn on the power supply to start the automatic icemaking process.

Legend: **UBC**—ultrasonic bin control; **CB**—control board

5. Ultrasonic Bin Control Adjustment

⚠ WARNING

- All parts are factory-adjusted. Improper adjustments may adversely affect safety, performance, component life, and warranty coverage.
- In Hoshizaki DB and DM dispenser applications, the bin control controller setting must be adjusted to 2. For Coca-Cola Freestyle® Dispenser and non-Hoshizaki dispenser applications, the bin control controller setting must be adjusted to 3. Increasing the ice level on any dispenser application could lead to icemaker movement, water leakage, or ice overflow.

NOTICE

- Do not block the bin control lens with top kits or the icemaker will not operate properly.
- Failure to properly adjust the bin control setting could result in water leakage, ice backup, and icemaker damage.

The ultrasonic bin control is factory set to 1 for use on Hoshizaki America standard ice storage bins. See the table below for adjustments to ice level.

WARNING! Do not adjust outside of these settings.

- 1) If not already removed, remove the front, top, and right side panels. Next, remove the control box cover.
- 2) Confirm ultrasonic bin control setting for proper application. See the table below for settings. See Fig. 6. for ice level reference.

Note: Bin Control setting is for distance only. For time to shutdown, see "II.A.2b. Shutdown Flow Chart".

Application	Bin Control Setting	Reference
Standard Ice Storage Bins (Factory Default)	1	See Fig. 6
Hoshizaki DB and DM Dispensers	2	
Coca-Cola Freestyle® Dispensers	3	
Non-Hoshizaki Dispensers	Measurement Required	See Fig. 7

For Standard Ice Storage Bins, Hoshizaki DB and DM Dispenser Units, and Coca-Cola Freestyle® Dispenser Units

Application	Bin Control Ice Level Settings	
	Bin Control Setting	Shutdown Distance From Bin Control Lens (Restart is 4 in. (102 mm) below shutdown distance)
Standard Ice Storage Bins	1 (Factory Default)	304 mm (12") Do not adjust dispensers to this setting.
Hoshizaki DB and DM Dispensers	2	335 mm (13")
Coca-Cola Freestyle® Dispensers	3	416 mm (16 3/8")
Optional Setting	4	522 mm (20.5")
	5	610 mm (24")

⚠ WARNING

Confirm that the final ice level location does not allow for icemaker movement, water leakage, or ice overflow.

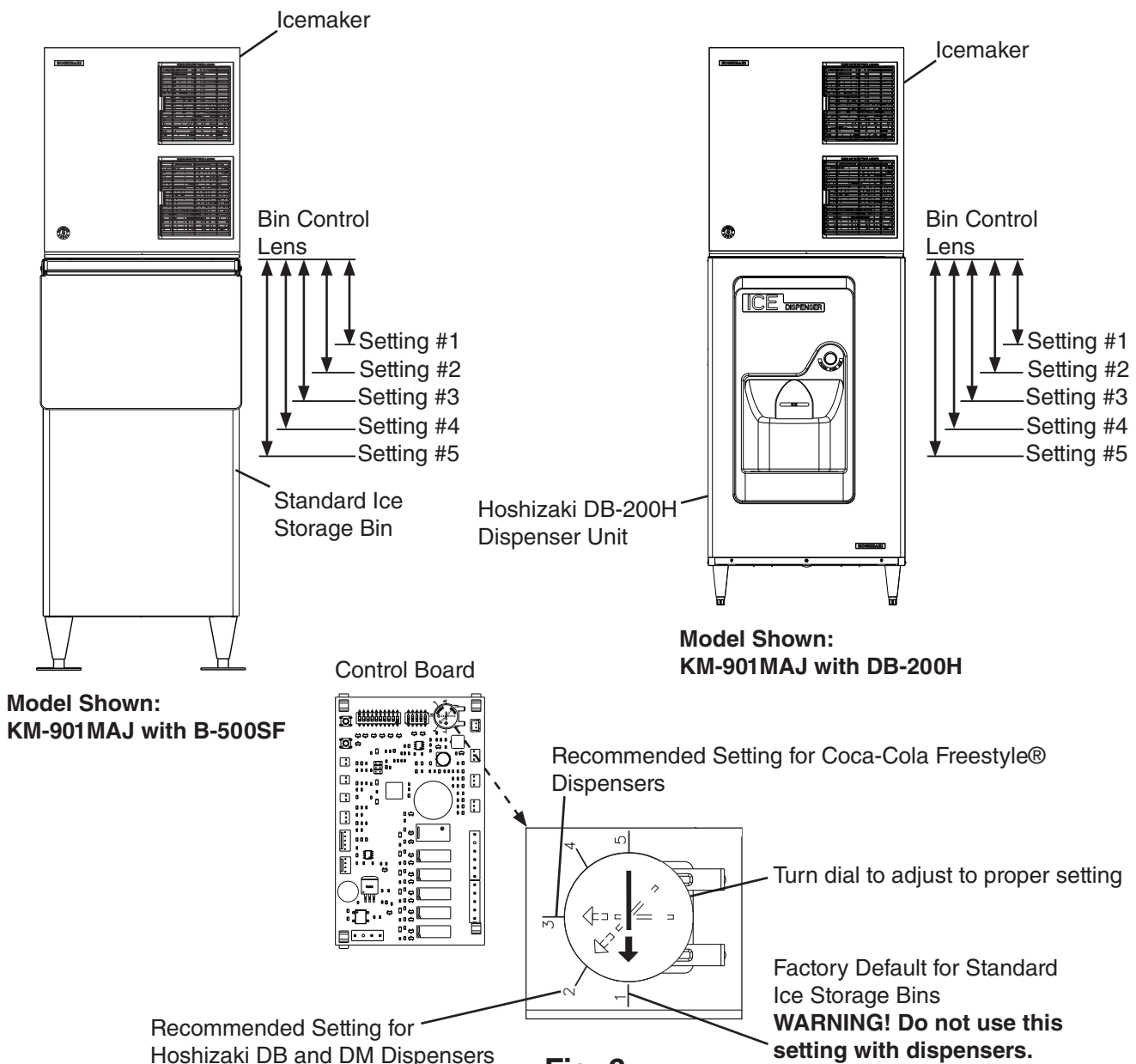

Fig. 6

For Non-Hoshizaki Dispenser Units

Bin Control Ice Level Settings	
Bin Control Setting	Shutdown Distance From Bin Control Lens (Restart is 4 in. (102 mm) below shutdown distance)
1 (Factory Default)	304 mm (12") Do not adjust dispensers to this setting.
2	335 mm (13")
3	416 mm (16 3/8")
4	522 mm (20.5")
5	610 mm (24")

⚠ WARNING

Confirm that the final ice level location does not allow for icemaker movement, water leakage, or ice overflow.

NOTICE

The ice level must be lower than the top of the dispenser unit. Also, be sure the top kit or top kit riser (if applicable) are clear from the bin control lens sensing area.

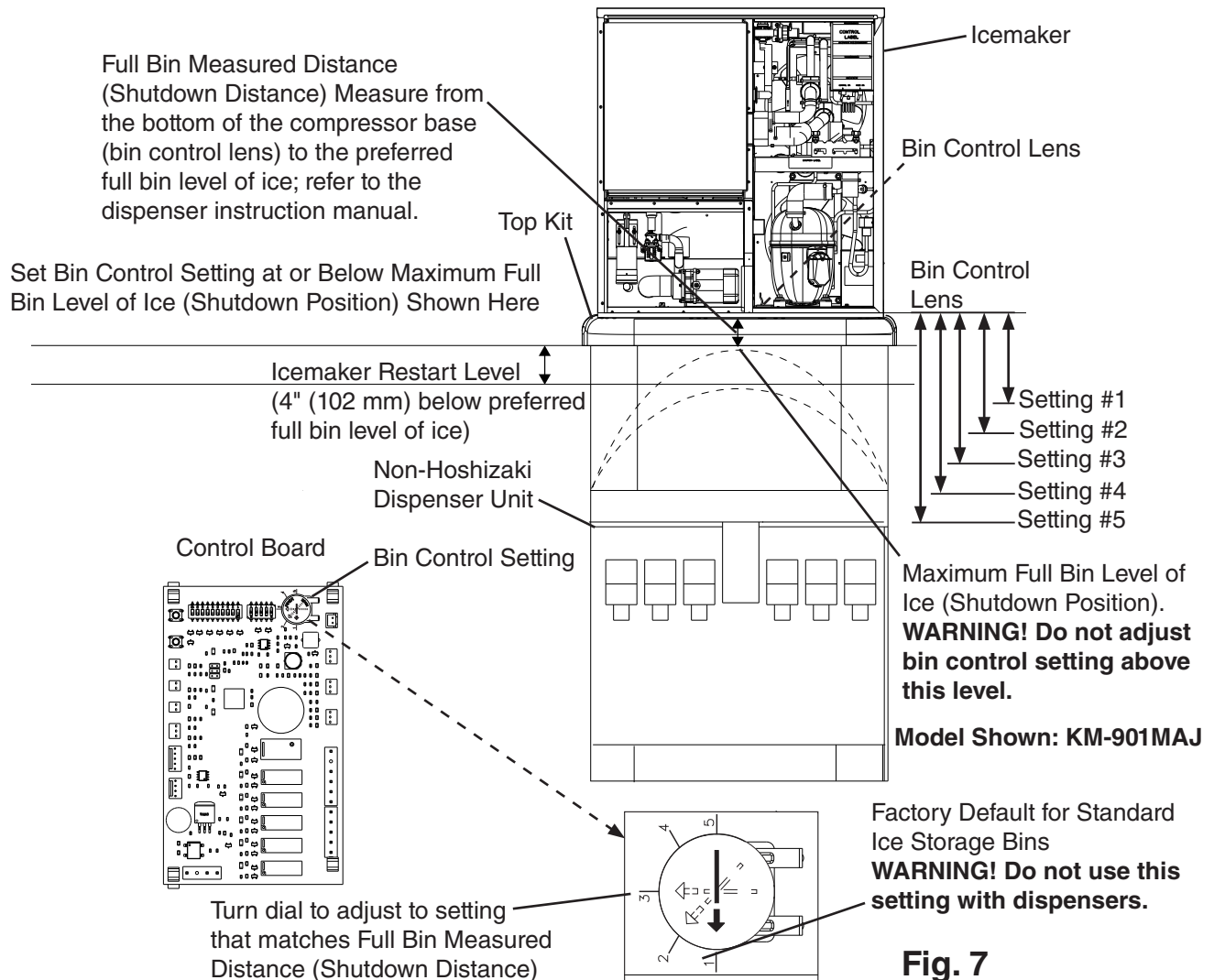

F. Float Switch Check and Cleaning

FS is used to determine that there is sufficient water in the water tank after the 1-min. fill cycle and after each harvest cycle. FS is also used to determine that the appropriate volume of water has been converted into ice before switching out of the freeze cycle. No adjustment is required.

1. Float Switch Check

To check FS, follow the steps below.

- 1) Turn off the power supply.
- 2) Remove the front panel, then move the control switch to the "OFF" position.
- 3) Drain the water tank. Remove the front insulation panel, then slide the cube guide to the right. Remove the rubber cap and sleeve covering the overflow pipe. See Fig. 8. Unscrew the overflow pipe. After the water tank has drained, reconnect the overflow pipe. Replace the rubber cap, sleeve, cube guide, and front insulation panel in their correct positions. **NOTICE! Make sure the O-ring is attached to the bottom of the overflow pipe and be careful not to cross thread the overflow pipe.**
- 4) Remove the control box cover.
- 5) Disconnect FS connector from CB K5 connector.
- 6) Check for continuity across FS leads. With the water tank empty, FS should be open. If open, continue to step 7. If closed, follow the steps in "II.F.2. Float Switch Cleaning." After cleaning FS, check it again. Replace if necessary.
- 7) Reconnect FS connector to CB K5 connector, then replace the control box cover in its correct position.
- 8) Move the control switch to the "ICE" position. Replace the front panel in its correct position, then turn on the power supply. After 1 min., the 1-min. fill cycle should end and the initial harvest cycle should begin. If the initial harvest cycle begins, FS is good and the check is complete. If the initial harvest cycle does not begin, continue to step 9.
- 9) Turn off the power supply and remove the front panel. Move the control switch to the "OFF" position.
- 10) Remove the control box cover and disconnect FS connector from CB K5 connector.
- 11) Check for continuity across FS leads. With the water tank full, FS should be closed. If FS is closed and the icemaker will not switch from the 1-min. fill cycle to the initial harvest cycle, replace CB. If FS is open, confirm that the water tank is full. If the water tank is not full, check the water supply, water filters, and inlet water valve. If the water tank is full, follow the steps in "II.F.2. Float Switch Cleaning." After cleaning FS, check it again. Replace if necessary.

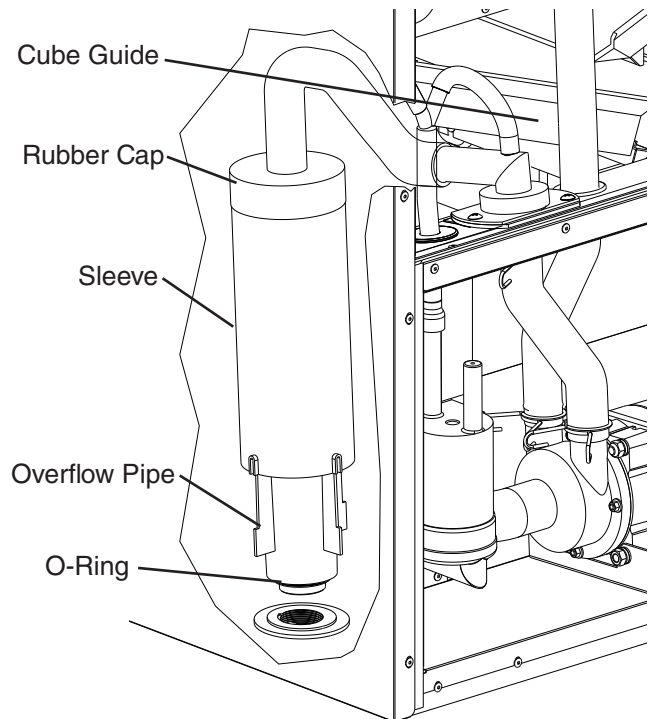

Fig. 8

Legend: **CB**—control board; **FS**—float switch

2. Float Switch Cleaning

Depending on local water conditions, scale may build up on FS. Scale on the switch can cause the float to stick. In this case, FS should be cleaned.

- 1) Turn off the power supply.
- 2) Remove the front panel, then move the control switch to the "OFF" position.
- 3) Drain the water tank. Remove the rubber cap covering the overflow pipe in the water tank. Remove the overflow pipe by turning it counterclockwise. After the water tank has drained, replace the overflow pipe and the rubber cap in their correct positions.
Note: Be sure the overflow pipe o-ring is in its correct position on the overflow pipe.
- 4) Disconnect the vent tube and the flush tube from the top of FS, then remove FS assembly and remove the rubber boot from the bottom of FS assembly. See Fig. 9.
- 5) Remove the retainer rod from the bottom of FS housing, then remove the float. Be careful not to bend the retainer rod excessively when removing it.
- 6) Wipe down FS housing, shaft, float, and retainer rod with a mixture of 1 part Hoshizaki "Scale Away" and 25 parts warm water. Clean the inside of the rubber boot and hose with cleaning solution. Rinse the parts thoroughly with clean water.
- 7) Reassemble FS assembly and replace it and the rubber boot in their correct positions. Reconnect the vent tube and the flush tube.
- 8) Move the control switch to the "ICE" position.
- 9) Replace the front panel in their correct positions.
- 10) Turn on the power supply to start the automatic icemaking process.

Legend: **CB**—control board; **FS**—float switch

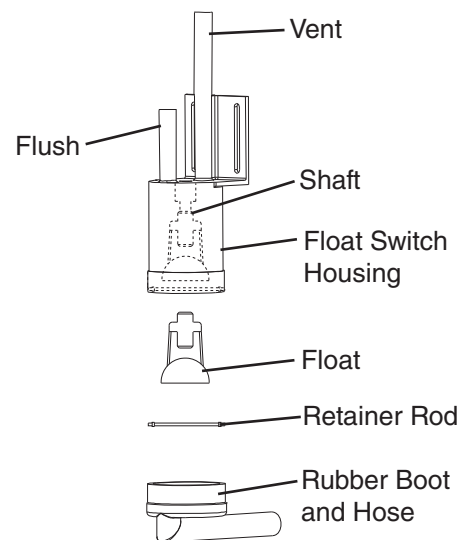

Fig. 9

G. Thermistor Check

To check thermistor resistance, follow the steps below.

- 1) Turn off the power supply.
- 2) Remove the front panel. Move the control switch to the "OFF" position.
- 3) Remove the control box cover.
- 4) Remove the thermistor from the refrigerant tubing.
- 5) Immerse the thermistor sensor portion in a glass containing ice and water for 2 or 3 min.
- 6) Disconnect the thermistor connector from CB K3 connector and check the resistance between thermistor leads. Normal range is 4.7 to 6.2 k Ω . If outside the normal range, replace the thermistor. See "IV.B. Component Service Information." If within the normal range, continue to the next step.
- 7) Replace the thermistor in its correct position. See "IV.B. Component Service Information."
- 8) Reconnect the thermistor connector to CB K3 connector.
- 9) Replace the control box cover in its correct position.
- 10) Move the control switch to the "ICE" position.
- 11) Replace the front panel in its correct position.
- 12) Turn on the power supply.
- 13) Once the harvest cycle starts (Comp energizes), begin timing the harvest cycle.
- 14) The harvest timer and harvest cycle should terminate within 2 to 5 min. If the harvest cycle does not terminate within 2 to 5 min., replace CB.

Legend: **CB**—control board; **Comp**—compressor

H. Control Switch

The control switch has three positions: "OFF" for power off, "ICE" for icemaking, and "WASH" to energize the pump motor when cleaning and sanitizing. **WARNING! Control switch in "OFF" position does not de-energize all loads. Risk of electric shock. Use extreme caution and exercise safe electrical practices.**

I. Diagnostic Tables

1. No Ice Production

No Ice Production - Possible Cause	
1. Power Supply	a) Off, blown fuse, or tripped breaker.
	b) Not within specifications.
2. Main Transformer (208-230/60/1 Models with main transformer and all 208-230/60/3 Models)	a) Voltage tap switch not set to proper voltage.
	b) Coil winding open or shorted.
3. Fuse (Control Box)	a) Blown.
4. Thermostatic Bin Control See "II.E.1. Thermostatic Bin Control Check"	a) Tripped with bin filled with ice.
	b) Ambient temperature too cool.
	c) Set too warm.
	d) Bulb out of position.
	e) Open contacts, defective.
5. Control Switch	a) In "OFF" or "WASH" position.
	b) Bad contacts.
6. High-Pressure Switch	a) Dirty condenser.
	b) Fan motor not operating.
	c) Refrigerant overcharged.
	d) Bad contacts.
	e) Refrigerant lines or components plugged.
7. Control Transformer (115VAC/10.5VAC)	a) Coil winding open or shorted.
8. Control Board See "II.D. Control Board Check"	a) In alarm.
	b1) Yellow "BC OPEN" LED on (bin full) (2A7664-01, 2A7664-02, and 2A7664-04)
	b2) Orange "BIN CLS" LED on (bin full) (2A9678-01 and 2A9678-02)
	c) Defective.
9. Mechanical Bin Control See "II.E.2. Mechanical Bin Control Check"	a) Tripped with bin filled with ice.
	b) Actuator does not move freely.
	c) Defective.
Ultrasonic Bin Control See "II.E.4. Ultrasonic Bin Control Check"	a) Tripped with bin filled with ice.
	b) Sensor lens dirty.
	c) Defective.
10. Water Supply	a) Water supply off or improper water pressure.
	b) External water filters clogged.
11. Inlet Water Valve	a) Screen or orifice clogged.
	b) Coil winding open.
	c) Water valve open in freeze cycle.
12. Float Switch See "II.F. Float Switch Check and Cleaning"	a) Float does not move freely.
	b) Defective.

No Ice Production - Possible Cause	
13. Compressor	a) Compressor relay/magnetic contactor contacts bad or coil winding open.
	b) Start capacitor or run capacitor defective (single phase).
	c) Internal protector open.
	d) Start relay contacts bad or coil winding open (single phase).
	e) Compressor defective.
14. Hot Gas Valve	a) Closed in harvest cycle.
	b) Open in freeze cycle.
15. Thermistor See "II.G. Thermistor Check"	a) Loose, disconnected, or defective.
16. Pump Motor	a) Motor winding open.
	b) Bearing worn out or locked rotor.
	c) Defective capacitor.
	d) Mechanical seal worn out.
17. Thermostatic Expansion Valve	a) Bulb loose.
	b) Operating erratically.
18. Liquid Line Valve	a) Closed in freeze cycle.
	b) Open in harvest cycle.
19. Fan Motor	a) Motor winding open.
	b) Bearing worn out or locked rotor.
	c) Defective capacitor.
20. Water System	a) Water leaks causing short freeze time.

2. Freeze-Up

Defrost and clean the icemaker prior to diagnosing freeze-up. Fill out a freeze-up checklist. See "II.J. Freeze Up Check List," the Hoshizaki America Technician's Pocket Guide, or contact your local distributor for a copy of the freeze-up checklist.

Freeze-Up - Possible Cause	
Harvest Cycle	
1. Evaporator	a) Scaled up.
	b) Damaged.
2. Cube Guides	a) Out of position.
	b) Damaged.
3. Spray Tubes and/or Spray Guides	a) Dirty.
	b) Out of position.
4. Water Supply	a) Low water pressure.
	b) External water filters clogged.
	c) Insufficient water line size. Minimum 1/4" Nominal ID (6 mm Nominal OD in the EU) copper water tubing or equivalent.
5. Inlet Water Valve	a) Screen or orifice clogged.
	b) Defective.
6. Float Switch See "II.F. Float Switch Check and Cleaning"	a) Dirty, sticking.
	b) Defective.

Freeze-Up - Possible Cause	
7. Refrigerant Charge	a) Low.
8. Control Board See "III.C. Settings and Adjustments" and "II.D. Control Board Check"	a) Harvest timer (S4 dip switch 1 & 2) set too short.
	b) Harvest pump timer (S4 dip switch 7) not in factory default position.
	c) Defective.
9. Bin Control See "II.E. Bin Control Check"	a) Dirty.
	b) Defective.
10. Thermistor See "II.G. Thermistor Check"	a) Loose, disconnected, or defective.
11. Thermostatic Expansion Valve	a) Defective.
12. Hot Gas Valve	a) Closed or restricted.
13. Liquid Line Valve	a) Open.
Freeze Cycle	
1. Evaporator	a) Scaled up.
	b) Damaged.
2. Spray Tubes and/or Spray Guides	a) Dirty.
	b) Out of position.
3. Refrigerant Charge	a) Low.
4. Control Board See "II.D. Control Board Check"	a) Freeze timer (S4 dip switch 9 & 10) set incorrectly.
	b) Defective.
5. Inlet Water Valve	a) Leaking by.
6. Float Switch See "II.F. Float Switch Check and Cleaning"	a) Float does not move freely.
	b) Defective.
7. Pump Motor	a) RPM too slow.
	b) Impeller damaged.
8. Thermostatic Expansion Valve	a) Bulb loose or defective.
9. Liquid Line Valve	a) Restricted.
10. Headmaster (C.P.R.) (remote models)	a) Not bypassing.

3. Low Ice Production

Low Ice Production - Possible Cause	
Long Harvest Cycle	
1. Evaporator	a) Scaled up.
2. Spray Tubes and/or Spray Guides	a) Dirty.
	b) Out of position.
3. Refrigerant Charge	a) Low.
4. Water Supply	a) Low water pressure.
	b) External water filters clogged.
	c) Insufficient water line size. Minimum 1/4" Nominal ID (6 mm Nominal OD in the EU) water tubing or equivalent.
	d) Too cold.
5. Control Board See "II.D. Control Board Check"	a) Thermistor connection loose (K3).
	b) Defective.
6. Thermistor See "II.G. Thermistor Check"	a) Loose, disconnected, or defective.
7. Hot Gas Valve	a) Erratic or closed.
8. Inlet Water Valve	a) Screen or orifice clogged.
9. Compressor	a) Inefficient or off.
10. Liquid Line Valve	a) Erratic or open.
11. Thermostatic Expansion Valve	a) Defective.
Long Freeze Cycle	
1. Evaporator	a) Scaled up, dirty.
2. Float Switch See "II.F. Float Switch Check and Cleaning"	a) Scaled up, dirty.
	b) Float sticking.
	c) Defective switch.
3. Inlet Water Valve	a) Leaking by.
4. Hot Gas Valve	a) Erratic or open.
5. Condenser	a) Clogged.
6. Control Board See "II.D. Control Board Check"	a) Float switch connection loose (K5).
	b) Defective.
7. Refrigerant Charge	a) Low.
8. Thermostatic Expansion Valve	a) Bulb loose.
	b) Defective.
9. Compressor	a) Inefficient or off.
10. Pump Motor	a) RPM too slow.
11. Liquid Line Valve	a) Erratic or restricted.
12. Headmaster (C.P.R.) (remote models)	a) Not bypassing.

J. Freeze-Up Check List

1. Thermostatic Bin Control

Freeze-Up Check List
Please Complete When Diagnosing a Freeze-Up, Refrigerant Leak, or Low Charge
 Technical Support Fax #: 770-487-3360
 Make Copies And Use As Needed

Model # _____ **Serial #** _____ **Install Date** _____ **Freeze-Up Date** _____

List model and manufacture of bin or dispenser _____.

Date appliance was last cleaned: _____.

Freeze-Up Defrost

YES NO

- [] [] 1) After defrosting, was the appliance leak checked?
- [] [] 2) Were any leaks found?
If so where? _____.
- [] [] 3) Was any refrigerant added to the unit?
If so, how much? _____.

Set Up

- [] [] 4) Is the appliance stand alone?
- [] [] 5) Is water line independent?
- [] [] 6) Is water line correct size? If not _____."
3/8" Nominal ID Copper Water Tubing or Equivalent.
- 7) What is water pressure? _____.
Water Temperature _____.
- [] [] 8) Does appliance have any water filtration?
If yes please list the following:
Filter brand _____.
Model _____.
Filter pressure gauge reading during the fill cycle _____.
Date filter was last replaced? _____.
GPM or LPM flow rate of filter system? _____.
- 9) Ambient temperature at appliance? _____.
At remote condenser (if applicable)? _____.

Appliance Status

- [] [] 10) Is the appliance and/or float switch dirty?
- 11) List the S4 (1-10) and S5 (1-5) DIP switch settings.
S4: 1 ___ 2 ___ 3 ___ 4 ___ 5 ___ 6 ___ 7 ___ 8 ___ 9 ___ 10 ___
S5: 1 ___ 2 ___ 3 ___ 4 ___ 5 ___
- [] [] 12) Is DIP switch number 7 ON (harvest pump time (harvest assist) all models and freeze-time correction models with control board 2A7664-02?
- [] [] 13) Is the cube guide positioned correctly?
- [] [] 14) Are the evaporator separators positioned properly?
- [] [] 15) Is the thermistor properly mounted, tight, and insulated?
- [] [] 16) Is the TXV bulb properly mounted, tight, and insulated?
- [] [] 17) Are splash guards in place?

Appliance Operation

Fill

YES NO

- [] [] 18) Does the water tank fill and overflow? 60-90 sec. Note: Larger models may take up to 120 seconds to overflow when empty.
- [] [] 19) If NO in step 17, is water flow 5GPM for larger?

Harvest

- [] [] 20) Is the hot gas valve opening?
- [] [] 21) Is harvest pump time (harvest assist) utilized (S4 dip switch 7)?
- [] [] 22) Is hot gas valve opening in harvest?
- [] [] 23) Does water valve close completely when deenergized?
- 24) What was length of harvest? _____.

Freeze

- [] [] 25) Is pump motor energized in freeze cycle except during 10-sec. anti-slush. If activated (S5 dip switch 5 on)?
- 26) Water-cooled condenser outlet temperature 5-min. into freeze? _____°F.
- 27) What was length of freeze? _____.
- [] [] 28) Is the cube size consistent from inlet to outlet of evaporator?
- [] [] 29) Is ice still dropping when next freeze cycle starts?
- 30) What is the ice drop weight? _____.
- 31) What is head pressure?
Freeze _____ Harvest _____.
(Freeze pressure should be taken 5 minutes into the cycle).
- 32) What is suction pressure?
Freeze _____ Harvest _____.
(Freeze pressure should be taken 5 minutes into the cycle).
- [] [] 33) Did appliance shutdown within 10 seconds when ice contacts the bin controls thermostatic bulb?

Freeze-Time Correction Operation - Control Board 2A7664-02

- [] [] 34) Has Freeze-Time Correction been activated? ("POWER OK" LED blinking).
- [] [] 35) Has moer than 1 Freeze-Time Correction been activated? ("POWER OK" LED and "EXT HARVEST" LED blinking).

Note: Make copies of this form and use it when diagnosing a freeze up condition. Submit a completed copy of the checklist along with the freeze-up labor claim form.

2. Mechanical Bin Control

Freeze-Up Check List
Please Complete When Diagnosing a Freeze-Up, Refrigerant Leak, or Low Charge
 Technical Support Fax #: 770-487-3360
 Make Copies And Use As Needed

Model # _____ **Serial #** _____ **Install Date** _____ **Fail Date** _____

List model and manufacture of bin or dispenser _____.

Date appliance was last cleaned: _____.

Freeze-Up Defrost

YES NO

- 1) After defrosting, was the appliance leak checked?
- 2) Were any leaks found?
If so where? _____.
- 3) Was any refrigerant added to the unit?
If so, how much? _____.

Set Up

- 4) Is the appliance stacked?
- 5) Is water line independent?
- 6) Is water line correct size? If not _____,"
3/8" Nominal ID Copper Water Tubing or Equivalent.
- 7) What is water pressure? _____.
Water Temperature _____.
- 8) Does appliance have any water filtration?
If yes please list the following:
Filter brand _____.
Model _____.
Filter pressure gauge reading during the fill cycle _____.
Date filter was last replaced? _____.
GPM or LPM flow rate of filter system? _____.
- 9) Ambient temperature at appliance? _____.
At remote condenser (if applicable)? _____.

Appliance Status

- 10) Is the appliance and/or float switch dirty?
- 11) List the S4 (1-10) and S5 (1-5) DIP switch settings.
S4: 1 ___ 2 ___ 3 ___ 4 ___ 5 ___ 6 ___ 7 ___ 8 ___ 9 ___ 10 ___
S5: 1 ___ 2 ___ 3 ___ 4 ___ 5 ___
- 12) Is DIP switch number 7 ON (harvest pump time (harvest assist)) all models and freeze-time correction models with control board 2A7664-02?
- 13) Is the cube guide positioned correctly?
- 14) Are the evaporator separators positioned properly?
- 15) Is the thermistor properly mounted, tight, and insulated?
- 16) Is the TXV bulb properly mounted, tight, and insulated?

Appliance Operation

YES NO

- 17) Does the water tank fill and overflow? 60-90 sec. Note: Larger models may take up to 120 seconds to overflow when empty.
- 18) If NO in step 17, is water flow 5GPM for larger?
- 19) Does the appliance utilize re-fill (S5 dip switch 2 and 3)?

Fill

Harvest

- 20) Is the hot gas valve opening?
- 21) Is harvest pump time (harvest assist) utilized (S4 dip switch 7)?
- 22) Is hot gas valve opening in harvest?
- 23) Does water valve close completely when deenergized?
- 24) What was length of harvest? _____.

Freeze

- 25) Is pump motor energized in freeze cycle except during 10-sec. anti-slush. If activated (S5 dip switch 5 on)?
- 26) Water-cooled condenser outlet temperature 5-min. into freeze? _____°F.
- 27) What was length of freeze time? _____.
- 28) Is the cube size consistent from inlet to outlet of evaporator?
- 29) Is ice still dropping when next freeze cycle starts?
- 30) What is the ice drop weight? _____.
- 31) What is head pressure?
Freeze _____ Harvest _____.
(Freeze pressure should be taken 5 minutes into the cycle).
- 32) What is suction pressure?
Freeze _____ Harvest _____.
(Freeze pressure should be taken 5 minutes into the cycle).
- 33) When activating bin control, did appliance shutdown within 15 seconds in the first 5 minutes of freeze cycle?

Freeze-Time Correction - Control Board 2A7664-02

- 34) Has Freeze-Time Correction been activated? ("POWER OK" LED blinking).
- 35) Has more than 1 Freeze-Time Correction been activated? ("POWER OK" LED and "EXT HARVEST" LED blinking).

Note: Make copies of this form and use it when diagnosing a freeze up condition. Submit a completed copy of the checklist along with the freeze-up labor claim form.

3. Ultrasonic Bin Control

Freeze-Up Check List
Please Complete When Diagnosing a Freeze-Up, Refrigerant Leak, or Low Charge
 Technical Support Fax #: 770-487-3360
 Make Copies And Use As Needed

Model # _____ **Serial #** _____ **Install Date** _____ **Freeze-Up Date** _____

List model and manufacture of bin or dispenser _____.

Date appliance was last cleaned: _____.

Freeze-Up Defrost

YES NO

- [] [] 1) After defrosting, was the appliance leak checked?
 [] [] 2) Were any leaks found?
 If so where? _____.
 [] [] 3) Was any refrigerant added to the unit?
 If so, how much? _____.

Set Up

- [] [] 4) Is the appliance stand alone?
 [] [] 5) Is water line independent?
 [] [] 6) Is water line correct size? If not _____,"
 3/8" Nominal ID Copper Water Tubing or
 Equivalent.
 7) What is water pressure? _____.
 Water Temperature _____.
 [] [] 8) Does appliance have any water filtration?
 If yes please list the following:
 Filter brand _____.
 Model _____.
 Filter pressure gauge reading during the fill
 cycle _____.
 Date filter was last
 replaced? _____.
 GPM or LPM flow rate of filter
 system? _____.
 9) Ambient temperature at appliance?
 _____.
 At remote condenser (if applicable)? _____.

Appliance Status

- [] [] 10) Is the appliance and/or float switch dirty?
 11) List the S4 (1-10) and S5 (1-5) DIP switch
 settings.
 S4: 1 _____ 2 _____ 3 _____ 4 _____ 5 _____ 6 _____ 7 _____ 8 _____ 9 _____ 10 _____
 S5: 1 _____ 2 _____ 3 _____ 4 _____ 5 _____
 [] [] 12) Is DIP switch number 7 ON (harvest pump time
 (harvest assist)) all models?
 [] [] 13) Is the cube guide positioned correctly?
 [] [] 14) Are the evaporator separators positioned
 properly?
 [] [] 15) Is the thermistor properly mounted, tight, and
 insulated?
 [] [] 16) Is the TXV bulb properly mounted, tight, and
 insulated?
 [] [] 17) Are splash guards in place (if applicable)?

Appliance Sequence of Operation

Fill

YES NO

- [] [] 18) Does the water tank fill and overflow?
 60-90 sec. Note: Larger models may take up to
 120 seconds to overflow when empty.
 [] [] 19) If NO in step 17, is water flow 5GPM for larger?

Harvest

- [] [] 20) Is the hot gas valve opening?
 [] [] 21) Is harvest pump time (harvest assist) on
 (S4 dip switch 7)?
 [] [] 22) Is hot gas valve opening in harvest?
 [] [] 23) Does water valve close completely when
 deenergized?
 24) What was length of harvest? _____.

Freeze

- [] [] 25) Is pump motor energized in freeze cycle except
 during 10-sec. anti-slush. If activated (S5 dip
 switch 5 on)?
 26) Water-cooled condenser outlet temperature
 5-min. into freeze? _____°F.
 27) What was length of freeze time? _____.
 [] [] 28) Is the cube size consistent from inlet to outlet of
 evaporator?
 [] [] 29) Is ice still dropping when next freeze cycle starts?
 30) What is the ice drop weight? _____.
 31) What is head pressure?
 Freeze _____ Harvest _____.
 (Freeze pressure should be taken 5 minutes into
 the freeze cycle).
 32) What is suction pressure?
 Freeze _____ Harvest _____.
 (Freeze pressure should be taken 5 minutes into
 the freeze cycle).
 [] [] 33) Did the appliance shut down on bin control within
 15 seconds in the first 5 minutes of freeze cycle?

Freeze-Up Detection - Control Board 2A9678-02 ONLY

- [] [] 34) Has Freeze-Up Detection been activated?
 ("POWER" LED blinking)
 See "II.B.2.c) Freeze-up detection (FUD)."
 [] [] 35) If activated, has there been 6 normal freeze
 cycles without FUD activation?
 [] [] 36) Is length of freeze time back to normal?

Note: Make copies of this form and use it when diagnosing a freeze up condition. Submit a completed copy of the checklist along with the freeze-up labor claim form.

III. Controls and Adjustments

- A Hoshizaki exclusive control board is employed in KM series appliances.
- All models are pretested and factory adjusted.
- For a control board check procedure, see "II.D. Control Board Check."

<i>NOTICE</i>
<ul style="list-style-type: none">• Fragile, handle very carefully.• The control board contains integrated circuits, which are susceptible to failure due to static discharge. It is especially important to touch the metal part of the icemaker when handling or replacing the control board.• Do not touch the electronic devices on the control board or the back of the control board.• Do not change wiring and connections. Do not misconnect K3 WHITE, K4 RED, and K5 BLACK, because the same connector is used for the thermistor, mechanical bin control, and float switch.• Do not short out power supply to test for voltage.• Always replace the whole control board assembly if it goes bad.

A. Control Board Layout

1. Auxiliary Code: P-2 and Earlier (KM-901M_J(Z)/3, KM-1100M_J(Z))

Auxiliary Code: N-3 and Earlier (KM-1340M_J(Z)/3, KM-1601MRJ(Z)/3)

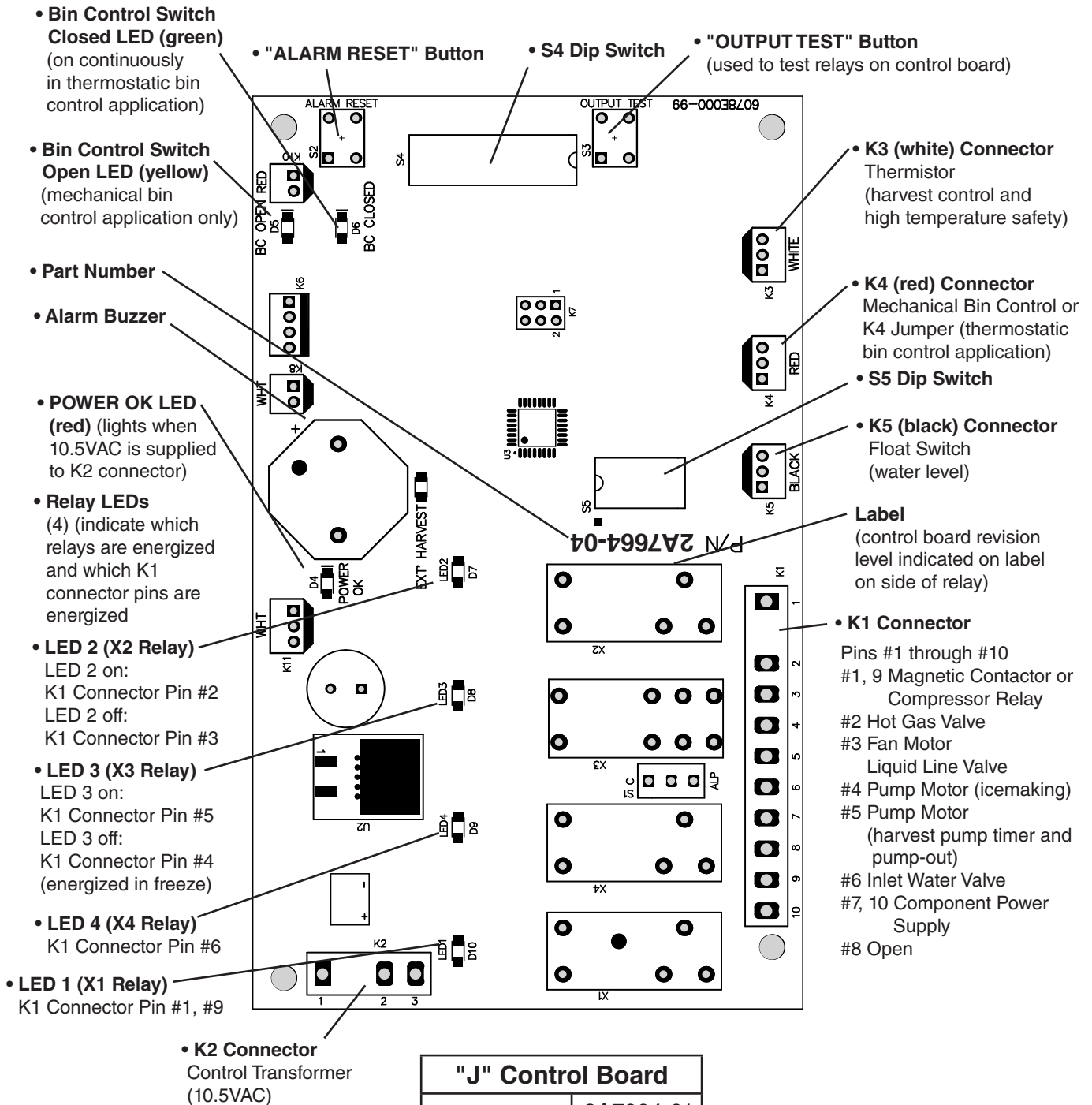

2. Auxiliary Code: P-3 and Later (KM-901M_J(Z)/3, KM-1100M_J(Z))

Auxiliary Code: P-0 and Later (KM-1340M_J(Z)/3, KM-1601MRJZ/3)

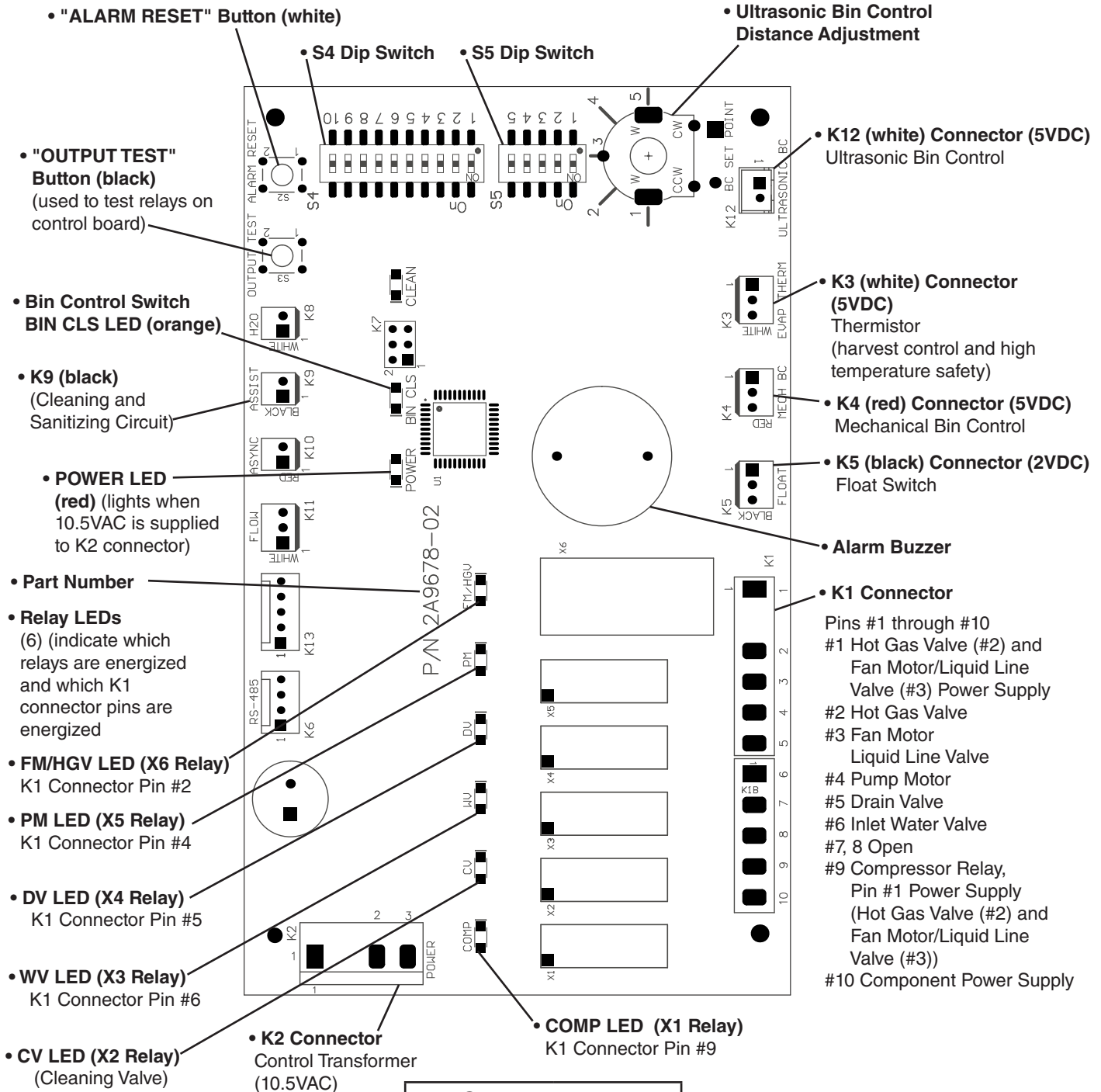

Control Board	
Part Number	2A9678-01
	2A9678-02

B. LED Lights and Audible Alarm Safeties

1. Auxiliary Code: P-2 and Earlier (KM-901M_J(Z)/3, KM-1100M_J(Z))

Auxiliary Code: N-3 and Earlier (KM-1340M_J(Z)/3, KM-1601MRJ(Z)/3)

Beep occurs and red "POWER OK" LED turns on when control switch is moved to "ICE" position.

Sequence

Green LEDs 1 through 4 turn on and sequence from initial startup as listed in the table below. Order of green LEDs from the outer edge of control board is 1, 4, 3, 2.

Sequence Step	LED	Energized Components	Time LEDs are On	
			Min.	Max.
1-Minute Fill Cycle	4	WV		
Harvest Cycle	1, 4, 2	Comp, FM*, FMR, HGV, WV	1 minute	20 minutes
Harvest Pump Time (harvest assist)	1, 3, 2	Comp, FM*, FMR, HGV, PM	0 seconds	50 seconds
Freeze Cycle	1	Comp, FM/FMR, PM, LLV	5 minutes	freeze timer setting
Anti-Slush Control	1, 3	Comp, FM/FMR, LLV	If S5 dip switch 5 on, PM off 10 sec. when thermistor at 36°F (2.2°C)	
Pump-Out Cycle	1, 4 [†] , 3, 2	Comp, FM*, FMR, HGV, PM, WV [†] , DV	10 seconds	20 seconds

*FM energized if on K1 Connector Pin #9; [†]pump-out timer setting

Alarms

Type	Alarm	Notes
1 Beep	High Evaporator Temp. (temperature > 127°F) (53°C)	Check for harvest problem (stuck HGV or relay), hot water entering unit, stuck HM, or shorted thermistor.
2 Beep	Harvest Backup Timer (harvest > 20 min. for two cycles in a row)	Check thermistor (open), HGV not opening, TXV or LLV leaking by, low charge, inefficient Comp, or WRV leaking by.
3 Beep	Freeze Timer (freeze > freeze timer setting for two cycles in a row)	Check FS stuck closed (up), WV leaking by, HGV leaking by, PM not pumping, TXV defective, LLV not opening, low charge, HM not bypassing, or inefficient Comp.
LED Blink	Freeze-Time Correction (CB-2A7664-02 only) (maximum freeze time differential exceeded)	Red POWER OK LED blinks. After 3 freeze-time correction cycles in 36 hours, yellow EXT HARVEST LED also blinks. Fill out freeze-up checklist. See "II.J. Freeze-Up Check List."
To reset above safeties, press "ALARM RESET" button with power supply on.		
6	Low Voltage (92Vac±5% or less)	Red LED turns off if voltage protection operates. Control voltage safeties automatically reset when voltage is corrected.
7	High Voltage (147Vac±5% or more)	

Legend: **CB**—control board; **Comp**—compressor; **FM**—fan motor; **FMR**—fan motor remote; **FS**—float switch; **HGV**—hot gas valve; **HM**—headmaster (C.P.R.); **LLV**—liquid line valve; **PM**—pump motor; **TXV**—thermostatic expansion valve; **WRV**—water regulating valve; **WV**—inlet water valve

2. Auxiliary Code: P-3 and Later (KM-901M_J(Z)/3, KM-1100M_J(Z))

Auxiliary Code: P-0 and Later (KM-1340M_J(Z)/3, KM-1601MRJZ/3)

Beep occurs and red CB "POWER" LED turns on when control switch is moved to "ICE" position.

Sequence

Green LEDs turn on and sequence from initial startup as listed in the table below. Order of green LEDs from the outer edge of control board is Comp, CV, WV, DV, PM, FM/HGV.

Sequence Step	LED	Energized Components	Time LEDs are On	
			Min.	Max.
1-Minute Fill Cycle	WV	WV		
Harvest Cycle	Comp, WV, **FM/HGV	Comp, FMR, HGV, WV	1 minute	20 minutes
Harvest Pump Time (harvest assist)	Comp, PM, **FM/HGV	Comp, FMR, HGV, PM	0 seconds	50 seconds
Freeze Cycle	Comp, PM	Comp, FM/FMR, PM, LLV	5 minutes	freeze timer setting
Anti-Slush Control	Comp	Comp, FM/FMR, LLV	PM off 10 sec. when thermistor at 36°F (2°C)	
Pump-Out Cycle	Comp, PM, **FM/HGV, DV, *WV	Comp, FMR, HGV, PM, *WV, DV	10 seconds	20 seconds

*pump-out timer setting **FM is OFF when FM/HGV is ON

Alarms

Type	Alarm	Notes
1 Beep	High Evaporator Temp. (temperature > 127°F) (53°C)	Check for harvest problem (stuck HGV or relay), hot water entering unit, stuck HM, or shorted thermistor.
2 Beep	Harvest Backup Timer (harvest > 20 min. for two cycles in a row)	Check thermistor (open), HGV not opening, TXV or LLV leaking by, low charge, inefficient Comp, or WRV leaking by.
3 Beep	Freeze Timer (freeze > freeze timer setting for two cycles in a row)	Check FS stuck closed (up), WV leaking by, HGV leaking by, PM not pumping, TXV defective, LLV not opening, low charge, HM not bypassing, or inefficient Comp.
"POWER" LED Blinks	*Freeze-up Detection Time for thermistor to reach 2°C after Freeze Cycle starts is less than 30 sec. Or Time for thermistor to reach 2°C after Freeze Cycle starts is both less than 90 sec. and 40 sec. shorter than previous cycle. *2A9678-02 ONLY	Red "POWER" LED blinks. Fill out freeze-up checklist. See "II.J. Freeze-Up Check List." Contact Tech Support at 1-800-233-1940.
To reset above safeties, press "ALARM RESET" button with power supply on.		
6	Low Voltage (92Vac±5% or less)	Red LED turns off if voltage protection operates. Control voltage safeties automatically reset when voltage is corrected.
7	High Voltage (147Vac±5% or more)	

Legend: **Comp**—compressor; **CV**—cleaning valve; **DV**—drain valve; **FM**—fan motor; **FMR**—fan motor remote; **FS**—float switch; **HGV**—hot gas valve; **HM**—headmaster (C.P.R.); **LLV**—liquid line valve; **PM**—pump motor; **TXV**—thermostatic expansion valve; **WRV**—water regulating valve; **WV**—inlet water valve

C. Settings and Adjustments

NOTICE

Dip switches are factory set. Failure to maintain factory settings may adversely affect performance and warranty coverage. For more information, contact your Hoshizaki Service Center.

1a. Default Dip Switch Settings

Auxiliary Code: P-2 and Earlier (KM-901M_J(Z)/3, KM-1100M_J(Z))

Auxiliary Code: N-3 and Earlier (KM-1340M_J(Z)/3, KM-1601MRJ(Z)/3)

The dip switches are factory-adjusted to the following positions for the 2A7664-01, 2A7664-02 and 2A7664-04 control boards:

S4 Dip Switch No.	1	2	3	4	5	6	7	8	9	10
KM-901MAJ KM-1100M_J(Z)	OFF	OFF	OFF	OFF	OFF	OFF	ON	OFF	OFF	OFF
KM-901MWJ KM-901MRJ(Z)	ON	OFF	OFF	OFF	OFF	OFF	ON	OFF	OFF	OFF
KM-1340MAJ KM-1340MWJ KM-1601M_J(Z)	OFF	OFF	OFF	OFF	OFF	OFF	ON	OFF	OFF	OFF
KM-1340MRJ(Z)	ON	OFF	OFF	OFF	OFF	OFF	ON	OFF	OFF	OFF
KM-1340MRJ(Z)3 KM-1601MRJ(Z)3	OFF	OFF	OFF	OFF	OFF	OFF	ON	OFF	OFF	OFF

S5 Dip Switch (Do Not Adjust) "J" Control Board					
Dip Switch No.	1	2	3	4	5
KM-901MAJ, MWJ, MRJ(Z)/3	OFF	OFF	OFF	OFF	OFF
KM-1100MAJ, MWJ, MRJ(Z) KM-1340MAJ, MWJ, MRJ(Z)/3 KM-1601MRJ(Z)/3	OFF	OFF	OFF	OFF	ON

S4 Dip Switch

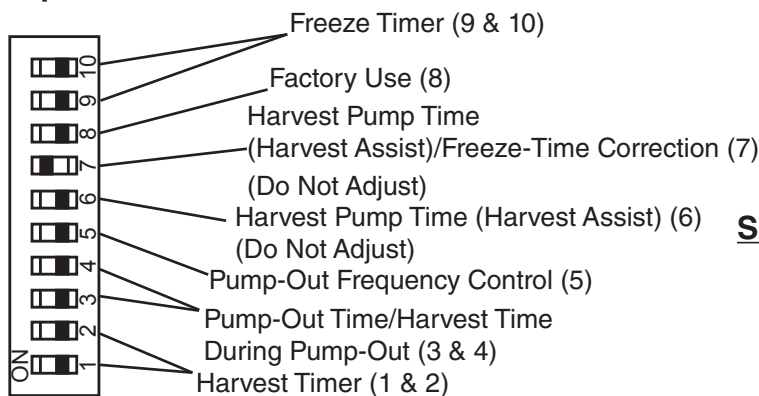

S5 Dip Switch

Do Not Adjust

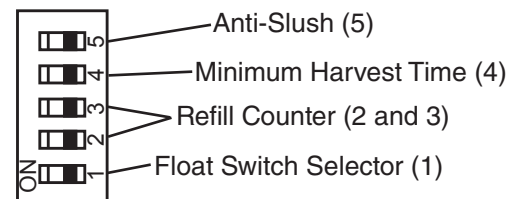

1b. Default Dip Switch Settings

Auxiliary Code: P-3 and Later (KM-901M_J(Z)/3, KM-1100M_J(Z))

Auxiliary Code: P-0 and Later (KM-1340M_J(Z)/3, KM-1601MRJZ/3)

The dip switches are factory-adjusted to the following positions for the 2A9678-01 and 2A9678-02 control boards:

S4 Dip Switch No.	1	2	3	4	5	6	7	8	9	10
KM-901MAJ KM-1100M_J(Z)	OFF	OFF	OFF	OFF	OFF	OFF	ON	OFF	OFF	OFF
KM-901MWJ KM-901MRJ(Z)/3	ON	OFF	OFF	OFF	OFF	OFF	ON	OFF	OFF	OFF
KM-1340M_J(Z) KM-1601MRJZ	OFF	OFF	OFF	OFF	OFF	OFF	ON	OFF	OFF	OFF
KM-1340MRJ(Z)	OFF	OFF	OFF	OFF	OFF	OFF	ON	OFF	OFF	OFF
KM-1340MRJ(Z)3 KM-1601MRJ(Z)3	OFF	OFF	OFF	OFF	OFF	OFF	ON	OFF	OFF	OFF

S5 Dip Switch (Do Not Adjust)					
Dip Switch No.	1	2	3	4	5
KM-901M_J(Z) KM-1100M_J(Z) KM-1340MRJZ KM-1601MRJZ	OFF	OFF	OFF	OFF	OFF
KM-901MRJZ3 KM-1340MAJ, MWJ, MRJ(Z)3 KM-1601MRJ(Z)3	OFF	OFF	OFF	OFF	ON

S4 Dip Switch

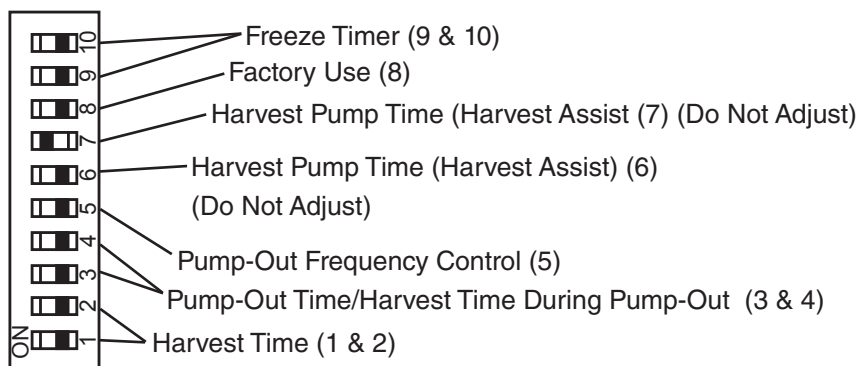

S5 Dip Switch

(Do Not Adjust)

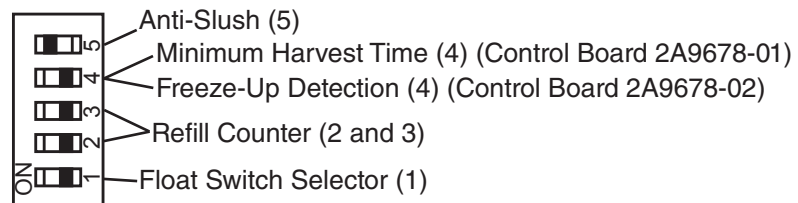

2. Harvest Timer (S4 dip switch 1 & 2)

The harvest timer starts counting when the thermistor reaches 48°F (9°C) at the evaporator outlet and the control board reads 3.9 kΩ from the thermistor. The harvest timer is factory set, and generally no adjustment is required. However, a setting longer than the factory setting may be advised in cases where the drain provided at harvest needs to be prolonged for extra cleaning. Before changing this setting, contact Hoshizaki Technical Support at 1-800-233-1940 for recommendations. Keep in mind that setting the harvest timer to a longer setting decreases 24-hour production.

Note that the pump-out timer (S4 dip switch 3 & 4) acts in place of the harvest timer during cycles with a pump out. For details, see "III.C.3. Pump-Out Timer (S4 dip switch 3 & 4)."

Note: On models with a pump-out every cycle, the harvest timer is only relevant during the initial harvest cycle since a pump out occurs every cycle thereafter.

S4 Dip Switch Setting		Time (sec.)
No. 1	No. 2	
OFF	OFF	60
ON	OFF	90
OFF	ON	120
ON	ON	180

3. Pump-Out Timer/Harvest Time During Pump-Out (S4 dip switch 3 & 4)

NOTICE

- On models with harvest pump timer, do not adjust 3 off and 4 on. Pump does not run in pump-out rotation in this setting.

When a pump-out is called for, the pump motor stops for 2 sec., then energizes in the reverse direction, taking water from the bottom of the water tank and forcing pressure against the check valve seat allowing water to go through the check valve and down the drain. At the same time, water flows through the small tube to power flush the float switch. The pump motor drains the water tank for the time determined by the pump-out timer. The pump-out timer also acts in place of the harvest timer during cycles with a pump-out. The pump-out timer is factory set, and generally no adjustment is required. However, where water quality is bad and the icemaker needs a longer pump-out time, the pump-out timer can be adjusted. The pump-out timer control can be set to pump-out for 10 or 20 sec.

S4 Dip Switch Setting		Time (sec.)		Inlet Water Valve
No. 3	No. 4	T1	T2	
OFF	OFF	10	150	Closed
ON	OFF	10	180	Closed
OFF	ON	10	120	Open
ON	ON	20	180	Closed

T1: Time to drain the water tank

T2: Harvest timer at pump out

4. Pump-Out Frequency Control (S4 dip switch 5)

The pump-out frequency control is factory set to drain the water tank every 10 cycles. Generally no adjustment is required. However, where water quality is bad and the icemaker needs a pump-out more often, the pump-out frequency can be adjusted. The pump-out frequency control can be set to have a pump-out occur every cycle, or every 10 cycles.

The first pump-out is dependent on S4 dip switch 5. See the table below.

S4 Dip Switch Setting	Pump-Out Frequency	1st Pump-Out
No. 5		
OFF	Every 10 cycles	After 11th freeze cycle
ON	Every cycle	After 2nd freeze cycle

5. Harvest Pump Time (Harvest Assist) (S4 dip switch 6)

NOTICE

Factory set for proper operation. Do not adjust. Adjustment outside of the factory default setting may result in damage to the appliance.

Harvest pump time (harvest assist) is only active when S4 dip switch 7 is in the "ON" position. In the factory default position, the harvest pump time (harvest assist) starts with 50 sec. left to go in harvest cycle (S4 dip switch 6) and after the thermistor reaches 48°F (9°C) at the evaporator outlet and the control board reads 3.9 kΩ from the thermistor. The harvest pump time (harvest assist) is factory set, and no adjustment is required.

S4 Dip Switch Setting	Harvest Pump Time (Harvest Assist)	
	S5-4 OFF	S5-4 ON
No. 6		
OFF	50 sec.	25 sec.
ON	25 sec.	15 sec.

6. Harvest Pump Time (Harvest Assist)/Freeze-Time Correction (S4 dip switch 7)

NOTICE

Factory set for proper operation. Do not adjust. Adjustment outside of the factory default setting may result in damage to the appliance.

Auxiliary Code: P-2 and Earlier (KM-901M_J(Z)/3, KM-1100M_J(Z))

Auxiliary Code: N-3 and Earlier (KM-1340M_J(Z)/3, KM-1601MRJ(Z)/3)

a) Harvest Pump Time (Harvest Assist)

Depending on S4 dip switch 7 setting, the pump motor either stays off or is energized during the last seconds of the harvest cycle. When the pump motor is energized (S4 dip switch 7 on), water circulates over the evaporator. The harvest water valve is open during harvest for a maximum of 6 minutes or the length of harvest minus the harvest pump time value (S4 dip switch 6), whichever is shorter.

When S4 dip switch 7 is in the on position and harvest begins, X11 and X10 relays energize. A latching circuit is created through the X11 and X10 relays. For further details, see "VIII.B. Wiring Diagrams." In the factory default position, 50 sec. before harvest termination, LED 4 turns off, inlet water valve and X11 relay de-energize. X10 relay remains energized through the latching circuit. Next, LED 3 turns on and control board K1 connector pin #5 (DBU wire) energizes, energizing the pump motor for the last seconds of harvest. Harvest pump time adjusted by S4 dip switch 1 & 2 and S5 dip switch 4 settings. Contact Technical Support before adjusted these settings.

b) Freeze-Time Correction

When S4 dip switch 7 is in the on position, freeze-time correction enabled. See "II.B.1.c) Freeze-Time Correction Cycle (90 min.)."

S4 Dip Switch Setting	Harvest Pump Time	Freeze-Time Correction
No. 7	(Harvest Assist)	(CB: 2A7664-02)
OFF		Disabled
ON		Enabled

Auxiliary Code: P-3 and Later (KM-901M_J(Z)/3, KM-1100M_J(Z))

Auxiliary Code: P-0 and Later (KM-1340M_J(Z)/3, KM-1601MRJZ/3)

Depending on S4 dip switch 7 setting, the pump motor either stays off or is energized during the last seconds of the harvest cycle. When the pump motor is energized (S4 dip switch 7 on), water circulates over the evaporator. The harvest water valve is open during harvest for a maximum of 6 minutes or the length of harvest minus the harvest pump time value (S4 dip switch 6), whichever is shorter.

When S4 dip switch 7 is in the on position and harvest begins, 50 sec. before harvest termination, WV LED turns off. Next, PM LED turns on and control board K1 connector pin #4 (R) energizes, energizing the pump motor for the last seconds of harvest. Harvest pump time adjusted by S4 dip switch 1 & 2 and S5 dip switch 4 settings. Contact Hoshizaki Technical Support at 1-800-233-1940 before adjusting these settings.

S4 Dip Switch Setting	Harvest Pump Time (sec.) (Harvest Assist)
No. 7	
OFF	0
ON	50

7. Factory Use (S4 dip switch 8)

Factory set for proper operation. Do not adjust. This must be left in the factory default position.

8. Freeze Timer (S4 dip switch 9 & 10)

NOTICE
Adjust to proper specification, or the icemaker may not operate correctly.

The freeze timer setting determines the maximum allowed freeze time to prevent possible freeze-up issues. Upon termination of the freeze timer, the control board initiates the harvest cycle or pump-out cycle. After 2 consecutive freeze timer terminations, the control board shuts down the icemaker. In this case, see "II.1.3. Low Ice Production" for possible solutions. The freeze timer is factory set and no adjustment is required. Before changing this setting, contact Hoshizaki Technical Support at 1-800-233-1940 for recommendations.

S4 Dip Switch Setting		Time (min.)
No. 9	No. 10	
OFF	OFF	60
OFF	ON	50
ON	OFF	70
ON	ON	75

9. Pump-Out Pump Motor Selector (S5 dip switch 1)

This dip switch setting allows use of this control board to control pump motor during pump-out mode.

NOTICE	
Do not adjust. This must be left in the factory default position for normal pump-out operation.	

S5 Dip Switch Setting	Pump-Out Pump Motor
No. 1	
OFF	During Pump-Out (Pump Motor & Drain Valve ON)
ON	During Pump-Out (Pump Motor OFF, Drain Valve ON)

10. Refill Counter (S5 dip switch 2 and 3)

NOTICE	
Do not adjust. These must be left in the factory default position or the icemaker will not operate correctly.	

S5 Dip Switch Setting		Refill Counter
No. 2	No. 3	
OFF	OFF	0
OFF	ON	1 refill
ON	OFF	9 refills
ON	ON	10 refills

11. Minimum Harvest Time (S5 dip switch 4)

NOTICE	
Factory set for proper operation. Do not adjust. Adjustment outside the factory default setting may result in damage to the appliance.	

a) Control Board 2A9678-01

S5 Dip Switch Setting	Minimum Harvest Timer
No. 4	
OFF	120 sec.
ON	70 sec.

b) Control Board 2A9678-02

See "II.A.4. Freeze-Up Detection Flowchart".

S5 Dip Switch Setting	Freeze-up Detection
No. 4	
OFF	Enabled
ON	Disabled

12. Anti-Slush (S5 dip switch 5)

This dip switch setting provides anti-slush control during the freeze cycle. When the evaporator temperature reaches 36°F (2.2°C) the control board reads a 5.8kΩ signal from the thermistor and de-energizes the water pump for 10 sec. to melt ice slush and prevent ice slush from blocking the water supply tubing, causing irregular freeze patterns.

NOTICE

Factory set for proper operation. Do not adjust. Adjustment outside the factory default setting may result in damage to the appliance.

S5 Dip Switch Setting	
No. 5	Anti-Slush
OFF	Disabled
ON	Enabled

IV. Refrigeration Circuit and Component Service Information

WARNING

- This appliance should be diagnosed and repaired only by qualified service personnel to reduce the risk of death, electric shock, serious injury, or fire.
- Move the control switch to the "OFF" position and turn off the power supply. Place the disconnect in the "OFF" position. Lockout/Tagout to prevent the power supply from being turned back on inadvertently.
- **CHOKING HAZARD:** Ensure all components, fasteners, and thumbscrews are securely in place after the icemaker is serviced. Make sure that none have fallen into the dispenser unit/ice storage bin.
- Make sure all food zones in the icemaker and dispenser unit/ice storage bin are clean after service.

A. Refrigeration Circuit Service Information

WARNING

- Repairs requiring the refrigeration circuit to be opened must be performed by properly trained and EPA-certified service personnel.
- Use an electronic leak detector or soap bubbles to check for leaks. Add a trace of refrigerant to the system (if using an electronic leak detector), and then raise the pressure using nitrogen gas (140 PSIG). Do not use R-404A as a mixture with pressurized air for leak testing.

NOTICE

- Always recover the refrigerant and store it in an approved container. Do not discharge the refrigerant into the atmosphere.
- Do not leave the system open for longer than 15 min. when replacing or servicing parts. The Polyol Ester (POE) oils used in R-404A applications can absorb moisture quickly. Therefore it is important to prevent moisture from entering the system when replacing or servicing parts.
- Always install a new drier every time the sealed refrigeration system is opened. Do not replace the drier until after all other repair or replacement has been made. Install the new drier with the arrow on the drier in the direction of the refrigerant flow.
- When brazing, protect the drier by using a wet cloth to prevent the drier from overheating. Do not allow the drier to exceed 250°F (121°C).

1. Refrigerant Recovery

The icemaker is provided with refrigerant access valves. Using proper refrigerant practices, recover the refrigerant. Store the refrigerant in an approved container. Do not discharge the refrigerant into the atmosphere.

2. Brazing

⚠ WARNING

- R-404A itself is not flammable at atmospheric pressure and temperatures up to 176°F (80°C).
- R-404A itself is not explosive or poisonous. However, when exposed to high temperatures (open flames), R-404A can be decomposed to form hydrofluoric acid and carbonyl fluoride both of which are hazardous.
- Do not use silver alloy or copper alloy containing arsenic.

- 1) Braze all fittings while purging with nitrogen gas flowing at a pressure of 3 to 4 PSIG.
Note: Because the pipes in the evaporator case are specially coated to resist corrosion, it is important to make connections outside the evaporator case when possible. If it is necessary to braze inside the evaporator case, use sandpaper to remove the coating from the brazing connections before unbrazing the components.

NOTICE

- Always install a new drier every time the sealed refrigeration system is opened.
- Do not replace the drier until after all other repair or replacement has been made. Install the new drier with the arrow on the drier in the direction of the refrigerant flow.
- When brazing, protect the drier by using a wet cloth to prevent the drier from overheating. Do not allow the drier to exceed 250°F (121°C).

- 2) Use an electronic leak detector or soap bubbles to check for leaks. Add a trace of refrigerant to the system (if using an electronic leak detector), and then raise the pressure using nitrogen gas (140 PSIG). Do not use R-404A as a mixture with pressurized air for leak testing.

3. Evacuation and Recharge (R-404A)

- 1) Attach a vacuum pump to the system. Be sure to connect the charging hoses to both high and low-side refrigerant access valves.

IMPORTANT

The vacuum level and vacuum pump may be the same as those for current refrigerants. However, the rubber hose and gauge manifold to be used for evacuation and refrigerant charge should be exclusively for POE oils.

- 2) Turn on the vacuum pump. Open the gauge manifold valves. Never allow the oil in the vacuum pump to flow backwards.
- 3) Allow the vacuum pump to pull down to a 29.9" Hg vacuum. Evacuating period depends on pump capacity.
- 4) Close the low-side valve and high-side valve on the gauge manifold.

- 5) Disconnect the gauge manifold hose from the vacuum pump and attach it to a refrigerant service cylinder. Remember to loosen the connection and purge the air from the hose. For the required refrigerant charge, see the rating label inside the icemaker. Hoshizaki recommends only virgin refrigerant or reclaimed refrigerant which meets ARI Standard 700 (latest edition) be used.
- 6) A liquid charge is required when charging an R-404A system (to prevent fractionation). Place the service cylinder on the scales; if the service cylinder is not equipped with a dip tube, invert the service cylinder, then place it on the scales. Open the high-side valve on the gauge manifold.
- 7) Allow the system to charge with liquid until the proper charge weight is met.
- 8) If necessary, add any remaining charge to the system through the low-side.
NOTICE! To prevent compressor damage, use a throttling valve or liquid dispensing device to add the remaining liquid charge through the low-side refrigerant access valve with the icemaker running.
- 9) Close the high and low-side gauge manifold valves, then disconnect the gauge manifold hoses.
- 10) Cap the refrigerant access valves to prevent a possible leak.

B. Component Service Information

NOTICE

When replacing a component listed below, see the notes to help ensure proper operation.

Component	Notes
Compressor	1 phase: Install a new start capacitor, run capacitor, and start relay. 3 phase: Install a new magnetic contactor.
Thermostatic Expansion Valves	<ul style="list-style-type: none"> • Attach the thermostatic expansion valve bulb to the suction line in the same location as the previous bulb. • The bulb should be between the 10 and 2 o'clock positions on the tube. • Secure the bulb with the clamp and holder, then insulate it.
Hot Gas Valves Liquid Line Valves	<ul style="list-style-type: none"> • Replace the strainer if applicable. • Use copper tube of the same diameter and length when replacing valve lines.
Fan Motors	Install a new capacitor.
Pump Motor	Install a new capacitor.
Thermistor	<ul style="list-style-type: none"> • Attach the new thermistor to the suction line in the same location as the previous thermistor. • The thermistor should be at the 12 o'clock position on the tube. • Smoothly fill the recessed area of the thermistor holder with high thermal conductive type sealant. Hoshizaki America part number 4A0683-01 (Silicone Heat Sink Compound 10-8108 manufactured by GC Electronics), KE-4560 RTV (manufactured by ShinEtsu Silicones), or equivalent are recommended. • Secure the thermistor with the holder, then insulate it. • Be very careful to prevent damage to the leads.

C. Water Regulating Valve Adjustment (water-cooled model)

The water regulating valve is factory set, and generally no adjustment is required. However, when necessary, adjust the water regulator using the following procedure.

- 1) Prepare a thermometer to check the condenser drain temperature. Attach a pressure gauge to the high-side line of the system.
- 2) 5 min. after a freeze cycle starts, confirm that the thermometer reads 104°F to 115°F (40°C to 46°C). If it does not, rotate the adjustment screw by using a flat blade screwdriver until the temperature is in the proper range. See Fig. 10. Next, check that the reference pressure is in the range indicated in the Head Pressure table in the Performance Data section. If it is not in the proper range, verify the refrigerant charge.

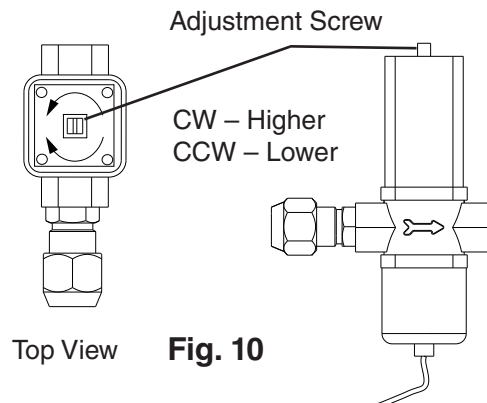

Fig. 10

- 3) Check that the condenser drain temperature is stable.

V. Maintenance

The maintenance schedule below is a guideline. More frequent maintenance may be required depending on water quality, the appliance's environment, and local sanitation regulations

⚠ WARNING	
<ul style="list-style-type: none"> • Only qualified service technicians should service the appliance. • To reduce the risk of electric shock, do not touch the control switch or service switch with damp hands • Before servicing: Move the control switch to the "OFF" position and turn off the power supply. Place the disconnect in the "OFF" position. Lockout/Tagout to prevent the power supply from being turned back on inadvertently. • CHOKING HAZARD: Ensure all components, fasteners, and thumbscrews are securely in place after any maintenance is done to the icemaker. Make sure that none have fallen into the dispenser unit/ice storage bin. 	

Maintenance Schedule		
Frequency	Area	Task
Daily	Scoop	Clean the ice scoop using a neutral cleaner. Rinse thoroughly after cleaning.
Bi-Weekly	Air Filters	Inspect. Wash with warm water and neutral cleaner if dirty.
Monthly	External Water Filters	Check for proper pressure and change if necessary.
	Bin Control Lens	Wipe down the bin control lens, (located on the bottom of the icemaker) with a neutral cleaner. Rinse thoroughly after cleaning.
	Icemaker Exterior	Wipe down with a clean, soft cloth. Use a damp cloth containing a neutral cleaner to wipe off oil or dirt build up. Clean any chlorine staining (rust colored spots) using a non-abrasive cleanser.
	Underside of Icemaker and Top Kits; Bin Door and Snout	Wipe down with a clean cloth and warm water.
Yearly	Icemaker and Dispenser Unit/Ice Storage Bin Liner	Clean and sanitize per the cleaning and sanitizing instructions provided in the instruction manual or maintenance label on the icemaker.
	Water Supply Inlet	Close the icemaker water supply line shut-off valve and drain the water system. Clean the water supply inlet screen.
	Condenser	Inspect. Clean if necessary by using a brush or vacuum cleaner. More frequent cleaning may be required depending on location.
	Water Hoses	Inspect the water hoses and clean/replace if necessary.

VI. Preparing the Appliance for Periods of Non-Use

NOTICE

- When storing the appliance for an extended time or in sub-freezing temperatures, follow the instructions below to prevent damage.
- To prevent damage to the water pump, do not operate the appliance with the control switch in the "WASH" position when the water tank is empty.

When the appliance is not used for two or three days under normal conditions, it is sufficient to move the control switch to the "OFF" position. When storing the appliance for an extended time or in sub-freezing temperatures, follow the instructions below.

1. Remove the water from the icemaker water line:

- 1) Turn off the power supply, then remove the front panel.
- 2) Close the icemaker water supply line shut-off valve and open the icemaker water supply line drain valve.
- 3) Allow the line to drain by gravity.
- 4) Attach a compressed air or carbon dioxide supply to the icemaker water supply line drain valve.
- 5) Make sure at least 3 min. have elapsed since you turned off the power supply. Make sure the control switch is in the "ICE" position. Replace the front panel in its correct position, then turn on the power supply.
- 6) Blow the icemaker water supply line out using the compressed air or carbon dioxide supply.
- 7) Close the icemaker water supply line drain valve.

2. Remove the water from the water tank:

- 1) Turn off the power supply, then remove the front panel.
- 2) Move the control switch to the "OFF" position.
- 3) Drain the water tank.
 - a) Remove the front insulation. Disconnect the discharge hose. Remove the splash guard and cube guide. See Fig. 11.
 - b) Remove the rubber cap covering the overflow pipe in the water tank. Remove the overflow pipe by turning it counterclockwise. After the water tank has drained, replace the overflow pipe and the rubber cap in their correct positions. Note: Be sure the overflow pipe o-ring is in its correct position on the overflow pipe.
- 4) Replace the cube guide and splash guard. Re-connect the discharge hose, and replace the front insulation and front panel in their correct positions.
- 5) Remove all ice from the dispensing unit/ice storage bin. Clean the storage bin liner using a neutral cleaner. Rinse thoroughly after cleaning.

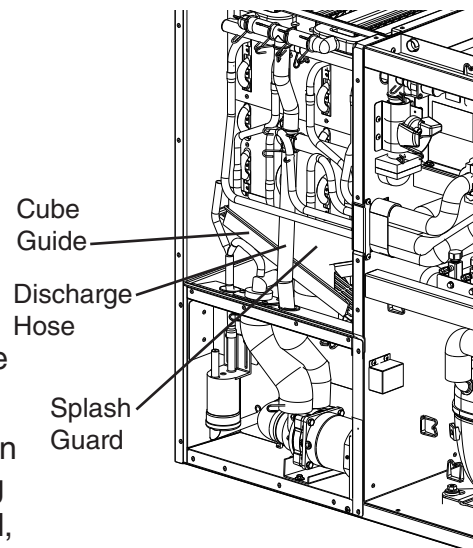

Fig. 11

3. On water-cooled model, remove the water from the water-cooled condenser:

- 1) Make sure the power supply is off, then remove the front panel and right side panel.
- 2) Close the condenser water supply line shut-off valve. If connected to a closed loop system, also close the condenser return line shut-off valve.
- 3) Open the condenser water supply line drain valve. If connected to a closed loop system, also open the condenser return line drain valve.
- 4) Attach a compressed air or carbon dioxide supply to the condenser water supply line drain valve.
- 5) Open the water regulating valve by using a screwdriver to pry up on the spring retainer underneath the spring. While holding the valve open, blow out the condenser using the compressed air or carbon dioxide supply until water stops coming out.
- 6) Close the drain valve(s).
- 7) Replace the right side panel and front panel in their correct positions.

VII. Disposal

The appliance contains refrigerant and must be disposed of in accordance with applicable national, state, and local codes and regulations. Refrigerant must be recovered by properly certified service personnel.

VIII. Technical Information

We reserve the right to make changes in specifications and design without prior notice.

A. Specification and Performance Data Sheets

Pressure data is recorded at 5 min. into freezing cycle. The data not in bold should be used for reference only.

1. KM-901MAJ

Specification Sheet

AC SUPPLY VOLTAGE	208-230/60/1 (3 WIRE WITH NEUTRAL FOR 115V)	
AMPERAGE	13 A	
MINIMUM CIRCUIT AMPACITY	20 A	
MAXIMUM FUSE SIZE	20 A	
ELECTRIC & WATER CONSUMPTION	90/70°F	70/50°F
ELECTRIC W (kWH/100 lbs.)	1570(5.00)	1510(4.00)
WATER gal./24HR (gal./100 lbs.)	166(22.0)	453(50.0)
ICE PRODUCTION PER CYCLE	19.7 lbs. (8.9 kg) 960pcs.	
BIN CONTROL SYSTEM	Ultrasonic	
REFRIGERANT CHARGE	R404A, 3 lb. 4.9 oz. (1500g)	

Performance Data Sheet

APPROXIMATE ICE PRODUCTION PER 24 HR.	AMBIENT TEMP. (°F/°C)	WATER TEMP. (°F/°C)					
		50/10		70/21		90/32	
	70/21	905	<u>411</u>	860	<u>390</u>	806	<u>366</u>
	80/27	871	<u>395</u>	802	<u>364</u>	751	<u>341</u>
	90/32	860	<u>390</u>	753	<u>342</u>	699	<u>317</u>
lbs./day kg./day	100/38	852	<u>386</u>	740	<u>336</u>	650	<u>295</u>
APPROXIMATE ELECTRIC CONSUMPTION	70/21	1510		1528		1576	
	80/27	1523		1551		1613	
	90/32	1528		1570		1627	
watts	100/38	1545		1583		1680	
APPROXIMATE WATER CONSUMPTION PER 24 HR.	70/21	453	<u>1.71</u>	368	<u>1.39</u>	317	<u>1.20</u>
	80/27	388	<u>1.47</u>	258	<u>0.98</u>	242	<u>0.92</u>
	90/32	368	<u>1.39</u>	166	<u>0.63</u>	134	<u>0.51</u>
gal./day m ³ /day	100/38	269	<u>1.02</u>	158	<u>0.60</u>	104	<u>0.39</u>
FREEZING CYCLE TIME	70/21	29		31		33	
	80/27	31		34		36	
	90/32	31		36		38	
min.	100/38	31		37		40	
HARVEST CYCLE TIME	70/21	4.4		3.7		3.5	
	80/27	3.9		2.8		3.0	
	90/32	3.7		2.0		2.0	
min.	100/38	3.0		2.0		2.0	
HEAD PRESSURE	70/21	217	<u>15.3</u>	238	<u>16.7</u>	261	<u>18.4</u>
	80/27	233	<u>16.4</u>	265	<u>18.6</u>	286	<u>20.1</u>
	90/32	238	<u>16.7</u>	287	<u>20.2</u>	310	<u>21.8</u>
PSIG kg/cm ² G	100/38	241	<u>16.9</u>	292	<u>20.6</u>	331	<u>23.3</u>
SUCTION PRESSURE	70/21	60	<u>4.2</u>	62	<u>4.4</u>	67	<u>4.7</u>
	80/27	62	<u>4.3</u>	65	<u>4.6</u>	71	<u>5.0</u>
	90/32	62	<u>4.4</u>	67	<u>4.7</u>	73	<u>5.1</u>
PSIG kg/cm ² G	100/38	64	<u>4.5</u>	68	<u>4.8</u>	78	<u>5.5</u>
TOTAL HEAT OF REJECTION FROM CONDENSER	13,000 BTU/h [AT 90°F (32°C) / WT 70°F (21°C)]						
TOTAL HEAT OF REJECTION FROM COMPRESSOR	1,700 BTU/h [AT 90°F (32°C) / WT 70°F (21°C)]						

2. KM-901MWJ

Specification Sheet

AC SUPPLY VOLTAGE	208-230/60/1 (3 WIRE WITH NEUTRAL FOR 115V)	
AMPERAGE	10.0 A	
MINIMUM CIRCUIT AMPACITY	20 A	
MAXIMUM FUSE SIZE	20 A	
ELECTRIC & WATER CONSUMPTION	90/70°F	70/50°F
ELECTRIC W (kWH/100 lbs.)	1350(3.65)	1290(3.36)
WATER gal./24HR (gal./100 lbs.)	156(17.5)	261(28.4)
WATER COOLED CONDENSER	1145(129)	614(67)
gal./24HR (gal./100 lbs.)		
ICE PRODUCTION PER CYCLE	19.6 lbs. (8.9 kg) 960pcs.	
BIN CONTROL SYSTEM	Ultrasonic	
REFRIGERANT CHARGE	R404A, 1 lb. 14 oz. (850g)	

Performance Data Sheet

APPROXIMATE ICE PRODUCTION PER 24 HR.	AMBIENT TEMP. (°F/°C)	WATER TEMP. (°F/°C)					
		50/10		70/21		90/32	
	70/21	919	<u>417</u>	911	<u>413</u>	850	<u>386</u>
	80/27	913	<u>414</u>	900	<u>408</u>	812	<u>368</u>
	90/32	911	<u>413</u>	890	<u>404</u>	813	<u>369</u>
lbs./day <u>kg/day</u>	100/38	882	<u>400</u>	872	<u>396</u>	742	<u>337</u>
APPROXIMATE ELECTRIC CONSUMPTION	70/21	1290		1308		1317	
	80/27	1303		1331		1332	
	90/32	1308		1350		1355	
watts	100/38	1305		1351		1360	
APPROXIMATE WATER CONSUMPTION PER 24 HR.	70/21	876	<u>3.31</u>	1000	<u>3.79</u>	1484	<u>5.62</u>
	80/27	970	<u>3.67</u>	1164	<u>4.41</u>	1821	<u>6.89</u>
	90/32	1000	<u>3.79</u>	1301	<u>4.92</u>	1895	<u>7.17</u>
gal./day <u>m³/day</u>	100/38	1321	<u>5.00</u>	1440	<u>5.45</u>	2441	<u>9.24</u>
FREEZING CYCLE TIME	70/21	27		28		29	
	80/27	28		29		31	
	90/32	28		30		31	
min.	100/38	28		30		33	
HARVEST CYCLE TIME	70/21	4.0		3.6		3.3	
	80/27	3.7		3.0		2.9	
	90/32	3.6		2.6		2.4	
min.	100/38	3.1		2.5		2.2	
HEAD PRESSURE	70/21	227	<u>16.0</u>	229	<u>16.1</u>	240	<u>16.9</u>
	80/27	229	<u>16.1</u>	232	<u>16.3</u>	247	<u>17.4</u>
	90/32	229	<u>16.1</u>	234	<u>16.5</u>	248	<u>17.4</u>
PSIG <u>kg/cm²G</u>	100/38	234	<u>16.4</u>	237	<u>16.7</u>	260	<u>18.3</u>
SUCTION PRESSURE	70/21	56	<u>3.9</u>	57	<u>4.0</u>	59	<u>4.2</u>
	80/27	57	<u>4.0</u>	58	<u>4.1</u>	61	<u>4.3</u>
	90/32	57	<u>4.0</u>	59	<u>4.1</u>	62	<u>4.3</u>
PSIG <u>kg/cm²G</u>	100/38	58	<u>4.1</u>	60	<u>4.2</u>	64	<u>4.5</u>
TOTAL HEAT OF REJECTION FROM CONDENSER	11,810 BTU/h [AT 90°F (32°C) / WT 70°F (21°C)]						
TOTAL HEAT OF REJECTION FROM COMPRESSOR	1,510 BTU/h [AT 90°F (32°C) / WT 70°F (21°C)]						
WATER FLOW FOR CONDENSER	97.5 gal/h [AT 100°F (38°C)/WT 90°F (32°C)]						
PRESSURE DROP OF COOLING WATER LINE	less than 10PSIG						

3. KM-901MRJ(Z) with URC-14F(Z)

Specification Sheet

AC SUPPLY VOLTAGE	208-230/60/1	
AMPERAGE	12 A	
MINIMUM CIRCUIT AMPACITY	20 A	
MAXIMUM FUSE SIZE	20 A	
ELECTRIC & WATER CONSUMPTION	90/70°F	70/50°F
ELECTRIC W (KWH/100 lbs.)	1610 (4.52)	1490 (3.96)
WATER gal./24HR (gal./100 lbs.)	136 (16.0)	271 (30.0)
ICE PRODUCTION PER CYCLE	19.3 lbs. (8.8 kg) 960pcs.	
BIN CONTROL SYSTEM	Ultrasonic	
REFRIGERANT CHARGE	TOTAL R404A, 12 lb. 5.5 oz. (5600g)	
	ICEMAKER, 7 lb. 15 oz. (3600g)	
	CONDENSER, 4 lb. 6.5 oz. (2000g)	

Performance Data Sheet

APPROXIMATE ICE PRODUCTION PER 24 HR.	AMBIENT TEMP. (°F/°C)	WATER TEMP. (°F/°C)					
		50/10		70/21		90/32	
	70/21	904	<u>410</u>	889	<u>403</u>	842	<u>382</u>
	80/27	893	<u>405</u>	869	<u>394</u>	808	<u>366</u>
	90/32	889	<u>403</u>	853	<u>387</u>	797	<u>361</u>
lbs./day kg./day	100/38	871	<u>395</u>	840	<u>381</u>	745	<u>338</u>
APPROXIMATE ELECTRIC CONSUMPTION	70/21	1490		1525		1541	
	80/27	1517		1571		1569	
	90/32	1525		1610		1615	
watts	100/38	1517		1611		1620	
APPROXIMATE WATER CONSUMPTION PER 24 HR.	70/21	271	<u>1.03</u>	232	<u>0.88</u>	209	<u>0.79</u>
	80/27	241	<u>0.91</u>	180	<u>0.68</u>	175	<u>0.66</u>
	90/32	232	<u>0.88</u>	136	<u>0.52</u>	124	<u>0.47</u>
gal./day m ³ /day	100/38	186	<u>0.70</u>	133	<u>0.51</u>	112	<u>0.42</u>
FREEZING CYCLE TIME	70/21	29		30		31	
	80/27	30		31		32	
	90/32	30		32		33	
min.	100/38	30		32		34	
HARVEST CYCLE TIME	70/21	3.9		3.4		3.2	
	80/27	3.5		2.7		2.8	
	90/32	3.4		2.1		2.1	
min.	100/38	2.8		2.1		2.1	
HEAD PRESSURE	70/21	200	<u>14.1</u>	213	<u>14.9</u>	231	<u>16.2</u>
	80/27	210	<u>14.7</u>	229	<u>16.1</u>	248	<u>17.5</u>
	90/32	213	<u>14.9</u>	243	<u>17.1</u>	262	<u>18.4</u>
PSIG kg/cm ² G	100/38	217	<u>15.2</u>	248	<u>17.4</u>	280	<u>19.7</u>
SUCTION PRESSURE	70/21	57	<u>4.0</u>	58	<u>4.1</u>	60	<u>4.3</u>
	80/27	58	<u>4.1</u>	59	<u>4.2</u>	62	<u>4.4</u>
	90/32	58	<u>4.1</u>	60	<u>4.2</u>	63	<u>4.4</u>
PSIG kg/cm ² G	100/38	59	<u>4.1</u>	61	<u>4.3</u>	66	<u>4.6</u>
TOTAL HEAT OF REJECTION FROM CONDENSER	12,500 BTU/h [AT 90°F (32°C) / WT 70°F (21°C)]						
TOTAL HEAT OF REJECTION FROM COMPRESSOR	1,500 BTU/h [AT 90°F (32°C) / WT 70°F (21°C)]						
CONDENSER VOLUME	134 CU. IN. (URC-14-F)						

4. KM-901MRJ(Z)3 with URC-14F(Z)

Specification Sheet

AC SUPPLY VOLTAGE	208-230/60/3	
AMPERAGE	7.1 A	
MINIMUM CIRCUIT AMPACITY	20 A	
MAXIMUM FUSE SIZE	20 A	
ELECTRIC & WATER CONSUMPTION	90/70°F	70/50°F
ELECTRIC W (kWH/100 lbs.)	1520(4.40)	1410(3.65)
WATER gal./24HR (gal./100 lbs.)	125(15.0)	259(28.0)
ICE PRODUCTION PER CYCLE	19 lbs. (8.6 kg) 960pcs.	
BIN CONTROL SYSTEM	Ultrasonic	
REFRIGERANT CHARGE	TOTAL R404A, 12 lb. 5.5 oz. (5600g)	
	ICEMAKER, 7 lb. 15 oz. (3600g)	
	CONDENSER, 4 lb. 6.5 oz. (2000g)	

Performance Data Sheet

APPROXIMATE ICE PRODUCTION PER 24 HR.	AMBIENT TEMP. (°F/°C)	WATER TEMP. (°F/°C)					
		50/10		70/21		90/32	
	70/21	927	<u>420</u>	899	<u>408</u>	852	<u>386</u>
	80/27	905	<u>411</u>	861	<u>391</u>	810	<u>368</u>
	90/32	899	<u>408</u>	830	<u>376</u>	780	<u>354</u>
lbs./day kg./day	100/38	887	<u>402</u>	818	<u>371</u>	734	<u>333</u>
APPROXIMATE ELECTRIC CONSUMPTION	70/21	1410		1442		1468	
	80/27	1435		1485		1501	
	90/32	1442		1520		1541	
watts	100/38	1441		1525		1560	
APPROXIMATE WATER CONSUMPTION PER 24 HR.	70/21	259	<u>0.98</u>	220	<u>0.83</u>	201	<u>0.76</u>
	80/27	229	<u>0.87</u>	168	<u>0.64</u>	169	<u>0.64</u>
	90/32	220	<u>0.83</u>	125	<u>0.47</u>	117	<u>0.44</u>
gal./day m ³ /day	100/38	175	<u>0.66</u>	123	<u>0.46</u>	110	<u>0.42</u>
FREEZING CYCLE TIME	70/21	29		29		30	
	80/27	29		30		31	
	90/32	29		31		32	
min.	100/38	30		31		33	
HARVEST CYCLE TIME	70/21	3.5		3.1		2.9	
	80/27	3.2		2.5		2.6	
	90/32	3.1		2.0		2.0	
min.	100/38	2.6		2.0		2.0	
HEAD PRESSURE	70/21	200	<u>14.1</u>	210	<u>14.8</u>	231	<u>16.2</u>
	80/27	208	<u>14.6</u>	224	<u>15.7</u>	248	<u>17.5</u>
	90/32	210	<u>14.8</u>	235	<u>16.5</u>	258	<u>18.2</u>
PSIG kg/cm ² G	100/38	217	<u>15.2</u>	240	<u>16.9</u>	280	<u>19.7</u>
SUCTION PRESSURE	70/21	55	<u>3.9</u>	56	<u>3.9</u>	59	<u>4.1</u>
	80/27	56	<u>3.9</u>	57	<u>4.0</u>	61	<u>4.3</u>
	90/32	56	<u>3.9</u>	58	<u>4.1</u>	62	<u>4.3</u>
PSIG kg/cm ² G	100/38	57	<u>4.0</u>	59	<u>4.1</u>	65	<u>4.6</u>
TOTAL HEAT OF REJECTION FROM CONDENSER	12,000 BTU/h [AT 90°F (32°C) / WT 70°F (21°C)]						
TOTAL HEAT OF REJECTION FROM COMPRESSOR	1,400 BTU/h [AT 90°F (32°C) / WT 70°F (21°C)]						
CONDENSER VOLUME	129 CU. IN						

5. KM-1100MAJ

Specification Sheet

AC SUPPLY VOLTAGE	208-230/60/1	
AMPERAGE	12.5 A	
MINIMUM CIRCUIT AMPACITY	20 A	
MAXIMUM FUSE SIZE	20 A	
ELECTRIC & WATER CONSUMPTION	90/70°F	70/50°F
ELECTRIC W (kWH/100 lbs.)	1910 (4.90)	1810 (4.00)
WATER gal./24HR (gal./100 lbs.)	178 (19.0)	467 (43.0)
ICE PRODUCTION PER CYCLE	20.7 lbs. (9.4 kg) 960pcs.	
BIN CONTROL SYSTEM	Ultrasonic	
REFRIGERANT CHARGE	R404A, 3 lb. 1.4 oz. (1400g)	

Performance Data Sheet

APPROXIMATE ICE PRODUCTION PER 24 HR.	AMBIENT TEMP. (°F/°C)	WATER TEMP. (°F/°C)					
		50/10		70/21		90/32	
	70/21	1087	<u>493</u>	1042	<u>473</u>	954	<u>433</u>
	80/27	1053	<u>478</u>	984	<u>446</u>	880	<u>399</u>
	90/32	1042	<u>473</u>	935	<u>424</u>	836	<u>379</u>
lbs./day <u>kg./day</u>	100/38	1016	<u>461</u>	912	<u>414</u>	745	<u>338</u>
APPROXIMATE ELECTRIC CONSUMPTION	70/21	1810		1839		1736	
	80/27	1832		1878		1695	
	90/32	1839		1910		1759	
watts	100/38	1770		1875		1620	
APPROXIMATE WATER CONSUMPTION PER 24 HR.	70/21	467	<u>1.77</u>	383	<u>1.45</u>	329	<u>1.25</u>
	80/27	403	<u>1.52</u>	271	<u>1.03</u>	252	<u>0.96</u>
	90/32	383	<u>1.45</u>	178	<u>0.67</u>	143	<u>0.54</u>
gal./day <u>m³/day</u>	100/38	281	<u>1.07</u>	170	<u>0.64</u>	112	<u>0.42</u>
FREEZING CYCLE TIME	70/21	24		26		29	
	80/27	26		28		31	
	90/32	26		30		33	
min.	100/38	27		31		35	
HARVEST CYCLE TIME	70/21	3.1		2.8		2.7	
	80/27	2.8		2.4		2.5	
	90/32	2.8		2.0		2.0	
min.	100/38	2.4		2.0		2.1	
HEAD PRESSURE	70/21	242	<u>17.0</u>	259	<u>18.2</u>	288	<u>20.2</u>
	80/27	255	<u>17.9</u>	281	<u>19.8</u>	313	<u>22.0</u>
	90/32	259	<u>18.2</u>	300	<u>21.1</u>	331	<u>23.3</u>
PSIG <u>kg/cm²G</u>	100/38	267	<u>18.7</u>	307	<u>21.6</u>	360	<u>25.3</u>
SUCTION PRESSURE	70/21	52	<u>3.7</u>	54	<u>3.8</u>	58	<u>4.1</u>
	80/27	54	<u>3.8</u>	57	<u>4.0</u>	62	<u>4.3</u>
	90/32	54	<u>3.8</u>	59	<u>4.1</u>	64	<u>4.5</u>
PSIG <u>kg/cm²G</u>	100/38	55	<u>3.9</u>	60	<u>4.2</u>	68	<u>4.8</u>
TOTAL HEAT OF REJECTION FROM CONDENSER	15,700 BTU/h [AT 90°F (32°C) / WT 70°F (21°C)]						
TOTAL HEAT OF REJECTION FROM COMPRESSOR	2,300 BTU/h [AT 90°F (32°C) / WT 70°F (21°C)]						

6. KM-1100MWJ

Specification Sheet

AC SUPPLY VOLTAGE	208-230/60/1	
AMPERAGE	9.6 A	
MINIMUM CIRCUIT AMPACITY	20 A	
MAXIMUM FUSE SIZE	20 A	
ELECTRIC & WATER CONSUMPTION	90/70°F	70/50°F
ELECTRIC W (kWH/100 lbs.)	1680 (4.00)	1610 (3.60)
WATER gal./24HR (gal./100 lbs.)	201 (20.0)	395 (36.8)
WATER COOLED CONDENSER	1076 (107)	653 (61)
gal./24HR (gal./100 lbs.)		
ICE PRODUCTION PER CYCLE	20.7 lbs. (9.4 kg) 960pcs.	
BIN CONTROL SYSTEM	Ultrasonic	
REFRIGERANT CHARGE	R404A, 1 lb. 10.5 oz. (750g)	

Performance Data Sheet

APPROXIMATE ICE PRODUCTION PER 24 HR.	AMBIENT TEMP. (°F/°C)	WATER TEMP. (°F/°C)					
		50/10		70/21		90/32	
	70/21	1073	<u>487</u>	1054	<u>478</u>	1008	<u>457</u>
	80/27	1058	<u>480</u>	1028	<u>466</u>	972	<u>441</u>
	90/32	1054	<u>478</u>	1006	<u>456</u>	954	<u>433</u>
lbs./day kg./day	100/38	1038	<u>471</u>	994	<u>451</u>	906	<u>411</u>
APPROXIMATE ELECTRIC CONSUMPTION	70/21	1610		1631		1661	
	80/27	1626		1658		1689	
	90/32	1631		1680		1711	
watts	100/38	1637		1687		1740	
APPROXIMATE WATER CONSUMPTION PER 24 HR.	70/21	1048	<u>3.97</u>	1115	<u>4.22</u>	1538	<u>5.82</u>
	80/27	1099	<u>4.16</u>	1204	<u>4.56</u>	1811	<u>6.85</u>
	90/32	1115	<u>4.22</u>	1278	<u>4.84</u>	1816	<u>6.87</u>
gal./day m ³ /day	100/38	1357	<u>5.14</u>	1404	<u>5.31</u>	2310	<u>8.75</u>
FREEZING CYCLE TIME	70/21	24		24		25	
	80/27	24		25		26	
	90/32	24		26		27	
min.	100/38	25		26		28	
HARVEST CYCLE TIME	70/21	3.2		2.9		2.7	
	80/27	2.9		2.4		2.5	
	90/32	2.9		2.0		2.0	
min.	100/38	2.5		2.0		2.0	
HEAD PRESSURE	70/21	243	<u>17.1</u>	246	<u>17.3</u>	255	<u>18.0</u>
	80/27	245	<u>17.2</u>	250	<u>17.6</u>	262	<u>18.4</u>
	90/32	246	<u>17.3</u>	253	<u>17.8</u>	264	<u>18.6</u>
PSIG kg/cm ² G	100/38	250	<u>17.6</u>	256	<u>18.0</u>	275	<u>19.3</u>
SUCTION PRESSURE	70/21	51	<u>3.6</u>	52	<u>3.7</u>	58	<u>4.1</u>
	80/27	52	<u>3.6</u>	54	<u>3.8</u>	62	<u>4.4</u>
	90/32	52	<u>3.7</u>	55	<u>3.9</u>	62	<u>4.4</u>
PSIG kg/cm ² G	100/38	55	<u>3.8</u>	57	<u>4.0</u>	69	<u>4.9</u>
TOTAL HEAT OF REJECTION FROM CONDENSER	17,100 BTU/h [AT 90°F (32°C) / WT 70°F (21°C)]						
TOTAL HEAT OF REJECTION FROM COMPRESSOR	2,200 BTU/h [AT 90°F (32°C) / WT 70°F (21°C)]						
WATER FLOW FOR CONDENSER	91 gal./h [AT 100°F (38°C) / WT 90°F (32°C)]						
PRESSURE DROP OF COOLING WATER LINE	less than 10 PSIG						

7. KM-1100MRJ(Z) with URC-14F(Z)

Specification Sheet

AC SUPPLY VOLTAGE	208-230/60/1	
AMPERAGE	12.5 A	
MINIMUM CIRCUIT AMPACITY	20 A	
MAXIMUM FUSE SIZE	20 A	
ELECTRIC & WATER CONSUMPTION	90/70°F	70/50°F
ELECTRIC W (kWH/100 lbs.)	1930 (4.50)	1840 (3.82)
WATER gal./24HR (gal./100 lbs.)	185 (18.0)	451 (39.0)
ICE PRODUCTION PER CYCLE	20.7 lbs. (9.4 kg) 960pcs.	
BIN CONTROL SYSTEM	Ultrasonic	
REFRIGERANT CHARGE	TOTAL R404A, 9 lb. 11.2 oz. (4400g)	
	ICEMAKER, 5 lb. 4.7 oz. (2400g)	
	CONDENSER, 4 lb. 6.5 oz. (2000g)	

Performance Data Sheet

APPROXIMATE ICE PRODUCTION PER 24 HR.	AMBIENT TEMP. (°F/°C)	WATER TEMP. (°F/°C)					
		50/10		70/21		90/32	
	70/21	1156	<u>524</u>	1119	<u>508</u>	1045	<u>474</u>
	80/27	1128	<u>512</u>	1070	<u>486</u>	983	<u>446</u>
	90/32	1119	<u>508</u>	1030	<u>467</u>	947	<u>429</u>
lbs./day <u>kg./day</u>	100/38	1096	<u>497</u>	1010	<u>458</u>	870	<u>395</u>
APPROXIMATE ELECTRIC CONSUMPTION	70/21	1840		1866		1902	
	80/27	1860		1901		1937	
	90/32	1866		1930		1966	
watts	100/38	1873		1939		2000	
APPROXIMATE WATER CONSUMPTION PER 24 HR.	70/21	451	<u>1.71</u>	373	<u>1.41</u>	326	<u>1.24</u>
	80/27	392	<u>1.48</u>	271	<u>1.02</u>	257	<u>0.97</u>
	90/32	373	<u>1.41</u>	185	<u>0.70</u>	157	<u>0.59</u>
gal./day <u>m³/day</u>	100/38	281	<u>1.06</u>	179	<u>0.68</u>	131	<u>0.49</u>
FREEZING CYCLE TIME	70/21	22		23		25	
	80/27	22		24		27	
	90/32	23		26		28	
min.	100/38	23		26		30	
HARVEST CYCLE TIME	70/21	3.4		3.0		2.9	
	80/27	3.1		2.5		2.6	
	90/32	3.0		2.0		2.0	
min.	100/38	2.6		2.0		2.0	
HEAD PRESSURE	70/21	202	<u>14.2</u>	217	<u>15.3</u>	240	<u>16.9</u>
	80/27	213	<u>15.0</u>	237	<u>16.6</u>	261	<u>18.4</u>
	90/32	217	<u>15.3</u>	253	<u>17.8</u>	277	<u>19.5</u>
PSIG <u>kg/cm²G</u>	100/38	222	<u>15.6</u>	259	<u>18.2</u>	300	<u>21.1</u>
SUCTION PRESSURE	70/21	49	<u>3.4</u>	50	<u>3.5</u>	56	<u>3.9</u>
	80/27	50	<u>3.5</u>	52	<u>3.6</u>	59	<u>4.2</u>
	90/32	50	<u>3.5</u>	53	<u>3.7</u>	60	<u>4.2</u>
PSIG <u>kg/cm²G</u>	100/38	53	<u>3.7</u>	55	<u>3.8</u>	66	<u>4.6</u>
TOTAL HEAT OF REJECTION FROM CONDENSER	15,600 BTU/h [AT 90°F (32°C) / WT 70°F (21°C)]						
TOTAL HEAT OF REJECTION FROM COMPRESSOR	2,200 BTU/h [AT 90°F (32°C) / WT 70°F (21°C)]						
CONDENSER VOLUME	134 CU. IN. (URC-14F)						

8. KM-1340MAJ

Specification Sheet

AC SUPPLY VOLTAGE	208-230/60/1 (3 WIRE WITH NEUTRAL FOR 115V)	
AMPERAGE	13.2 A	
MINIMUM CIRCUIT AMPACITY	20 A	
MAXIMUM FUSE SIZE	20 A	
ELECTRIC & WATER CONSUMPTION	90/70°F	70/50°F
ELECTRIC W (kWH/100 lbs.)	2050 (4.20)	1960 (3.62)
WATER gal./24HR (gal./100 lbs.)	200 (17.0)	585 (45.2)
ICE PRODUCTION PER CYCLE	31.8 lbs. (14.4 kg) 1440pcs.	
BIN CONTROL SYSTEM	Ultrasonic	
REFRIGERANT CHARGE	R404A, 4 lb. 10.1 oz. (2100g)	

Performance Data Sheet

APPROXIMATE ICE PRODUCTION PER 24 HR.	AMBIENT TEMP. (°F/°C)	WATER TEMP. (°F/°C)					
		50/10		70/21		90/32	
	70/21	1296	<u>588</u>	1260	<u>572</u>	1181	<u>536</u>
	80/27	1269	<u>575</u>	1214	<u>551</u>	1117	<u>507</u>
	90/32	1260	<u>572</u>	1175	<u>533</u>	1084	<u>492</u>
lbs./day <u>kg./day</u>	100/38	1234	<u>560</u>	1153	<u>523</u>	1000	<u>454</u>
APPROXIMATE ELECTRIC CONSUMPTION	70/21	1960		1986		2030	
	80/27	1980		2021		2069	
	90/32	1986		2050		2097	
watts	100/38	1998		2061		2140	
APPROXIMATE WATER CONSUMPTION PER 24 HR.	70/21	585	<u>2.21</u>	472	<u>1.79</u>	420	<u>1.59</u>
	80/27	499	<u>1.89</u>	324	<u>1.23</u>	328	<u>1.24</u>
	90/32	472	<u>1.79</u>	200	<u>0.76</u>	179	<u>0.68</u>
gal./day <u>m³/day</u>	100/38	346	<u>1.31</u>	195	<u>0.74</u>	160	<u>0.61</u>
FREEZING CYCLE TIME	70/21	30		32		34	
	80/27	31		34		36	
	90/32	32		36		38	
min.	100/38	32		36		40	
HARVEST CYCLE TIME	70/21	5.0		4.2		3.9	
	80/27	4.4		3.0		3.2	
	90/32	4.2		2.1		2.1	
min.	100/38	3.2		2.1		2.0	
HEAD PRESSURE	70/21	230	<u>16.2</u>	246	<u>17.3</u>	272	<u>19.1</u>
	80/27	242	<u>17.0</u>	266	<u>18.7</u>	296	<u>20.8</u>
	90/32	246	<u>17.3</u>	283	<u>19.9</u>	312	<u>21.9</u>
PSIG <u>kg/cm²G</u>	100/38	253	<u>17.8</u>	290	<u>20.4</u>	339	<u>23.8</u>
SUCTION PRESSURE	70/21	50	<u>3.5</u>	51	<u>3.6</u>	54	<u>3.8</u>
	80/27	51	<u>3.6</u>	53	<u>3.7</u>	57	<u>4.0</u>
	90/32	51	<u>3.6</u>	54	<u>3.8</u>	58	<u>4.1</u>
PSIG <u>kg/cm²G</u>	100/38	52	<u>3.7</u>	55	<u>3.9</u>	61	<u>4.3</u>
TOTAL HEAT OF REJECTION FROM CONDENSER	21,000 BTU/h [AT 90°F (32°C) / WT 70°F (21°C)]						
TOTAL HEAT OF REJECTION FROM COMPRESSOR	2,800 BTU/h [AT 90°F (32°C) / WT 70°F (21°C)]						

9. KM-1340MWJ

Specification Sheet

AC SUPPLY VOLTAGE	208-230/60/1 (3 WIRE WITH NEUTRAL FOR 115V)	
AMPERAGE	11.0 A	
MINIMUM CIRCUIT AMPACITY	20 A	
MAXIMUM FUSE SIZE	20 A	
ELECTRIC & WATER CONSUMPTION	90/70°F	70/50°F
ELECTRIC W (kWH/100 lbs.)	1920 (3.60)	1820 (3.31)
WATER gal./24HR (gal./100 lbs.)	228 (17.8)	443 (33.5)
WATER COOLED CONDENSER gal./24HR (gal./100 lbs.)	1645(129)	835(63)
ICE PRODUCTION PER CYCLE	29.4 lbs. (13.3 kg) 1440pcs.	
BIN CONTROL SYSTEM	Ultrasonic	
REFRIGERANT CHARGE	R404A, 2 lb. 1.5 oz. (950g)	

Performance Data Sheet

APPROXIMATE ICE PRODUCTION PER 24 HR.	AMBIENT TEMP. (°F/°C)	WATER TEMP. (°F/°C)					
		50/10		70/21		90/32	
	70/21	1323	<u>600</u>	1310	<u>594</u>	1236	<u>561</u>
	80/27	1313	<u>596</u>	1294	<u>587</u>	1188	<u>539</u>
	90/32	1310	<u>594</u>	1280	<u>581</u>	1186	<u>538</u>
lbs./day kg./day	100/38	1276	<u>579</u>	1258	<u>571</u>	1100	<u>499</u>
APPROXIMATE ELECTRIC CONSUMPTION	70/21	1820		1849		1987	
	80/27	1842		1888		2080	
	90/32	1849		1920		2092	
watts	100/38	1910		1960		2250	
APPROXIMATE WATER CONSUMPTION PER 24 HR.	70/21	1278	<u>4.84</u>	1452	<u>5.50</u>	1935	<u>7.33</u>
	80/27	1411	<u>5.34</u>	1682	<u>6.37</u>	2301	<u>8.71</u>
	90/32	1452	<u>5.50</u>	1873	<u>7.09</u>	2445	<u>9.25</u>
gal./day m ³ /day	100/38	1819	<u>6.89</u>	2007	<u>7.60</u>	2970	<u>11.24</u>
FREEZING CYCLE TIME	70/21	29		29		32	
	80/27	29		30		33	
	90/32	29		30		33	
min.	100/38	30		31		36	
HARVEST CYCLE TIME	70/21	3.8		3.3		3.1	
	80/27	3.5		2.7		2.7	
	90/32	3.3		2.2		2.1	
min.	100/38	2.8		2.2		2.1	
HEAD PRESSURE	70/21	229	<u>16.1</u>	232	<u>16.3</u>	248	<u>17.4</u>
	80/27	231	<u>16.2</u>	235	<u>16.5</u>	259	<u>18.2</u>
	90/32	232	<u>16.3</u>	238	<u>16.7</u>	259	<u>18.2</u>
PSIG kg/cm ² G	100/38	239	<u>16.8</u>	243	<u>17.1</u>	278	<u>19.5</u>
SUCTION PRESSURE	70/21	47	<u>3.3</u>	48	<u>3.3</u>	50	<u>3.5</u>
	80/27	47	<u>3.3</u>	48	<u>3.4</u>	52	<u>3.6</u>
	90/32	48	<u>3.3</u>	49	<u>3.4</u>	52	<u>3.7</u>
PSIG kg/cm ² G	100/38	49	<u>3.4</u>	50	<u>3.5</u>	55	<u>3.9</u>
TOTAL HEAT OF REJECTION FROM CONDENSER	18,500 BTU/h [AT 90°F (32°C) / WT 70°F (21°C)]						
TOTAL HEAT OF REJECTION FROM COMPRESSOR	2,400 BTU/h [AT 90°F (32°C) / WT 70°F (21°C)]						
WATER FLOW FOR CONDENSER	116.9 gal/h [AT 100°F (38°C)/WT 90°F (32°C)]						
PRESSURE DROP OF COOLING WATER LINE	less than 10PSIG						

10. KM-1340MRJ(Z) with URC-14F(Z)

Specification Sheet

AC SUPPLY VOLTAGE	208-230/60/1 (3 WIRE WITH NEUTRAL FOR 115V)	
AMPERAGE	14.0 A	
MINIMUM CIRCUIT AMPACITY	20 A	
MAXIMUM FUSE SIZE	20 A	
ELECTRIC & WATER CONSUMPTION	90/70°F	70/50°F
ELECTRIC W (kWH/100 lbs.)	2230 (4.54)	2070 (3.62)
WATER gal./24HR (gal./100 lbs.)	206 (17.5)	554 (40.4)
ICE PRODUCTION PER CYCLE	30.6 lbs. (13.9 kg) 1440pcs.	
BIN CONTROL SYSTEM	Ultrasonic	
REFRIGERANT CHARGE	TOTAL R404A, 11 lb. 0.4 oz. (5000g)	
	ICEMAKER, 6 lb. 9.8 oz. (3000g)	
	CONDENSER, 4 lb. 6.5 oz. (2000g)	

Performance Data Sheet

APPROXIMATE ICE PRODUCTION PER 24 HR.	AMBIENT TEMP. (°F/°C)	WATER TEMP. (°F/°C)					
		50/10		70/21		90/32	
	70/21	1371	<u>622</u>	1314	<u>596</u>	1231	<u>558</u>
	80/27	1328	<u>602</u>	1239	<u>562</u>	1153	<u>523</u>
	90/32	1314	<u>596</u>	1177	<u>534</u>	1090	<u>494</u>
lbs./day <u>kg./day</u>	100/38	1296	<u>588</u>	1157	<u>525</u>	1010	<u>458</u>
APPROXIMATE ELECTRIC CONSUMPTION	70/21	2070		2117		2132	
	80/27	2106		2179		2167	
	90/32	2117		2230		2230	
watts	100/38	2103		2230		2230	
APPROXIMATE WATER CONSUMPTION PER 24 HR.	70/21	554	<u>2.10</u>	452	<u>1.71</u>	398	<u>1.50</u>
	80/27	476	<u>1.80</u>	318	<u>1.20</u>	311	<u>1.18</u>
	90/32	452	<u>1.71</u>	206	<u>0.78</u>	178	<u>0.67</u>
gal./day <u>m³/day</u>	100/38	335	<u>1.27</u>	199	<u>0.75</u>	152	<u>0.57</u>
FREEZING CYCLE TIME	70/21	28		30		31	
	80/27	29		32		33	
	90/32	30		34		35	
min.	100/38	30		34		36	
HARVEST CYCLE TIME	70/21	4.7		4.0		3.7	
	80/27	4.2		3.1		3.1	
	90/32	4.0		2.3		2.2	
min.	100/38	3.2		2.3		2.1	
HEAD PRESSURE	70/21	203	<u>14.3</u>	221	<u>15.5</u>	242	<u>17.0</u>
	80/27	217	<u>15.2</u>	245	<u>17.2</u>	264	<u>18.6</u>
	90/32	221	<u>15.5</u>	265	<u>18.6</u>	285	<u>20.1</u>
PSIG <u>kg/cm²G</u>	100/38	224	<u>15.8</u>	270	<u>19.0</u>	304	<u>21.4</u>
SUCTION PRESSURE	70/21	47	<u>3.3</u>	50	<u>3.5</u>	51	<u>3.6</u>
	80/27	49	<u>3.4</u>	53	<u>3.7</u>	54	<u>3.8</u>
	90/32	50	<u>3.5</u>	56	<u>3.9</u>	57	<u>4.0</u>
PSIG <u>kg/cm²G</u>	100/38	49	<u>3.5</u>	56	<u>4.0</u>	58	<u>4.1</u>
TOTAL HEAT OF REJECTION FROM CONDENSER	19,900 BTU/h [AT 90°F (32°C) / WT 70°F (21°C)]						
TOTAL HEAT OF REJECTION FROM COMPRESSOR	2,600 BTU/h [AT 90°F (32°C) / WT 70°F (21°C)]						
CONDENSER VOLUME	134 CU. IN. (URC-14-FZ)						

11. KM-1340MRJ(Z)3 with URC-14F(Z)

Specification Sheet

AC SUPPLY VOLTAGE	208-230/60/3	
AMPERAGE	12.5 A	
MINIMUM CIRCUIT AMPACITY	20 A	
MAXIMUM FUSE SIZE	20 A	
ELECTRIC & WATER CONSUMPTION	90/70°F	70/50°F
ELECTRIC W (kWH/100 lbs.)	2170 (4.12)	1980 (3.33)
WATER gal./24HR (gal./100 lbs.)	233 (18.4)	507 (35.5)
ICE PRODUCTION PER CYCLE	30.4 lbs. (13.8 kg) 1440pcs.	
BIN CONTROL SYSTEM	Ultrasonic	
REFRIGERANT CHARGE	TOTAL R404A, 11 lb. 0.4 oz. (5000g)	
	ICEMAKER, 6 lb. 9.8 oz. (3000g)	
	CONDENSER, 4 lb. 6.5 oz. (2000g)	

Performance Data Sheet

APPROXIMATE ICE PRODUCTION PER 24 HR.	AMBIENT TEMP. (°F/°C)	WATER TEMP. (°F/°C)					
		50/10		70/21		90/32	
	70/21	1428	<u>648</u>	1381	<u>626</u>	1260	<u>571</u>
	80/27	1392	<u>631</u>	1318	<u>598</u>	1166	<u>529</u>
	90/32	1381	<u>626</u>	1266	<u>574</u>	1125	<u>510</u>
lbs./day kg./day	100/38	1338	<u>607</u>	1233	<u>559</u>	995	<u>451</u>
APPROXIMATE ELECTRIC CONSUMPTION	70/21	1980		2042		2065	
	80/27	2027		2123		2113	
	90/32	2042		2190		2195	
watts	100/38	2026		2191		2200	
APPROXIMATE WATER CONSUMPTION PER 24 HR.	70/21	507	<u>1.92</u>	423	<u>1.60</u>	368	<u>1.39</u>
	80/27	443	<u>1.68</u>	313	<u>1.19</u>	291	<u>1.10</u>
	90/32	423	<u>1.60</u>	222	<u>0.84</u>	184	<u>0.70</u>
gal./day m ³ /day	100/38	323	<u>1.22</u>	213	<u>0.81</u>	149	<u>0.56</u>
FREEZING CYCLE TIME	70/21	28		29		31	
	80/27	29		30		33	
	90/32	29		31		34	
min.	100/38	30		32		36	
HARVEST CYCLE TIME	70/21	4.3		3.6		3.4	
	80/27	3.8		2.8		2.9	
	90/32	3.6		2.0		2.0	
min.	100/38	2.9		2.0		2.0	
HEAD PRESSURE	70/21	209	<u>14.7</u>	225	<u>15.8</u>	252	<u>17.7</u>
	80/27	222	<u>15.6</u>	247	<u>17.4</u>	276	<u>19.4</u>
	90/32	225	<u>15.8</u>	265	<u>18.6</u>	294	<u>20.6</u>
PSIG kg/cm ² G	100/38	232	<u>16.3</u>	272	<u>19.1</u>	320	<u>22.5</u>
SUCTION PRESSURE	70/21	49	<u>3.4</u>	50	<u>3.5</u>	55	<u>3.9</u>
	80/27	50	<u>3.5</u>	51	<u>3.6</u>	58	<u>4.1</u>
	90/32	50	<u>3.5</u>	52	<u>3.7</u>	58	<u>4.1</u>
PSIG kg/cm ² G	100/38	52	<u>3.7</u>	53	<u>3.8</u>	64	<u>4.5</u>
TOTAL HEAT OF REJECTION FROM CONDENSER	18,000 BTU/h [AT 90°F (32°C) / WT 70°F (21°C)]						
TOTAL HEAT OF REJECTION FROM COMPRESSOR	2,400 BTU/h [AT 90°F (32°C) / WT 70°F (21°C)]						
CONDENSER VOLUME	134 CU. IN. (URC-14F)						

12. KM-1601MRJ(Z) with URC-22F(Z)

Specification Sheet

AC SUPPLY VOLTAGE	208-230/60/1	
AMPERAGE	15.9 A	
MINIMUM CIRCUIT AMPACITY	20 A	
MAXIMUM FUSE SIZE	20 A	
ELECTRIC & WATER CONSUMPTION	90/70°F	70/50°F
ELECTRIC W (kWH/100 lbs.)	2810 (4.35)	2560 (3.85)
WATER gal./24HR (gal./100 lbs.)	293 (18.9)	729 (45.7)
ICE PRODUCTION PER CYCLE	29.9 lbs. (13.6 kg) 1440pcs.	
BIN CONTROL SYSTEM	Ultrasonic	
REFRIGERANT CHARGE	TOTAL R404A, 15 lb. 14 oz. (7200g)	
	ICEMAKER, 8 lb. 2.5 oz. (3700g)	
	CONDENSER, 7 lb. 11.5 oz. (3500g)	

Performance Data Sheet

APPROXIMATE ICE PRODUCTION PER 24 HR.	AMBIENT TEMP. (°F/°C)	WATER TEMP. (°F/°C)					
		50/10		70/21		90/32	
	70/21	1594	<u>723</u>	1581	<u>717</u>	1569	<u>712</u>
	80/27	1584	<u>719</u>	1564	<u>709</u>	1555	<u>705</u>
	90/32	1581	<u>717</u>	1550	<u>703</u>	1540	<u>698</u>
lbs./day kg./day	100/38	1581	<u>717</u>	1548	<u>702</u>	1530	<u>694</u>
APPROXIMATE ELECTRIC CONSUMPTION	70/21	2560		2633		2680	
	80/27	2616		2730		2747	
	90/32	2633		2810		2841	
watts	100/38	2625		2817		2870	
APPROXIMATE WATER CONSUMPTION PER 24 HR.	70/21	729	<u>2.76</u>	597	<u>2.26</u>	541	<u>2.05</u>
	80/27	628	<u>2.38</u>	424	<u>1.60</u>	436	<u>1.65</u>
	90/32	597	<u>2.26</u>	279	<u>1.06</u>	261	<u>0.99</u>
gal./day m ³ /day	100/38	451	<u>1.71</u>	275	<u>1.04</u>	245	<u>0.93</u>
FREEZING CYCLE TIME	70/21	23		23		25	
	80/27	23		25		27	
	90/32	23		25		28	
min.	100/38	24		26		30	
HARVEST CYCLE TIME	70/21	5.0		4.2		4.0	
	80/27	4.4		3.2		3.5	
	90/32	4.2		2.4		2.5	
min.	100/38	3.4		2.4		2.6	
HEAD PRESSURE	70/21	217	<u>15.3</u>	233	<u>16.4</u>	259	<u>18.2</u>
	80/27	229	<u>16.1</u>	254	<u>17.8</u>	282	<u>19.8</u>
	90/32	233	<u>16.4</u>	271	<u>19.1</u>	299	<u>21.0</u>
PSIG kg/cm ² G	100/38	240	<u>16.8</u>	278	<u>19.5</u>	325	<u>22.9</u>
SUCTION PRESSURE	70/21	48	<u>3.4</u>	49	<u>3.4</u>	49	<u>3.5</u>
	80/27	48	<u>3.4</u>	49	<u>3.5</u>	50	<u>3.5</u>
	90/32	49	<u>3.4</u>	50	<u>3.5</u>	51	<u>3.6</u>
PSIG kg/cm ² G	100/38	49	<u>3.4</u>	50	<u>3.5</u>	51	<u>3.6</u>
TOTAL HEAT OF REJECTION FROM CONDENSER	24,300 BTU/h [AT 90°F (32°C) / WT 70°F (21°C)]						
TOTAL HEAT OF REJECTION FROM COMPRESSOR	3,600 BTU/h [AT 90°F (32°C) / WT 70°F (21°C)]						
CONDENSER VOLUME	209 CU. IN. (URC-22FZ)						

13. KM-1601MRJ(Z)3 with URC-22F(Z)

Specification Sheet

AC SUPPLY VOLTAGE	208-230/60/3	
AMPERAGE	12.9 A (5 Min. Freeze AT 104°F / WT 80°F)	
MINIMUM CIRCUIT AMPACITY	20 A	
MAXIMUM FUSE SIZE	20 A	
ELECTRIC & WATER CONSUMPTION	90/70°F	70/50°F
ELECTRIC W (kWH/100 lbs.)	2640 (4.09)	2550 (3.70)
WATER gal./24HR (gal./100 lbs.)	293 (18.9)	579 (35.0)
ICE PRODUCTION PER CYCLE	29.9 lbs. (13.5 kg) 1440pcs.	
BIN CONTROL SYSTEM	Ultrasonic	
REFRIGERANT CHARGE	TOTAL R404A, 15 lb. 14 oz. (7200g)	
	ICEMAKER, 8 lb. 2.5 oz. (3700g)	
	CONDENSER, 7 lb. 11.5 oz. (3500g)	

Performance Data Sheet

APPROXIMATE ICE PRODUCTION PER 24 HR.	AMBIENT TEMP. (°F/°C)	WATER TEMP. (°F/°C)					
		50/10		70/21		90/32	
	70/21	1653	<u>750</u>	1623	<u>736</u>	1597	<u>725</u>
	80/27	1630	<u>739</u>	1583	<u>718</u>	1567	<u>711</u>
	90/32	1623	<u>736</u>	1550	<u>703</u>	1529	<u>694</u>
lbs./day kg./day	100/38	1623	<u>736</u>	1545	<u>701</u>	1510	<u>685</u>
APPROXIMATE ELECTRIC CONSUMPTION	70/21	2550		2576		2612	
	80/27	2570		2611		2647	
	90/32	2576		2640		2676	
watts	100/38	2583		2649		2710	
APPROXIMATE WATER CONSUMPTION PER 24 HR.	70/21	579	<u>2.19</u>	491	<u>1.86</u>	448	<u>1.69</u>
	80/27	512	<u>1.94</u>	375	<u>1.42</u>	375	<u>1.42</u>
	90/32	491	<u>1.86</u>	279	<u>1.06</u>	260	<u>0.98</u>
gal./day m ³ /day	100/38	391	<u>1.48</u>	274	<u>1.04</u>	242	<u>0.91</u>
FREEZING CYCLE TIME	70/21	23		23		26	
	80/27	23		24		27	
	90/32	23		25		28	
min.	100/38	24		26		30	
HARVEST CYCLE TIME	70/21	5.0		4.2		3.8	
	80/27	4.4		3.2		3.2	
	90/32	4.2		2.4		2.2	
min.	100/38	3.3		2.3		2.1	
HEAD PRESSURE	70/21	210	<u>14.8</u>	213	<u>15.0</u>	220	<u>15.4</u>
	80/27	212	<u>14.9</u>	217	<u>15.2</u>	225	<u>15.8</u>
	90/32	213	<u>15.0</u>	220	<u>15.5</u>	228	<u>16.0</u>
PSIG kg/cm ² G	100/38	215	<u>15.1</u>	222	<u>15.6</u>	235	<u>16.5</u>
SUCTION PRESSURE	70/21	47	<u>3.3</u>	46	<u>3.3</u>	48	<u>3.4</u>
	80/27	47	<u>3.3</u>	46	<u>3.2</u>	49	<u>3.4</u>
	90/32	46	<u>3.3</u>	45	<u>3.2</u>	48	<u>3.3</u>
PSIG kg/cm ² G	100/38	48	<u>3.3</u>	46	<u>3.2</u>	50	<u>3.5</u>
TOTAL HEAT OF REJECTION FROM CONDENSER	23,300 BTU/h [AT 90°F (32°C) / WT 70°F (21°C)]						
TOTAL HEAT OF REJECTION FROM COMPRESSOR	3,700 BTU/h [AT 90°F (32°C) / WT 70°F (21°C)]						
CONDENSER VOLUME	209 CU. IN. (URC-22FZ)						

B. Wiring Diagrams

1. Auxilary Code: P-2 and Earlier

a) KM-901M_J(Z), KM-1100M_J(Z) Thermostatic Bin Control

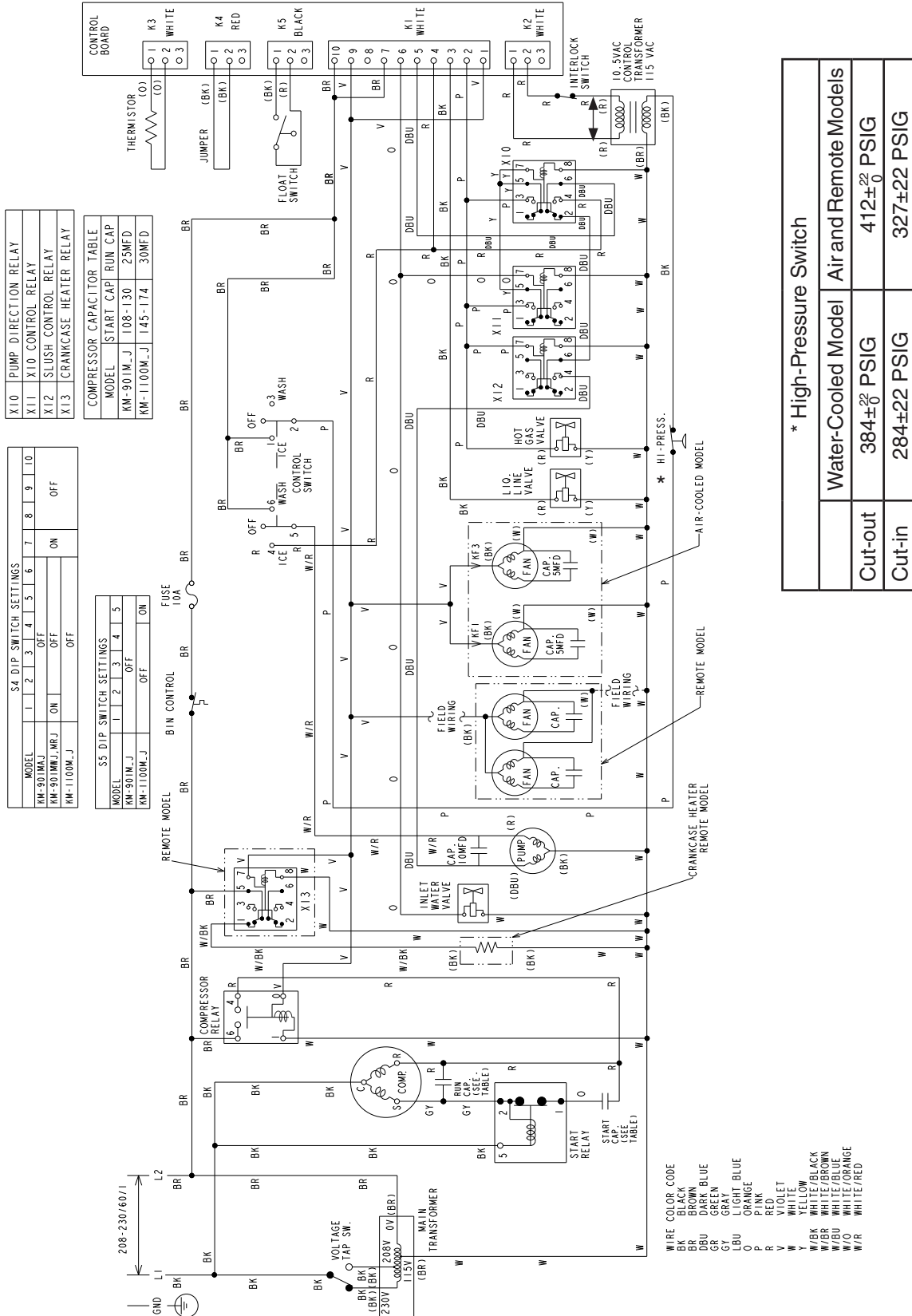

* High-Pressure Switch		
Water-Cooled Model	Air and Remote Models	
Cut-out	384±20 PSIG	412±20 PSIG
Cut-in	284±22 PSIG	327±22 PSIG

b) KM-901M_J(Z), KM-1100M_J(Z) Mechanical Bin Control

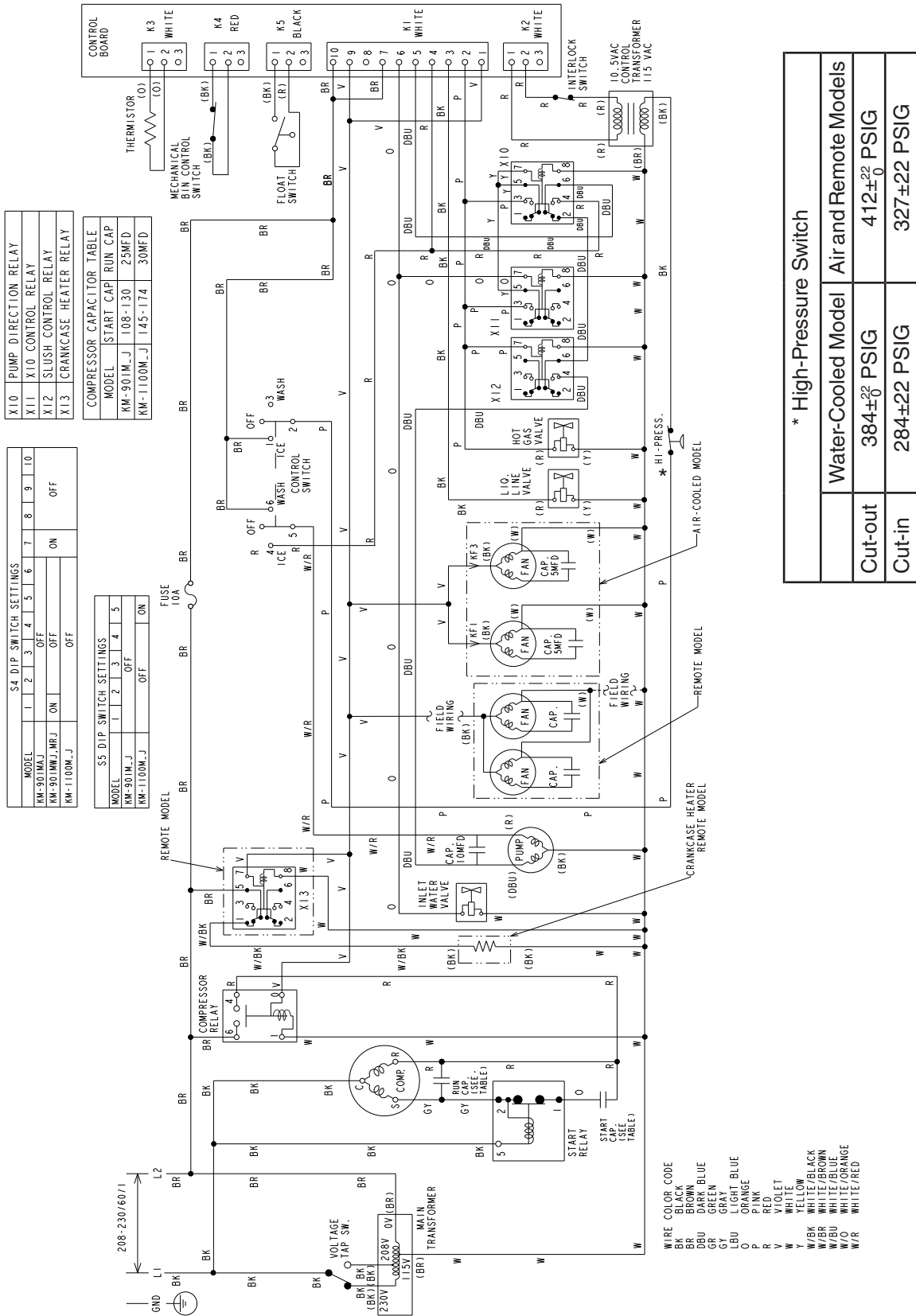

* High-Pressure Switch		
Water-Cooled Model	Air and Remote Models	
Cut-out	384±20 PSIG	412±22 PSIG
Cut-in	284±22 PSIG	327±22 PSIG

c) KM-901MRJ(Z)3 Thermostatic Bin Control

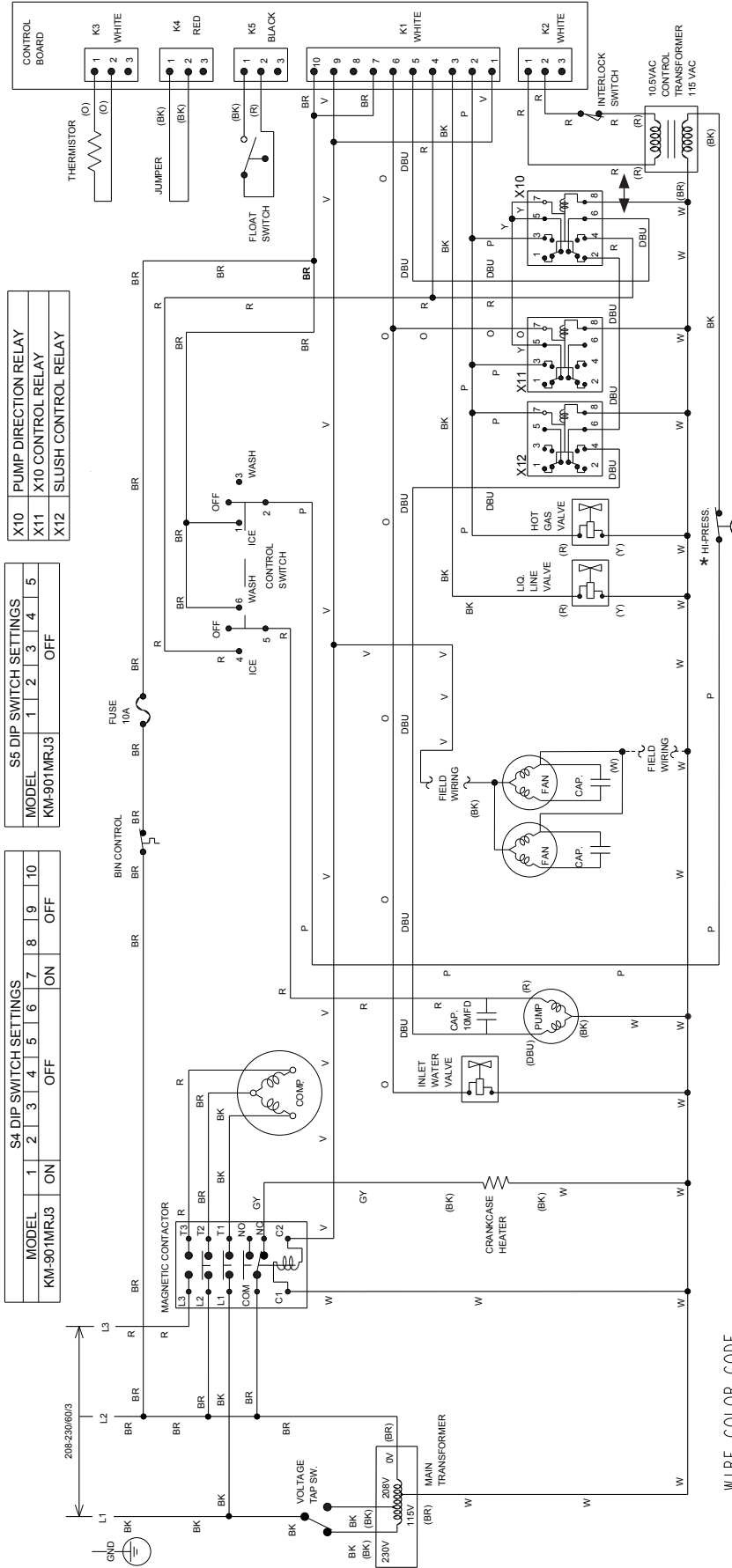

S4 DIP SWITCH SETTINGS	
MODEL	KM-901MRJ3
1	ON
2	ON
3	OFF
4	OFF
5	OFF
6	OFF
7	ON
8	ON
9	OFF
10	OFF

S5 DIP SWITCH SETTINGS	
MODEL	KM-901MRJ3
1	OFF
2	OFF
3	OFF
4	OFF
5	OFF

X10 CONTROL RELAY	
MODEL	KM-901MRJ3
1	OFF
2	OFF
3	OFF
4	OFF
5	OFF

X11 CONTROL RELAY	
MODEL	KM-901MRJ3
1	OFF
2	OFF
3	OFF
4	OFF
5	OFF

X12 CONTROL RELAY	
MODEL	KM-901MRJ3
1	OFF
2	OFF
3	OFF
4	OFF
5	OFF

* High-Pressure Switch	
Cut-out	412±22 PSIG
Cut-in	327±22 PSIG

- WIRE COLOR CODE
- BK BLACK
 - BR BROWN
 - DBU DARK BLUE
 - GR GREEN
 - GY GRAY
 - LBU LIGHT BLUE
 - O ORANGE
 - P PINK
 - R RED
 - V VIOLET
 - W WHITE
 - Y YELLOW
 - W/BK WHITE/BLACK
 - W/BR WHITE/BROWN
 - W/BU WHITE/BLUE
 - W/O WHITE/ORANGE
 - W/R WHITE/RED

d) KM-901MRJ(Z)3 Mechanical Bin Control

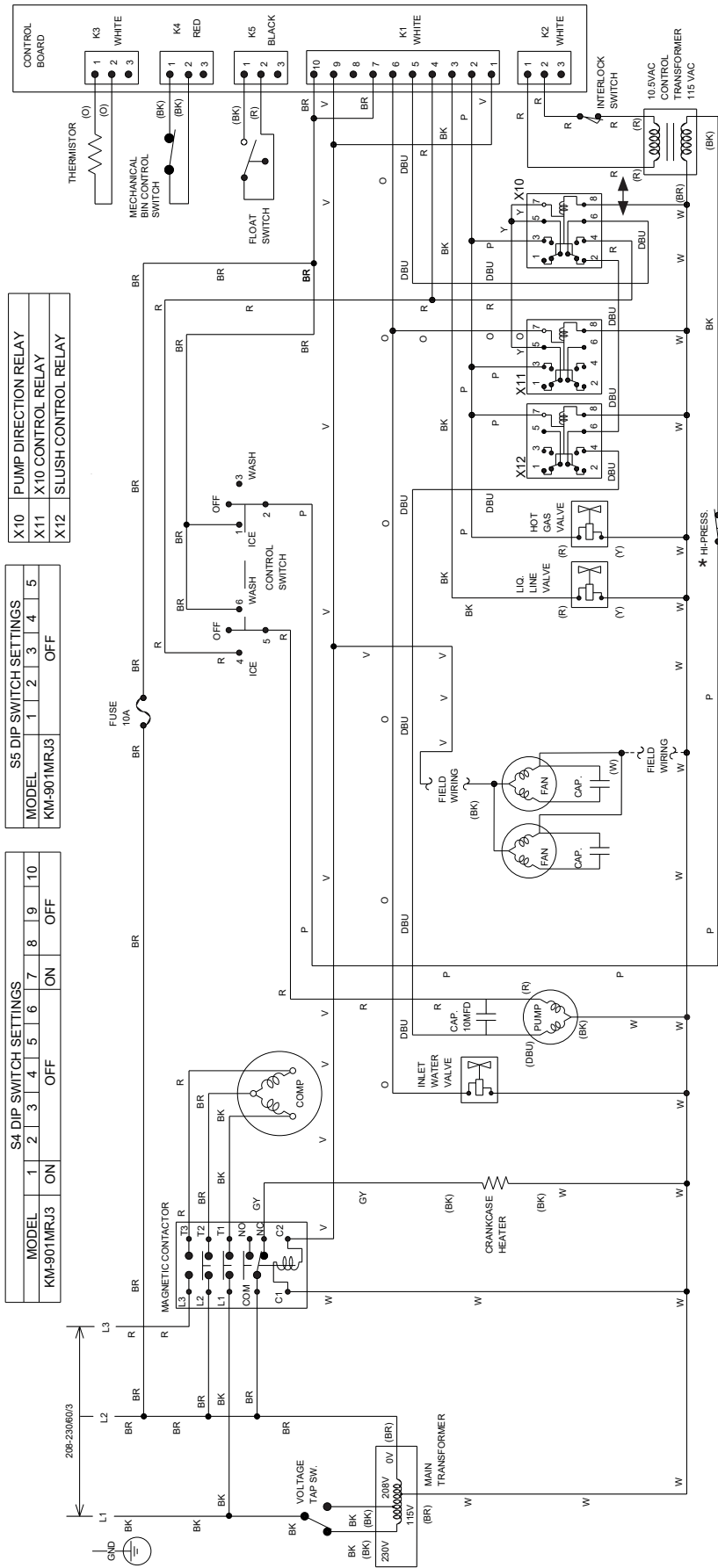

X10	PUMP DIRECTION RELAY
X11	X10 CONTROL RELAY
X12	SLUSH CONTROL RELAY

S5 DIP SWITCH SETTINGS					
MODEL	1	2	3	4	5
KM-901MRJ3					OFF

S4 DIP SWITCH SETTINGS										
MODEL	1	2	3	4	5	6	7	8	9	10
KM-901MRJ3	ON					OFF		ON		OFF

* High-Pressure Switch	
Cut-out	412±22 PSIG
Cut-in	327±22 PSIG

- WIRE COLOR CODE
- BK BLACK
 - BR BROWN
 - DBU DARK BLUE
 - GR GREEN
 - GY GRAY
 - LBU LIGHT BLUE
 - O ORANGE
 - P PINK
 - R RED
 - V VIOLET
 - W WHITE
 - Y YELLOW
 - W/BK WHITE/BLACK
 - W/BR WHITE/BROWN
 - W/BU WHITE/BLUE
 - W/O WHITE/ORANGE
 - W/R WHITE/RED

2. Auxiliary Code: N-3 and Earlier

a) KM-1340M_J(Z) and KM-1601MRJ(Z) Thermostatic Bin Control

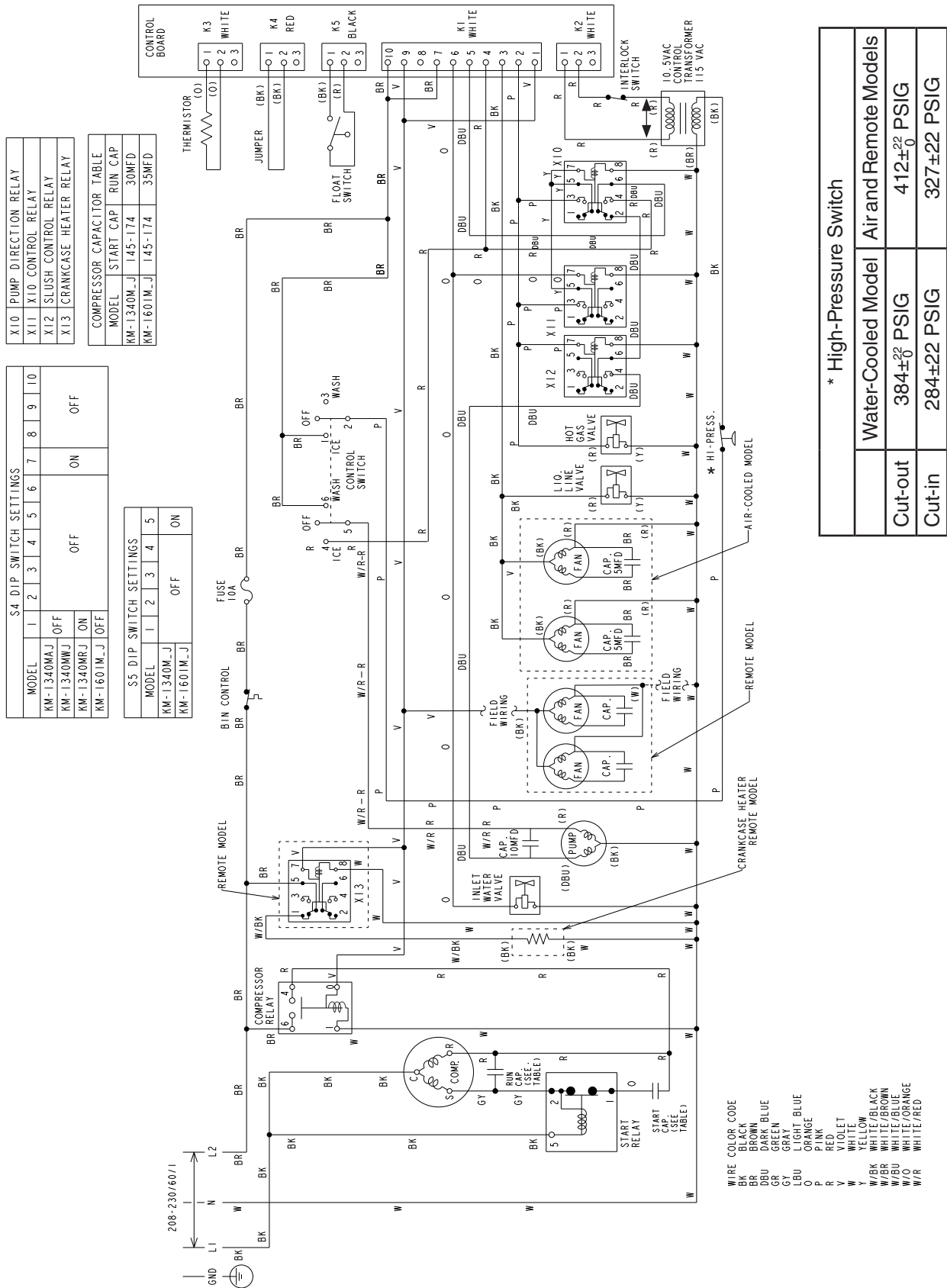

* High-Pressure Switch		
Water-Cooled Model	Air and Remote Models	
Cut-out	384±22 PSIG	412±22 PSIG
Cut-in	284±22 PSIG	327±22 PSIG

b) KM-1340M_J(Z) and KM-1601MRJ(Z) Mechanical Bin Control

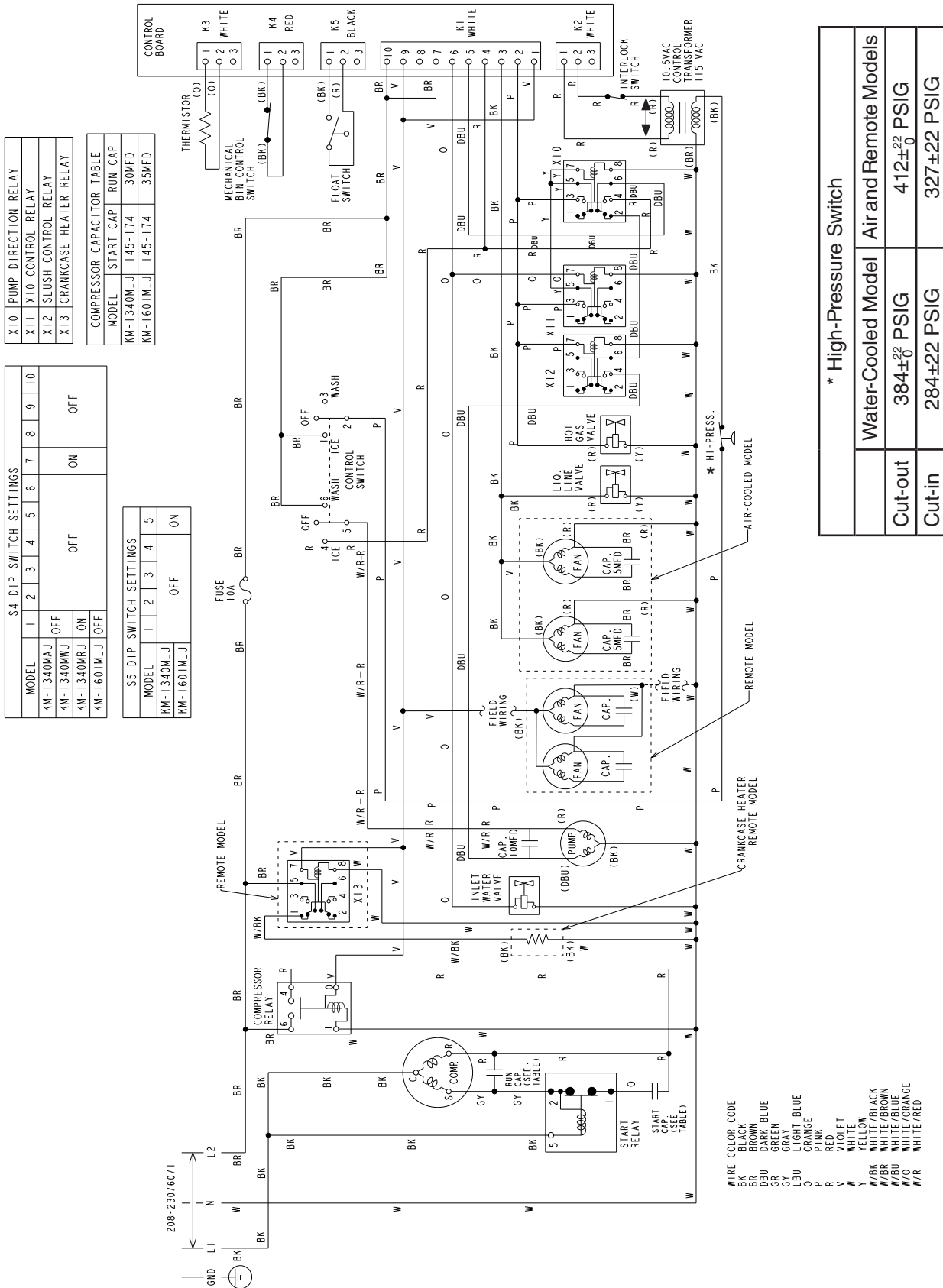

* High-Pressure Switch	
Water-Cooled Model	Air and Remote Models
Cut-out	384± ²² / ₀ PSIG
Cut-in	284±22 PSIG

c) KM-1340MRJ(Z)3 and KM-1601MRJ(Z)3 Thermostatic Bin Control

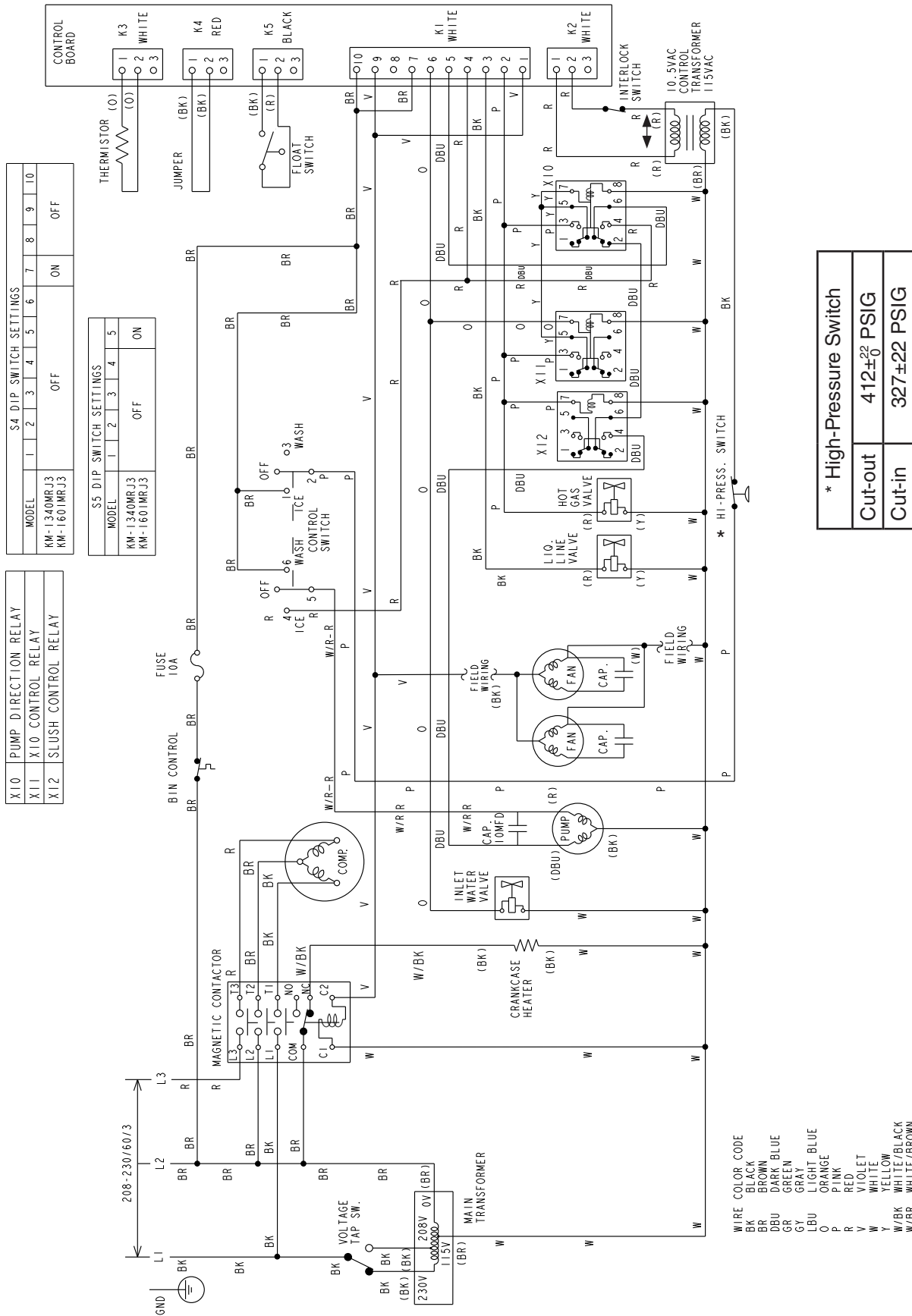

d) KM-1340MRJ(Z)3 and KM-1601MRJ(Z)3 Mechanical Bin Control

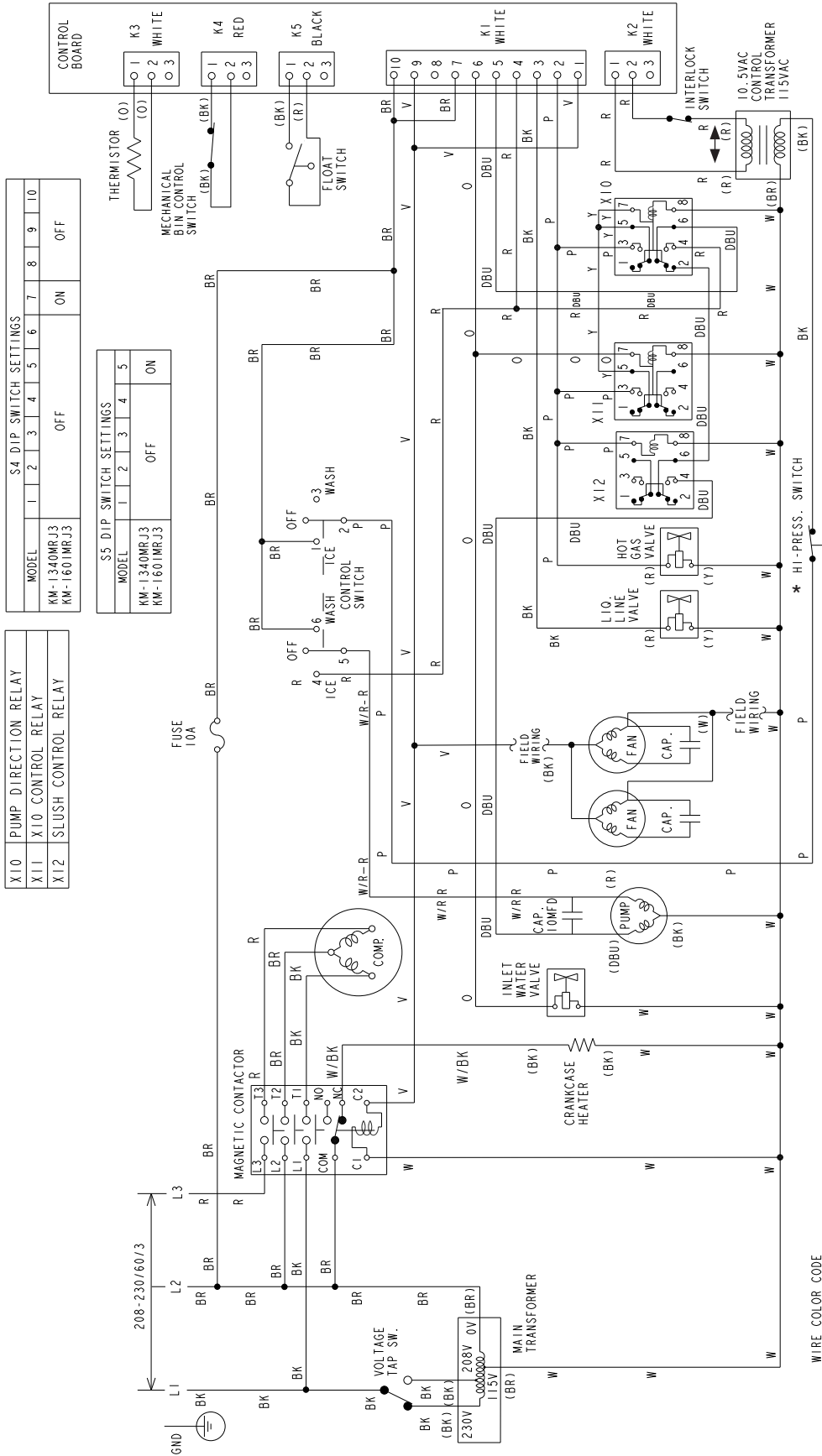

* High-Pressure Switch	
Cut-out	412±22 PSIG
Cut-in	327±22 PSIG

3. Auxiliary Code: P-3 and Later

a) KM-901M_J(Z)

Ultrasonic Bin Control

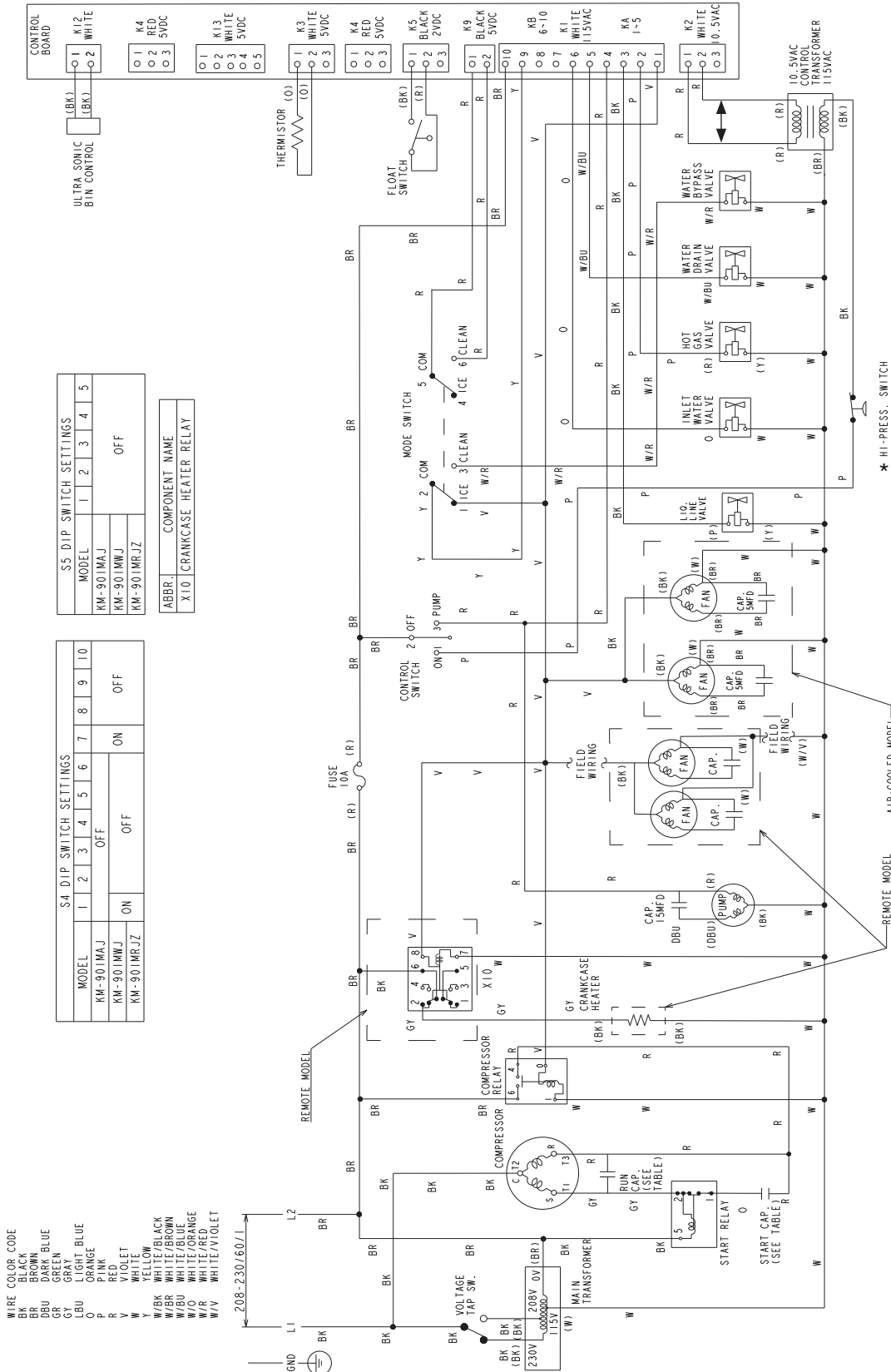

* High-Pressure Switch

Water-Cooled Model	Air and Remote Models
Cut-out	384±2 ⁰ PSIG
Cut-in	284±22 PSIG
	412±22 PSIG
	327±22 PSIG

b) KM-1100M_J(Z)
Ultrasonic Bin Control

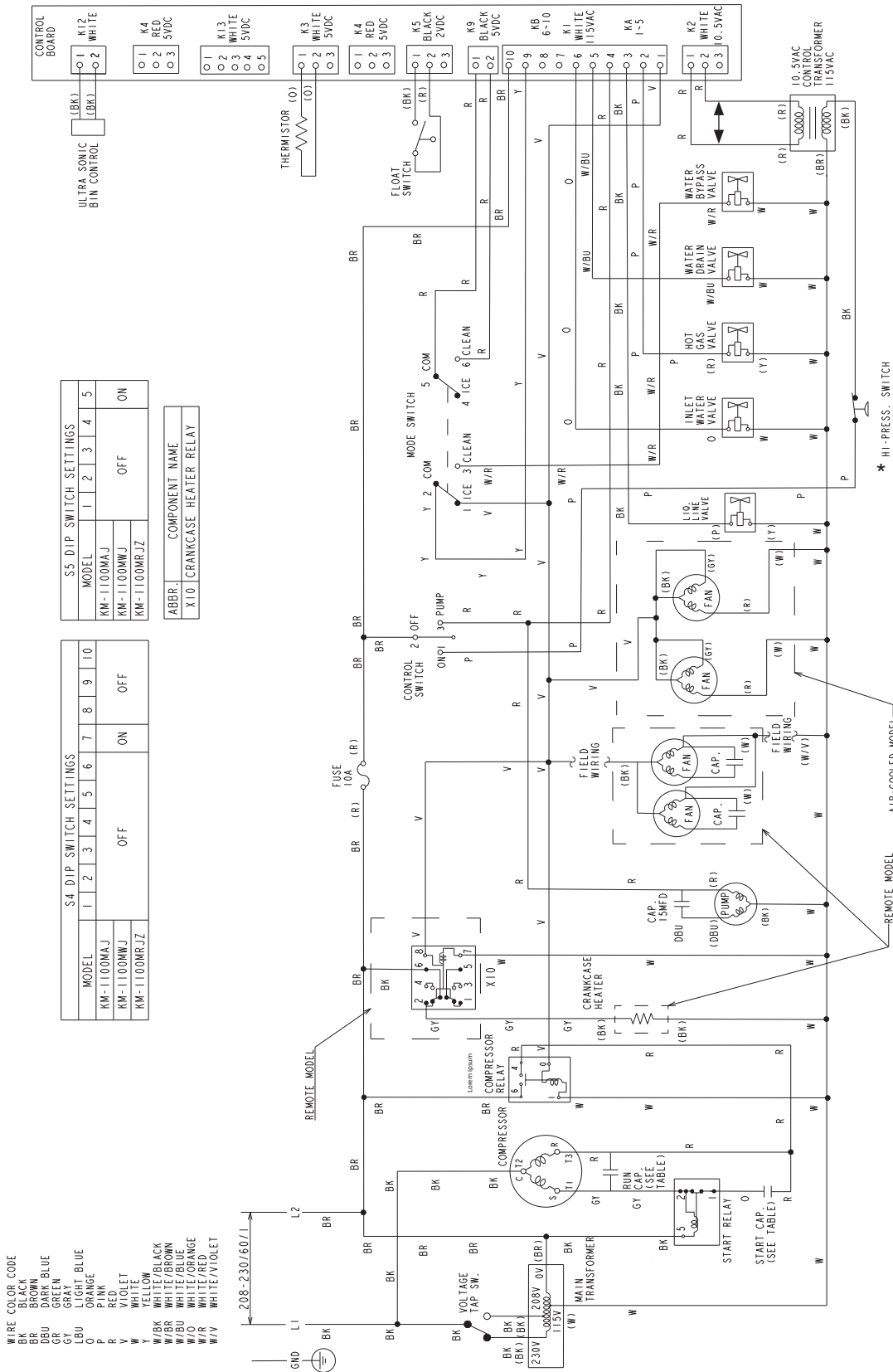

* High-Pressure Switch		
Water-Cooled Model	Air and Remote Models	
Cut-out	384±2 ⁰ PSIG	412±2 ⁰ PSIG
Cut-in	284±22 PSIG	327±22 PSIG

4. Auxiliary Code: P-0 and Later

a) KM-1340M_J(Z) and KM-1601MRJZ Ultrasonic Bin Control

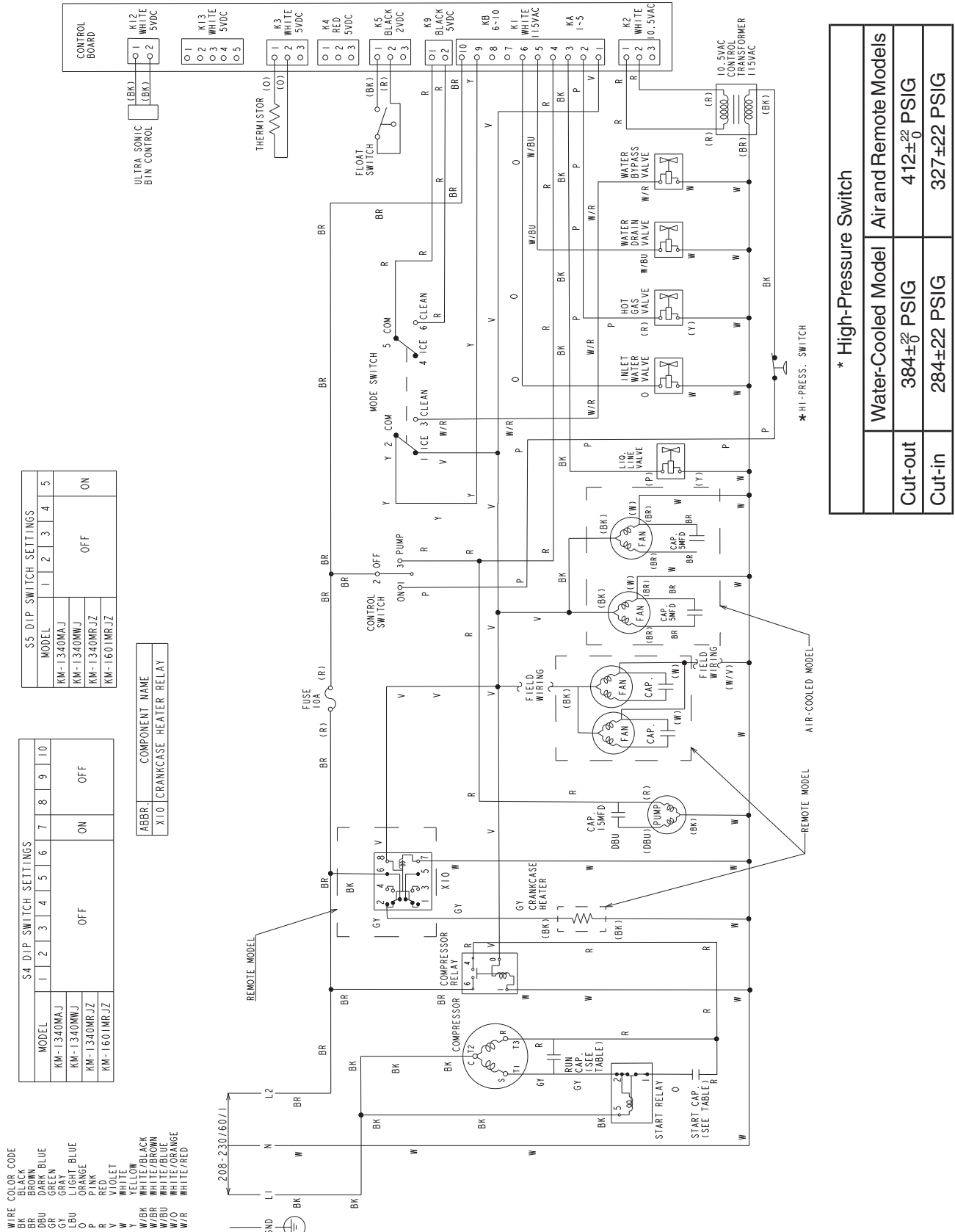

* High-Pressure Switch	
Water-Cooled Model	Air and Remote Models
Cut-out	384±20 PSIG
Cut-in	284±22 PSIG
	412±20 PSIG
	327±22 PSIG

b) KM-1340MRJZ3 and KM-1601MRJZ3 Ultrasonic Bin Control

