

# 90 ALBERTINE INDUCTION: C9-I

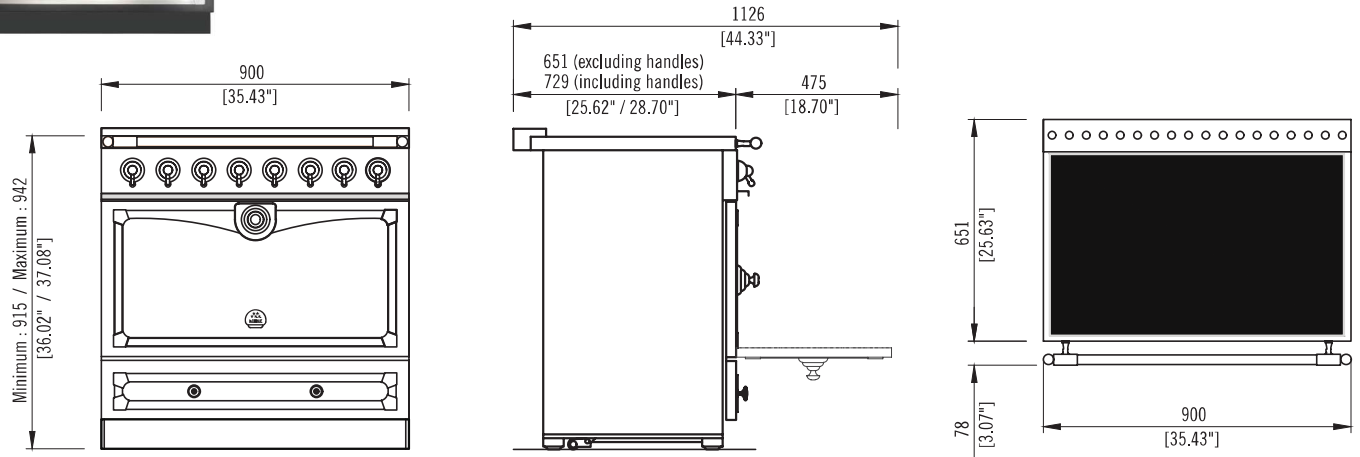

Designed especially for the US market, the single oven “Albertine” range is the baby of the CornuFé family. With one large multi-function convection oven, a five zone induction cooktop constructed of durable ceramic glass that easily wipes clean, and one large storage drawer. The CornuFé 90 is available in eleven colors and 3 trim accent choices of Polished Brass, Satin Chrome and Polished Chrome.



## SPECIFICATIONS

### CORNUFÉ 90 “ALBERTINE” INDUCTION: c9-i

900 W x 651 (w/o Handles), 729 (w/ Handles) D x 915 (942 max) H (mm)  
 35.4 W x 25.62 (w/o Handles), 28.70 (w/ Handles) D x 36.02 (37.08 max) H (inches)  
 315 lb uncrated, 410 lb Crated  
 High-performance 5 zone induction cooktop  
 Large electric convection oven

#### Induction Cooktop ratings:

Front Left: 1.4 kW (Max) 2.2 kW (Boost)  
 Rear Left: 1.85 kW (Max) 3.0 kW (Boost)  
 Center: 2.3 kW (Max) 3.7 kW (Boost)  
 Front Right: 1.85 kW (Max) 3.0 kW (Boost)  
 Rear Right: 1.85 kW (Max) 3.0 kW (Boost)  
*Note: Front Right and Rear Right Burners can be bridged*

#### POWER

Voltage: 240v; 60Hz, 50 AMP

#### FINISHES

**Five Classic Colors:** Matte Black, Stainless Steel, Gloss Black, Provence Blue, and Pure White

**Four Étoile Colors:** Morning Dew, Graphite, Ocean, and Wintersky

**Suzanne Kasler Color Collection Colors:** Tapestry and Roquefort

**Three Trim Options:** 1) Stainless Steel Trim and Rail with Satin Chrome Accents, 2) Stainless Steel Trim with Polished Brass Rail and Accents, and 3) Stainless Steel Trim, Polished Stainless Steel Rail, with Polished Chrome Accents

NOTE: Side panels are stainless steel for all colors except Gloss Black and Matte Black ranges have flat black side panels. The Polished Brass Trim is natural, non coated metal and will patina over time.

#### Ovens:

Enameled steel door with glass inner door  
 Electric convection oven featuring 7 cooking modes  
 2 Convection Fans, 8 Heating Elements  
 1 Deluxe oven tray  
 1 Large Tray Equipped with Broil Pan  
 1 Pastry Tray  
 2 Telescopic Racks  
 714 W x 389 D x 381 H (mm)  
 28.1 W x 15.3 D x 15 H (inches)  
 3.81 cubic feet

# 90 ALBERTINE INDUCTION: C9-I

## CORNUFÉ HOOD COLLECTION

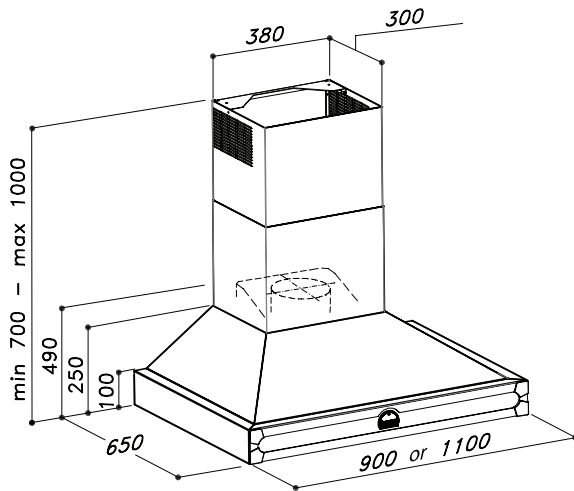

### CORNUFÉ 90 HOOD: H9

900 W x 650 D x 700 H (mm)  
 35.4 W x 25.6 D x 27.5 H (inches)  
 Traditional wall-mounted chimney hood  
 Available in all color and trim options  
 4-Speed Variable Motor  
 One 600 CFM blower – unobstructed air flow with Ø6" duct  
 Remote Control and In-Hood Activation Controls  
 Three 20W high-intensity lights  
 2 dishwasher-safe baffle filters with grease capture system  
 Voltage: 120v; 60Hz, total rating: 425W, 3.6 AMP  
 Telescopic flue cover extends to maximum hood height of 39.3" (1000 mm)

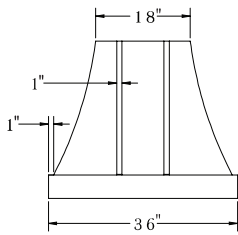

FRONT VIEW

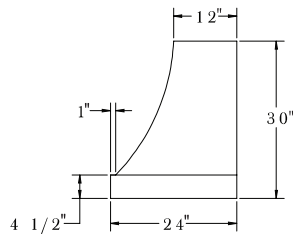

SIDE VIEW

### CORNUFÉ CASCADE : CH3630CAC & CH4430CAC

Hood Style: Concave  
 Available in both 36" & 44"  
 36"W x 24"D x 30"H (600 cfm/8" collar)  
 44"W x 24"D x 30"H (1200 cfm/10" collar)

Duct Cover Options:  
 12", 24" and 48" Tall  
*Custom Duct Cover heights are available*

Product Weight:  
 36"(30"H) : 97 lbs  
 44"(30"H) : 124 lbs

Electrical Requirements:  
 600 CFM models draw approx. 2.7 Amps  
 1200 CFM models draw approx. 5.4 Amps

Hood Sone Level:  
 Ranges from 5-7

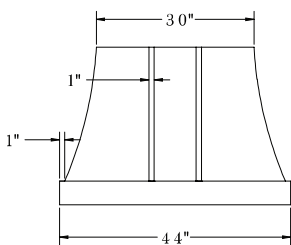

FRONT VIEW

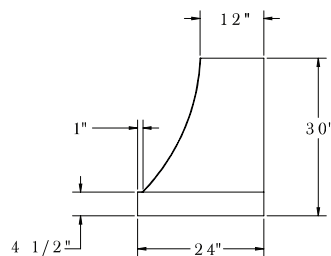

SIDE VIEW

# 90 ALBERTINE INDUCTION: C9-I

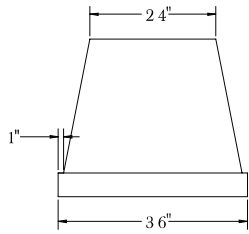

FRONT VIEW

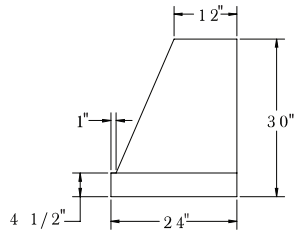

SIDE VIEW

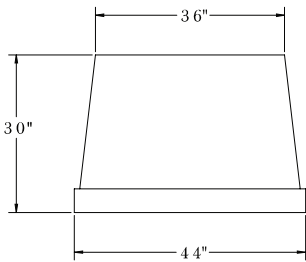

FRONT VIEW

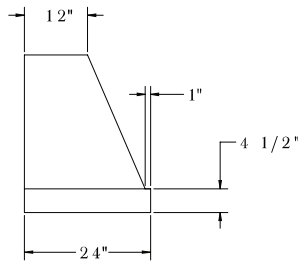

SIDE VIEW

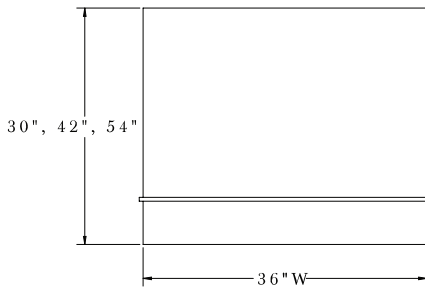

FRONT VIEW

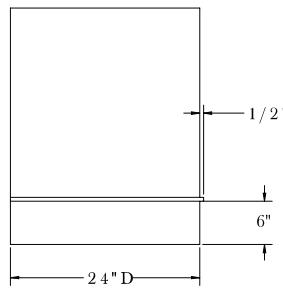

SIDE VIEW

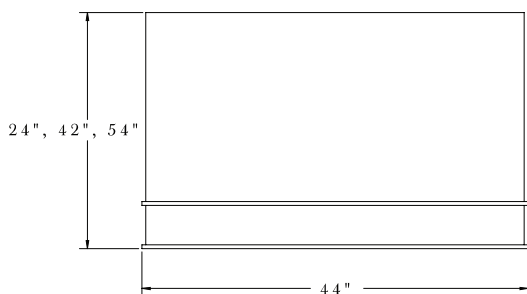

FRONT VIEW

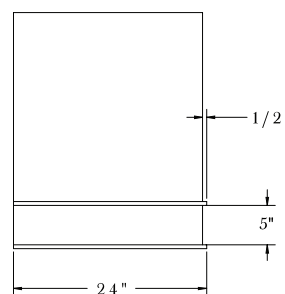

SIDE VIEW

## CORNUFÉ EUCLID : CH3630EUC & CH4430EUC

Hood Style: Trapezoid

Available in both 36" & 44"  
 36"W x 24"D x 30"H (600 cfm/8" collar)  
 44"W x 24"D x 30"H (1200 cfm/10" collar)

Duct Cover Options:  
 12", 24" and 48" Tall  
*Custom Duct Cover heights are available*

Product Weight: 36"(30"H) : 98 lbs/ 44"(30"H) : 126 lbs

Electrical Requirements:  
 600 CFM models draw approx. 2.7 Amps  
 1200 CFM models draw approx. 5.4 Amps

Hood Sone Level:  
 Ranges from 5-7

## CORNUFÉ LOGE : CH3630LGE & CH4430LGE

Hood Style: Box

Available in both 36" & 44"  
 36"W x 24"D x 30"H, 42"H or 54"H (600 cfm/8" collar)  
 44"W x 24"D x 30"H, 42"H or 54"H (1200 cfm/10" collar)

Product Weight:  
 36"(30"H) : 104 lbs / 36"(42"H) : 122 lbs / 36"(54"H) : 141 lbs  
 44"(30"H) : 130 lbs / 44"(42"H) : 151 lbs / 44"(54"H) : 172 lbs

Electrical Requirements:  
 600 CFM models draw approx. 2.7 Amps  
 1200 CFM models draw approx. 5.4 Amps

Hood Sone Level:  
 Ranges from 5-7

# 90 ALBERTINE INDUCTION: C9-I

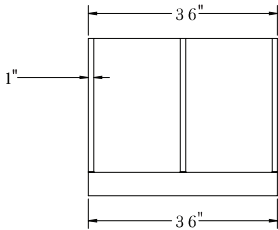

FRONT VIEW

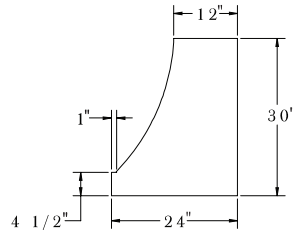

SIDE VIEW

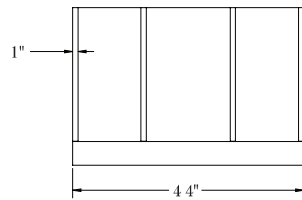

FRONT VIEW

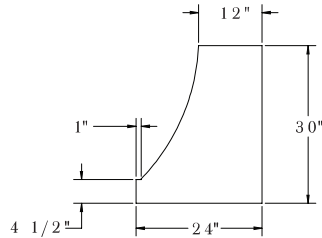

SIDE VIEW

**CORNUFÉ MARQUEE** : CH3630MRQ & CH4430MRQ

Hood Style: Arched Front

Available in both 36" & 44"  
 36"W x 24"D x 30"H (600 cfm/8" collar)  
 44"W x 24"D x 30"H (1200 cfm/10" collar)

Duct Cover Options:  
 12", 24" and 48" Tall  
*Custom Duct Cover heights are available*

Product Weight: 36"(30"H) : 101 lbs/ 44"(30"H) : 126 lbs

Electrical Requirements:  
 600 CFM models draw approx. 2.7 Amps  
 1200 CFM models draw approx. 5.4 Amps

Hood Sone Level:  
 Ranges from 5-7

CORNUFÉ SERIES DETAILS & ACCESSORIES

CLASSIC COLORS

<b>N</b>	Matte Black
<b>M</b>	Gloss Black
<b>I</b>	Stainless Steel
<b>W</b>	Pure White
<b>L</b>	Provence Blue

ÉTOILE COLORS

<b>P</b>	Morning Dew
<b>G</b>	Graphite
<b>O</b>	Ocean
<b>H</b>	Wintersky

SUZANNE KASLER COLORS

<b>A</b>	Tapestry
<b>Q</b>	Roquefort

TRIM OPTIONS

	Trim	Accents	Rails
<b>N</b>	Stainless Steel	Satin Chrome	Stainless Steel
<b>F</b>	Stainless Steel	Polished Brass	Polished Brass
<b>P</b>	Stainless Steel	Polished Chrome	Polished Stainless Steel

**Note:** The Polished Brass Trim is natural, non coated metal and will patina over time.

ACCESSORIES:

Part Number	Description
09KIRSIR01	Recirculating kit for CornuFe Hood

Please confirm inventory status at time of order.