

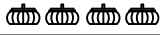





# Assembly Instruction

ITEM#: 1468-5 DRESSER  
1468-6 MIRROR

## PART LIST

1	DRESSER	1 PC
2	BUN FOOT 	4 PCS
3	MIRROR	1 PC
4	MIRROR SUPPORT	2 PCS

## ANTI-TIPPING HARDWARE PACK IN-5

A		BRACKET	2 PCS
B		TIE WRAP	1 PC
C		LONG SCREW #8x2"L	1 PC
D		SHORT SCREW #8x5/8"L	1 PC

## HARDWARE LIST IN-M

E		LONG BOLT $\varnothing 5/16$ "x2"	4 PCS
F		SHORT BOLT $\varnothing 5/16$ "x1-1/2"	4 PCS
G		FLAT WASHER 5/16"	8 PCS
H		SPRING WASHER 5/16"	8 PCS
I		ALLEN KEY 5/16"	1 PC

### STEP 1

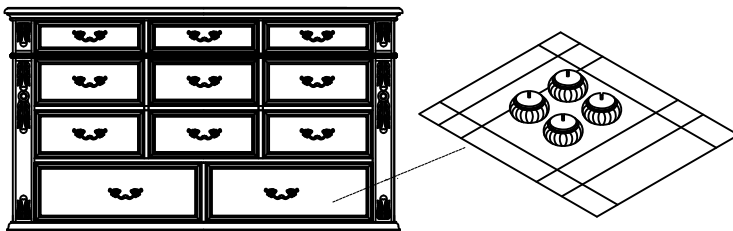

### STEP 2

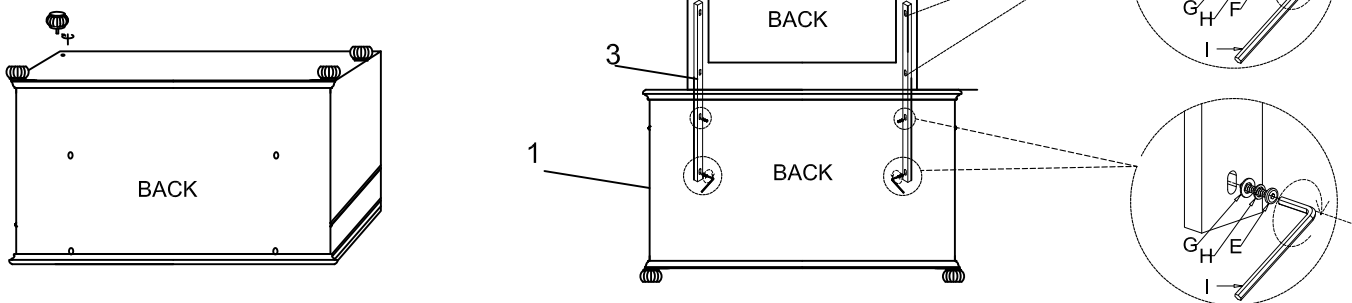

### STEP 3

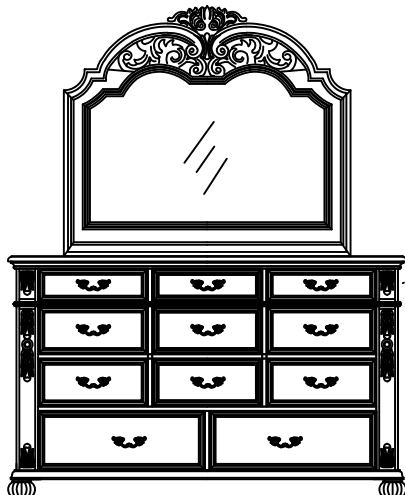

-REMOVE ANTI-TIPPING PACK FROM BACK PANEL. ASSEMBLE IT TO AVOID TIPPING.

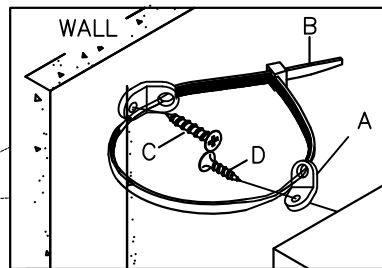

Assembly completed



- For items use on wooden floor hard surfaces or carpets. It is recommended to install protective pads under all legs and supports to avoid/prevent from damages/scratches and discoloration.
- Hardware may loosen over time. Periodically check to make sure all connections are tight. Re-tight if necessary.