

DWHD661EFP

STAR SAPPHIRE® 7-PROGRAM DISHWASHER

PROFESSIONAL COLLECTION HANDLE

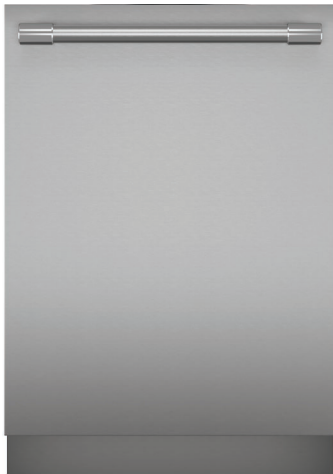

Home Connect

Also Available:

DWHD661EFM – Flat Stainless Steel Panel with Masterpiece® Collection Handle

DWHD661EPR – Custom Panel

FEATURES & BENEFITS

- ★ - StarDry™ — No one dries better. Star Dry with Zeolite: the ultra-powerful program that dries dishes better so place settings, glassware, and even sturdy plastics and containers with hard-to-reach crevices are ready for use immediately after each cycle
- ★ - Multi-Color Star Glow light illuminates your dishwasher with any color you choose via the Home Connect® app.
 - Adjustable Chef's Tool Drawer® delivers added loading capacity as well as flexibility to accommodate larger or smaller items, wider ends and utensil handles
 - The ZoneControl™ Spray Arm amplifies the exceptional PowerWash™ performance by letting you customize the cleaning power to deep clean even the most challenging dishes, in the lower rack.
 - Time Remaining PowerBeam® shines the actual remaining time of the cycle on the floor
 - Smooth-glide ball bearing wheels on lower, upper, and third rack
 - 18 Wine Glass Capacity — No need to clean your glassware in two cycles; wash them all at once so you can get back to your guests
 - Use the exclusive Home Connect® app to refine your cleanup routine with remote control and receive timely notifications that keep track of every dish tab so you never run out

GENERAL PROPERTIES

Number of Wash Cycles	6+3 Additional in Home Connect®
Number of Options	6+1 Additional in Home Connect®
Additional Wash Cycles and Options available in Home Connect®	Cycles: Machine Care, Rinse, Glass Options: Save Time
NSF®-Certified* Sanitize Option	Yes
dBA	42 dBA
Third Rack	Adjustable Chef's Tool Drawer®
Rack Adjustability	Rackmatic 3-Stage
Tub Material	Stainless Steel
Control Type	Touch Control
Concealed Water Heating Element	Yes
Leak Protection System	24/7 AquaStop®
Water Softener	Yes
Five-Level Wash	Yes
Childlock	No
Home Connect® (Wi-Fi Enabled)	Yes

EFFICIENCY

Water Usage Per Cycle	3.2 g
Energy Efficiency Class	Tier 1
ENERGY STAR® Certified	Yes
Total Annual Energy Consumption	240 kWh
Total Annual Water Consumption	623.5 g

CAPACITY

Number of Place Settings	16
--------------------------	----

TECHNICAL DETAILS

Watts	1440 W
Current	12 A
Volts	120 V
Frequency	60 Hz
Power Cord Length	67"
Power Cord Install Length from Corner of Unit when Facing the Door	Left - 45" Right - 56"
Minimum Water Pressure	14 (lb/sin)
Max. Temperature for Water Intake	140° F
Length Inlet Hose	N/A
Length Outlet Hose	90.5"

DIMENSIONS & WEIGHT

Overall Appliance Dimensions (HxWxD)	33 7/8" x 23 9/16" x 23 3/4"
Required Cutout Size (HxWxD)	33 7/8" Min. x 23 5/8" Min. x 24"
Adjustable Feet	Yes
Net Weight	101 lbs.

*Certification to NSF/ANSI Standard 184 for residential dishwashers

DWHD661EFP

STAR SAPPHIRE® 7-PROGRAM DISHWASHER

PROFESSIONAL COLLECTION HANDLE



WARRANTY	
Limited Warranty, Entire Appliance, Parts and Labor	2 Year
Limited Warranty for Microprocessor or Printed Circuit Board; Parts Only	3rd to 5th Year
Limited Warranty for Racks (Does Not Include Rack Components); Parts Only	3rd to 5th Year
Limited Warranty for Rust-through On Inner Tub Liner; Parts Only	Lifetime

ACCESSORIES (OPTIONAL)	
Dishwasher Installation Kit (Junction Box, 90° Elbow and Water Supply Hose)	SMZ3IN1UC
Dishwasher Supply and Drainage Hose Extension 76 3/4"	SGZ1010UC
Junction Box	SMZPCJB1UC
Cabinet Protector with Power Cord Clip	SMZEPCC1UC
Water Supply Hose	SMZSH1ABUC
Dishwasher Accessory Kit**	SMZ5000
Duo Silverware Basket	SMZ4000UC
Fine Silverware Carafe	SMZ5002UC



**Accessory Kit includes Extra-Tall-Item Sprinkler, Vase / Bottle Holder, 3 Plastic Item Clips and Small Item Basket



Duo Silverware Basket



Fine Silverware Carafe

DISHWASHER & CUTOUT DIMENSIONS

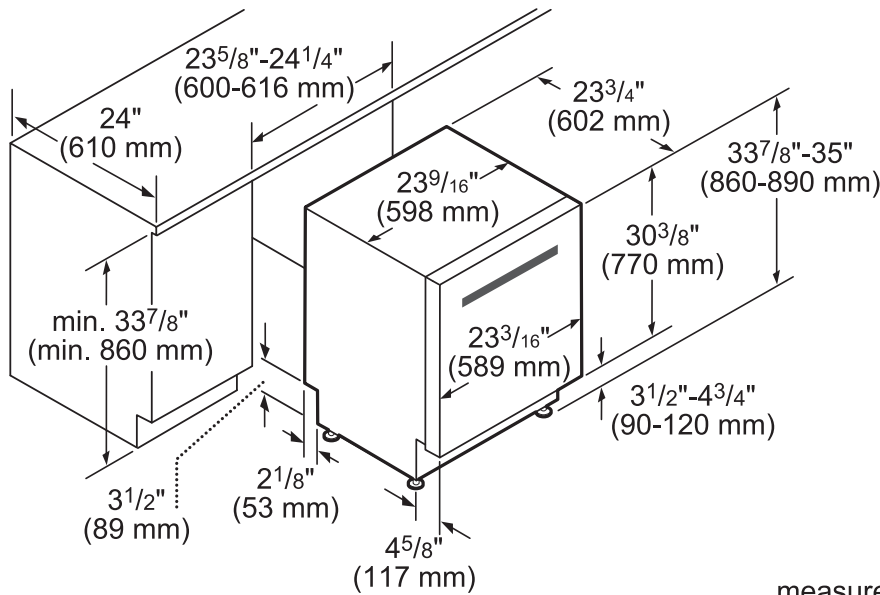

measurements in inches and mm

These warranties give you specific legal rights and you may have other rights that vary from state to state. Limited warranty from date of delivery. For complete warranty details, refer to your Use & Care manual, or ask your dealer.

Specifications are for planning purposes only. Refer to installation instructions and consult your countertop supplier prior to making counter opening. Consult with a heating and ventilation engineer for your specific ventilation requirements. For the most detailed information, refer to installation instructions accompanying product or write to Thermador indicating the model number. Specifications are correct at time of printing. Thermador reserves the right to change product specifications or design without notice. Some models are certified for use in Canada. Thermador is not responsible for products that are transported from the U.S. for use in Canada.