

# CLASSIC RANGE SERIES (CDR)

30 in. 4.2 cu. ft. Dual Fuel Range with 4 Burner Gas Cooktop and Electric Convection Oven

**ZLINE**  
ATTAINABLE LUXURY®

## CDR30 Stainless Steel

All 30" models come standard with 1 brass dual burner



Black Stainless Steel



Satin Stainless Steel



## FEATURES AND BENEFITS

**Italian-Made Auto Re-ignition Burners:** 4 Italian-made gas burners utilize automatic re-ignition innovation for improved temperature control and cooktop safety.

**Horizon Oven Window:** The Classic Series ranges feature a sleek Landscape oven door design that provides ample viewing space to ensure dishes inside are perfectly cooked.

**Powerful Convection Cooking:** Handle bakes with ease with a high-speed and high-wattage convection fan that maintains precise heat distribution.

**Dual Function Burner:** The Dual Function Burner allows you to simmer at 800 BTU or perfectly sear at 20,000 BTU.

**Dual Fuel Flexibility:** Savor the benefits of dual fuel cooking with a high-powered gas cooktop and an electric oven with high-grade heating elements that ensure consistent temperature ranges.

**Large Oven Capacity:** Large oven capacity of 4.2 cu. ft. fits pans up to 20 in. wide for maximum space and convenience.

**StayPut Oven Door Hinges:** Designed to support the full weight of the oven door, offering additional convenience and safety.

**Premium Oven Insulation:** A 3-layered glass oven door with a large viewing window and aluminum mesh seal offers superior heat retention and consistent temperatures.

**Smooth Glide Ball-Bearing Oven Racks:** 2 durable ball bearing oven racks provide extra convenience and ease when working with larger dishes.

**LP Conversion Kit:** Comes equipped with an LP conversion kit to convert from natural gas to liquid propane (must be done by a professional), offering versatility with your cooking preference.

## OVEN FEATURES

|                     |                               |
|---------------------|-------------------------------|
| Interior Dimensions | 24 7/8" W x 17 3/4" D x 16" H |
| Self-Clean          | No                            |
| Oven Lighting       | (2) Halogen                   |
| Oven Features       | Bake, Broil, Convection Bake  |
| Convection Fan      | Yes                           |
| Number of Racks     | 2                             |
| Child Lock          | No                            |

## OVEN WATTAGE

|              |        |
|--------------|--------|
| Broil Output | 4200 W |
| Bake Output  | 3000 W |

## ELECTRICAL REQUIREMENTS

240 V / 60 Hz / 25 A Dedicated Circuit

## LIMITED WARRANTY

**Manufacturing Warranty:** 1-year parts and labor.

**Italian Burners and Spark Tips:** Limited Lifetime Warranty.

*Limited Lifetime includes: parts replacements for burners, burner caps, and parts and labor for the spark tip if parts prove to be defective in materials or workmanship.*

*\*Appliance protection plans sold separately, contact for more information.*

## GENERAL PROPERTIES

|               |   |
|---------------|---|
| SKUs          | CDR30, CDRS-30, CDRB-30                                       |
| Base Finishes | Stainless Steel, Black Stainless Steel, Satin Stainless Steel |
| Fuel Type     | Convection Electric Oven-Gas Cooktop                          |
| Burners       | 4   |
| Mount Type    | Free Standing   |
| Timer         | No  |
| Material      | 430 Grade Stainless Steel                                     |
| Grates        | Professional  |
| Certification | ETL Certified   |

## DIMENSIONS AND WEIGHT

|                    |                               |
|--------------------|-------------------------------|
| Product Dimensions | 30" W x 27 3/4" D x 36" H     |
| Cutout Dimensions  | 30 1/4" W x 24 3/4" D x 36" H |
| Product Weight     | 229 lb (103.87 kg)            |

## COOKTOP FEATURES

|         |  |
|---------|--|
| Burners | (3) Aluminum Burners and (1) Brass Burner                |
| Cooktop | Porcelain With Electronic Spark Ignition For All Burners |

## COOKTOP BTU (Electronic Ignition and Auto Re-ignition)

|                         |            |
|-------------------------|------------|
| Back Left (Semi-Rapid)  | 9,000 BTU  |
| Front Left (Rapid)      | 15,000 BTU |
| Back Right (Semi-Rapid) | 9,000 BTU  |
| Front Right (Dual)      | 20,000 BTU |

**Not the right fit?** [Click here](#) to view our range collections.

# CLASSIC RANGE SERIES (CDR)

30 in. 4.2 cu. ft. Dual Fuel Range with 4 Burner Gas Cooktop and Electric Convection Oven

**ZLINE**  
ATTAINABLE LUXURY®

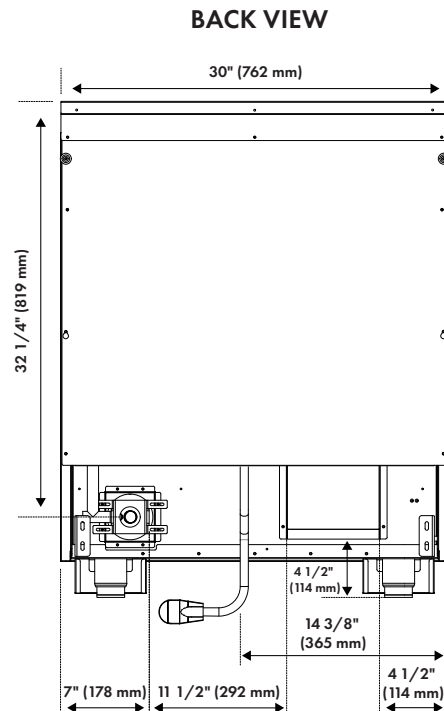
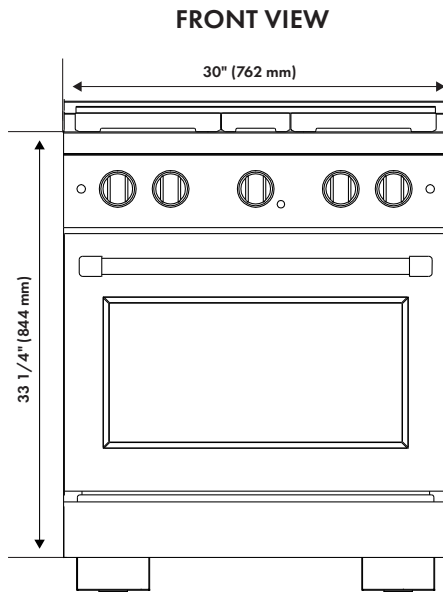

## INSTALLATION RESOURCES

Installation / User Manual

[Click Here](#)

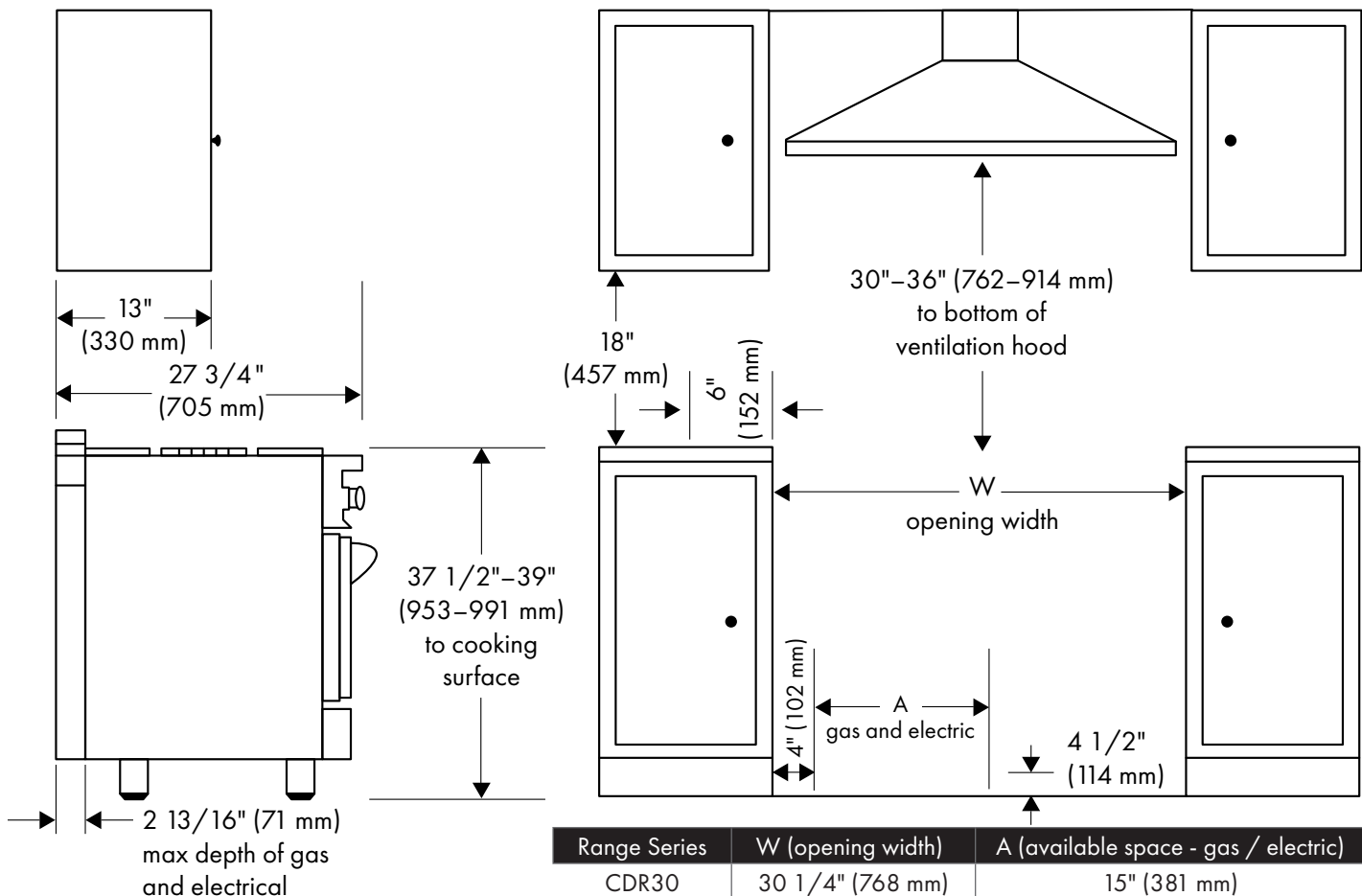

# AUTOGRAPH EDITION

*Andrew Ferro*

Satin Stainless Steel With  
Matte Black Accents



### SATIN STAINLESS STEEL

|                  |             |
|------------------|-------------|
| Polished Gold    | CDRSZ-30-G  |
| Champagne Bronze | CDRSZ-30-CB |
| Matte Black      | CDRSZ-30-MB |

Stainless Steel With  
Champagne Bronze Accents



### STAINLESS STEEL

|                  |            |
|------------------|------------|
| Polished Gold    | CDRZ-30-G  |
| Champagne Bronze | CDRZ-30-CB |
| Matte Black      | CDRZ-30-MB |

Black Stainless Steel With  
Polished Gold Accents



### BLACK STAINLESS STEEL

|                  |             |
|------------------|-------------|
| Polished Gold    | CDRBZ-30-G  |
| Champagne Bronze | CDRBZ-30-CB |

## AUTOGRAPH EDITION + COLORED DOOR

Stainless Steel White Matte Door  
With Polished Gold Accents



### STAINLESS STEEL WITH WHITE MATTE DOOR

|                  |               |
|------------------|---------------|
| Polished Gold    | CDRZ-WM-30-G  |
| Champagne Bronze | CDRZ-WM-30-CB |
| Matte Black      | CDRZ-WM-30-MB |

## AUTOGRAPH ACCENT COLORS

Autograph Edition Includes:  
Brass Burners, Autograph Edition Knobs, Knob Rings, Handle and 2 Feet Covers.

POLISHED GOLD

CHAMPAGNE BRONZE

MATTE BLACK

## BASE FINISHES

SATIN STAINLESS  
STEEL

BLACK STAINLESS  
STEEL

STAINLESS STEEL

# AUTOGRAPH EDITION

*Andrew Ferro*

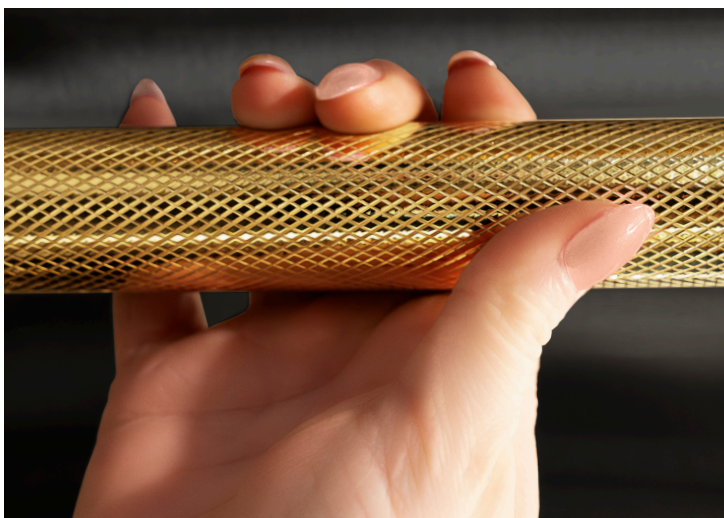

Helix Handles:

Not offered as a range bundle SKU. Handle must be purchased separately.



**POLISHED GOLD**



**CHAMPAGNE BRONZE**

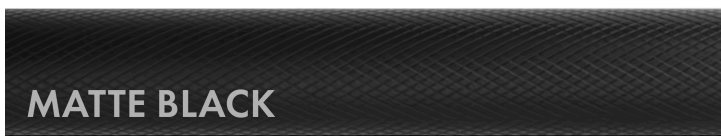

**MATTE BLACK**

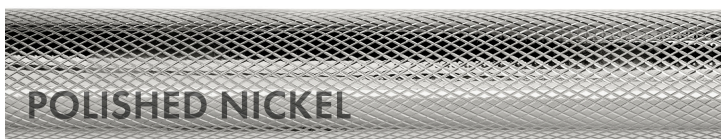

**POLISHED NICKEL**

## STANDARD HELIX HANDLE SET (SET OF 1)

|                                    |               |
|------------------------------------|---------------|
| Black Stainless Steel Helix Handle | SGZ-054B-K-BS |
| Stainless Steel Helix Handle       | SGZ-054B-K-ST |

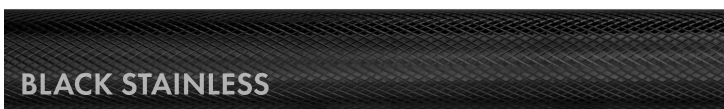

**BLACK STAINLESS**

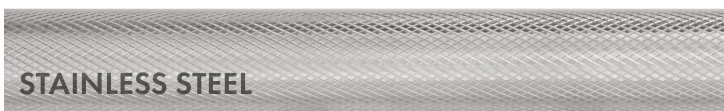

**STAINLESS STEEL**

## AUTOGRAPH HELIX HANDLE (SET OF 1)

|                               |               |
|-------------------------------|---------------|
| Polished Gold Helix Handle    | SGZ-054B-K-G  |
| Champagne Bronze Helix Handle | SGZ-054B-K-CB |
| Matte Black Helix Handle      | SGZ-054B-K-MB |
| Polished Nickel Helix Handle  | SGZ-054B-K-PN |

## RANGE + COLORED DOOR

Stainless Steel  
With White Matte Doors



### STAINLESS STEEL

|                  |            |
|------------------|------------|
| Black Matte Door | CDR-BLM-30 |
| White Matte Door | CDR-WM-30  |

Satin Stainless Steel  
With Black Matte Door



### SATIN STAINLESS STEEL

|                  |             |
|------------------|-------------|
| Black Matte Door | CDRS-BLM-30 |
| White Matte Door | CDRS-WM-30  |

## BRASS BURNER BUNDLE

Stainless Steel  
With Brass Burners



### STAINLESS STEEL

|                       |            |
|-----------------------|------------|
| Stainless Steel       | CDR-BR-30  |
| Black Stainless Steel | CDRB-BR-30 |

Set of 4 Italian  
Brass Burners



### SATIN STAINLESS STEEL

|                       |            |
|-----------------------|------------|
| Satin Stainless Steel | CDRS-BR-30 |
|-----------------------|------------|

\* Assembly Required: Colored doors will ship separately

\* Assembly Required: Brass burners will ship separately

# ZLINE KITCHEN ACCESSORIES

Range + Kitchen Compatible Accessories

**ZLINE**  
ATTAINABLE LUXURY®

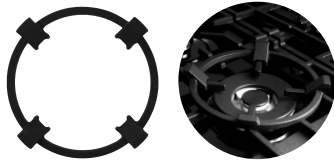

Cooktop Wok Ring | RA-005A



Cleaner/Polish | STCLT-8



Reversible Cast Iron Griddle | SR-GRNS



German Steel  
15 Piece Knife Set | KSETT-GS-15



German Steel  
3 Piece Knife Set | KSETT-GS-3



Japanese Damascus  
3 Piece Knife Set | KSETT-JD-3



10-Piece  
Stainless Steel  
Cookware Set | CWSETL-ST-10



10-Piece Stainless  
Steel and Ceramic  
Cookware Set | CWSETL-NS-10



5-Piece Black  
Matte Enameled  
Cast Iron Set | CWSETS-BLM-5



5-Piece White  
Matte Enameled  
Cast Iron Set | CWSETS-WM-5

## CONTACT INFORMATION



### PHONE

**Customer Service**  
1-614-777-5004

**Dealer Assistance**  
1-833-597-2461



### HOURS OF OPERATION

**Customer Service**  
Monday–Friday 6:00am–4:30pm CST

**Dealer Assistance**  
Monday–Friday 7:00am–4:00pm CST



### EMAIL

**Customer Service**  
contact@zlinekitchen.com

**Dealer Assistance**  
dealer@zlinekitchen.com