







ASSEMBLY INSTRUCTION

1216-BENCH

HARDWARE LIST			
A		FLAT WASHER Ø5/16"*22	8pcs
B		SPRING WASHER Ø5/16"	8pcs
C		JCBC Ø5/16"*2"	8pcs
D		M5 ALLEN KEY	1pc

PARTS			
1		SEAT	1pc
2		LEG	4pcs

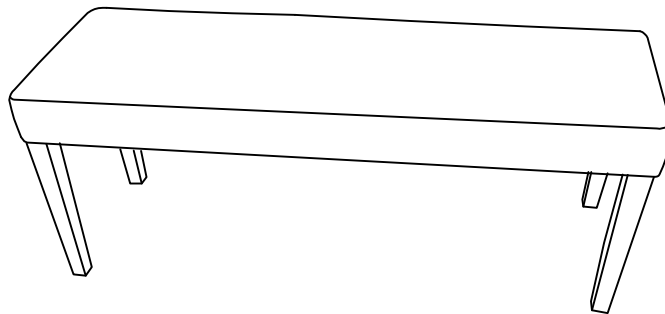
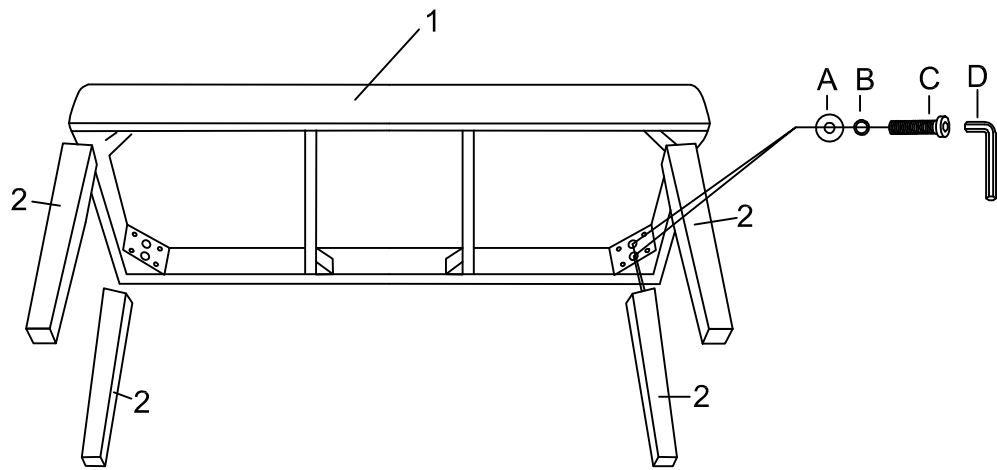

Do not tighten screws until completely assembled

Page 1 of 1

MADE IN VIETNAM