

See-Through Mobile Viewer

# MOVERIO

**BT-100**

User's Guide

Guide de l'utilisateur

Manual de usuario

Manual do Utilizador

**EPSON**  
EXCEED YOUR VISION

**EN** User's Guide p 01

---

**FR** Guide de l'utilisateur p 19

---

**ES** Manual de usuario p 36

---

**PT** Manual do Utilizador p 53

---

See-Through Mobile Viewer

# MOVERIO

BT-100



## **EN** User's Guide

Thank you very much for purchasing this product.  
Your gateway to a freer and more comfortable entertainment experience!

---

### **Before Use**

Make sure you read this guide carefully to use the product safely.  
After you have read all instructions, save this information for later reference.

Contents .....	02	Wearing the Headset .....	10
 Safety Instructions		Viewing Tips .....	12
Notes on Usage .....	04	 Basic Operations	
 Getting Ready		Using the Controller .....	13
Checking the Package Contents .....	07	Using the Home Screen .....	15
Charging .....	08	Connecting to the Internet .....	16
Turning on .....	09	Importing Data .....	17
		Trademarks & Customer Service .....	18

## Safety Instructions

The following warning symbols are used in this guide to indicate possible dangerous operations or handling.

Make sure you understand these warnings before reading this guide.

### ■ Safety symbols



#### Warning

This symbol indicates information that, if ignored, could possibly result in serious personal injury or even death due to incorrect handling.



#### Caution

This symbol indicates information that, if ignored, could possibly result in personal injury or physical damage due to incorrect handling.

### ■ General information symbols



Indicates procedures which may result in damage or injury if sufficient care is not taken.



Indicates additional information and points which may be useful to know regarding a topic.

## **Important Safety Instructions**

Follow these safety instructions when setting up and using the see through mobile viewer:

- Read these instructions.
- Keep these instructions.
- Heed all warnings.
- Follow all instructions.
- Do not use this apparatus near water.
- Clean only with dry cloth.
- Use this product in accordance with the manufacturer's instructions.
- Do not use the product near any heat sources such as radiators, heat registers, stoves, or other apparatus (including amplifiers) that produce heat.
- Do not defeat the safety purpose of the polarized or grounding-type plug. A polarized plug has two blades with one wider than the other. A grounding type plug has two blades and a third grounding prong. The wide blade or the third grounding prong are provided for your safety. If the provided plug does not fit into your

outlet, consult an electrician for replacement of the obsolete outlet.

- Protect the power cord from being walked on or pinched particularly at plugs, convenience receptacles, and the point where they exit from the apparatus.
- Only use attachments/accessories specified by the manufacturer.
- Unplug this apparatus during lightning storms or when unused for long periods of time.
- Refer all servicing to qualified service personnel. Servicing is required when the apparatus has been damaged in any way, such as the power-supply cord or plug is damaged, liquid has been spilled or objects have fallen into the apparatus, the apparatus has been exposed to rain or moisture, does not operate normally, or has been dropped.
- This product shall not be exposed to excessive heat such as sunshine, fire or the like.

 **Warning** Risk of fire, electric shock, or accident

Only use this product at the stated power-supply voltage.

Only use the USB cable and AC adapter supplied.

Do not use the supplied AC adapter with any other device.

Note the following points when handling the AC adapter.

- Do not plug the AC adapter into an outlet being used by many other devices.
- Do not plug in the AC adapter if there are any foreign objects such as dust stuck to it.
- Plug in the AC adapter securely.

- Do not hold the AC adapter with wet hands.
- Do not unplug the AC adapter by pulling on its cable.

Note the following points when handling the power cable (the microUSB cable supplied).

- Do not use the cable if it is damaged.
- Do not modify the cable.
- Do not place heavy objects on the cable.
- Do not bend, twist, or pull the power cable excessively.
- Do not place the wire near an electrical heater.

Do not use the product in locations where it may get wet or be subject to humidity such as in the rain or in a bath or shower. Do not place containers containing water, chemicals, or other liquids near this product.



---

Do not place this product in locations subject to smoke, steam, high humidity, or dust such as kitchen counters or near humidifiers.

---

Do not touch the AC adapter during a thunderstorm.

---

Do not disassemble or remodel this product (including consumable items).

---

In the following situations, turn off this product immediately, unplug the AC adapter, and contact an authorized Epson dealer.

- If you see smoke, or notice any strange odors or noises.
- If any water or foreign objects get into the product.
- If the product was dropped or the case was damaged.

---

 **Warning**    **Risk of deformation due to fire or heat**

---

Do not leave this product in locations subject to extremely high

temperatures such as cars with the windows closed, in direct sunlight, or in front of air-conditioning or heater outlets.

---

 **Warning**    **Risk of fire or burns**

---

Do not cover this product or the AC adapter with a cloth or similar material during use.

---

 **Warning**    **Risk of malfunction or electric shock**

---

Do not clean this product with a wet cloth or solvents such as alcohol, benzene, or thinner.

---

 **Warning**    **Risk of hearing impairment**

---

Do not start using this product at a high volume.



Permanent hearing loss may occur if earphones or headphones are used at high volume for prolonged periods of time.

---

**Warning Risk of injury or poisoning**

Do not disassemble or remodel this product.

Do not wear this product when driving, cooking, or performing any other dangerous tasks.

---

**Warning Risk of interference with other electronic devices**

Check that there is no medical equipment in the area before use as this product may cause electromagnetic interference on medical equipment or cause the equipment to malfunction.

---

When taking this product into areas in which the use of electromagnetic waves is prohibited, such as on aircraft or in hospitals, turn off this product or disable the wireless LAN function.

---

Note the following points when using the wireless LAN in medical institutions.

- Do not bring this product into operating rooms, Intensive Care Units (ICUs), or Cardiac Care Units (CCUs).
- When on wards, turn off this product or stop the electromagnetic waves.
- Even when not on wards, turn off this product or stop the electromagnetic waves if there is any electronic medical equipment in the area.
- Follow any rules stipulated by medical institutions that prohibit the use of devices emitting electromagnetic waves, or that prohibit entry to certain areas with such devices.

---

If you have an implanted pacemaker or implanted defibrillator, make sure you keep a distance of at least 22 cm between this product and the implanted device when using the wireless LAN. Before use, make sure that there is no one with a pacemaker near you, and if you are in a crowded location such as a train, turn off this product or stop the electromagnetic waves.

---

Do not use this product near automatically controlled devices such as automatic doors or fire alarms because it may cause electromagnetic interference which could cause an accident to occur or the devices to malfunction.

---

In locations where usage is restricted, such as on aircraft or in hospitals, follow the on-site rules (such as airplane announcements).

---

 **Caution**    **Risk of fire, electric shock, or accident**

---

For safety reasons, when you have finished using this product, make sure you turn it off.

---

When performing maintenance, make sure you unplug the AC adapter and disconnect all wires.

---

 **Caution**    **Risk of burns**

---

Do not touch the hot sections of the AC adapter for a while after use.

---

Do not use this product for extended periods of time if the controller is touching any part of your skin.

 **Caution** Risk of impaired vision

---

When wearing this product, do not look directly at the sun or at any bright lights.

 **Caution** Risk of damage or malfunctions

---

Do not place this product in locations subject to vibrations or impacts.

Do not use or store this product in locations subject to high or low temperatures. Also, avoid locations subject to sudden changes in temperature.

Do not place this product near high-voltage lines or magnetized items.

 **Caution** Risk of deterioration in image quality

---

Do not use or store this product in locations subject to smoke.

 **Caution** Risk of injury or feeling sick

---

Do not drop this product or treat it with unnecessary force.

When wearing this product, please be aware of the edges of the frame.

Do not place your finger between the moving parts of this product, such as the hinges.

Make sure you are wearing this product correctly.

Do not carry this product by its cable.

---

This product should only be used for viewing images.

---

If a problem or malfunction occurs, stop using this product immediately.

---

Stop using this product if your skin feels unusual when wearing this product.

---

Always take periodic breaks when viewing images using this product.

---

If you feel fatigued or uncomfortable when viewing with this product, stop viewing immediately.

---

Do not place any breakable or fragile objects in your immediate surroundings when using this product.

---

Only wear this product when viewing images. Do not move around while wearing this product.

---

---

Do not use this product if you are sensitive to light, or feel sick.

---

Children (especially under elementary school age) should not use this product as their eyesight is still developing.

---

 **Caution**    **Risk of injury or poisoning**

---

Contact an authorized Epson dealer when replacing batteries.

---

Dispose of this product in accordance with your local laws and regulations.

---

Check that all items are included.

Headset (including lens shade and nose pad)

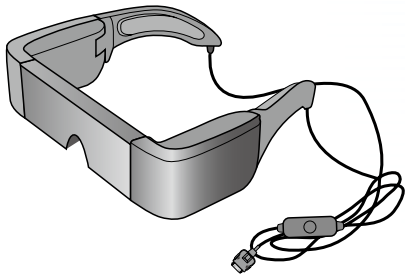

Controller



USB cable (1.4 m)

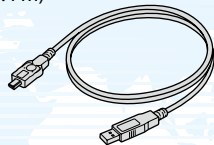

AC adapter

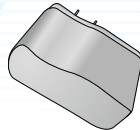

- microSDHC card (sample)



- Hooks for eyeglasses

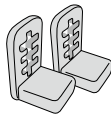

- Carrying case

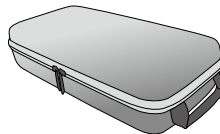

- Earphones (L and R)

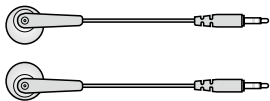

- Replacement nose pad (x2)



- User's Guide (this guide)

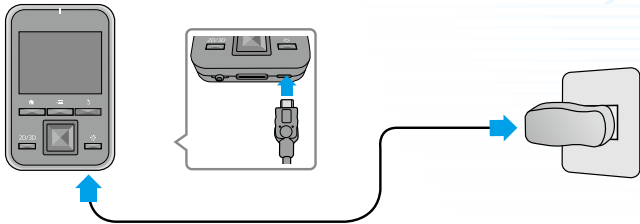

**1** Connect the controller and AC adapter.

Connect the controller and the AC adapter with the USB cable.

Plug in the AC adapter.

**Standard charge**

- Initial charging takes approximately 5 hours.
- The LED indicator turns orange while charging.
- The LED indicator turns green when charging is complete.



## 2 When charging is complete, remove the AC adapter.



- The battery is not fully charged at the time of purchase. Charge the battery before using this product.
- Battery life is approximately 6 hours. Battery life may vary depending on the usage conditions and the operating environment.

- The amount of battery remaining is displayed at the top of the Home screen.

	The battery is full
	The battery is running low
	The battery needs to be charged

- The LED indicates the following status.

Green	Operating / Charging complete
Flashing green	Starting up / Shutting down
Orange	Charging
Flashing red	The battery is running low
Flashing red five times	Insufficient battery to start up
Blue	Sleep mode

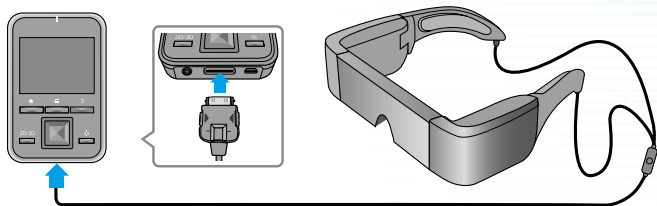
**1** Connect the headset and the controller.

Insert the headset's connection cable into the controller's headset connection port until it clicks.

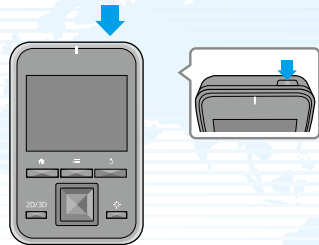
**2** Turn it on.

Press the [⏻] power button on the top of the controller for at least two seconds.  
The LED indicator turns green indicating the power is on.

## Turning Off

1. Press the [⏻] power button for at least two seconds.  
The [Device options] menu is displayed.
2. Select [Power off] - [OK].

Pressing the [⏻] power button for less than two seconds turns sleep mode on or off.



Some electricity is consumed even when the power is off.

- 1 Put on the headset and make adjustments so that you can see the whole screen.**

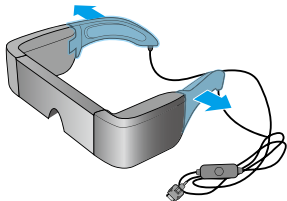

Use both hands to open the arms, and then put on the headset.  
(The connection cable goes behind your ears.)



Do not use too much force when opening the arms of the headset.

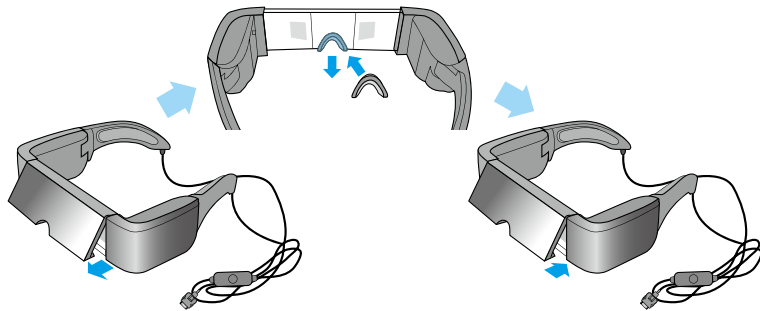

If you cannot view the top or bottom of the screen, remove the lens shade and replace the nose pad.

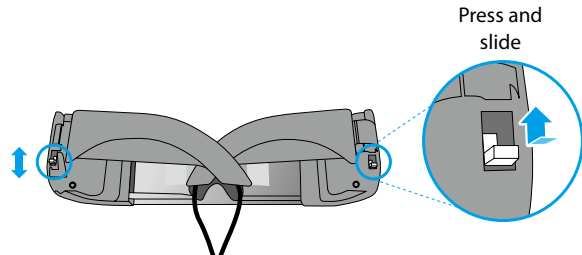

As shown in the illustration above, use the switches to widen the arms to fit your head.  
(The switches allow you to adjust the width in three stages with the widest setting at the top and the narrowest at the bottom.)

## Wearing the headset over glasses

1. Remove the nose pad from the headset.
2. Attach the glasses hooks to the left and right of the headset.
3. While wearing your glasses, lower the headset from the top of your head to put it on. The headset is supported by the glasses hooks resting on the frame of your glasses.

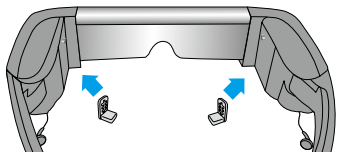

If the screen height is not correct, try adjusting the position of the glasses hooks.

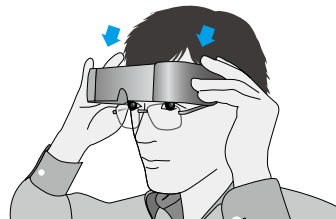
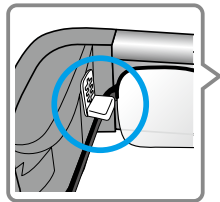

- Depending on the shape of your glasses, you may not be able to wear the headset.
- You cannot wear the headset over glasses wider than 147 mm.
- You can use the replacement nose pad instead of the glasses hooks when wearing the headset over glasses.

## 2 Wear the earphones.

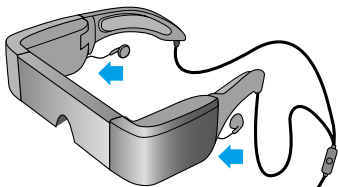

Connect the earphones supplied to the left and right of the headset.

If you have your own earphones, connect them to the controller's headphone port and unplug the earphones that came with the product.



Only connect earphones to this port. Do not connect any other devices.



- Remove the earphones from your ears when connecting or disconnecting the earphones. If you disconnect the earphones while listening to music or playing a movie, you may hear some noise, however this is not a malfunction.
- While wearing the headset, do not touch the screen display section. Fingerprints and so on cause the image quality to deteriorate. If the image display section becomes dirty, wipe it gently with a commercially available glass cleaner.

## Watching the Screen

Your view of the screen size changes depending on the location of your point of view. If your point of view is in the distance, it will feel as if the screen size is in the distance and larger.

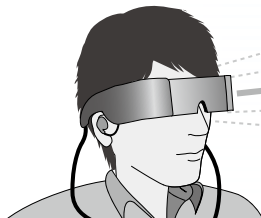

Approx. 2.5 m  
for 40 inch

Approx. 5 m  
for 80 inch



## Viewing Environment

How an image is perceived may vary depending on the brightness of your surroundings.



### Caution

It is difficult to see all of your surroundings while viewing with the product. Do not leave any fragile items in your immediate surroundings, and do not move around while wearing the headset.



- How an image is perceived varies depending on the individual.
- If there is a difference between the strength of your eyesight in your left and right eyes, you may not be able to view 3D contents correctly.

### BACK key

Displays the previous screen.

### MENU key

- Displays available menus for the current screen.
- Shows or hides the keyboard if held down during text input.

### microSD card slot

Insert the microSD card.

### Power button

Press for at least two seconds to turn on.  
When the power is on:

- Press and hold: Turns off the power;  
Turns on/off Airplane mode
- Short press: Turns on/off Sleep mode

### Volume key

Displays the volume screen allowing you to adjust the volume.

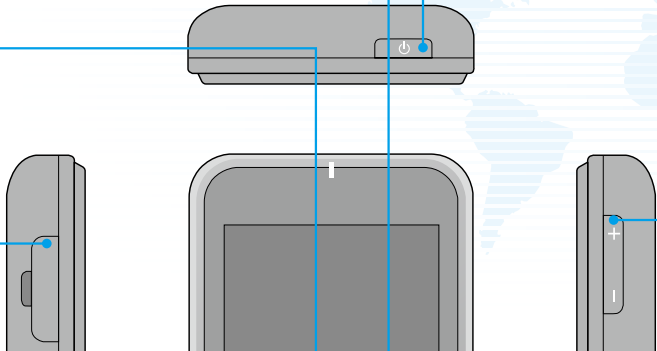



HOME key

A short press returns you to the Home screen. Press and hold to display recently used applications.

2D/3D key

Changes between 2D and 3D mode.

Direction keys

- Moves the selection area up, down, left, or right.
- Scrolls the page.

Key lock switch

Move the switch to the bottom to prevent accidental operations.

Brightness key

Displays the brightness screen allowing you to adjust the brightness.

Enter key

Makes selections or confirms your choices.

## Using the trackpad



Trackpad

When you touch the trackpad with your finger, a pointer is displayed on the screen.

Touching the trackpad for about one second enlarges the pointer, allowing you to drag.

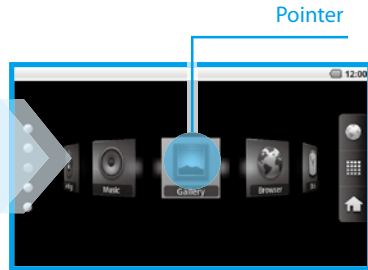

Pointer

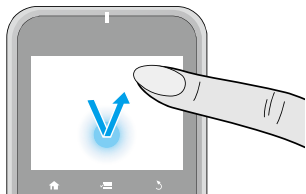

#### ■ Clicking

Move the pointer to an icon or display item, and then tap the trackpad.

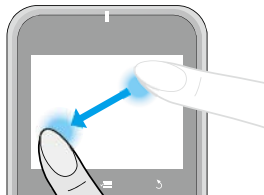

#### ■ Dragging

Touch the track pad for about one second to select the icon or display item, and then drag your finger on the trackpad to move it.

#### **Mute button**

Press the Mute button on the headset's connection cable to mute the image and audio.

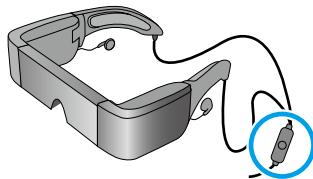

## Unlocking



Drag the [  ] up.

## Home screen icons

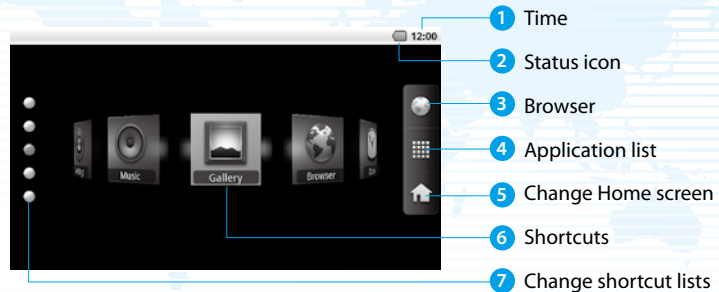







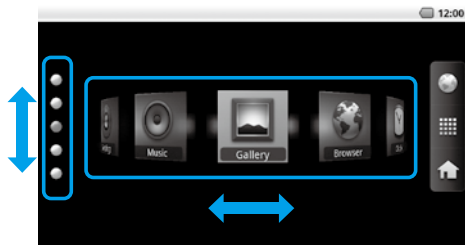



- 1 Time
- 2 Status icon
- 3 Browser
- 4 Application list
- 5 Change Home screen
- 6 Shortcuts
- 7 Change shortcut lists

## Launching an application from a shortcut

Use the Direction keys to select a shortcut, and then press the Enter key.

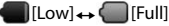

## Status bar icons

	Playing music		Dolby Mobile On
	Communicating via USB		Alarm set
	Connecting/using wireless LAN		Airplane mode
	Scanning microSD card		Unmounting microSD card
	Battery status		Charging
	Download complete		

You can access the Internet over a wireless LAN network.

**1** Enable wireless LAN, and then search for available networks.

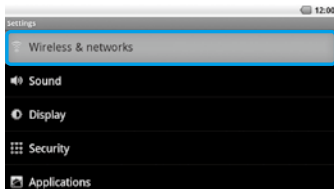

Launch [Settings] from the Home screen, and then select [Wireless & networks].

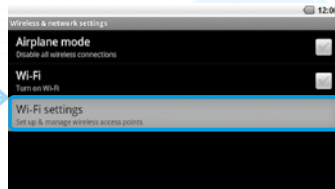

Select [Wi-Fi settings].

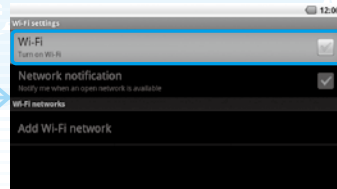

Select [Wi-Fi].



**2** Connect to one of the displayed wireless LAN networks.

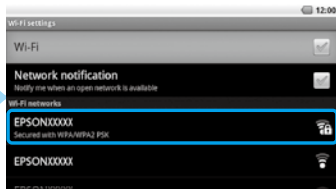

Select the network you want to connect to from [Wi-Fi networks].

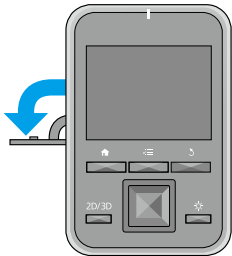

- If you select a security enabled network, you need to enter a password.
- You can add a network manually if the network you want to connect to is not found. For more details, see the digital user's guide.

**1** Insert the microSD card into the controller.

Open the cover in the direction shown by the arrow.

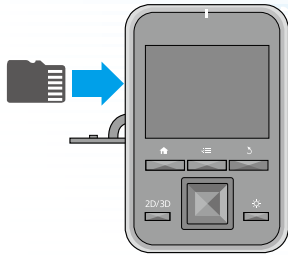

Slide the card into the slot until it clicks into place.

**Removing the microSD card**

1. Launch [📁] from the Home screen, and then select [SD card & device storage] - [Unmount SD card]. The SD card can now be removed.
2. Open the cover, press the microSD card once in the direction shown by the arrow, and then remove the card.

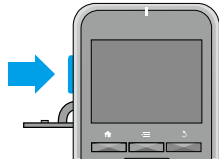

## 2 Copy data to the microSD card.

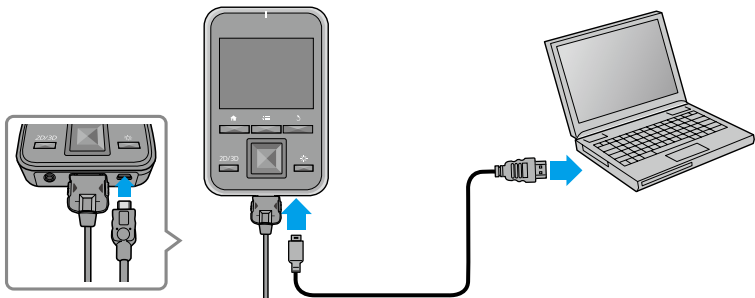

Connect the controller to your computer with the USB cable supplied to copy the data.



Do not remove the microSD card or turn off the power while copying data or accessing a file. Otherwise, the data could be corrupted.



- You can store up to 4GB of data on the microSDHC card supplied.
- This product supports microSDHC cards up to 32 GB.
- It may take a while to read large microSDHC cards.

### Digital User's Guide

A Digital User's Guide comes preinstalled with this product. When you want more detailed information, launch the Digital User's Guide from the Home screen.

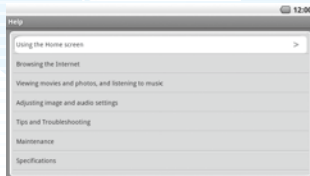
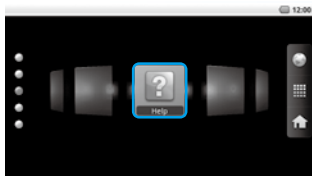

Use the Direction keys to select [ ? ], and then press the Enter key.

■ Trademarks



Manufactured under license from Dolby Laboratories.

Dolby and the double-D symbol are trademarks of Dolby Laboratories.

iWnnIME © OMRON SOFTWARE Co., Ltd. 2011 All Rights Reserved.

Contains Adobe® Flash® Player by Adobe Systems Incorporated.

Adobe Flash Player Copyright © 1996-2011, Adobe Systems incorporated. Adobe, Flash and the Flash logo are either registered trademarks or trademarks of Adobe Systems Incorporated in the United States and/or other countries.



microSDHC Logo is a trademark of SD-3C, LLC.

## ■ Customer Service

**Internet Support** <http://www.epson.com/>

---

### Notes Regarding Wireless LAN

Do not use the Wireless LAN function in France unless you are indoors.

If you purchase this product outside of North America, please note that this product emits wireless LAN electromagnetic waves on channels 1 to 13. Therefore, do not use the wireless LAN function in North America where wireless LAN channels are limited to 1 to 11 by the Wireless Telegraphy Act.

Follow local laws and regulations when using in other regions.

### Adobe Flash Player Restrictions

- Copying or distributing the software is strictly prohibited.
- Modifying or creating derivative works based on the software is strictly prohibited.
- Reverse engineering, decompiling, disassembling, or otherwise attempting to discover the source code of the software is strictly prohibited.
- We cannot accept liability claims due to indirect, special, incidental, exemplary, punitive, consequential, or other damages that may result from your use of this software.

See-Through Mobile Viewer

# MOVERIO

BT-100

## **FR** Guide de l'utilisateur

Nous vous remercions d'avoir acheté cet appareil.

Votre accès à un univers de loisirs plus libre et plus confortable !



---

### **Avant l'utilisation**

Assurez-vous de lire soigneusement ce guide pour utiliser l'appareil en toute sécurité.

Une fois avoir lu toutes les instructions, conservez ces informations comme référence.

# Table des matières

Table des matières .....	20	Porter les lunettes .....	27
 Instructions de sécurité		Conseils de visualisation .....	29
Remarques sur l'utilisation.....	21	 Opérations de base	
 Préparations		Utiliser le contrôleur .....	30
Vérifier le contenu de l'emballage.....	24	Utiliser l'écran d'accueil.....	32
Charger.....	25	Connecter à l'Internet.....	33
Allumer l'appareil .....	26	Importer des données .....	34
		Marques commerciales et service client.....	35



## Instructions de sécurité

Les symboles d'avertissement suivants sont utilisés dans ce guide pour indiquer des opérations ou des manipulations qui peuvent être dangereuses. Assurez-vous de bien comprendre ces avertissements avant de lire ce guide.

### ■ Symboles de sécurité



#### **Avertissement**

Ce symbole indique des informations dont le non-respect peut causer des blessures graves ou même mortelles dues à une manipulation incorrecte.



#### **Attention**

Ce symbole indique des informations dont le non-respect peut causer des blessures personnelles ou des dommages physiques dus à une manipulation incorrecte.

### ■ Symboles d'informations générales



Indique des procédures qui peuvent causer des dommages ou des blessures en cas de soins inadéquats.



Indique des informations et des remarques supplémentaires qui peuvent être utiles selon les rubriques.

 **Avertissement** Risque d'incendies, de chocs électriques, ou d'accidents

Utilisez l'appareil uniquement à la tension d'alimentation indiquée.

Utilisez uniquement le câble USB et l'adaptateur secteur fourni.

N'utilisez pas l'adaptateur secteur fourni avec d'autres appareils.

Remarques sur l'utilisation de l'adaptateur secteur.

- Ne branchez pas l'adaptateur secteur dans une prise utilisée par de nombreux autres appareils.
- Ne branchez pas l'adaptateur secteur s'il est poussiéreux ou sale.
- Branchez l'adaptateur secteur fermement.
- Ne touchez pas l'adaptateur secteur avec des mains mouillées.
- Ne débranchez pas l'adaptateur secteur en tirant sur son câble.

Remarques sur l'utilisation du câble d'alimentation (le câble micro USB fourni).

- N'utilisez pas le câble s'il est endommagé.
- Ne modifiez pas le câble.
- Ne placez pas des objets lourds sur le câble.
- Ne tirez pas et ne pliez pas excessivement le câble.
- Ne placez pas le câble près d'un radiateur électrique.

N'utilisez pas l'appareil dans des emplacements où il pourrait être mouillé, par ex. sous la pluie ou dans une salle de bains. Ne placez pas des récipients contenant de l'eau, des produits chimiques, ou d'autres liquides près de l'appareil.

Ne placez pas l'appareil dans des emplacements sujets à de la fumée, de la vapeur, une humidité élevée, ou de la poussière, tels qu'un plan de travail

de cuisine ou près d'un humidificateur.

---

Ne touchez pas l'adaptateur secteur durant un orage.

---

Ne désassemblez pas et ne transformez pas l'appareil (y compris les articles consommables).

---

Dans les situations suivantes, éteignez l'appareil immédiatement, débranchez l'adaptateur secteur, et contactez un revendeur Epson autorisé.

- Si l'appareil émet de la fumée, des odeurs ou des bruits étranges.
- Si de l'eau ou des corps étrangers pénètrent dans l'appareil.
- Si vous avez laissé tomber l'appareil ou si le boîtier est endommagé.

 **Avertissement** Risque de déformations dues à un incendie ou de la chaleur

---

Ne laissez pas l'appareil dans des emplacements sujets à des températures

extrêmement élevées, comme des voitures avec les fenêtres fermées, directement au soleil, ou devant des sorties de radiateurs ou de systèmes de chaleur.

 **Avertissement** Risque d'incendies ou de brûlures

---

Ne recouvrez pas l'appareil ou l'adaptateur secteur avec un tissu ou un matériel similaire durant son utilisation.

 **Avertissement** Risque de dysfonctionnements ou de chocs électriques

---

Ne nettoyez pas l'appareil avec un chiffon mouillé ou des solvants tels que diluants, benzène et alcool.

 **Avertissement** Risque de perte auditive

---

N'utilisez pas cet appareil à un volume élevé.



A pleine puissance, l'écoute prolongée du baladeur peut endommager l'oreille de utilisateur.



**Avertissement**    **Risque de blessures ou d'empoisonnements**

Ne désassemblez pas et ne transformez pas l'appareil.

Ne portez pas l'appareil en conduisant, en faisant la cuisine, ou en effectuant toutes autres tâches dangereuses.



**Avertissement**    **Risque d'interférences avec d'autres appareils électroniques**

Vérifiez la présence d'appareils médicaux autour de vous, cet appareil pouvant causer des interférences électromagnétiques sur les appareils médicaux ou causer leur dysfonctionnement.

Si vous prenez cet appareil dans des zones dans lesquelles l'utilisation

des ondes électromagnétiques est interdite, telles que des avions ou des hôpitaux, éteignez l'appareil ou désactivez la fonction LAN sans fil.

---

Remarques sur l'utilisation du LAN sans fil dans des institutions médicales.

- N'apportez pas cet appareil dans des salles d'opération, des unités de soins intensifs (USI), ou des unités de soins coronariens (CCU).
- Dans des salles communes ou des chambres de malades, éteignez l'appareil ou arrêtez les ondes électromagnétiques.
- Même si vous n'êtes pas dans des salles communes ou des chambres de malades, éteignez l'appareil ou arrêtez les ondes électromagnétiques si des appareils médicaux électroniques sont présents.
- Respectez tous les règlements établis par les institutions médicales qui interdisent l'utilisation d'appareils émettant des ondes électromagnétiques, ou qui interdisent l'entrée dans certaines zones avec ces appareils.

---

Si vous avez un stimulateur ou un défibrillateur interne, assurez-vous

de garder une distance d'au moins 22 cm entre cet appareil et l'appareil interne lorsque vous utilisez le LAN sans fil. Avant l'utilisation, assurez-vous qu'aucune personne avec un stimulateur ne se trouve près de vous, et si vous êtes dans un endroit serré, comme dans un train, éteignez l'appareil ou arrêtez les ondes électromagnétiques.

---

N'utilisez pas cet appareil près d'appareils contrôlés automatiquement, tels que des portes automatiques ou des alarmes d'incendie, car il peut causer des interférences électromagnétiques qui pourraient provoquer un accident ou un dysfonctionnement de ces systèmes.

---

Dans des endroits où l'usage est restreint, comme des avions ou des hôpitaux, respectez les règlements en vigueur (tels que les annonces dans les avions).

 **Attention** Risque d'incendies, de chocs électriques, ou d'accidents

---

Pour des raisons de sécurité, assurez-vous d'éteindre l'appareil lorsque vous avez fini de l'utiliser.

---

Lorsque vous effectuez une maintenance de l'appareil, assurez-vous de débrancher l'adaptateur secteur et de déconnecter tous les câbles.

 **Attention** Risque de brûlures

---

Ne touchez pas les parties chaudes de l'adaptateur secteur directement après son utilisation.

---

N'utilisez pas l'appareil pour des périodes prolongées si le contrôleur touche une partie de votre peau.

 **Attention**    Risque de dommages oculaires

---

Lorsque vous portez l'appareil, ne regardez pas directement le soleil ou d'autres lumières intenses.

 **Attention**    Risque de dommages ou de dysfonctionnements

---

Ne placez pas l'appareil dans des endroits sujets à des vibrations ou des chocs.

N'utilisez pas ou ne stockez pas l'appareil dans des emplacements sujets à des températures élevées ou basses. Évitez aussi des emplacements sujets à des changements soudains de température.

Ne placez pas l'appareil près de lignes à haute tension ou d'objets aimantés.

 **Attention**    Risque de détérioration de la qualité de l'image

---

N'utilisez pas ou ne stockez pas l'appareil dans des emplacements sujets à de la fumée.

 **Attention**    Risque de blessures ou de malaises

---

Ne laissez pas tomber l'appareil et ne le manipulez pas avec une force excessive.

Lorsque vous portez l'appareil, veuillez tenir compte des bords de la monture des lunettes projecteur.

Ne placez pas les doigts entre les parties amovibles de l'appareil, telles que les charnières.

Assurez-vous de porter l'appareil correctement.

---

Ne transportez pas l'appareil par son câble.

---

Cet appareil doit être utilisé uniquement pour visualiser des images.

---

En cas de problème ou de dysfonctionnements, cessez immédiatement d'utiliser l'appareil.

---

Arrêtez d'utiliser l'appareil si vous éprouvez une sensation particulière sur votre peau lorsque vous portez les lunettes projecteur.

---

Faites toujours des pauses fréquentes lorsque vous visualisez des images avec l'appareil.

---

Si vous vous sentez fatigué ou indisposé lorsque vous visualisez des images avec cet appareil, cessez immédiatement.

---

Ne placez pas des objets fragiles ou cassables près de vous lorsque vous utilisez l'appareil.

---

---

Portez cet appareil uniquement lorsque vous visualisez des images. Ne vous déplacez pas lorsque vous portez l'appareil.

---

N'utilisez pas l'appareil si vous êtes sensible à la lumière, ou si vous vous sentez indisposé.

---

Les enfants (spécialement en dessous de l'âge d'école primaire) ne devraient pas utiliser cet appareil, leur acuité visuelle étant en cours de développement.

---

 **Attention**    **Risque de blessures ou d'empoisonnements**

---

Contactez un revendeur Epson autorisé pour remplacer les batteries.

---

Recyclez cet appareil en accord avec les lois et règlements locaux.

---

Vérifiez que tous les articles sont inclus.

Lunettes projecteur (avec viseur et plaquette nasale)

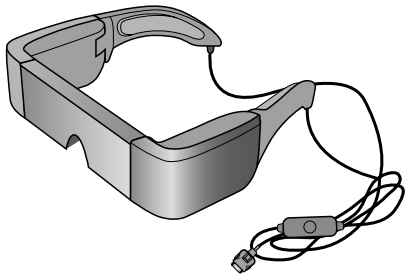

Contrôleur



Câble USB (1,4 m)

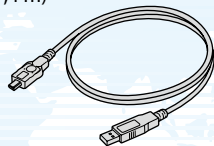

Adaptateur secteur

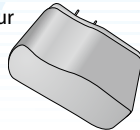



Carte microSDHC (échantillon)



Crochets pour lunettes de vue

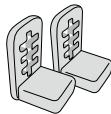

Étui de transport

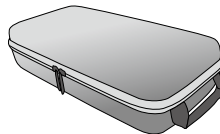

Écouteurs (G et D)

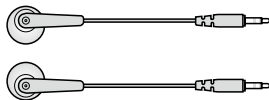

Plaquette nasale de recharge (x2)



Guide de l'utilisateur (ce guide)

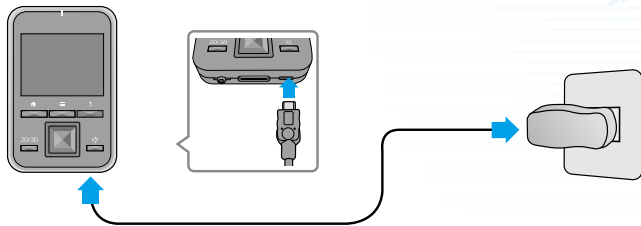

**1** Connectez le contrôleur, et l'adaptateur secteur.

Connectez le contrôleur et l'adaptateur secteur avec le câble USB.

Branchez l'adaptateur secteur.

**Charge standard**



- Le chargement initial prend environ 5 heures.
- Le voyant s'allume en orange durant le chargement.
- Le voyant s'allume en vert une fois le chargement terminé.

**2** Une fois le chargement terminé, retirez l'adaptateur secteur.



- La batterie n'est pas complètement chargée lors de l'achat. Chargez la batterie avant d'utiliser l'appareil.
- La durée de vie de la batterie est environ 6 heures. La durée de vie de la batterie peut varier selon les conditions d'utilisation et l'environnement d'opération.

- La charge restante de la batterie est affichée au sommet de l'écran d'accueil.

	La batterie est pleine
	La batterie est faible
	La batterie doit être rechargée

- Le voyant indique les états suivants.

Vert	Opération / chargement terminé
Vert clignotant	Démarrage / arrêt
Orange	Chargement en cours
Rouge clignotant	La batterie est faible
Rouge clignotant cinq fois	Niveau de batterie insuffisant pour démarrer
Bleu	Mode veille

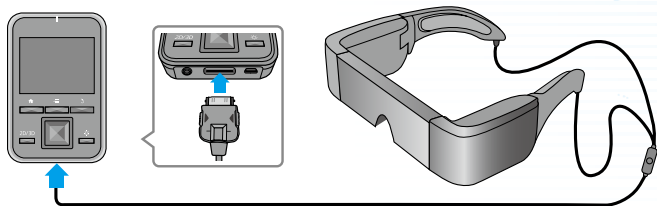
**1** Connectez les lunettes et le contrôleur.

Insérez le câble de connexion des lunettes dans le port lunettes du contrôleur jusqu'à ce qu'un clic soit audible.

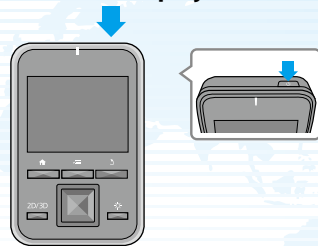
**2** Allumez les lunettes projecteur.

Appuyez au moins deux secondes sur la touche marche/arrêt [⏻] au sommet du contrôleur.  
Le voyant s'allume en vert pour indiquer que l'appareil est allumé.

## Éteindre

1. Appuyez au moins deux secondes sur la touche marche-arrêt [⏻]. Le menu [Options de l'appareil] est affiché.
2. Sélectionnez [Éteindre] - [OK].

.....  
Si vous appuyez moins de deux secondes sur la touche marche-arrêt [⏻], vous activez/désactivez le mode veille.



L'appareil consomme de l'électricité même lorsqu'il est éteint.

**1** Ajustez les lunettes afin de pouvoir visualiser tout l'écran.

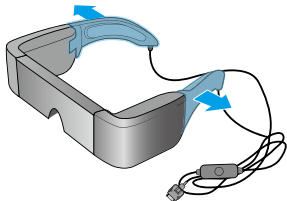

Utilisez les deux mains pour ouvrir les branches, et ajustez les lunettes en place.  
(Le câble de connexion passe derrière vos oreilles.)



N'utilisez pas trop de force lorsque vous ouvrez les branches des lunettes.

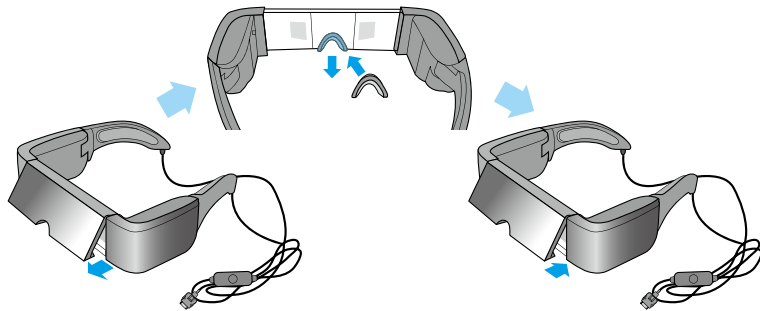

Si vous ne pouvez pas voir le sommet ou le fond de l'écran,  
retirez le viseur et remplacez la plaquette nasale.

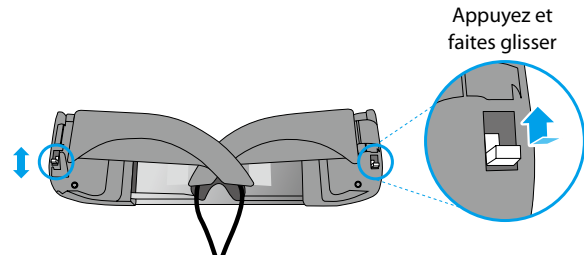

Comme indiqué dans l'illustration ci-dessus, utilisez les boutons  
pour agrandir les branches pour votre tête.  
(Trois niveaux de largeur sont possibles,  
du sommet (plus large) au fond (plus étroit).)

## Porter les lunettes projecteur sur des lunettes de vue

1. Retirez la plaquette nasale des lunettes projecteur.
2. Fixez les crochets de lunettes de vue sur la gauche et la droite des lunettes projecteur.
3. Placez les lunettes depuis le sommet de votre tête. Les crochets reposent sur les branches de vos lunettes de vue pour supporter les lunettes projecteur.

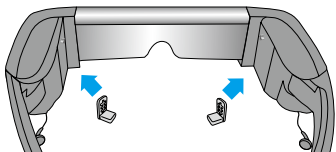

Si la hauteur de l'écran n'est pas correcte, essayez d'ajuster la position des crochets.

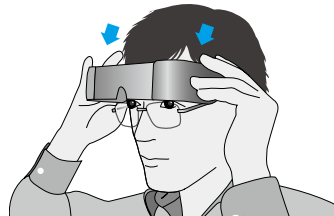
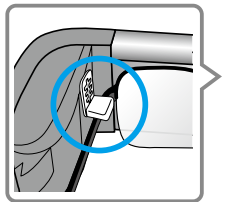

- Selon la forme de vos lunettes de vue, vous ne pourrez peut-être pas porter les lunettes projecteur.
- Vous ne pouvez pas porter les lunettes projecteur sur des lunettes de vue plus larges que 147 mm.
- Vous pouvez utiliser la plaquette nasale de rechange au lieu des crochets lorsque vous portez les lunettes projecteur sur des lunettes de vue.



## 2 Insérez gentiment les écouteurs.

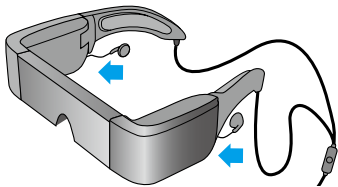

Connectez les écouteurs fournis sur la gauche et la droite des lunettes.

Si vous voulez utiliser vos écouteurs, connectez-les au port écouteurs du contrôleur et déconnectez les écouteurs livrés avec l'appareil.



Connectez uniquement les écouteurs à ce port. Ne connectez pas d'autres appareils.



- Lorsque vous connectez ou déconnectez les écouteurs, retirez-les de vos oreilles. Si vous déconnectez les écouteurs en écoutant de la musique ou en regardant une vidéo, du bruit peut être audible ; ceci n'est pas un dysfonctionnement.
- Lorsque vous portez les lunettes projecteur, ne touchez pas la section d'affichage de l'écran. Les empreintes de doigts et d'autres traces peuvent causer une détérioration de la qualité de l'image. Si la zone d'affichage est sale, essayez-la gentiment avec un nettoyant pour vitres disponible dans le commerce.

## Regarder l'écran

Votre vue de la taille de l'écran change selon la position de votre point de vue.  
Si votre point de vue est éloigné, la taille de l'écran semblera à distance et plus large.

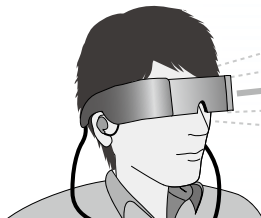

Environ 2,5 m  
pour 40 pouces

Environ 5 m  
pour 80 pouces

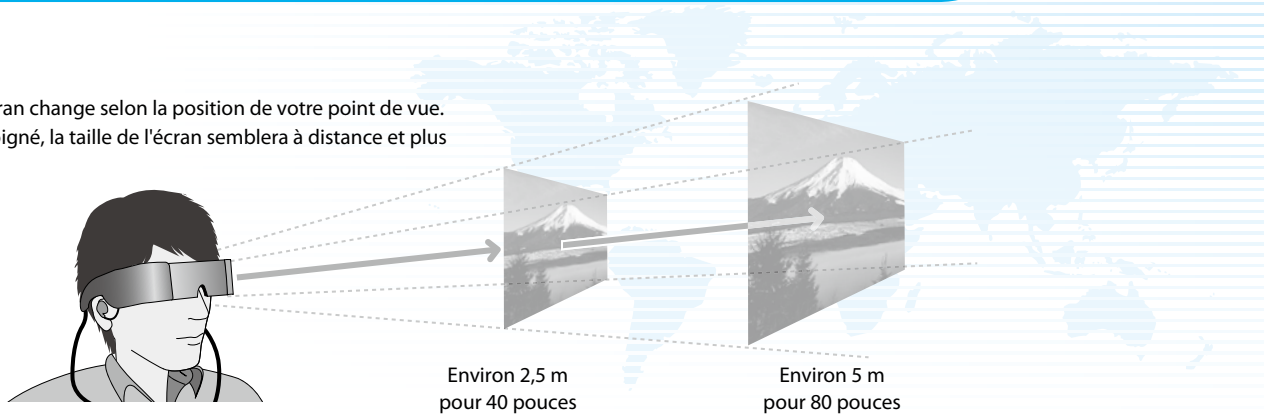

## Environnement de visualisation

La perception des images peut varier selon la luminosité de votre environnement.



### Attention

Il est difficile de voir votre environnement lorsque vous visualisez des images avec l'appareil. Ne gardez pas des objets fragiles autour de vous, et ne vous déplacez pas lorsque vous portez les lunettes.



- La perception des images varie selon les personnes.
- En cas de différence d'acuité visuelle entre votre œil gauche et droit, vous ne pourrez peut-être pas visualiser correctement des images 3D.

## Touche RETOUR

Affiche l'écran précédent.

## Touche MENU

- Affiche les menus disponibles pour l'écran actuel.
- Affiche ou masque le clavier si enfoncée durant l'entrée de texte.

## Fente de la carte microSD

Insérez une carte microSD.

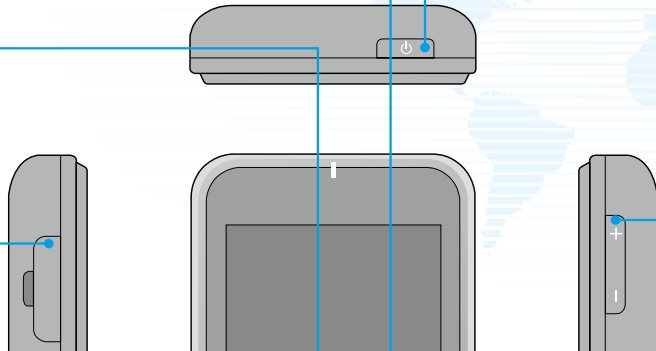

## Touche marche/arrêt

Appuyez au moins deux secondes pour allumer l'appareil. Lorsque l'appareil est allumé :

- Appuyer et maintenir : Éteint l'appareil ; Active/désactive le mode avion
- Appuyer : Active/désactive le mode veille

## Touche de volume

Permet d'ajuster le volume.

## Touche ACCUEIL

Appuyez une fois pour retourner à l'écran d'accueil. Appuyez et maintenez pour afficher les applications utilisées récemment.

## Touche 2D/3D

Passe entre les modes 2D et 3D.

## Touches de direction

- Déplace la zone de sélection vers le haut, le bas, la gauche, ou la droite.
- Défile la page.

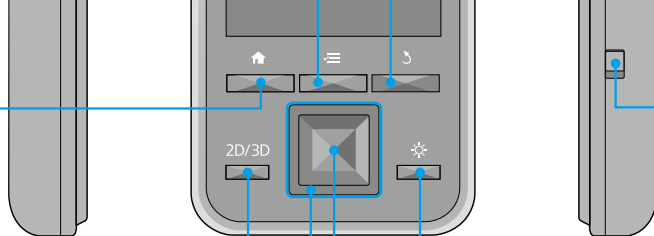

## Bouton de verrouillage des touches

Déplacez le verrou vers le bas pour prévenir des opérations accidentelles.

## Touche de luminosité

Permet d'ajuster la luminosité de l'écran.

## Touche Enter

Effectue des sélections ou confirme vos choix.

## Utiliser le pavé tactile



Pavé tactile

Lorsque vous touchez le pavé tactile avec votre doigt, un pointeur est affiché sur l'écran.

Toucher le pavé tactile environ une seconde agrandit le pointeur, permettant de déplacer des éléments.

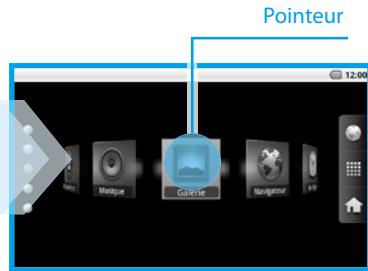

Pointeur

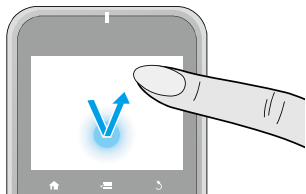

#### ■ Cliquer

Déplacez le pointeur sur une icône ou un élément affiché, puis appuyez sur le pavé tactile.

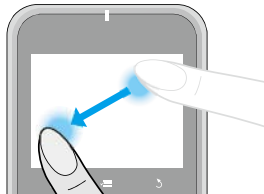

#### ■ Déplacer

Touchez le pavé tactile environ une seconde pour sélectionner l'icône ou l'élément affiché, puis déplacez votre doigt sur le pavé tactile.

### Bouton Muet

Appuyez sur le bouton Muet sur le câble de connexion des lunettes pour couper l'image et le son.

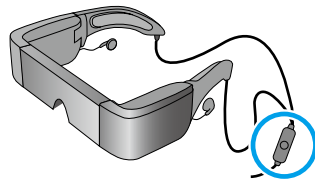

### Déverrouiller



Déplacez [  ] vers le haut.

### Icônes de l'écran d'accueil



- 1 Heure
- 2 Icône d'état
- 3 Navigateur
- 4 Liste des applications
- 5 Modifier l'écran d'accueil
- 6 Raccourcis
- 7 Modifier les listes de raccourcis







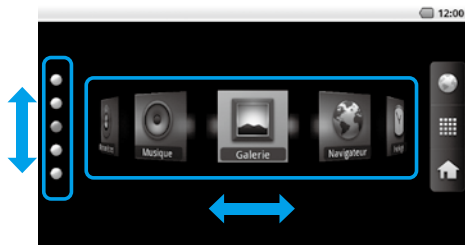





## Lancer une application à partir d'un raccourci

Utilisez les touches de direction pour sélectionner un raccourci, puis appuyez sur la touche Enter.



## Icônes de la barre d'état

	Musique en cours		Dolby Mobile activé
	Communication via USB		Alarme réglée
	Connexion/utilisation du LAN sans fil		Mode avion
	Balayage de la carte microSD		Démontage de la carte microSD
 [Faible] ↔ [Pleine]	État de la batterie		Chargement en cours
	Téléchargement terminé		

Vous pouvez accéder à l'Internet via un réseau LAN sans fil.

**1** Activez le LAN sans fil, puis recherchez les réseaux disponibles.

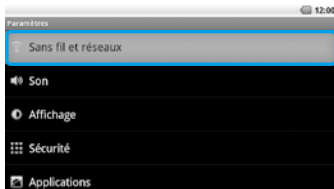

Lancez [App Store] de l'écran d'accueil, puis sélectionnez [Sans fil et réseaux].

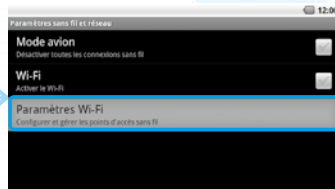

Sélectionnez [Paramètres Wi-Fi].

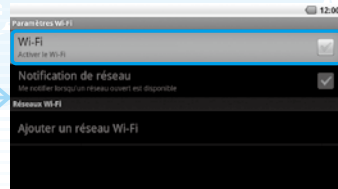

Sélectionnez [Wi-Fi].

## 2 Connectez à un des réseaux LAN sans fil affichés.

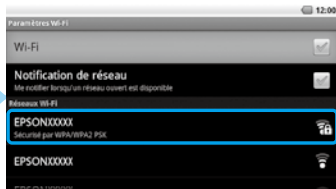

Sélectionnez le réseau auquel vous voulez vous connecter sous [Réseaux Wi-Fi].



- Si vous sélectionnez un réseau sécurisé, vous devez entrer un mot de passe.
- Vous pouvez ajouter un réseau manuellement, si le réseau auquel vous voulez vous connecter n'est pas détecté. Pour plus de détails, voir le guide de l'utilisateur en-ligne.

**1** Insérez la carte microSD dans le contrôleur.

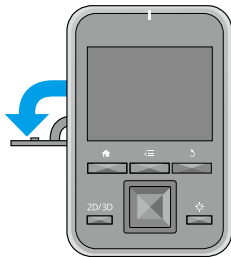

Ouvrez le couvercle dans la direction indiquée par la flèche.

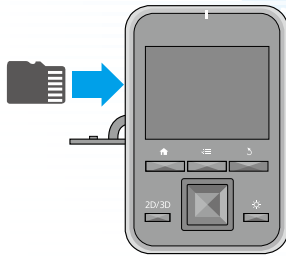

Insérez la carte dans la fente jusqu'à ce que vous entendiez un clic.

**Retirer la carte microSD**

1. Lancez [⊕] de l'écran d'accueil, puis sélectionnez [Carte SD et mémoire de l'appareil] - [Désactiver la carte SD]. La carte SD peut-être maintenant retirée.
2. Ouvrez le couvercle, appuyez une fois sur la carte microSD dans la direction indiquée par la flèche, puis retirez la carte.

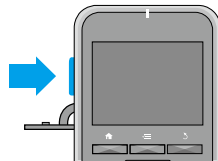

## 2 Copiez les données sur la carte microSD.

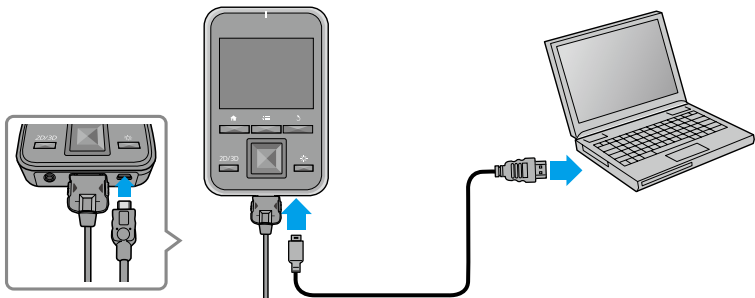

Connectez le contrôleur à votre ordinateur à l'aide du câble USB fourni pour copier les données.



Pour éviter d'endommager les données, ne retirez pas la carte microSD ou n'éteignez pas l'appareil durant la copie de données ou l'accès à un fichier.



- Vous pouvez stocker jusqu'à 4 Go de données sur la carte microSDHC fournie.
- Cet appareil prend en charge des cartes microSDHC jusqu'à 32 Go.
- La lecture de cartes microSDHC de haute capacité peut prendre un certain temps.

## Guide de l'utilisateur en-ligne

Un guide de l'utilisateur en-ligne est préinstallé avec le produit. Pour obtenir plus d'informations, lancez l'application le guide de l'utilisateur en-ligne à partir de l'écran d'accueil.



Utilisez les touches de direction pour sélectionner [ ? ], puis appuyez sur la touche Enter.

■ Marques commerciales



Fabriqué sous licence de Dolby Laboratories.

Dolby et le symbole double-D sont des marques déposées de Dolby Laboratories.

iWnnIME © OMRON SOFTWARE Co., Ltd. 2011 All Rights Reserved.

Contains Adobe® Flash® Player by Adobe Systems Incorporated.

Adobe Flash Player Copyright © 1996-2011, Adobe Systems incorporated. Adobe, Flash and the Flash logo are either registered trademarks or trademarks of Adobe Systems Incorporated in the United States and/or other countries.



microSDHC Logo is a trademark of SD-3C, LLC.

## ■ Service client

**Support Internet** <http://www.epson.com/>

---

### Remarques sur le LAN sans fil

N'utilisez pas la fonction LAN sans fil en France si vous n'êtes pas à l'intérieur.

Si vous achetez cet appareil en dehors de l'Amérique du Nord, veuillez noter que cet appareil émet des ondes électromagnétiques LAN sans fil sur les canaux 1 à 13. Par conséquent, n'utilisez pas la fonction LAN sans fil en Amérique du Nord où les canaux LAN sans fil sont limités de 1 à 11 par la loi « Wireless Telegraphy Act ».

Respectez les lois et les règlements locaux en cas d'utilisation dans d'autres régions.

### Restrictions d'Adobe Flash Player

- La copie ou la distribution du logiciel est strictement interdite.
- La modification ou la création de travaux dérivés basés sur le logiciel est strictement interdite.
- L'ingénierie inversée, la décompilation, le désassemblage, ou toute autre méthode de détection du code source du logiciel est strictement interdite.
- Nous ne pouvons pas accepter des réclamations de responsabilité en cas de dommages indirects, spéciaux, accessoires, exemplaires, punitifs, secondaires, ou tout autre dommage qui pourrait résulter de votre utilisation de ce logiciel.



See-Through Mobile Viewer

# MOVERIO

BT-100

## **ES** Manual de usuario

Gracias por adquirir este producto.



Con él disfrutará de una experiencia de entretenimiento más cómoda y con mayor libertad.

---

### **Antes del uso**

Lea detenidamente este manual para utilizar el producto con seguridad.

Después de leer todas las instrucciones, guarde esta información para su posterior consulta.

Contenido .....	37	Ponerse las gafas-proyector .....	44
 Instrucciones de seguridad		Consejos de visualización.....	46
Notas sobre el uso.....	38	 Operaciones básicas	
 Preparación		Usar el mando.....	47
Comprobar el contenido del paquete .....	41	Usar la pantalla de inicio.....	49
Cargar .....	42	Conectarse a Internet .....	50
Encender.....	43	Importar datos.....	51
		Marcas comerciales y servicio al cliente.....	52

## Instrucciones de seguridad

Los siguientes símbolos de advertencia se utilizan en este manual para indicar posibles operaciones o manipulaciones peligrosas.

Asegúrese de comprender estas advertencias antes de leer este manual.

### ■ Símbolos de seguridad



#### **Advertencia**

Este símbolo se aplica a información que, si se ignora, podría dar lugar a daños personales graves o incluso la muerte como consecuencia de una manipulación incorrecta.



#### **Precaución**

Este símbolo se aplica a información que, si se ignora, podría dar lugar a daños personales o lesiones físicas como consecuencia de una manipulación incorrecta.

### ■ Símbolos de información general



Indica procedimientos que pueden provocar averías o lesiones si no se realizan con el cuidado suficiente.



Indica información adicional y aspectos cuyo conocimiento puede resultar útil respecto a un tema.

 **Advertencia** Riesgo de incendio, descarga eléctrica o accidente

Utilice este producto únicamente con el voltaje de alimentación especificado.

Utilice únicamente el cable USB y el adaptador de CA suministrados.

No utilice el adaptador de CA suministrado con ningún otro dispositivo.

Tenga en cuenta lo siguiente al manipular el adaptador de CA.

- No enchufe el adaptador de CA en una toma de corriente en la que estén enchufados muchos otros dispositivos.
- No enchufe el adaptador de CA si tiene pegadas materias extrañas, como polvo.
- Enchufe el adaptador de CA firmemente.

- No sujete el adaptador de CA con las manos mojadas.
- No desenchufe el adaptador de CA tirando del cable.

Tenga en cuenta lo siguiente al manipular el cable de alimentación (el cable microUSB suministrado).

- No utilice el cable si está dañado.
- No modifique el cable.
- No coloque objetos pesados sobre el cable.
- No doble, enrolle ni tire del cable de alimentación en exceso.
- No coloque el cable cerca de un calentador eléctrico.

No utilice el producto en lugares donde pueda mojarse o estar expuesto a la humedad, como bajo la lluvia o en una bañera o ducha. No coloque cerca de este producto recipientes que contengan agua, productos

químicos u otros líquidos.

---

No coloque este producto en lugares expuestos a humo, vapor, polvo o altos niveles de humedad, como encimeras de cocina o cerca de humidificadores.

---

No toque el adaptador de CA durante una tormenta.

---

No desmonte ni modifique este producto (incluidos artículos consumibles).

---

En las situaciones siguientes, apague inmediatamente este producto, desenchufe el adaptador de CA y póngase en contacto con un distribuidor Epson autorizado.

- Si ve humo o percibe olores o ruidos extraños.
- Si se introduce agua u objetos extraños en el producto.
- Si el producto se cae o el maletín se daña.

---

 **Advertencia**    Riesgo de deformación debido a un incendio o al calor

---

No deje este producto en lugares expuestos a temperaturas extremadamente altas, como coches con las ventanillas cerradas, bajo la luz directa del sol, o delante de salidas de calentadores o aparatos de aire acondicionado.

---

 **Advertencia**    Riesgo de incendio o quemaduras

---

No cubra este producto ni el adaptador de CA con un paño o material similar durante su uso.

---

 **Advertencia**    Riesgo de mal funcionamiento o descarga eléctrica

---

No limpie este producto con un paño mojado ni con disolventes como alcohol, benceno o diluyente.

 **Advertencia**    **Riesgo de deficiencia auditiva**

---

No utilice este producto con un volumen inicial alto.

---



El uso de auriculares a alto volumen durante largos periodos de tiempo puede producir una pérdida auditiva permanente.

---

 **Advertencia**    **Riesgo de lesión o intoxicación**

---

No desmonte ni modifique este producto.

---

No lleve puesto este producto mientras conduce, cocina o realiza cualquier otra actividad peligrosa.

---

 **Advertencia**    **Riesgo de interferencia con otros dispositivos electrónicos**

---

Compruebe que no haya ningún instrumental médico en la zona antes

de su uso, ya que este producto puede producir en dicho instrumental interferencias electromagnéticas o un funcionamiento incorrecto.

---

Si lleva este producto a zonas en las que el uso de ondas electromagnéticas esté prohibido, como aviones u hospitales, apáguelo o deshabilite la función LAN inalámbrica.

---

Tenga en cuenta lo siguiente al utilizar la función LAN inalámbrica en centros sanitarios.

- No introduzca este producto en quirófanos, unidades de cuidados intensivos (UCI) o unidades coronarias (UC).
- Apague este producto o deshabilite las ondas electromagnéticas dentro de instalaciones hospitalarias.
- Incluso aunque no se encuentre en instalaciones hospitalarias, apague este producto o deshabilite las ondas electromagnéticas si hay algún instrumental médico electrónico en la zona.

- Respete las normas establecidas por los centros sanitarios que prohíban el uso de dispositivos emisores de ondas electromagnéticas o el acceso a determinadas áreas con dichos dispositivos.

---

Si tiene implantado un marcapasos o un desfibrilador, mantenga una distancia de al menos 22 cm entre este producto y el dispositivo implantado cuando utilice la función LAN inalámbrica. Antes de usarlo, compruebe que no haya nadie con marcapasos cerca de usted y, si se encuentra en un lugar concurrido como por ejemplo un tren, apague este producto o deshabilite las ondas electromagnéticas.

---

No utilice este producto cerca de dispositivos controlados automáticamente, como puertas automáticas o alarmas contra incendios, ya que puede producir interferencias electromagnéticas que pueden dar lugar a un accidente o un funcionamiento incorrecto de los dispositivos.

---

En los lugares donde su uso esté restringido, como aviones u hospitales, respete las normas correspondientes (tales como anuncios en los aviones).

---

 **Precaución**    **Riesgo de incendio, descarga eléctrica o accidente**

---

Por motivos de seguridad, apague este producto cuando haya terminado de usarlo.

---

Cuando realice labores de mantenimiento, desenchufe el adaptador de CA y desconecte todos los cables.

---

 **Precaución**    **Riesgo de quemaduras**

---

No toque las secciones calientes del adaptador de CA hasta pasado un rato después de su uso.

---

No utilice este producto durante largos periodos de tiempo si el mando está en contacto con alguna parte de su piel.

 **Precaución**    **Riesgo de deficiencia visual**

---

Cuando lleve puesto este producto, no mire directamente al sol o a luces intensas.

 **Precaución**    **Riesgo de avería o mal funcionamiento**

---

No coloque este producto en lugares expuestos a vibraciones o golpes.

---

No utilice ni almacene este producto en lugares expuestos a altas o bajas temperaturas. Evite también los lugares expuestos a cambios bruscos de temperatura.

---

No coloque este producto cerca de líneas de alta tensión u objetos imantados.

 **Precaución**    **Riesgo de deterioro de la calidad de imagen**

---

No utilice ni almacene este producto en lugares expuestos a humo.

 **Precaución**    **Riesgo de lesión o malestar**

---

No deje caer este producto ni lo manipule con fuerza innecesaria.

---

Cuando lleve puesto este producto, tenga presentes los bordes de la montura.

---

No ponga el dedo entre las partes móviles de este producto, como las articulaciones.



---

Asegúrese de ponerse este producto correctamente.

---

No transporte este producto agarrándolo por el cable.

---

Este producto sólo debe utilizarse para visualizar imágenes.

---

Si se produce un problema o un funcionamiento incorrecto, deje de usar este producto inmediatamente.

---

Deje de usar este producto si siente alguna sensación extraña en la piel mientras lo lleva puesto.

---

Tómese siempre descansos periódicos cuando visualice imágenes con este producto.

---

Si se siente cansado o incómodo mientras visualiza imágenes con este producto, deje de usarlo inmediatamente.

---

---

No coloque objetos frágiles cerca de usted cuando utilice este producto.

---

Póngase este producto únicamente para visualizar imágenes. No se mueva de un lado a otro mientras lleve puesto este producto.

---

No utilice este producto si es sensible a la luz o siente malestar.

---

Este producto no debe ser usado por niños (en especial niños por debajo de la edad escolar primaria), ya que su vista aún se está desarrollando.

---

### **Precaución**    **Riesgo de lesión o intoxicación**

---

Póngase en contacto con un distribuidor Epson autorizado cuando sustituya las baterías.

---

Deseche este producto de acuerdo con las leyes y reglamentos locales.

---

Compruebe que todos los elementos están incluidos.

- Gafas-proyector (incluyendo visera de lente y almohadilla para la nariz)

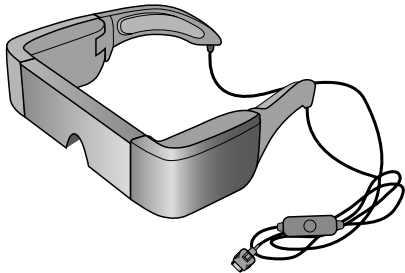

- Mando



- Cable USB (1,4 m)

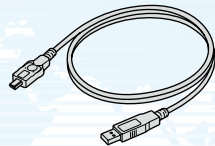

- Adaptador de CA

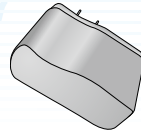

Tarjeta microSDHC (muestra)



Ganchos para gafas

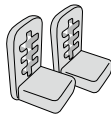

Maletín de transporte

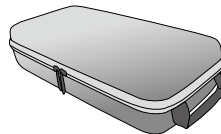

Auriculares (izquierdo y derecho)

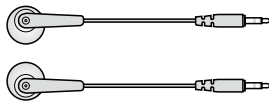

Repuesto de almohadilla para la nariz (×2)

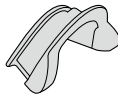

Manual de usuario (este manual)

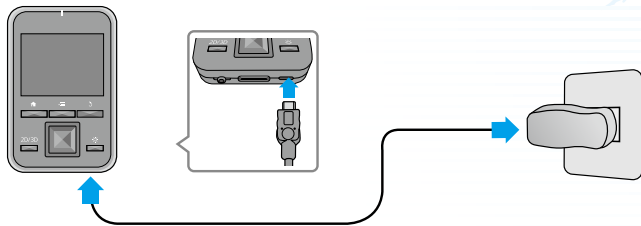

**1** Conecte el mando y el adaptador de CA.

Conecte el mando y el adaptador de CA con el cable USB.

Enchufe el adaptador de CA.

**Carga normal**

- La carga inicial tarda aproximadamente 5 horas.
- El LED indicador se ilumina en naranja durante la carga.
- El LED indicador se ilumina en verde cuando la carga se ha completado.

## 2 Una vez completada la carga, retire el adaptador de CA.



- La batería no está completamente cargada en el momento de la compra. Cargue la batería antes de usar este producto.
- La duración de la batería es de aproximadamente 6 horas. Esta duración puede variar en función de las condiciones de uso y del entorno operativo.

- En la parte superior de la pantalla de inicio se muestra la cantidad de batería restante.

	La batería está llena
	Queda poca batería
	La batería necesita cargarse

- El LED indica los siguientes estados.

Verde	En funcionamiento / Carga completada
Verde intermitente	Encendiendo / Apagando
Naranja	Cargando
Rojo intermitente	Queda poca batería
Rojo intermitente cinco veces	Batería insuficiente para encender
Azul	Modo reposo

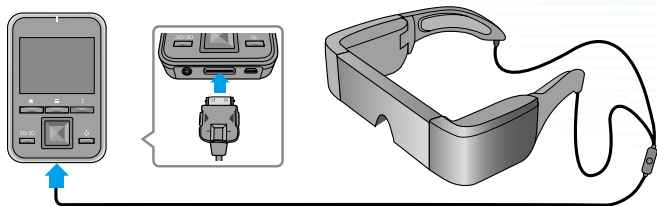
**1 Conecte las gafas-proyector y el mando.**

Inserte el cable de conexión de las gafas-proyector en el puerto de conexión para gafas-proyector del mando hasta que haga clic.

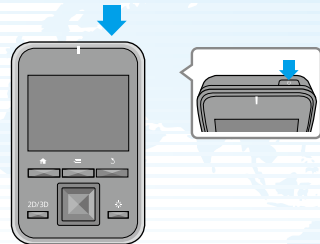
**2 Enciéndalo.**

Pulse el botón de encendido [⏻] situado en la parte superior del mando durante al menos dos segundos. El LED indicador se ilumina en verde indicando que el dispositivo está encendido.

## Apagar

1. Pulse el botón de encendido [⏻] durante al menos dos segundos. Aparecerá el menú [Opciones del dispositivo].
2. Seleccione [Apagar] - [Aceptar].

Si el botón de encendido [⏻] se pulsa durante menos de dos segundos, se activa o desactiva el Modo reposo.



Se consume algo de electricidad incluso cuando el dispositivo está apagado.

- 1 Póngase las gafas-proyector y ajústelas de forma que pueda ver toda la pantalla.**

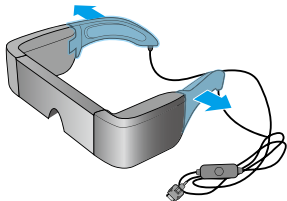

Utilice ambas manos para abrir las patillas y, a continuación, póngase las gafas-proyector.  
(El cable de conexión va por detrás de las orejas.)



No abra las patillas de las gafas-proyector con demasiada fuerza.



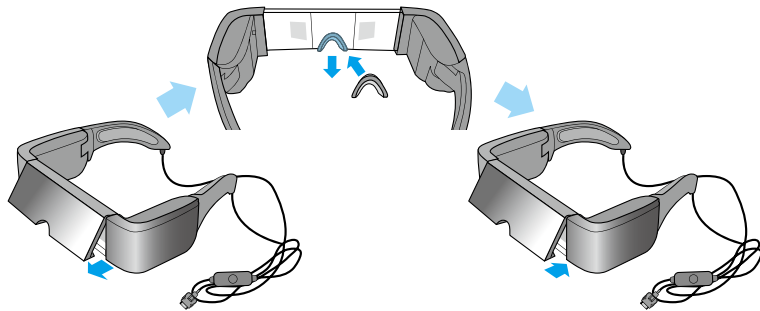

Si no puede ver la parte superior o inferior de la pantalla, retire la visera de lente y vuelva a colocar la almohadilla para la nariz.

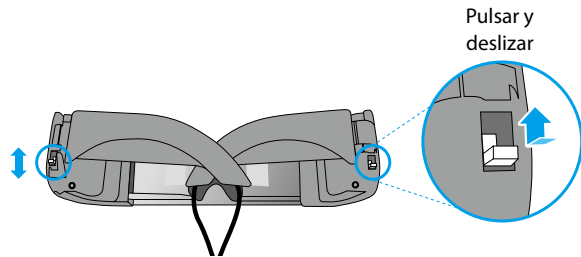

Tal como se indica en esta ilustración, utilice los interruptores para ensanchar las patillas de modo que se ajusten a su cabeza. (Los interruptores le permiten ajustar el ancho en tres niveles, con el ajuste más ancho en la parte superior y el más estrecho en la parte inferior.)

## Ponerse las gafas-proyector encima de unas gafas

1. Retire la almohadilla para la nariz de las gafas-proyector.
2. Acople los ganchos para gafas en la parte izquierda y derecha de las gafas-proyector.
3. Con las gafas puestas, baje las gafas-proyector desde la parte superior de la cabeza para colocárselas. Las gafas-proyector se apoyarán en la montura de las gafas con la ayuda de los ganchos.

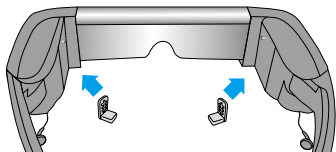

Si la altura de la pantalla no es correcta, pruebe a ajustar la posición de los ganchos.

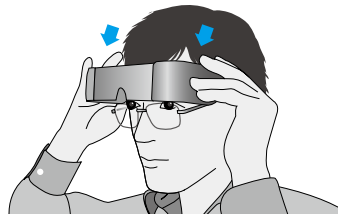
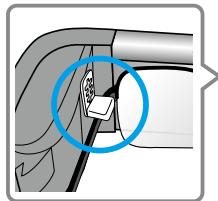

- Es posible que no pueda ponerse las gafas-proyector con determinados modelos de gafas, dependiendo de su forma.
- No es posible ponerse las gafas-proyector encima de gafas que tengan un ancho mayor de 147 mm.
- Cuando se ponga las gafas-proyector encima de unas gafas, puede utilizar el repuesto de almohadilla para la nariz en lugar de los ganchos para gafas.

## 2 Póngase los auriculares.

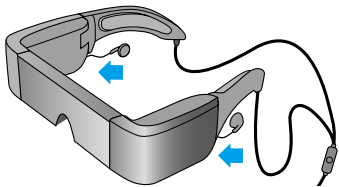

Conecte los auriculares suministrados en la parte izquierda y derecha de las gafas-proyector.

Si ya dispone de sus propios auriculares, conéctelos en el puerto para auriculares del mando y desconecte los auriculares incluidos con el producto.



Conecte únicamente auriculares en este puerto. No conecte ningún otro dispositivo.



- Retire los auriculares de los oídos cuando los conecte o los desconecte. Es posible que oiga algún ruido si desconecta los auriculares mientras está escuchando música o reproduciendo una película, pero ello no indica un funcionamiento incorrecto.
- No toque la sección de visualización de la pantalla mientras lleve puestas las gafas-proyector. Las huellas dactilares y otras marcas pueden provocar un deterioro de la calidad de imagen. Si la sección de visualización de imágenes se ensucia, límpiela suavemente con un limpiacristales disponible en el mercado.

## Visualizar la pantalla

Su percepción del tamaño de la pantalla varía en función de la ubicación de su punto de vista. Si su punto de vista está en la distancia, tendrá la sensación de que la pantalla está a lo lejos y es más grande.



Aprox. 2,5 m  
para 40 pulgadas

Aprox. 5 m  
para 80 pulgadas

## Entorno de visualización

El modo en que se percibe una imagen puede variar en función del brillo del entorno.



### Precaución

Resulta difícil ver todo el entorno mientras se está utilizando el producto. No deje objetos frágiles cerca de usted, ni se mueva de un lado a otro mientras lleve puestas las gafas-proyector.



- El modo en que se percibe una imagen varía en función del individuo.
- Si su visión es mejor en un ojo que en el otro, es posible que no pueda ver los contenidos 3D correctamente.

## ↶ Tecla ATRÁS

Muestra la pantalla anterior.

## ☰ Tecla MENÚ

- Muestra los menús disponibles para la pantalla actual.
- Muestra u oculta el teclado si se mantiene pulsada durante la introducción de texto.

## Ranura para tarjeta microSD

Permite insertar la tarjeta microSD.

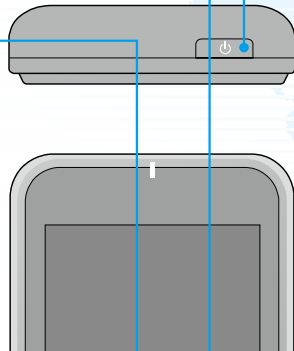
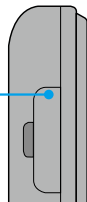

## ⏻ Botón de encendido

Púlselo durante al menos dos segundos para encender el dispositivo. Cuando el dispositivo está encendido:

- Si el botón se mantiene pulsado: el dispositivo se apaga; se activa/desactiva el Modo avión
- Si el botón se pulsa brevemente: se activa/desactiva el Modo reposo

## Tecla Volumen

Muestra la pantalla Volumen, que le permite ajustar el volumen.

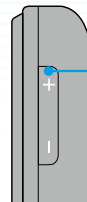

## Tecla INICIO

Una pulsación breve le lleva de vuelta a la pantalla de inicio. Mantenga esta tecla pulsada para mostrar las aplicaciones usadas recientemente.

## Tecla 2D/3D

Alterna entre el Modo 2D y 3D.

## Teclas de dirección

- Mueve el área de selección hacia arriba, abajo, izquierda o derecha.
- Desplaza la página.

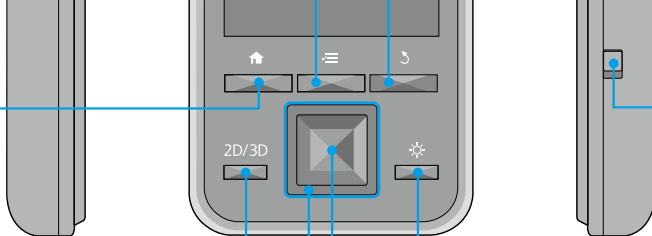

## Interruptor de bloqueo de teclas

Desplace el interruptor hacia abajo para evitar operaciones accidentales.

## Tecla Brillo

Muestra la pantalla Brillo, que le permite ajustar el brillo.

## Tecla Enter

Selecciona o confirma las opciones elegidas.

## Usar el trackpad



Trackpad

Al tocar el trackpad con el dedo, aparece un puntero en la pantalla.

Si toca el trackpad durante aproximadamente un segundo, el puntero aumenta de tamaño, lo que le permite arrastrar.

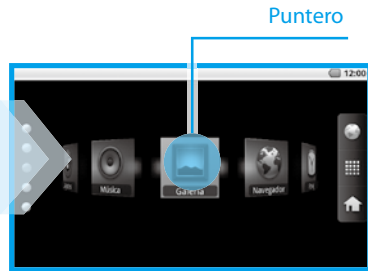

Puntero



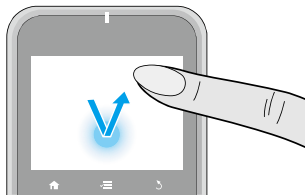

#### ■ Hacer clic

Mueva el puntero hasta un icono o elemento en pantalla y, a continuación, toque el trackpad.

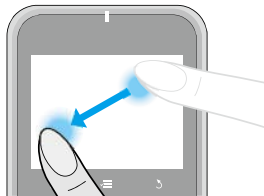

#### ■ Arrastrar

Toque el trackpad durante aproximadamente un segundo para seleccionar el icono o elemento en pantalla y, a continuación, arrastre el dedo por el trackpad para moverlo.

### Botón Silencio

Pulse el botón Silencio situado en el cable de conexión de las gafas-proyector para silenciar la imagen y el audio.

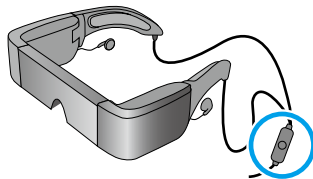

## Desbloquear



Arrastre el icono [  ] hacia arriba.

## Iconos de la pantalla de inicio

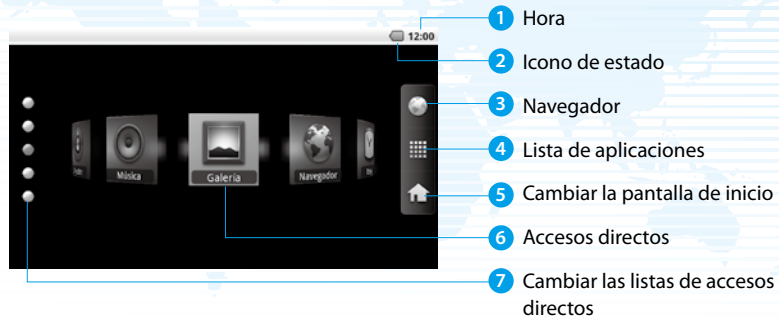





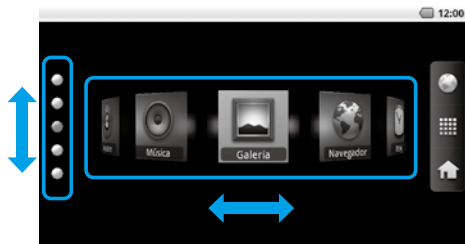







## Iniciar una aplicación desde un acceso directo

Utilice las teclas de dirección para seleccionar un acceso directo y, a continuación, pulse la tecla Enter.



## Iconos de la barra de estado

	Reproduciendo música		Dolby Mobile activado
	Comunicando mediante USB		Alarma programada
	Conectando/usando LAN inalámbrica		Modo avión
	Examinando tarjeta microSD		Desactivando tarjeta microSD
 [Baja] ↔  [Llena]	Estado de la batería		Cargando
	Descarga completada		

Puede acceder a Internet a través de una red LAN inalámbrica.

**1** Habilite la función LAN inalámbrica y, a continuación, busque redes disponibles.

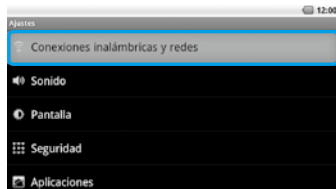

Inicie [🏠] desde la pantalla de inicio y, a continuación, seleccione [Conexiones inalámbricas y redes].

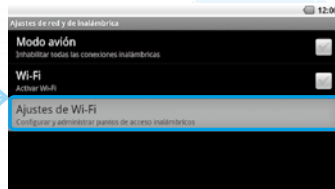

Seleccione [Ajustes de Wi-Fi].

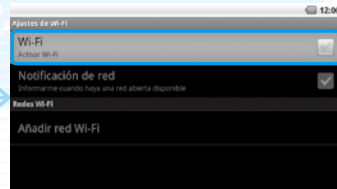

Seleccione [Wi-Fi].

## 2 Conéctese a una de las redes LAN inalámbricas que aparecen.

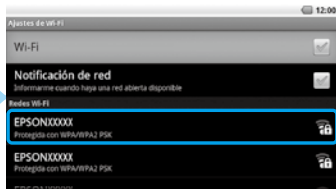

Seleccione la red a la que desea conectarse en [Redes Wi-Fi].



- Si selecciona una red con seguridad habilitada, deberá introducir una contraseña.
- Puede añadir una red manualmente si no encuentra la red a la que desea conectarse. Consulte el manual de usuario digital para obtener más información.

**1** Inserte la tarjeta microSD en el mando.

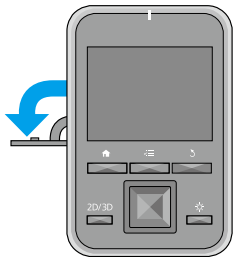

Abra la tapa en el sentido que indica la flecha.

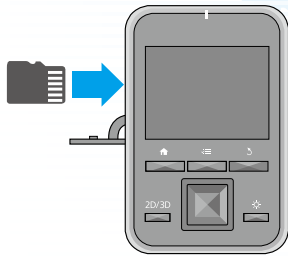

Deslice la tarjeta en la ranura hasta que encaje haciendo clic.

**Extraer la tarjeta microSD**

1. Inicie [Inicio] desde la pantalla de inicio y, a continuación, seleccione [Almacenamiento en el dispositivo y tarjeta SD] - [Desactivar tarjeta SD]. A continuación podrá extraer la tarjeta SD.
2. Abra la tapa, presione la tarjeta microSD una vez en el sentido que indica la flecha y, a continuación, extraiga la tarjeta.

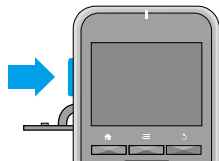

## 2 Copie los datos en la tarjeta microSD.

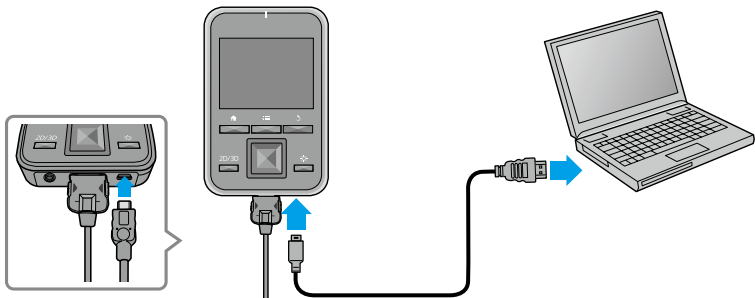

Conecte el mando al ordenador con el cable USB suministrado para copiar los datos.



No extraiga la tarjeta microSD ni apague el dispositivo mientras esté copiando datos o accediendo a un archivo. Si lo hace, los datos podrían dañarse.



- Puede almacenar hasta 4 GB de datos en la tarjeta microSDHC suministrada.
- Este producto admite tarjetas microSDHC de hasta 32 GB.
- La lectura de tarjetas microSDHC de gran capacidad puede tardar un tiempo.

### Manual de usuario digital

Este producto tiene preinstalado un manual de usuario digital. Cuando desee obtener información más detallada, inicie el manual de usuario digital desde la pantalla de inicio.



Utilice las teclas de dirección para seleccionar [ ? ] y, a continuación, pulse la tecla Enter.



■ Marcas comerciales



Fabricado con la licencia de Dolby Laboratories.

Dolby y el símbolo de la doble D son marcas comerciales de Dolby Laboratories.

iWnnIME © OMRON SOFTWARE Co., Ltd. 2011 All Rights Reserved.

Contains Adobe® Flash® Player by Adobe Systems Incorporated.

Adobe Flash Player Copyright © 1996-2011, Adobe Systems incorporated. Adobe, Flash and the Flash logo are either registered trademarks or trademarks of Adobe Systems Incorporated in the United States and/or other countries.



microSDHC Logo is a trademark of SD-3C, LLC.

Notas relativas a la función LAN inalámbrica

No utilice la función LAN inalámbrica en Francia a menos que se encuentre en interiores.

Si adquiere este producto fuera de Norteamérica, tenga en cuenta que emite ondas electromagnéticas de LAN inalámbrica en los canales 1 a 13. Por ello, la función LAN inalámbrica no debe utilizarse en Norteamérica, donde la Ley de Telegrafía Inalámbrica limita los canales de LAN inalámbrica a los números 1 a 11.

Respete las leyes y reglamentos locales al utilizar este producto en otras regiones.

Restricciones de Adobe Flash Player

- Está estrictamente prohibido copiar o distribuir el software.
- Está estrictamente prohibido modificar el software o crear trabajos derivados basados en el software.
- Está estrictamente prohibido realizar operaciones de ingeniería inversa, descompilación, desmontaje o cualquier otro intento de descubrir el código fuente del software.
- No podemos aceptar reclamaciones por responsabilidad debidas a daños indirectos, especiales, fortuitos, ejemplares, punitivos, consiguientes u otros daños que puedan derivar del uso de este software.

See-Through Mobile Viewer

# MOVERIO

BT-100

## **PT** Manual do Utilizador

Muito obrigado pela aquisição deste produto.



O seu gateway para uma experiência de entretenimento mais livre e mais confortável!

---

### **Antes da Utilização**

Certifique-se de que lê este manual com atenção de modo a utilizar o produto com segurança.

Depois de ler todas as instruções, guarde estas informações para uma consulta posterior.

Índice .....	54	Utilização do Dispositivo .....	61
 Instruções de Segurança		Dicas de Visualização .....	63
Notas sobre a Utilização.....	55	 Operações Básicas	
 Preparação		Utilização do Controlador .....	64
Verificação do Conteúdo da Embalagem .....	58	Utilização do Ecrã Início .....	66
Carregamento.....	59	Ligação à Internet .....	67
Ligar.....	60	Importação de Dados .....	68
		Marcas Comerciais e Assistência ao Cliente.....	69

## Instruções de Segurança

Os seguintes símbolos de aviso são utilizados neste manual para indicar possíveis operações ou manuseamento perigosos.

Certifique-se de que compreende estes avisos antes de proceder à leitura do manual.

### ■ Símbolos de segurança



#### Aviso

Este símbolo representa informações que, se ignoradas, podem resultar em ferimentos pessoais graves ou mesmo morte devido a manuseamento incorrecto.



#### Precaução

Este símbolo representa informações que, se ignoradas, podem resultar em ferimentos pessoais ou danos físicos devido a manuseamento incorrecto.

### ■ Símbolos de informações gerais



Indica operações que podem provocar danos ou ferimentos se não se tiver os cuidados devidos.



Indica informações adicionais e aspectos que podem ser úteis saber relativamente a um assunto.

### **Aviso** Risco de incêndio, choque eléctrico ou acidente

Utilize este produto apenas com a tensão indicada para a fonte de alimentação.

Utilize apenas o cabo USB e o transformador de CA fornecido.

Não utilize o transformador de CA fornecido com qualquer outro dispositivo.

Tenha os seguintes pontos em conta ao manusear o transformador de CA.

- Não ligue o transformador de CA a uma tomada a ser utilizada por muitos outros dispositivos.
- Não ligue o transformador de CA caso este apresente corpos estranhos presos, como pó.

- Ligue o transformador de CA de forma segura.
- Não segure no transformador de CA com as mãos molhadas.
- Não desligue o transformador de CA puxando pelo cabo.

Tenha os seguintes pontos em conta ao manusear o cabo de alimentação (o cabo microUSB fornecido).

- Não utilize se o cabo estiver danificado.
- Não modifique o cabo.
- Não coloque objectos pesados sobre o cabo.
- Não dobre, torça ou puxe o cabo de alimentação de forma excessiva.
- Não coloque o cabo na proximidade de um aquecedor eléctrico.

Não utilize o produto em localizações onde possa ficar molhado ou ser sujeito a humidade, como à chuva ou numa banheira ou chuveiro. Não

coloque recipientes com água, produtos químicos ou outros líquidos na proximidade deste produto.

---

Não coloque este produto em locais com fumo, vapor, humidade elevada ou pó, como bancadas de cozinha, ou na proximidade de humidificadores.

---

Não toque no transformador de CA durante uma trovoadas.

---

Não desmonte nem altere este produto (incluindo consumíveis).

---

Nas situações seguintes, desligue de imediato este produto, retire o transformador de CA e contacte um revendedor autorizado da Epson.

- Se vir fumo ou se reparar em odores ou ruídos estranhos.
- Se água ou partículas estranhas entrarem no produto.
- Se o produto cair ao chão ou se a mala ficar danificada.

---

 **Aviso**    **Risco de deformação devido a incêndio ou calor**

---

Não deixe este produto em locais sujeitos a temperaturas extremamente elevadas, como carros com as janelas fechadas, sob a luz directa do sol ou à frente de um aparelho de ar condicionado ou saídas de calor.

---

 **Aviso**    **Risco de incêndio ou queimaduras**

---

Não tape este produto nem o transformador de CA com um pano ou material semelhante durante a utilização.

---

 **Aviso**    **Risco de avaria ou choque eléctrico**

---

Não limpe este produto com um pano húmido ou solventes, tais como álcool, benzeno ou diluente.

 **Aviso**    **Risco de deficiência auditiva**

---

Não comece por utilizar este produto com o volume alto.

---



Pode ocorrer uma perda auditiva permanente se os auriculares forem utilizados com o volume alto por longos períodos de tempo.

---

 **Aviso**    **Risco de lesão ou envenenamento**

---

Não desmonte nem altere este produto.

---

Não utilize este produto enquanto conduz, cozinha ou realiza outras tarefas perigosas.

---

 **Aviso**    **Risco de interferência com outros dispositivos electrónicos**

---

Certifique-se de que não existe equipamento médico na zona antes de

utilizar dado que este produto pode causar interferência electromagnética no equipamento médico ou provocar uma avaria no equipamento.

---

Ao levar o produto para zonas onde é proibido o uso de ondas electromagnéticas, como em aviões ou em hospitais, desligue este produto ou desactive a função LAN sem fios.

---

Tenha os seguintes pontos em conta ao utilizar a rede LAN sem fios em instituições médicas.

- Não leve este produto para dentro de blocos operatórios, Unidades de Cuidados Intensivos (UCI) ou Unidades de Cuidados Cardíacos (ICC).
- Em enfermarias, desligue este produto ou pare as ondas electromagnéticas.
- Mesmo quando não se encontra em enfermarias, desligue este produto ou pare as ondas electromagnéticas no caso da presença de equipamento médico electrónico na zona.



- Siga todas as regras estipuladas pelas instituições médicas que proíbem a utilização de dispositivos que emitem ondas electromagnéticas ou que proíbem a entrada em determinadas zonas com tais dispositivos.

Se possuir um pacemaker ou um desfibrilhador implantado, certifique-se de que mantém uma distância de pelo menos 22 cm entre este produto e o dispositivo implantado quando utilizar a rede LAN sem fios. Antes de utilizar, certifique-se de que não existe ninguém com um pacemaker perto de si e, caso se encontre num local com muita gente, como um comboio, desligue este produto ou pare as ondas electromagnéticas.

Não utilize este produto na proximidade de dispositivos de controlo automático, como portas automáticas ou alarmes de incêndio, dado que pode causar interferências electromagnéticas que podem provocar um acidente ou uma avaria nos dispositivos.

Em locais com utilização restrita, como aeronaves ou hospitais, siga as

regras do local (como anúncios nos aviões).

### **Precaução** Risco de incêndio, choque eléctrico ou acidente

Por questões de segurança, quando acabar de utilizar este produto, certifique-se de que o desliga.

Ao proceder a operações de manutenção, certifique-se de que desliga o transformador de CA bem como todos os cabos.

### **Precaução** Risco de queimaduras

Não toque nas secções quentes do transformador de CA durante algum tempo após a sua utilização.

Não utilize este produto por longos períodos de tempo caso o controlador esteja a tocar em alguma parte da sua pele.

 **Precaução**    Risco de lesão visual

---

Quando utilizar este produto, não olhe directamente para o sol ou para quaisquer luzes brilhantes.

 **Precaução**    Risco de danos ou avarias

---

Não coloque este produto em locais sujeitos a vibrações ou impactos.

Não utilize nem armazene este produto em locais sujeitos a temperaturas altas ou baixas. Do mesmo modo, evite locais sujeitos a alterações súbitas da temperatura.

Não coloque este produto na proximidade de linhas de alta tensão ou objectos magnetizados.

 **Precaução**    Risco de deterioração da qualidade da imagem

---

Não utilize nem armazene este produto em locais sujeitos a fumo.

 **Precaução**    Risco de lesões ou indisposição

---

Não deixe cair este produto nem o trate com força desnecessária.

Quando utilizar este produto, tenha cuidado com as extremidades da armação.

Não coloque o dedo entre as peças em movimento deste produto, como as dobradiças.

Certifique-se de que utiliza correctamente este produto.

Não transporte este produto pelo cabo.

---

Este produto só deve ser utilizado para visualização de imagens.

---

No caso da ocorrência de um problema ou avaria, deixe de utilizar imediatamente este produto.

---

Deixe de utilizar este produto se a sua pele parecer diferente quando usa este produto.

---

Faça sempre pausas periódicas quando visualizar imagens com este produto.

---

Caso se sinta cansado ou desconfortável ao visualizar com este produto, pare de imediato a visualização.

---

Não coloque quaisquer objectos quebradiços ou frágeis no ambiente circundante quando utilizar este produto.

---

Utilize apenas este produto quando visualizar imagens. Não se mova

enquanto utiliza este produto.

---

Não utilize este produto se for sensível à luz ou se se sentir doente ou indisposto.

---

As crianças (sobretudo em idade pré-escolar) não devem utilizar este produto dado que a sua visão ainda se está a desenvolver.



### **Precaução**    **Risco de lesão ou envenenamento**

---

Contacte um revendedor autorizado da Epson quando substituir as baterias.

---

Elimine este produto de acordo com as leis e regulamentos locais.

Verifique se estão incluídos todos os itens.

Dispositivo (incluindo protecção da lente e almofada do nariz)

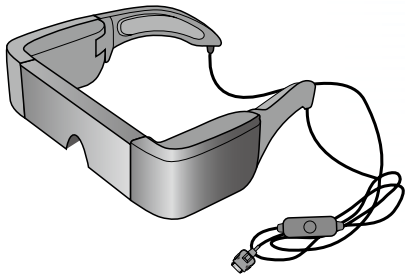

Controlador



Cabo USB (1,4 m)

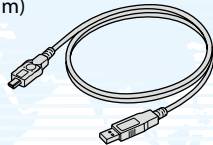

Transformador de CA

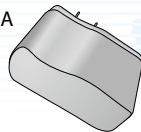

Cartão microSDHC (amostra)



Ganchos para óculos

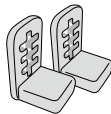

Mala de transporte

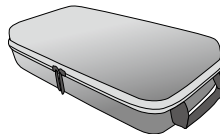

Auriculares (E e D)

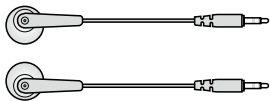

Almofada de substituição do nariz (x2)

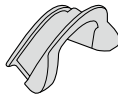

Manual do Utilizador (este manual)

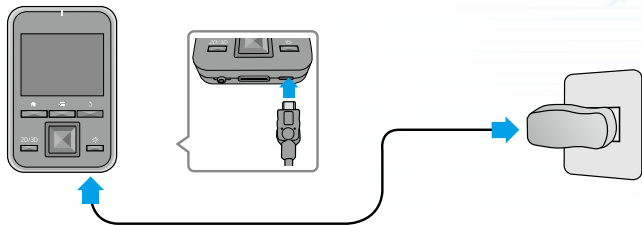

**1** Ligue o controlador e o transformador de CA.

Ligue o controlador e o transformador de CA com o cabo USB.

Ligue o transformador de CA.

**Carga padrão**



- O carregamento inicial demora cerca de 5 horas.
- O indicador LED passa para laranja durante o carregamento.
- O indicador LED passa para verde quando o carregamento chega ao fim.

## 2 Quando o carregamento chega ao fim, retire o transformador de CA.



- A bateria não está totalmente carregada no momento da compra. Carregue a bateria antes de utilizar este produto.
- A bateria tem uma duração útil aproximada de 6 horas. A duração útil da bateria depende das condições de utilização e do ambiente de funcionamento.

- A quantidade de carga restante da bateria é apresentada na parte de cima do ecrã Início.

	A carga da bateria está cheia
	A carga da bateria está fraca
	A bateria tem de ser carregada

- O LED indica o seguinte estado.

Verde	Em funcionamento / Carregamento terminado
Verde intermitente	A ligar/a desligar
Laranja	Carregamento
Vermelho intermitente	A carga da bateria está fraca
Vermelho intermitente cinco vezes	Carga da bateria insuficiente para ligar
Azul	Modo standby

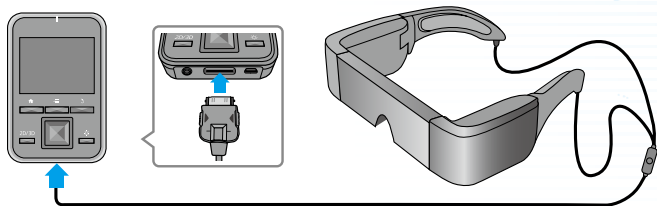
**1** Ligue o dispositivo e o controlador.

Insira o cabo de ligação do dispositivo na porta de ligação do dispositivo do controlador até encaixar.

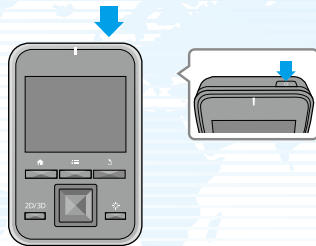
**2** Ligue.

Prima o botão ligar/desligar [⏻] na parte de cima do controlador durante pelo menos dois segundos. O indicador LED passa a verde para indicar que o dispositivo foi ligado.



## Desligar

1. Prima o botão ligar/desligar [⏻] durante pelo menos dois segundos. É apresentado o menu [Opções do dispositivo].
2. Seleccione [Desligar] - [OK].

.....  
Premir o botão ligar/desligar [⏻] durante menos de dois segundos activa ou desactiva o modo de standby.



É consumida alguma quantidade de electricidade mesmo quando o dispositivo está desligado.

- 1** Coloque o dispositivo e faça ajustes para que consiga ver o ecrã inteiro.

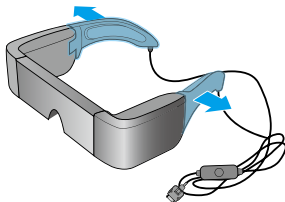

Use as duas mãos para abrir as hastes e, de seguida, coloque o dispositivo.  
(O cabo de ligação fica por detrás dos ouvidos.)



Não utilize demasiada força para abrir as hastes do dispositivo.

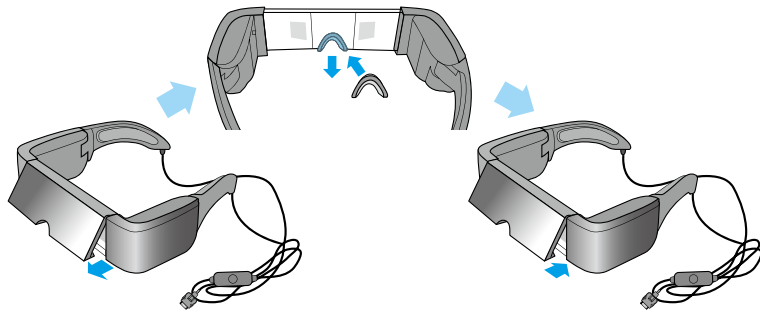

Caso não consiga visualizar a parte de cima ou a parte de baixo do ecrã, retire a protecção da lente e substitua a almofada do nariz.

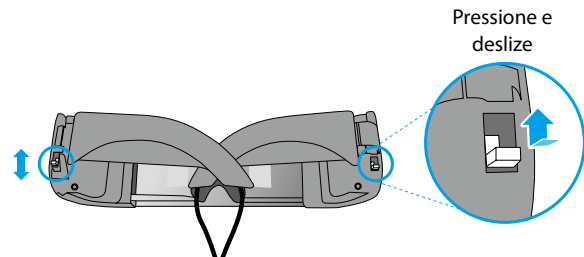

Conforme demonstrado na ilustração acima, utilize os interruptores para alargar as hastes para se ajustarem à cabeça. (Os interruptores permitem-lhe ajustar a largura em três etapas com o ajuste mais largo na parte de cima e o ajuste mais estreito na parte de baixo.)

## Utilização do dispositivo por cima dos óculos

1. Retire a protecção do nariz do dispositivo.
2. Fixe os ganchos dos óculos à esquerda e à direita do dispositivo.
3. Com os óculos colocados, baixe o dispositivo a partir da parte de cima da cabeça para colocá-lo. O dispositivo é suportado pelos ganchos dos óculos sobre a armação dos óculos.

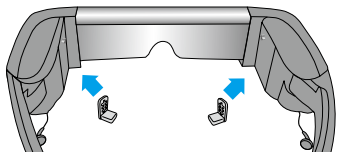

Se a altura do ecrã não estiver correcta, tente ajustar a posição dos ganchos dos óculos.

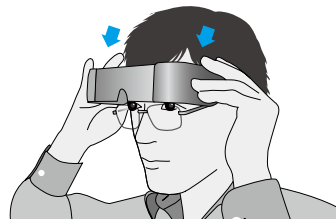
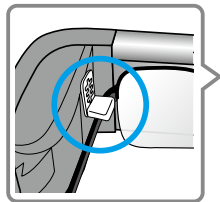

- Dependendo do formato dos seus óculos, pode não conseguir utilizar o dispositivo.
- Não pode utilizar o dispositivo por cima de óculos com mais de 147 mm de amplitude.
- Pode utilizar a almofada de substituição do nariz em vez dos ganchos dos óculos quando utilizar o dispositivo por cima dos óculos.

## 2 Coloque os auriculares.

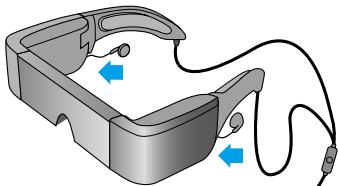

Ligue os auriculares fornecidos à esquerda e direita do dispositivo.

Se tiver os seus próprios auriculares, ligue-os à porta do dispositivo do controlador e desligue os auriculares fornecidos com o produto.



Os auriculares só podem ser ligados a esta porta. Não ligue quaisquer outros dispositivos.



- Retire os auriculares dos ouvidos quando ligar ou desligar os auriculares. Se desligar os auriculares enquanto estiver a ouvir música ou a ver um filme, é possível que ouça algum ruído. Contudo, não se trata de uma avaria.
- Enquanto utilizar o dispositivo, não toque na secção de visualização do ecrã. As dedadas e afins podem causar uma deterioração da qualidade da imagem. Caso a secção de visualização do ecrã fique suja, limpe-a cuidadosamente com um produto de limpeza de vidro à venda no mercado.

## Visualização do Ecrã

A sua visão do tamanho do ecrã muda em função da localização do seu ponto de vista. Se o seu ponto de vista estiver distante, vai ter a sensação de que o tamanho do ecrã está distante e é maior.



Cerca de 2,5 m  
para 40 polegadas

Cerca de 5 m  
para 80 polegadas

## Ambiente de Visualização

O modo como uma imagem é apreendida pode depender do brilho do ambiente circundante.



### Precaução

É difícil ver todo o ambiente circundante durante a visualização com o produto. Não deixe artigos frágeis no ambiente circundante imediato e não caminhe enquanto utiliza o dispositivo.



- O modo como uma imagem é apreendida varia de indivíduo para indivíduo.
- Caso exista uma diferença entre a capacidade da sua visão nos olhos esquerdo e direito, é possível que não consiga visualizar correctamente conteúdos 3D.

### Tecla VOLTAR

Apresenta o ecrã prévio.

### Tecla MENU

- Apresenta os menus disponíveis para o ecrã actual.
- Mostra ou oculta o teclado se for mantido premido durante a introdução de texto.

### Ranhura para cartão microSD

Insira o cartão microSD.

### Botão Ligar/Desligar

Prima durante pelo menos dois segundos para ligar. Quando ligado:

- Manter premido: desliga; liga/desliga Modo de voo
- Pressão curta: liga/desliga Modo repouso

### Tecla Volume

Apresenta o ecrã do volume que lhe permite ajustar o volume.

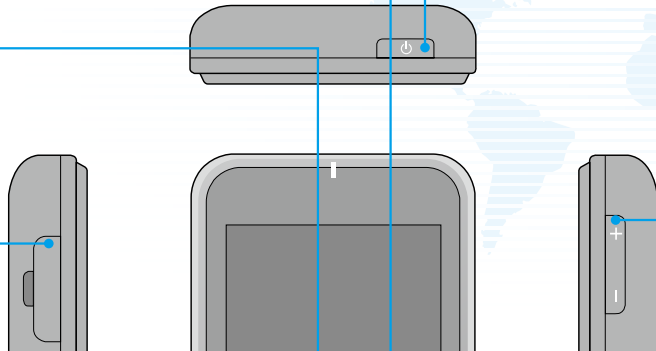



## Tecla INÍCIO

Uma pressão breve permite-lhe voltar ao ecrã Início. Mantenha premido para visualizar as aplicações recentemente utilizadas.

## Tecla 2D/3D

Alterna entre o modo 2D e 3D.

## Teclas de direcção

- Move a área seleccionada para cima, baixo, esquerda ou direita.
- Percorre a página.

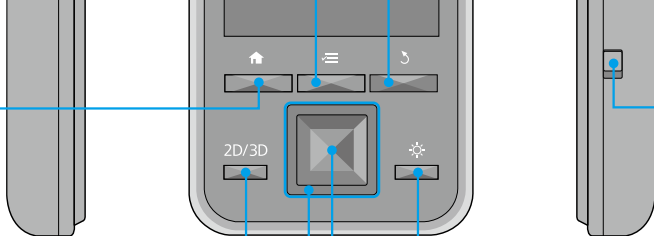

## Interruptor de bloqueio das teclas

Mova o interruptor para baixo para impedir operações acidentais.

## Tecla Brilho

Apresenta o ecrã do brilho que lhe permite ajustar o brilho.

## Tecla Enter

Faz selecções ou confirma as suas escolhas.

## Utilização do trackpad



Trackpad

Ao tocar no trackpad com o dedo,  
é apresentado um ponteiro no ecrã.

Tocar no trackpad durante cerca de um  
segundo aumenta o ponteiro, permitindo-  
lhe arrastar.

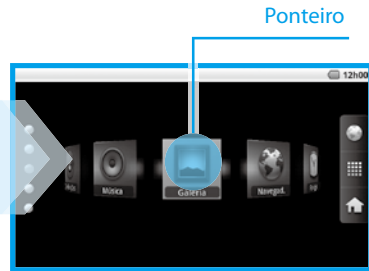

Ponteiro

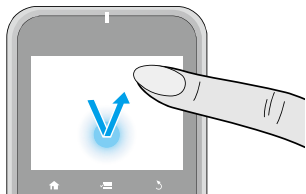

#### ■ Clicar

Mova o ponteiro para um ícone ou item do visor e, de seguida, toque no trackpad.

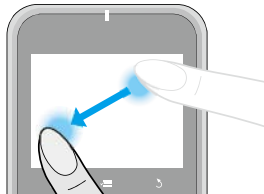

#### ■ Arrastar

Toque no trackpad durante cerca de um segundo para seleccionar o ícone ou item do visor e, de seguida, arraste o dedo sobre o trackpad para movê-lo.

### Botão Surdina

Prima o botão Surdina no cabo de ligação do dispositivo para silenciar a imagem e o áudio.

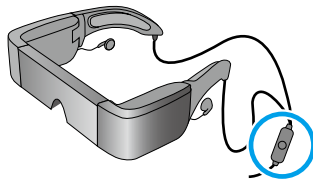

## Desbloqueio

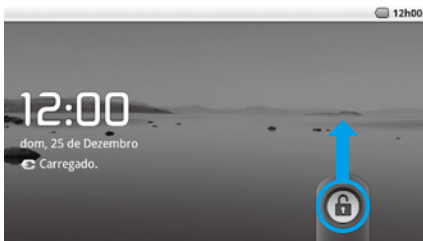

Arrastar o [  ] para cima.

## Ícones do ecrã Início

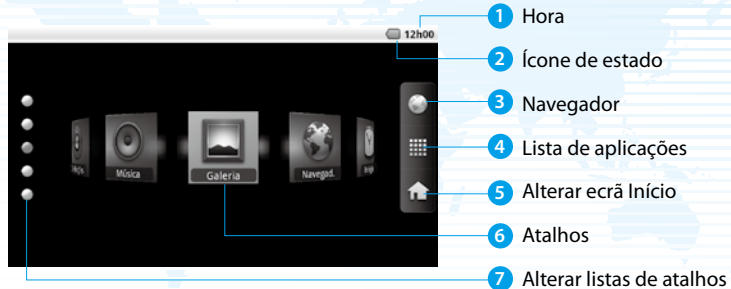

## Lançamento de uma aplicação a partir de um atalho

Utilize as Teclas de direcção para seleccionar um atalho e prima a tecla Enter.



## Ícones da barra de estado

	Reprodução de música		Dolby Mobile ligado
	Comunicação via USB		Definição do alarme
	Ligação/utilização da LAN sem fios		Modo de voo
	Leitura do cartão microSD		Desmontagem do cartão microSD
	[Fraca] ↔ [Completa]		Carregamento
	Transferência completa		

Pode aceder à Internet através de uma rede LAN sem fios.

**1** Active a rede LAN sem fios e, de seguida, procure redes disponíveis.

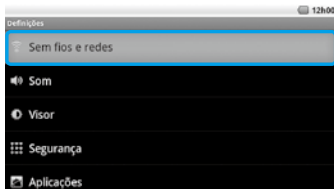

Inicie [🏠] a partir do ecrã Início e, de seguida, seleccione [Sem fios e redes].

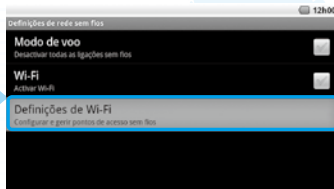

Selecione [Definições de Wi-Fi].



Selecione [Wi-Fi].

**2** Ligue a uma das redes LAN sem fios apresentadas.

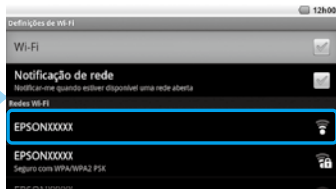

Selecione a rede à qual se deseja ligar a partir de [Redes Wi-Fi].



- Se seleccionar uma rede com segurança activada, deve introduzir uma palavra-passe.
- Pode adicionar manualmente uma rede caso a rede a que deseja ligar não for encontrada. Para obter pormenores adicionais, consulte o manual do utilizador digital.

**1** Insira o cartão microSD no controlador.

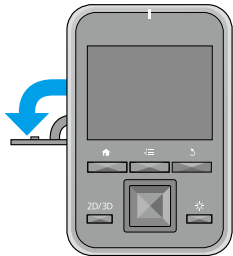

Abra a tampa na direcção indicada pela seta.

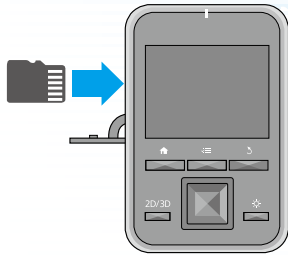

Insira o cartão na ranhura até encaixar.

**Remoção do cartão microSD**

1. Inicie [🔘] a partir do ecrã Início e, de seguida, seleccione [Armazenamento do dispositivo e cartão SD] - [Desmontar cartão SD]. O cartão SD pode, agora, ser retirado.
2. Abra a tampa, pressione o cartão microSD uma vez na direcção indicada pela seta e, de seguida, retire o cartão.

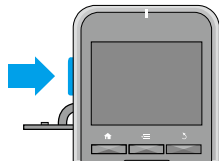



## 2 Copie dados para o cartão microSD.

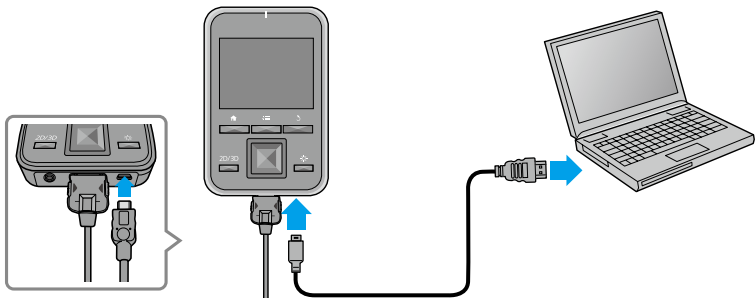

Ligue o controlador ao seu computador com o cabo USB fornecido para copiar os dados.



Não retire o cartão microSD nem desligue o aparelho enquanto estiver a copiar dados ou a aceder a um ficheiro. Caso contrário, os dados poderão ficar corrompidos.



- Pode armazenar até 4 GB de dados no cartão microSDHC fornecido.
- Este produto suporta cartões microSDHC até 32 GB.
- Pode ser necessário algum tempo para ler cartões microSDHC grandes.

## Manual do Utilizador Digital

Um Manual do Utilizador Digital vem pré-instalado neste produto. Quando desejar obter informações mais pormenorizadas, inicie o Manual do Utilizador Digital a partir do ecrã Início.



Utilize as Teclas de direcção para seleccionar [ ? ] e, de seguida, prima a tecla Enter.

■ Marcas Comerciais



Fabricado sob licença da Dolby Laboratories.

Dolby e o símbolo duplo D são marcas registradas da Dolby Laboratories.

iWnnIME © OMRON SOFTWARE Co., Ltd. 2011 All Rights Reserved.

Contains Adobe® Flash® Player by Adobe Systems Incorporated.

Adobe Flash Player Copyright © 1996-2011, Adobe Systems incorporated. Adobe, Flash and the Flash logo are either registered trademarks or trademarks of Adobe Systems Incorporated in the United States and/or other countries.



microSDHC Logo is a trademark of SD-3C, LLC.

**Notas Relativas à Rede LAN Sem Fios** Em França, não utilize a função LAN Sem Fios, excepto no caso de se encontrar no interior.

Se adquiriu este produto fora da América do Norte, tenha em conta que este produto emite ondas electromagnéticas da rede LAN sem fios nos canais 1 a 13. Por conseguinte, não utilize a função LAN sem fios na América do Norte, em que os canais LAN sem fios estão limitados de 1 a 11 com base na Lei relativa a Telecomunicações Sem Fios.

Respeite as leis e regulamentos locais aquando da utilização noutras regiões.

**Restrições do Adobe Flash Player**

- É totalmente proibida a cópia ou distribuição do software.
- É totalmente proibida a modificação ou criação de trabalhos derivados baseados no software.
- É totalmente proibida a engenharia invertida, descompilação, desmontagem ou qualquer tipo de tentativa para descobrir o código de origem do software.
- Não nos responsabilizamos por queixas decorrentes de danos indirectos, especiais, acidentais, exemplares, punitivos, consequenciais ou outros que possam resultar da utilização deste software.



Copyright©2011 Seiko Epson Corporation. All rights reserved. Printed in China XX.XX.-XX(XXX)



\*412182600\*