

# CONVECTION MICROWAVE DRAWER

MODEL: SMD2499FS



REGISTER YOUR PRODUCT .....	2	MICROWAVE OVEN COOKING .....	17
CONSUMER LIMITED WARRANTY .....	3	CONVECTION COOKING - PRESETS .....	23
PRECAUTIONS TO AVOID POSSIBLE EXPOSURE TO EXCESSIVE MICROWAVE ENERGY .....	4	CONVECTION COOKING - MANUAL .....	27
IMPORTANT SAFETY INSTRUCTIONS .....	5	SPEED COOK – MICROWAVE & CONVECTION COMBINATION .....	31
INFORMATION YOU NEED TO KNOW .....	8	OTHER FEATURES .....	32
PART NAMES .....	12	CLEANING AND CARE .....	35
BEFORE OPERATING .....	15	BEFORE YOU CALL FOR SERVICE .....	36
CONNECTING YOUR APPLIANCE .....	16	AUTO-TOUCH GUIDE .....	37

# REGISTER YOUR PRODUCT

Registering your new product is easy and offers benefits that help you get the most out of your Sharp product including:

- ✓ **Convenience:** If you ever need warranty support, your product information is already on file.
- ✓ **Communication:** Stay up to date with important notifications and special offers from SHARP.
- ✓ **Support:** Quickly access support content including Owner's Manuals, FAQ's, How-to Videos, and much more.

## 3 EASY WAYS TO REGISTER TODAY!

 <p><b>SCAN</b> Use the camera or QR code scanning application on your mobile device</p> <p>Scan this QR Code on your mobile device</p>	 <p><b>ONLINE</b> Visit our sites to learn more about your product at <a href="http://sharpusa.com">sharpusa.com</a> and <a href="http://sbl.sharpusa.com">sbl.sharpusa.com</a></p> <p>Visit <a href="http://www.sharpusa.com/register">http://www.sharpusa.com/register</a></p>	 <p><b>CALL US</b> <b>US</b>     <b>800-BE-SHARP</b>               800-237-4277 Mon-Fri: 7am-7pm CST Sat-Sun: 9am-7pm CST</p> <p>Contact a Sharp Advisor on the phone</p>
--	---	--

# PRODUCT SUPPORT



If you have questions about the setup or operation of your product, please refer to the corresponding section within this manual.

Additionally, visit [www.sharpusa.com/support](http://www.sharpusa.com/support) to access exclusive content about your product including:

- FAQ's and How-To Videos
- Find or Request Service
- Purchase an Extended Warranty
- Downloads including the Installation Guide, Spec Sheet, and Owner's Manual

# CONTACT US

If at any time you have questions or comments concerning your SHARP product, please contact the SHARP Customer Assistance Center. We are available to assist you through multiple contact methods for your convenience:

 <p><b>EMAIL</b> Available 24/7 US: <a href="http://sharpusa.com">sharpusa.com</a></p> <p>See the Contact Us section on our sites</p>	 <p><b>CHAT ONLINE</b> Mon-Fri: 7am-7pm CST Sat-Sun: 9am-7pm CST</p> <p>U.S.   <a href="http://www.sharpusa.com/support">www.sharpusa.com/support</a></p>	 <p><b>CALL US</b> <b>US</b>     <b>800-BE-SHARP</b>               800-237-4277 Mon-Fri: 7am-7pm CST Sat-Sun: 9am-7pm CST</p> <p>Contact a Sharp Advisor on the phone</p>
--	--	--

# SHARP®

## CONSUMER LIMITED WARRANTY

SHARP ELECTRONICS CORPORATION ("Sharp") warrants to the first consumer purchaser that this Sharp brand product (the "Product"), when shipped in its original container, will be free from defective workmanship and materials, and agrees that it will, at its option, either repair the defect or replace the defective Product or part thereof with a new or remanufactured equivalent at no charge to the purchaser for parts or labor for the period(s) set forth below.

This warranty does not apply to any cosmetic or appearance items of the Product nor to the additional excluded item(s) set forth below nor to any Product the exterior of which has been damaged or defaced, which has been subjected to misuse, abnormal service, or handling, or which has been altered or modified in design or construction. In order to enforce the rights under this limited warranty, the purchaser should follow the steps set forth below and provide proof of purchase to the servicer.

The limited warranty described herein is in addition to whatever implied warranties may be granted to purchasers by law. ALL IMPLIED WARRANTIES INCLUDING THE WARRANTIES OF MERCHANTABILITY AND FITNESS FOR USE ARE LIMITED TO THE PERIOD(S) FROM THE DATE OF PURCHASE SET FORTH BELOW. Some states do not allow limitations on how long an implied warranty lasts, so the above limitation may not apply to you.

Neither the sales personnel of the seller nor any other person is authorized to make any warranties other than those described herein, or to extend the duration of any warranties beyond the time period described above on behalf of Sharp. The warranties described herein should be the sole and exclusive warranties granted by Sharp and should be the sole and exclusive remedy available to the purchaser. Correction of defects, in the manner and for the period of time described herein, should constitute complete fulfillment of all liabilities and responsibilities of Sharp to the purchaser with respect to the Product, and should constitute full satisfaction of all claims, whether based on contract, negligence, strict liability or otherwise. In no event should Sharp be liable, or in any way responsible, for any damages or defects in the Product which were caused by repairs or attempted repairs performed by anyone other than a Sharp authorized servicer. Nor should Sharp be liable or in any way responsible for any incidental or consequential economic or property damage. Some states do not allow the exclusion of incidental or consequential damages, so the above exclusion may not apply to you.

THIS LIMITED WARRANTY IS VALID ONLY IN THE FIFTY (50) UNITED STATES, THE DISTRICT OF COLUMBIA AND PUERTO RICO.

**Product model number & description:**

SMD2499FS, Home Use Convection Microwave Drawer™ Oven (Be sure to have this information available when you need service for your product.)

**Warranty period for this product:**

One (1) year parts and labor, including in-home service. Product must be accessible to provide service. The warranty period continues for an additional four (4) years, for a total of five (5) years, with respect to the magnetron tube in the Product for parts only; labor and service are not provided free of charge for this additional period.

**Additional item(s) excluded from warranty coverage:**

Commercial, non-residential, or use inconsistent with published installation and product operational instructions.  
Non-functional accessories, light bulb, service calls to your home to instruct how to use your Convection Microwave Drawer appliance, replace or repair house fuses or to correct house wiring, improper commercial use, installation, or maintenance, damage to the product caused by delivery, accident, modifications, fire, floods or acts of God.

**What to do to obtain service:**

In-home service is provided for one (1) year from date of purchase. Service can be arranged by calling 1-800-BE-SHARP. Be sure to have Proof of Purchase, Model, and Serial Number available.

TO OBTAIN SUPPLY, ACCESSORY OR PRODUCT INFORMATION, CALL 1-800-BE-SHARP or visit [www.sharppusa.com](http://www.sharppusa.com). SAVE THE PROOF OF PURCHASE AS IT IS NEEDED SHOULD YOUR OVEN EVER REQUIRE WARRANTY SERVICE.

## **PRECAUTIONS TO AVOID POSSIBLE EXPOSURE TO EXCESSIVE MICROWAVE ENERGY**

- (a)** Do not attempt to operate this oven with the door open since open-door operation can result in harmful exposure to microwave energy. It is important not to defeat or tamper with the safety interlocks.
- (b)** Do not place any object between the oven front face and the door or allow soil or cleaner residue to accumulate on sealing surfaces.
- (c)** Do not operate the oven if it is damaged. It is particularly important that the oven door close properly and that there is no damage to the: (1) door (bent), (2) hinges and latches (broken or loosened), (3) door seals and sealing surfaces.
- (d)** The oven should not be adjusted or repaired by anyone except properly qualified service personnel.

# IMPORTANT SAFETY INSTRUCTIONS

## CAUTION FOR WIRELESS LAN

### CAUTION FOR USAGE ABOUT WI-FI

- If you are using in the following areas, the operation cannot be guaranteed: near Bluetooth® wireless communications devices using the same frequency (2.4 GHz) as this product or specified low power wireless devices. There may also be issues in locations with devices, such as microwave ovens, that emit a magnetic field; as well as in areas with static electricity or radio disturbance, all of which can interfere with the Wi-Fi signal.
- Wireless connection and performance cannot be guaranteed for all routers or housing environments. In the following places, it is possible the Wi-Fi cannot reach or is disconnected: inside of a building made with concrete, reinforced metal, near an obstruction (e.g., a wall) or near a wireless communications device using the same frequency.
- Wireless LAN of this product corresponds to channels 1-13. It is not available to communicate with routers set up to other channels.

### CAUTION FOR PERSONAL INFORMATION (RELATED TO SECURITY)

- Using a wireless LAN device has the possibility of interception when using Wi-Fi, regardless of password setting.
- Depending on the location where you are connecting your oven, ensure you have the right/authority to connect the appliance to the available Wi-Fi network.
- If disposing of unit, giving or selling to a third party, be sure to Reset Wi-Fi Settings as described in this manual. The wireless LAN function of the unit should be initialized (reset) in case of handover to a third party to avoid illegal access from unauthorized parties.

### MINIMUM REQUIREMENTS FOR WI-FI/ROUTER SPECIFICATIONS:

- IEEE 802.11 b/g/n compatible WLAN
- 72.2Mbps receive and transmit PHY rate using 20MHz bandwidth
- 150Mbps receive and transmit PHY rate using 40MHz bandwidth
- 802.11i (WPA, WPA2). Open, shared key, and pair-wise key authentication services
- Wi-Fi WPS support
- WPA2-AES is the recommended encryption method

## IMPORTANT REGULATORY INFORMATION

**CAUTION** Any changes or modifications to the appliance not expressly approved by the party responsible for compliance could void the user's authority to operate the appliance.

**Note:** This equipment has been tested and found to comply with the limits for a Class B digital device, pursuant to Part 15 of the FCC Rules. These limits are designed to provide reasonable protection against harmful interference in a residential installation. This equipment generates, uses and can radiate radio frequency energy and, if not installed and used in accordance with the instructions, may cause harmful interference to radio communications. However, there is no guarantee that interference will not occur in a particular installation. If this equipment does cause harmful interference to radio or television reception, which can be determined by turning the equipment off and on, the user is encouraged to try to correct the interference by one or more of the following measures:

- Reorient or relocate the receiving antenna.
- Increase the separation between the equipment and receiver.
- Connect the equipment to an outlet on a circuit different from that to which the receiver is connected.
- Consult the dealer or an experienced radio/TV technician for help.

### SHARP HOME USE CONVECTION MICROWAVE DRAWER MODEL# SMD2499FS

This device complies with Part 15 of the FCC Rules. Operation is subject to the following two conditions: (1) This device may not cause harmful interference, and (2) this device must accept any interference received, including interference that may cause undesired operation.

- Contains FCC: RX3-B01
- Contains IC: 2878F-B01

Responsible Party:

Sharp Electronics Corporation

100 Paragon Drive, Montvale, NJ 07645

TEL: 1-800-BE-SHARP

[www.sharppusa.com](http://www.sharppusa.com)

# IMPORTANT SAFETY INSTRUCTIONS

## READ ALL INSTRUCTIONS BEFORE USING

When using the appliance, basic safety precautions should be followed, including the following:

**WARNING** *To reduce the risk of burns, electric shock, fire, injury to persons or exposure to excessive microwave energy:*

- 1 Read all instructions before using the appliance.
- 2 Read and follow the specific “PRECAUTIONS TO AVOID POSSIBLE EXPOSURE TO EXCESSIVE MICROWAVE ENERGY” on page 4.
- 3 This appliance must be properly grounded. See page 8 for GROUNDING INSTRUCTIONS.
- 4 Install or locate this appliance only in accordance with the provided Installation Manual.
- 5 Some products such as whole eggs in shell and sealed containers (for example, closed glass jars) are able to rupture and should not be heated in the appliance.
- 6 Use this appliance only for its intended use as described in this manual. Do not use corrosive chemicals or vapors in this appliance. This appliance is specifically designed to heat, cook or dry food. It is not designed for use in industrial, laboratory or marine environments.
- 7 **HOT CONTENTS CAN CAUSE SEVERE BURNS. DO NOT ALLOW CHILDREN TO USE THE MICROWAVE OVEN.** Use caution when removing hot items.
- 8 Do not operate this appliance if it has a damaged cord or plug, if it is not working properly or if it has been damaged or dropped.
- 9 This appliance should be serviced only by qualified service personnel. Contact nearest Sharp Authorized Servicer for examination, repair or adjustment.
- 10 Do not cover or block any openings on the appliance.
- 11 Do not store or use this appliance outdoors. Do not use this product near water, such as near a kitchen sink, in a wet basement, near a swimming pool or similar locations.
- 12 Do not immerse cord or plug in water.
- 13 Keep cord away from heated surfaces.
- 14 Do not climb or sit on the appliance.
- 15 Be sure that fingers or other objects or materials are not around the appliance opening when the appliance is closed.
- 16 Do not let cord hang over edge of table or counter.
- 17 Do not put fingers or clothes around the drawer guides when the appliance is opened or closed. They could be caught in the guides when the appliance is closed.
- 18 Be sure that the food and container are shorter than the drawer before closing it. You can refer to the height of the side walls of the drawer.
- 19 When cleaning appliance sealing surfaces that come together on closing the drawer, use only mild, nonabrasive soaps or detergents applied with a sponge or soft cloth. See cleaning instructions on page 35.
- 20 To reduce the risk of fire in the appliance cavity:
  - a Do not overcook food. Carefully attend appliance when paper, plastic or other combustible materials are placed inside the appliance to facilitate cooking.
  - b Remove wire twist-ties from paper or plastic bags before placing bag in appliance.
  - c If materials inside the appliance ignite, keep appliance door closed, turn microwave off and shut off power at the fuse or circuit breaker panel.
  - d Do not use the appliance for storage purposes. Do not leave paper products, cooking utensils, or food in the appliance when not in use.
- 21 Liquids, such as water, coffee or tea are able to be overheated beyond the boiling point without appearing to be boiling due to surface tension of the liquid. Visible bubbling or boiling when the container is removed from the appliance is not always present. **THIS COULD RESULT IN VERY HOT LIQUIDS SUDDENLY BOILING OVER WHEN A SPOON OR OTHER UTENSIL IS INSERTED INTO THE LIQUID.**

To reduce the risk of injury to persons:

  - a Do not overheat the liquid.
  - b Stir the liquid both before and halfway through heating it.
  - c Do not use straight-sided containers with narrow necks. Use a wide-mouthed container.
  - d After heating, allow the container to stand in the appliance at least for 20 seconds before removing the container.
  - e Use extreme care when inserting a spoon or other utensil into the container.

# IMPORTANT SAFETY INSTRUCTIONS

---

**22** If Arcing (sparks inside the oven cavity) occurs, touch STOP/CLEAR.

Check the following:

- Ensure that all cookware is microwave-safe if using MICROWAVE or SPEED COOK functions.
- If using the top or bottom racks (for Convection and Speed Cook functions), ensure they are properly placed inside of the oven cavity and not touching the walls of the oven interior.
- If using aluminum foil (safe for Convection cooking modes only), ensure foil is properly molded on top of the food item with no edges turned up.

- No metal twist-ties, poultry pins or cookware with metal decorative trim are used inside the oven.
- No recycled paper towels (may contain bits of metal particles) are used to cover food or clean the oven.

**23** When using Speed Cook functions, the exterior of the appliance may also become hot.

**24** If the appliance light fails, consult a SHARP AUTHORIZED SERVICER.

## SAVE THESE INSTRUCTIONS

## INFORMATION YOU NEED TO KNOW

### ABOUT UNPACKING AND YOUR CONVECTION MICROWAVE DRAWER

A minimum of two people are required to handle the oven. Use the two handles located on each side of the oven to lift.

- 1 Remove all packing materials from inside the Convection Microwave Drawer and on the Drawer door.
- 2 Remove the feature sticker, if there is one. Check the drawer for any damage, such as misaligned or bent drawer, damaged drawer seals and sealing surfaces, broken or loose drawer guides and dents inside the cavity or on the front side of the drawer. If there is any damage, do not operate the Convection Microwave Drawer and contact your dealer or a SHARP AUTHORIZED SERVICER.

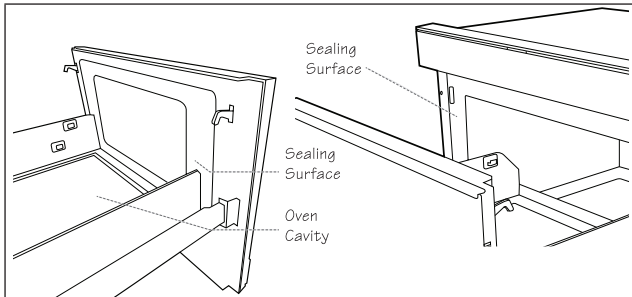

### RADIO OR TV INTERFERENCE

Should there be any interference caused by the Convection Microwave Drawer to your radio or TV, check that the Convection Microwave Drawer is on a different electrical circuit, relocate the radio or TV as far away from the drawer as feasible or check position and signal of receiving antenna.

## GROUNDING INSTRUCTIONS

The electrical requirements are a 120 volt 60 Hz, AC only, 15 amp. or more protected electrical supply.

It is recommended that a separate circuit serving only the Convection Microwave Drawer be provided. This appliance must be grounded. The Convection Microwave Drawer is equipped with a cord having a grounding wire with a grounding plug. It must be plugged into a wall receptacle that is properly installed and grounded in accordance with the National Electrical Code and local codes and ordinances. In the event of an electrical short circuit, grounding reduces risk of electric shock by providing an escape wire for the electric current.

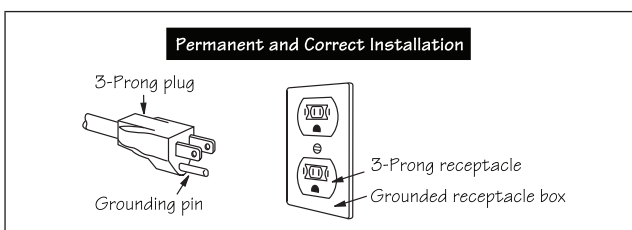

**WARNING** Improper use of the grounding plug can result in a risk of electric shock. **Do not use an extension cord. If the power supply cord is too short, have a qualified electrician or serviceworker install an outlet near the appliance.**

If you have any questions about the grounding or electrical instructions, consult a qualified electrician or serviceworker.

### ABOUT YOUR CONVECTION MICROWAVE DRAWER

ALWAYS have food in the Convection Microwave Drawer when it is on to absorb the microwave energy.

The vent under the Convection Microwave Drawer must not be blocked. During microwaving, steam may come from the left side lower vent (when facing the product).

When using the Convection Microwave Drawer at power levels below 100%, you may hear the magnetron cycling on and off. It is normal for the exterior of the Convection Microwave Drawer to be warm to the touch when cooking or reheating.

Condensation is a normal part of microwave cooking and the amount being vented is directly related to the moisture content of the food and room humidity. A cooler room will produce more condensation. Attention should be paid to the vented area after each use of the product and wiped down if needed.

After using Convection or Speed Cook, you will hear the sound of the cooling fan. The fan may continue to operate for an extended period of time, depending on the oven temperature. Be aware that, unlike microwave-only ovens, convection microwave ovens have a tendency to become hot during Convection and Speed Cook. The oven is for food preparation only. It should not be used to dry clothes or newspapers.

When using recipes or package directions, check food a minute or two before the minimum time and add time accordingly.

When opening or closing the Convection Microwave Drawer quickly, food in the Convection Microwave Drawer may be spilled. To clean, please refer to the Cleaning and Care section on page 35.

### ABOUT MICROWAVE COOKING

#### IMPORTANT - FOOD PLACEMENT

- Microwave cooking. Place all items directly on the bottom center of the drawer to allow maximum cooking performance. Do not elevate or microwave on the racks unless specified otherwise. Arrange food carefully. Place thickest areas toward outside of dish.

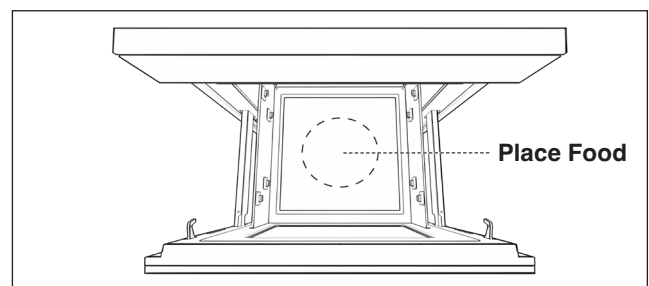



- Speed cook. This cook setting uses a low percentage microwave power plus convection heating which allows placements on racks. Follow instructions as noted under Speed Cook.

### ALSO NOTE:

- Watch cooking time. Cook for the shortest amount of time indicated and add more as needed. Food severely overcooked can smoke or ignite.
- Do not use metal dishes for microwave cooking. There is a risk of electric discharge or ignition.
- Cover foods while cooking. Check recipe or cookbook for suggestions, such as paper towels, wax paper, microwave plastic wrap or a lid. Covers prevent spattering and help foods to cook evenly.
- Stir foods from outside to center of dish once or twice during cooking, if possible.
- For best microwave cooking results, please ensure that the food to be microwaved is placed in the center of the floor of the microwave drawer. Do not elevate or place on the rack.
- Turn foods over once during microwaving to speed cooking of such foods as chicken and hamburgers. Large items like roasts must be turned over at least once.
- Rearrange foods such as meatballs halfway through cooking both from top to bottom and from right to left.
- Add standing time. Remove food from Convection Microwave Drawer and stir, if possible. Cover for standing time to allow food to finish cooking without overcooking.
- Check for doneness. Look for signs indicating that cooking temperatures have been reached.

Doneness signs include:

- Food steams throughout, not just at edge.
- Center bottom of dish is very hot to the touch.
- Poultry thigh joints move easily.
- Meat and poultry show no pinkness.
- Fish is opaque and flakes easily with a fork.

### ABOUT SAFETY

- Check foods to see that they are cooked to the United States Department of Agriculture's recommended temperatures.

---

145°F - Fish

---

160°F - Pork, ground beef/veal/lamb, egg dishes

---

165°F - Whole, pieces and ground turkey/chicken/duck  
Leftover, ready-to-reheat refrigerated, deli and carry-out fresh food

---

To test for doneness, insert a meat thermometer in a thick or dense area away from fat or bone. NEVER leave the thermometer in the food during cooking, unless it is approved for microwave use.

- ALWAYS use potholders to prevent burns when handling utensils that are in contact with hot food. Enough heat from the food can transfer through utensils to cause skin burns.
- Avoid steam burns by directing steam away from the face and hands. Slowly lift the farthest edge of a dish's covering

## INFORMATION YOU NEED TO KNOW

and carefully open popcorn and oven cooking bags away from the face.

- After cooking, the surfaces of the drawer, oven cavity and Convection Microwave Drawer guides will be extremely hot. Use caution to avoid contact of skin with hot surfaces to prevent burns and injury.
- Stay near the Convection Microwave Drawer while it's in use and check cooking progress frequently so that there is no chance of overcooking food.
- NEVER use the Convection Microwave Drawer for storing cookbooks or other items.
- Select, store and handle food carefully to preserve its high quality and minimize the spread of foodborne bacteria.

### SPECIFICATION

Voltage (Volts/Amps)	120V / 20A
Frequency	60 Hz
Microwave Output power (watts)	900W
Top Grill Ring Heater Wattage	1000W
Top 6 Pass Heater (3x 2-pass heaters)	1500W (3 x 500W)
Back Ring Heater Wattage	1500W

**Note:** Cooking times may vary depending on the microwave safe containers used.

### ABOUT FOODS

FOOD	DO	DON'T
Eggs, sausages, fruits & vegetables	<ul style="list-style-type: none"> <li>• Puncture egg yolks before cooking to prevent bursting.</li> <li>• Pierce skins of potatoes, apples, squash, hot dogs and sausages so that steam escapes.</li> </ul>	<ul style="list-style-type: none"> <li>• Cook eggs in shells.</li> <li>• Reheat whole eggs.</li> <li>• Dry nuts or seeds in shells.</li> </ul>
Popcorn	<ul style="list-style-type: none"> <li>• Use specially bagged popcorn for the microwave.</li> <li>• Listen while popping corn for the popping to slow to 1 or 2 seconds or use special <b>POPCORN</b> pad.</li> </ul>	<ul style="list-style-type: none"> <li>• Pop popcorn in regular brown bags or glass bowls.</li> <li>• Exceed maximum time on popcorn package.</li> </ul>
Baby food	<ul style="list-style-type: none"> <li>• Transfer baby food to small dish and heat carefully, stirring often. Check temperature before serving.</li> <li>• Put nipples on bottles after heating and shake thoroughly. Test temperature on wrist before feeding.</li> </ul>	<ul style="list-style-type: none"> <li>• Heat disposable bottles.</li> <li>• Heat bottles with nipples on.</li> <li>• Heat baby food in original jars.</li> </ul>
General	<ul style="list-style-type: none"> <li>• Cut baked goods with filling after heating to release steam and avoid burns.</li> <li>• Stir liquids briskly before and after heating to avoid eruption.</li> <li>• Use deep bowl when cooking liquids or cereals to prevent boilovers.</li> <li>• Food should be shorter than the Convection Microwave Drawer. Please refer to the height of side walls of the drawer.</li> </ul>	<ul style="list-style-type: none"> <li>• Heat or cook in closed glass jars or airtight containers.</li> <li>• Can in the microwave as harmful bacteria may not be destroyed.</li> <li>• Deep fat fry.</li> <li>• Dry wood, gourds, herbs or wet papers.</li> </ul>

### ABOUT UTENSILS AND COVERINGS

It is not necessary to buy all new cookware. Many pieces already in your kitchen can be used successfully in your new convection microwave oven. The chart below will help you decide what utensils and coverings should be used in each mode.

UTENSILS AND COVERINGS	MICROWAVE ONLY	CONVECTION	SPEED COOK
Aluminum foil	NO	YES. To cover	YES. To cover

## INFORMATION YOU NEED TO KNOW

UTENSILS AND COVERINGS	MICROWAVE ONLY	CONVECTION	SPEED COOK
Aluminum containers	NO	YES. Grill - No cover	YES. Uncovered and only 3/4 filled, maintaining 1" space between container walls and food.
Browning dish	NO	NO	NO
Glass ceramic (Pyroceram®)	YES. Excellent	YES. Excellent	YES. Excellent
Glass, heat-resistant	YES. Excellent	YES. Excellent	YES. Excellent
Glass, non-heat-resistant	NO	NO	NO
Lids, glass	YES	YES. Grill - No cover	YES
Lids, metal	NO	YES. Grill - No cover	NO
Metal cookware	NO	YES	NO
Metal, misc: dishes with metallic trim, screws, bands, handles. Metal twist ties	NO	NO	NO
Oven cooking bags	YES. For large meats or foods that need tenderizing. DO NOT use metal twist ties.	YES. Grill - No cover	YES. Do not use metal twist ties.
Paper plates	YES. For reheating.	NO	NO
Paper towels	YES. To cover for reheating and cooking. Do not use recycled paper towels which may contain metal fillings.	NO	NO
Oven-safe paper	YES	YES. For temperatures up to 400°F. Do not use for broiling.	YES. For temperatures up to 400°F.
Food storage bags/ brown paper bags	NO	NO	NO
Microwave-safe plastic containers	YES. For reheating and defrosting. Some microwave-safe plastics are not suitable for cooking foods with high fat and sugar content. Follow manufacturer's directions.	NO	NO
Plastic, Thermoset®	YES	YES. For temperatures up to 425°F. Do not use for broiling.	YES
Plastic wrap	YES. Use brands specially marked for microwave use. DO NOT allow plastic wrap to touch food. Vent so steam can escape.	NO	NO
Pottery, porcelain stoneware	YES. Check manufacturer's recommendation for being microwave-safe.	YES	YES. Must be microwave-safe and oven-safe.
Styrofoam	YES. For reheating.	NO	NO
Microwave-safe thermometers	YES	NO	NO
Regular cooking thermometers	NO. Regular cooking thermometers contain mercury that may cause arcing in the oven cavity.	YES	YES
Wax paper	YES. For covering.	NO	NO
Wicker, wood, straw	YES. With short cook times. For reheating foods with little or no fat or sugar content. Could char.	NO	NO

## PART NAMES

### CONVECTION MICROWAVE DRAWER

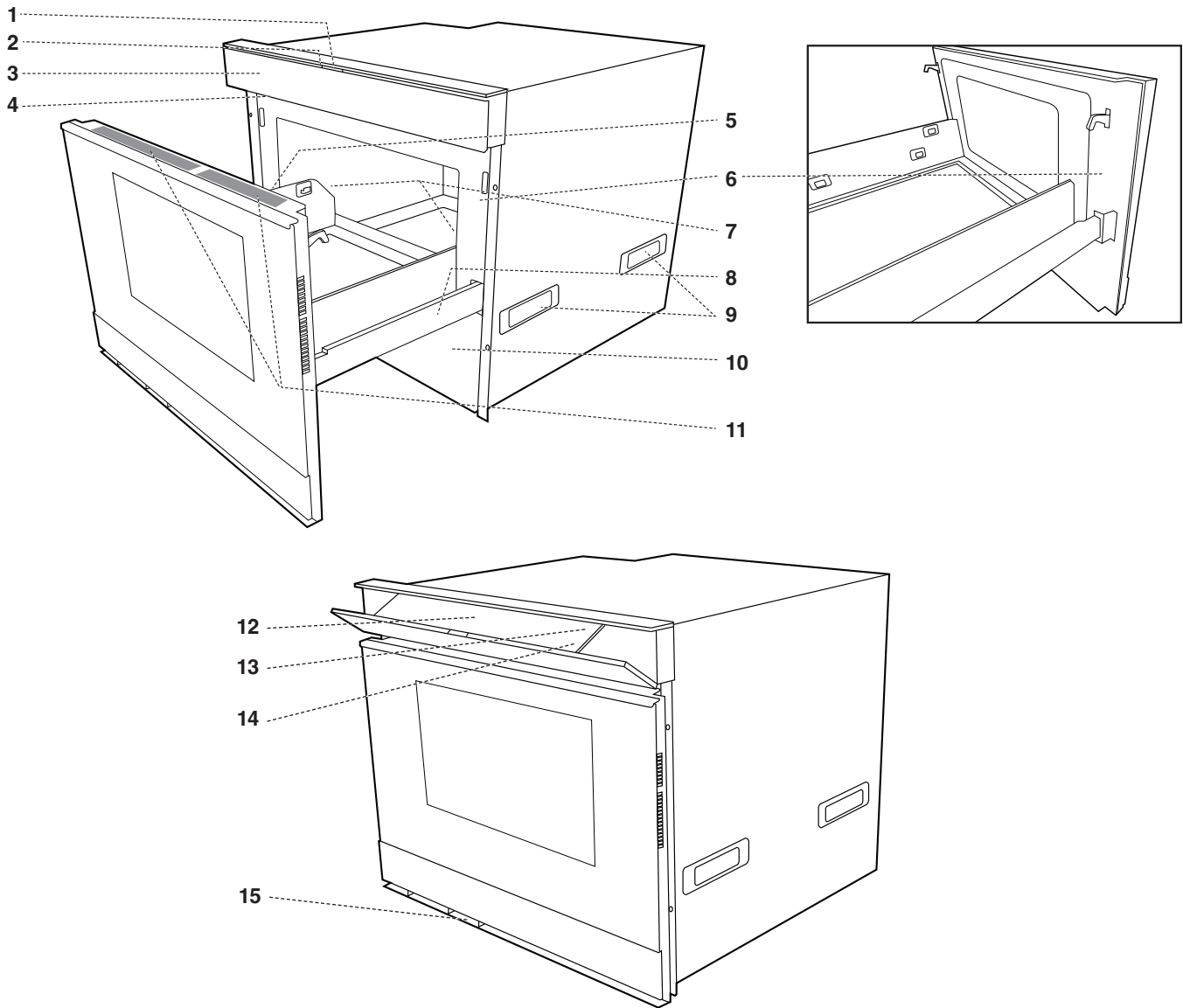

- |  |  |
|--|--|
| <ul style="list-style-type: none"> <li>1 Easy Wave Open indicator</li> <li>2 Wi-Fi indicator</li> <li>3 Hidden control panel door</li> <li>4 Easy Wave Open sensor</li> <li>5 Nameplate: Open the Convection Microwave Drawer fully. The label is located at the bottom left side of the oven face plate.</li> <li>6 Drawer sealing surfaces</li> <li>7 Drawer lights</li> </ul> | <ul style="list-style-type: none"> <li>8 Convection Microwave Drawer guides</li> <li>9 Handles</li> <li>10 Vent</li> <li>11 Menu labels</li> <li>12 Glass touch control</li> <li>13 Easy Wave Open button</li> <li>14 Wi-Fi Connect button</li> <li>15 Built-In flush mount</li> </ul> |
|--|--|

The glass touch control is hidden behind the control panel door on the top front face of the unit. To open, push in on the control panel. The panel will release and gently float to open. To close, push the panel upward to the closed position. The panel will be secured by magnetic latches in both open and closed positions.

**GLASS TOUCH CONTROL**



Numbers next to the glass touch control illustration indicate pages on which there are feature descriptions and usage information.

**MENU LABELS**

WARNING! HOT SURFACES	CONVECTION																																								
	MORE MENUS				SPEED COOK				AIR FRY		WARM		TOAST																												
	1. Biscuits	5. Brownies	9. Beef Burger	13. Frozen Classic Pizza	17. Flank Steak	21. Chicken Drumsticks	1. Speed Bake	1. Chicken Tenders	1. 90°F	1. Light	4. Medium	2. Dinner Rolls	6. Layered Cake	10. Turkey Burger	14. Frozen Rising Pizza	18. Pork Tenderloin	22. Boneless Chicken Breast	2. Speed Roast	2. French Fries	2. 150°F	2. Medium	4. Dark	3. Crescent Rolls	7. Fish Fillet	11. Veggie Burger	15. Fresh on Pizza Stone	19. Pork Chop	23. Whole Chicken	3. Speed Grill	3. Mozzarella Sticks	3. 200°F	3. Light	5. Dark	4. Cookies	8. Breaded Shrimp	12. Frozen Thin Pizza	16. Beef Roast	20. Bacon	24. Turkey Breast	4. Tater Tots	3. Medium

MICROWAVE												AVERTISSEMENT! CHAUD SURFACES																	
COOK				MORE MENUS				DEFROST																					
1. Baked Potato	5. White Rice	9. Frozen Vegetables	Melt	Softener	Warm	7. Beverage	1. Ground Meat	4. Bone-in Poultry	2. Steaks/Chops	5. Roast	6. Casserole and Soup	2. Sweet Potato	6. Quick Fresh Vegetables	10. Ground Meat	1. Butter	3. Ice Cream	5. Syrup	Reheat	8. Hot Water	9. Hot Cereal	3. Fish/Seafood	7. Longer Fresh Vegetables	11. Frozen Entrée	2. Chocolate	4. Cream Cheese	6. Dessert Toppings	3. Boneless Poultry	4. Brown Rice	8. Steamer Bag

**CONVECTION MICROWAVE OVEN APP**



## PART NAMES

### ACCESSORIES

The Top and Bottom Racks and Cook Tray are designed specifically for use in the Convection Microwave Drawer with Microwave-only, Air Fry, Convection and Speed Cook modes.

**Note:** The provided accessories are specifically designed to be used safely with microwave cooking functions. **DO NOT** place any other metal cookware inside the oven cavity when using Microwave-only and Speed Cook (convection and microwave power) cook functions.

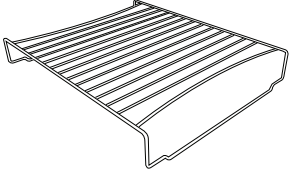
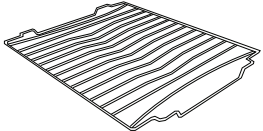
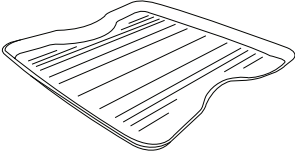
Top Rack	
Bottom Rack	
Cook/Drip Tray	

- Always use microwave-safe and oven-safe cookware when using Speed Cook functions as the oven combines microwave and conventional oven power.
- Always use potholders to prevent burns when handling utensils that are in contact with hot food. Enough heat from the food can transfer through utensils to cause skin burns.
- Be sure your accessories are clean and free of any food residue before each use to avoid damage to the accessories.

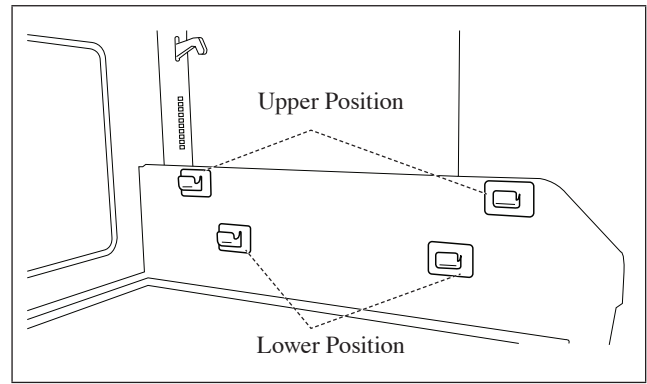

Use the correct accessories provided for each cooking mode. Place accessories in the correct installation position and direction.

### CONVECTION BAKE AND SPEED BAKE

- Use both racks for two level cooking.

#### FOR ONE LEVEL COOKING:

- To cook smaller food items, place the Top Rack in the lower position.
- To cook larger items such as bread loaves and Bundt cakes, place the Bottom Rack in the lower position.

### CONVECTION ROAST AND SPEED ROAST

- Use the Cook Tray as a drip tray to collect juices by placing the tray in the bottom of the oven cavity.

#### FOR ONE LEVEL COOKING:

- To cook larger food, place the Bottom Rack in the lower position and set the drip tray in the bottom of the oven.
- To cook smaller food, place the Top or Bottom rack in the lower position, set the food directly on the Drip Tray and place the Drip Tray on the rack.

### CONVECTION GRILL AND SPEED GRILL

- Use the Top Rack in either the upper or the lower position.
- Use the Bottom Rack in the lower position.

### AIR FRY

- Use the Top Rack in the lower position. See app for menu item instructions.

### DEFROST

- All Defrost modes use Microwave power. Ensure that any food items are placed inside of microwave-safe cookware before defrosting.
- Use a Drip Tray if desired for easier clean-up when defrosting Ground Meat, Steaks/Chops, Boneless Poultry, Bone-in Poultry and Roast.
- To defrost Casserole/Soup, place the cookware directly on the bottom of the oven without the Drip Tray.

Before operating your new Convection Microwave Drawer, make sure you read and understand this operation manual completely.

- Before the Convection Microwave Drawer can be used, follow these steps:
  - 1 Plug in the Convection Microwave Drawer. ENJOY YOUR OVEN TOUCH CLEAR will appear.
  - 2 Touch the STOP/CLEAR pad. : will appear.
  - 3 Set clock.

## TO SET THE CLOCK

- 1 Touch TIMER/SETTINGS pad once.
- 2 Touch number pads for correct time of day, touch START/+30 SEC.

This is a 12 hour clock. If you attempt to enter an incorrect clock time, ERROR will appear in the display. Touch the STOP/CLEAR pad and re-enter the time.

- If the electrical power supply to your Convection Microwave Drawer should be interrupted, the display will intermittently show ENJOY YOUR OVEN TOUCH CLEAR after the power is reinstated. If this occurs during cooking, the program will be erased. The time of day will also be erased. Simply touch STOP/CLEAR pad and reset the clock for the correct time of day.

### Note:

- The Convection Microwave Drawer can be programmed with the drawer open except for START/+30 SEC.

## TIME INCREMENTS CONVECTION VS. MICROWAVE

The Convection Microwave Drawer contains two different categories of cooking, convection and microwave. Due to their inherent differences, the time increments needed for their cooking are not the same. Convection items tend to cook longer and microwave items tend to cook quickly. Depending on which category you are using, the display provides an indicator to easily distinguish which time increment is being used.

For convection cooking items, "H" will be displayed. This represents the time increments of Hours and Minutes. Hours will be shown to the left of the colon, minutes to the right.



For microwave cooking items, "M" will be displayed. This represents the time increments of Minutes and Seconds. Minutes will be shown to the left of the colon and seconds to the right.



## STOP/CLEAR

Touch the STOP/CLEAR pad to:

- 1 Erase if you make a mistake during programming.
- 2 Cancel timer.
- 3 Stop the Convection Microwave Drawer temporarily during timed cooking.
- 4 Return the time of day to the display.
- 5 Cancel a program during cooking, touch twice for timed cooking.

## OPEN OR CLOSE CONVECTION MICROWAVE DRAWER

The Convection Microwave Drawer may be opened by any of the following methods:

- Touch the OPEN/CLOSE pad on the glass touch control. Touch OPEN/CLOSE again or gently push on the drawer to close.
- Wave twice on top left side of the drawer to open the oven drawer. The Easy Wave Open only works to open the drawer. Gently push on drawer or touch OPEN/CLOSE to close.
- Touch the OPEN DRAWER button on the app after pairing your appliance to the Sharp Kitchen app. The app only works to open the drawer. Gently push on drawer or touch OPEN/CLOSE to close.

Do not pull the drawer by hand, except in the case of a power failure.

## EASY WAVE OPEN ON/OFF

Easy Wave Open's default setting is OFF when plugged in. The white light on the center of the panel will illuminate once Easy Wave Open has been activated. When Control Lock is activated, the Easy Wave Open function is off.

To use the Easy Wave Open function, simply wave your hand in front of the sensor twice in consecutive motions. This can be either up and down or side to side motions.

### EASY WAVE OPEN ON

- Hold Number 5 on the glass touch control for 3 seconds. The display shows EASY WAVE OPEN ON.

### EASY WAVE OPEN OFF

- Hold Number 5 on the glass touch control for 3 seconds. The display shows EASY WAVE OPEN OFF.

## CONNECTING YOUR APPLIANCE

The Convection Microwave Drawer combines the technological enhancements of smart home connectivity with Sharp's innovative Convection Microwave Drawer design:

- Wi-Fi Connectivity
- Mobile App and Voice Control

Your Convection Microwave Drawer may be operated remotely through a mobile device using the Sharp Kitchen app in addition to conventional operation in a non-connected capacity using the Glass Touch Control on the oven door. To use the app, the appliance must be connected to your home network.

### WI-FI CONNECT

Your Convection Microwave Drawer is equipped with Wi-Fi connectivity. The oven's Wi-Fi will need to be turned ON in order to complete the Pairing process.

For instructions and how-to-pair video please visit: <http://www.sharppusa.com/support>.

### TURN OVEN'S WI-FI ON

- Touch the Number 0 (WiFi Connect) pad and hold for 3 seconds.

### TURN OVEN'S WI-FI OFF

- Touch the Number 0 (WiFi Connect) pad and hold for 3 seconds.

### FAVORITES:

The Sharp Kitchen app lets you select and store your Favorite Smart Cook items in your FAVORITES section. Click on the heart icon to add your most frequently prepared dishes.

### REMOTE START SAFETY INFORMATION

In order to operate the Convection Microwave Drawer with the Sharp Kitchen app, you must enable the Remote Start feature. The oven is preset to Remote Start OFF. It must be turned ON to utilize.

- Touch the TIMER/SETTINGS pad 3 times to access the Remote Start function to turn on or off.

When using mobile device operation to control the appliance remotely, be sure to follow all safety procedures and guidelines as instructed in the Operation Manual. Failure to do so may result in personal injury, death or damage to property.

### IMPORTANT NOTE:

There is a 3-minute window after opening and closing the drawer in which you may operate the oven remotely with the app. After 3 minutes of inactivity, you must operate the oven manually at the control panel or open and close the drawer again to operate remotely.

- If you activate the appliance remotely, your oven will remain ON and in cooking mode even if your mobile device or home Wi-Fi become disabled.

ALWAYS ensure the oven cavity is prepared for cooking when operating the oven remotely with the app. Risk of oven damage or fire could occur. NEVER use the oven interior as a storage device for unrelated items or cook using the app remotely if the cavity is not properly prepared. ALWAYS have food in the Convection Microwave Drawer when it is on to absorb the microwave energy.

Touching the STOP/CLEAR pad ONCE on the oven control panel will pause the preheat or cook cycle whether initiated on the oven control panel or with Remote Start on the app.

**⚠ WARNING** Convection and SPEED COOK functions produce high heat temperatures. ALWAYS MONITOR OVEN USE WHEN USING THE APP TO CONTROL THE OVEN.

### PAIRING

Pairing may be used to pair a new mobile device to the oven after the oven has already been connected to your home network.

For instructions and how-to-pair video please visit: <http://www.sharppusa.com/support>

- Touch the TIMER/SETTINGS pad 4 times to access the Pairing function.

### WI-FI INFORMATION

Wi-Fi Information provides your oven's MAC address on your home network. This information may be requested if you contact SHARP Customer Assistance.

- Touch the TIMER/SETTINGS pad 5 times to access the Wi-Fi Information function.

### WI-FI FIRMWARE UPDATES

From time to time, updates to the oven's software will be released. Notifications will be sent via the Sharp Kitchen app for these updates. The firmware updates will be available on the product support page. Please visit: [www.sharppusa.com/support](http://www.sharppusa.com/support) for more information.

- Touch the TIMER/SETTINGS pad 6 times to access the Wi-Fi Firmware Update function.

### WI-FI RESET

Your oven's Wi-Fi settings may be cleared by using the Wi-Fi Reset function. Clearing of settings may need to be performed when a new router or Wireless LAN is installed in the home or if transferring ownership of the oven. See also CAUTION FOR PERSONAL INFORMATION (RELATED TO SECURITY) on page 5 for further information.

- Touch the TIMER/SETTINGS pad 7 times to access the Wi-Fi Reset function.

### OVEN CONTROL HIERARCHY

Touching the STOP/CLEAR pad ONCE on the oven control panel will pause the preheat or cook cycle whether initiated on the oven control panel or with Remote Start on the app.

Touching the STOP/CLEAR pad TWICE on the oven control panel will cancel and clear all preheat and cook cycle settings including those initiated with Remote Start on the app.



## ABOUT MICROWAVE COOKING

### IMPORTANT - FOOD PLACEMENT

- Microwave cooking. Place all items directly on the bottom center of the drawer to allow maximum cooking performance. Do not elevate

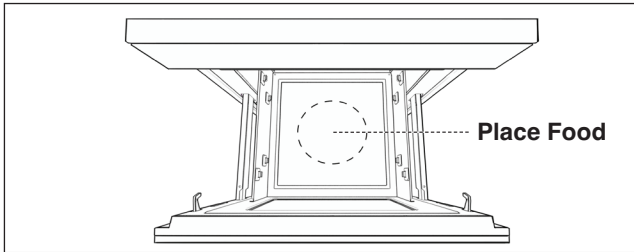

or microwave on the racks unless specified otherwise. Arrange food carefully. Place thickest areas toward outside of dish.

- Speed cook. This cook setting uses a low percentage microwave power plus convection heating which allows placements on racks. Follow instructions as noted under Speed Cook.

### TIME COOKING

Your Convection Microwave Drawer can be programmed for 99 minutes 99 seconds (99.99). Always enter the seconds after the minutes, even if they are both zeros.

- Suppose you want to cook for 5 minutes at 100%.
  - 1 Enter cooking time 5 0 0.
  - 2 To cook at 100% power (High), touch START/+30 SEC pad.

### TO SET POWER LEVEL

There are eleven preset power levels.

Using lower power levels increases the cooking time, which is recommended for foods such as cheese and milk and long, slow cooking of meats. Consult a microwave cookbook or recipes for specific recommendations.

- Suppose you want to defrost for 5 minutes at 30%.
  - 1 Enter defrost time 5 0 0.
  - 2 Touch POWER LEVEL pad 8 times.
  - 3 Touch START/+30 SEC pad.

TOUCH POWER LEVEL PAD NUMBER OF TIMES FOR DESIRED POWER	APPROXIMATE PERCENTAGE OF POWER	COMMON WORDS FOR POWER LEVELS
POWER LEVEL x 1	100%	High
POWER LEVEL x 2	90%	
POWER LEVEL x 3	80%	
POWER LEVEL x 4	70%	Medium High
POWER LEVEL x 5	60%	
POWER LEVEL x 6	50%	Medium
POWER LEVEL x 7	40%	
POWER LEVEL x 8	30%	Med Low /Defrost
POWER LEVEL x 9	20%	
POWER LEVEL x 10	10%	Low
POWER LEVEL x 11	0%	

### SENSOR SETTINGS

Sharp's Sensor is a semi-conductor device that detects the vapor (moisture and humidity) emitted from the food as it heats. The sensor adjusts the cooking times and power levels for various foods and quantities.

#### USING SENSOR SETTINGS:

- 1 After the Convection Microwave Drawer is plugged in, wait 2 minutes before using any sensor setting.
- 2 Be sure the exterior of the cooking container and the interior of the Convection Microwave Drawer are dry. Wipe off any moisture with a dry cloth or paper towel.
- 3 The sensor works with foods at normal storage temperature. For example, popcorn would be at room temperature.
- 4 Any sensor selection can be programmed with More or Less Time Adjustment. See page 33.
- 5 More or less food than the quantity listed in the charts should be cooked following the guidelines in any microwave cookbook.
- 6 During the first part of sensor use, the food name will appear on the display. Do not open the Convection Microwave Drawer or touch STOP/CLEAR during this part of the cycle. The measurement of vapor will be interrupted. If this occurs, an error message will appear. To continue cooking, touch the STOP/CLEAR pad and cook manually.

When the sensor detects the vapor emitted from the food, the remainder of cooking/reheating time will appear. The Convection Microwave Drawer may be opened when the remaining time appears on the display. At this time, you may stir or season food, as desired.

- 7 Except for Popcorn, if the sensor does not detect vapor properly when cooking other foods, ERROR will be displayed, and the microwave will turn off.
- 8 Check food temperature after cooking. If additional time is needed, continue to cook manually.
- 9 Each food has a cooking hint. Touch the TIMER/ SETTINGS pad when the HELP indicator is lighted in the display.

# MICROWAVE OVEN COOKING

## COVERING FOODS:

Some foods cook best when covered. Only use the recommended covers for these foods. See pages 10-11 for recommendations. You may refer to the hints by touching the TIMER/SETTINGS pad. Some recommended covers are:

- 1 Casserole lid.
- 2 Plastic wrap: Use plastic wrap recommended for microwave cooking. Cover dish loosely, allowing approximately 1/2 inch to remain uncovered to allow steam to escape. Plastic wrap should not touch food.
- 3 Wax paper: Cover dish completely, folding excess wrap under dish to secure. If dish is wider than paper, overlap two pieces at least one inch to cover.

Be careful when removing any covering to allow steam to escape away from you.

## SENSOR

### POPCORN, REHEAT, COOK

You can cook or reheat many foods and don't need to calculate cooking time or power level.

- Suppose you want to cook baked potatoes.
- 1 Touch Cook pad once.
  - 2 See Menu Label. Select desired food by touching number pad. Ex: Touch 1 for baked potatoes.
  - 3 Touch START/+30 SEC pad.

#### Note:

- To heat or cook other foods or foods above or below the quantity allowed on the chart, cook manually.

## POPCORN, REHEAT CHART

FOOD	AMOUNT	PROCEDURE
Popcorn	Only 1 package at a time	Only cook one microwave popcorn package at a time with the appropriate side facing up. After cooking, remove and open carefully to allow steam to escape.
	2.85 - 3.5 oz (Regular/Regular light)	Touch POPCORN pad once.
	1.2 - 1.75 oz (Mini/Snack)	Touch POPCORN pad twice.
Reheat	4 - 36 oz	Use microwave-safe cookware and cover with lid, plastic wrap or wax paper. <b>Note:</b> The tighter the cover, the hotter the food will be. However, it is necessary to leave a small vent for the steam/moisture to escape from the food as it heats. After reheating, stir well, if possible. Re-cover and allow to stand 2 to 3 minutes.

# MICROWAVE OVEN COOKING

## COOK CHART

FOOD	AMOUNT	PROCEDURE															
<b>1</b> Baked Potatoes	1 - 6 medium	Pierce the potatoes at least 3 times each on the top, bottom and sides. Piercing allows steam to escape. Place on paper towel in Convection Microwave Drawer. After cooking, remove from microwave, wrap in aluminum foil and let stand 5 to 10 minutes.															
<b>2</b> Sweet Potatoes	1 - 6 medium																
<b>3</b> Fish/Seafood	0.5 - 2.0 lb	Arrange fish or seafood in ring around shallow glass dish (roll fillet with edges underneath). Cover with vented plastic wrap. After cooking, let stand, covered, for 3 minutes.															
<b>4</b> Brown Rice	0.5 - 2.0 cups	Place rice into a deep casserole and add double quantity of water. Cover with lid or plastic wrap. After cooking, stir, cover and let stand 3 to 5 minutes or until all liquid has been absorbed.															
<b>5</b> White Rice	0.5 - 2.0 cups																
		<table> <thead> <tr> <th>Rice</th> <th>Water</th> <th>Size of casserole</th> </tr> </thead> <tbody> <tr> <td>0.5 cup .....</td> <td>1 cup .....</td> <td>1.5 quarts</td> </tr> <tr> <td>1 cup .....</td> <td>2 cups .....</td> <td>2 quarts</td> </tr> <tr> <td>1.5 cups .....</td> <td>3 cups .....</td> <td>2.5 or 3 quarts</td> </tr> <tr> <td>2 cups .....</td> <td>4 cups .....</td> <td>3 quarts or larger</td> </tr> </tbody> </table>	Rice	Water	Size of casserole	0.5 cup .....	1 cup .....	1.5 quarts	1 cup .....	2 cups .....	2 quarts	1.5 cups .....	3 cups .....	2.5 or 3 quarts	2 cups .....	4 cups .....	3 quarts or larger
Rice	Water	Size of casserole															
0.5 cup .....	1 cup .....	1.5 quarts															
1 cup .....	2 cups .....	2 quarts															
1.5 cups .....	3 cups .....	2.5 or 3 quarts															
2 cups .....	4 cups .....	3 quarts or larger															
<b>6</b> Quick Fresh Vegetables		Wash and place in casserole. Add no water if vegetables have just been washed. Cover with lid for tender vegetables. Use plastic wrap for tender-crisp vegetables. After cooking, stir, if possible. Let stand, covered, for 2 to 5 minutes.															
Broccoli	0.25 - 2.0 lb																
Brussels sprouts	0.25 - 2.0 lb																
Cabbage	0.25 - 2.0 lb																
Cauliflower (flowerets)	0.25 - 2.0 lb																
Cauliflower (whole)	1 medium																
Spinach	0.25 - 1.0 lb																
Zucchini	0.25 - 2.0 lb																
Baked apples	2 - 4 medium																
<b>7</b> Longer Fresh Vegetables		Place in casserole. Add 1 - 4 tablespoons water. Cover with lid for tender vegetables. Use plastic wrap cover for tender-crisp vegetables. After cooking, stir, if possible. Let stand, covered, for 2 to 5 minutes.															
Carrots, sliced	0.25 - 1.5 lb																
Corn on the cob	2 - 4																
Green beans	0.25 - 1.5 lb																
Winter squash:																	
diced	0.25 - 1.5 lb																
halves	1 - 2																
<b>8</b> Steamer Bag	6 - 17 oz	Place bag in the microwave drawer with the appropriate side facing up. Follow instructions on the bag. After cooking, remove and open carefully to allow steam to escape.															
<b>9</b> Frozen Vegetables	0.25 - 1.25 lb	Add no water. Cover with lid or plastic wrap. After cooking, stir and let stand, covered, for 3 minutes.															
<b>10</b> Ground Meat	0.25 - 2.0 lb	Use this setting to cook ground beef or turkey as patties or in a casserole to be added to other ingredients. Place patties on a microwave-safe dish and cover with wax paper. Place ground meat in a casserole dish and cover with wax paper or plastic wrap. When microwave pauses, turn patties over or stir meat in casserole to break up large pieces. Re-cover and touch START/+30 SEC. After cooking, let stand, covered, for 2 to 3 minutes.															
<b>11</b> Frozen Entrée	6 - 17 oz	Remove entrée from outer packaging and follow package directions for covering. After cooking, let stand, covered, for 1 to 3 minutes.															

# MICROWAVE OVEN COOKING

## DEFROST

Use this feature to defrost the foods shown in the DEFROST CHART below.

- 1 Touch DEFROST pad.
- 2 See Menu Label. Select desired food by touching the number pad. Ex: Touch 2 for steaks/chops.
- 3 Enter weight by touching number pads.
- 4 Touch START/+30 SEC pad.  
The oven will stop so that the food can be checked.
- 5 After the first stage, open the Convection Microwave Drawer to turn steak over. Close the Convection Microwave Drawer. Touch START/+30 SEC pad.
- 6 After each audible signal, turn food over and select START/+30 SEC again.

After defrost cycle ends, cover and let stand as indicated in the chart below.

### Note:

- Defrost can be programmed with More or Less Time Adjustment. See page 33.
- To defrost other foods or foods above or below the weights allowed on the DEFROST CHART, see MANUAL DEFROST below.
- Check foods when oven signals. After final stage, small sections may still be icy. Let stand to continue thawing. Do not cook until all ice crystals are thawed.

## DEFROST CHART

FOOD	AMOUNT	PROCEDURE
1 Ground Meat	0.5 - 2.0 lb	After each audible signal, remove any thawed pieces and select <b>START/+30 SEC</b> again. After cooking, let stand, covered, for 5 to 10 minutes.
2 Steaks/Chops	0.5 - 3.0 lb	After each audible signal, turn food over and select <b>START/+30 SEC</b> again. After cooking, let stand, covered, for 10 to 20 minutes.
3 Boneless Poultry	0.5 - 2.0 lb	After each audible signal, turn food over and select <b>START/+30 SEC</b> again. After cooking, let stand, covered, for 10 to 20 minutes.
4 Bone-in Poultry	0.5 - 3.0 lb	After each audible signal, turn food over and select <b>START/+30 SEC</b> again. After cooking, let stand, covered, for 10 to 20 minutes.
5 Roast	2.0 - 4.0 lb	After each audible signal, turn food over and select <b>START/+30 SEC</b> again. After cooking, let stand, covered, for 30 to 60 minutes.
6 Casserole Soup	2 - 6 cups 1 - 6 cups	After each audible signal, break apart and remove any defrosted part. After cooking, stir well and let stand, covered, for 5 to 10 minutes.

## MANUAL DEFROST

If the food that you wish to defrost is not listed on the DEFROST CHART or is above or below the limits in the AMOUNT column on the DEFROST CHART, you need to defrost manually.

You can defrost any frozen food, either raw or previously cooked, by using POWER LEVEL at 30%. Follow the exact 3-step procedure found under TO SET POWER LEVEL on page 17. Estimate defrosting time and touch POWER LEVEL pad eight times for 30% power.

For either raw or previously cooked frozen food, the rule of thumb is approximately 4 minutes per pound. For example, defrost 4 minutes for 1 pound of frozen spaghetti sauce.

Always stop the oven periodically to remove or separate the portions that are defrosted. If food is not defrosted at the end of the estimated defrosting time, program the oven in 1 minute increments on POWER LEVEL 30% until totally defrosted.

When using plastic containers from the freezer, defrost only long enough to remove from the plastic in order to place in a microwave-safe dish.

## MORE MENUS (MICROWAVE)

### MELT/SOFTEN/WARM

These features automatically compute the correct heating time and microwave power level for melting, softening and warming foods shown in the chart below.

- 1 Touch MORE MENUS pad once.
- 2 See Menu Label. Select desired food by touching number pad. Ex: Touch 2 for chocolate.
- 3 Repeat touching same number pad to select quantity.  
Ex: Touch 2 two more times for 1 square.
- 4 Touch START/+30 SEC pad.

**Note:**

- Melt/Soften/Warm can be programmed with More or Less Time Adjustment. See page 33.
- To melt, soften or warm other food or foods above or below the quantity allowed on the MELT/SOFTEN/WARM CHART, use manual operation.

### MELT/SOFTEN/WARM CHART

FOOD	AMOUNT	PROCEDURE
<b>Melt</b>		
Use a Pyrex measuring cup. Cover with plastic wrap.		
1 Butter	2 tbsp	After touching MORE MENUS, touch 1 two times for 2 tbsp.
	1/2 cup	After touching MORE MENUS, touch 1 three times for 1/2 cup.
2 Chocolate	1 cup chips	After touching MORE MENUS, touch 2 two times for 1 cup chips.
	1 square	After touching MORE MENUS, touch 2 three times for 1 square.
<b>Soften</b>		
DO NOT COVER.		
3 Ice cream	1 pint	After touching MORE MENUS, touch 3 two times for 1 pint.
	1.5 qt	After touching MORE MENUS, touch 3 three times for 1.5 quarts.
4 Cream cheese	3 oz	After touching MORE MENUS, touch 4 two times for 3 oz
	8 oz	After touching MORE MENUS, touch 4 three times for 8 oz
<b>Warm</b>		
Use a Pyrex measuring cup. DO NOT COVER.		
5 Syrup	0.25 cup	After touching MORE MENUS, touch 5 two times for 0.25 cup.
	0.5 cup	After touching MORE MENUS, touch 5 three times for 0.5 cup.
6 Dessert Toppings	0.25 cup	After touching MORE MENUS, touch 6 two times for 0.25 cup.
	0.5 cup	After touching MORE MENUS, touch 6 three times for 0.5 cup.

## MICROWAVE OVEN COOKING

### BEVERAGE REHEAT / HOT WATER / HOT CEREAL

These features enable you to reheat coffee or tea to restore to a more suitable drinking temperature or to make instant coffee, tea or hot cereal.

- Suppose you want to make 2 cups of coffee.
- 1** Touch MORE MENUS pad once.
  - 2** See Menu Label. Make selection by touching number pad.  
Ex: Touch 8 to make coffee.
  - 3** Repeating touching same number pad to select quantity.  
Ex: Touch 8 two more times for 2 cups of coffee.
  - 4** Touch START/+30 SEC pad.

**Note:**

- Beverage Reheat/Hot Water/Hot Cereal can be programmed with More or Less Time Adjustment. See page 33.
- Should you attempt to enter more or less than the allowed amount, an error message will appear in the display.

### BEVERAGE REHEAT / HOT WATER / HOT CEREAL CHART

FOOD	AMOUNT	PROCEDURE
<b>7</b> Beverage Reheat	0.5 - 2 cups	This setting is good for restoring a cooled beverage to a better drinking temperature. Touch number 7 pad for a 0.5 cup increase per touch. Stir after heating.
<b>8</b> Hot Water	1 - 6 cups	Use this setting for heating COLD TAP WATER to a temperature somewhat below the boiling point to make instant coffee or tea. Touch number 8 pad for 1 cup increase per touch. Stir liquid briskly before and after heating to avoid eruption.
<b>9</b> Hot Cereal	1 - 6 servings	Use individual packets or bulk cereal in your favorite variety: oatmeal, oat bran, cream of wheat, farina or wheatena. Follow the package directions for the correct amount of water or milk. To prevent boilovers, it is very important to choose a large container because microwave cooking of cereal causes high boiling. Touch number 9 pad for 1 serving increase per touch. If the oven stops, stir and touch START/+30 SEC. After cooking, stir and let stand, covered, for 2 minutes.

## CONVECTION COOKING - PRESETS

Sharp's innovative design combines convection and microwave cooking to create dishes that range from convenience food items to delicious gourmet meals.

### MORE MENUS (CONVECTION)

The following pages provide instructions for using the Convection cooking modes available in More Menus to Bake, Grill and Roast foods with preset temperature and cooking times.

Touch **TIMER/SETTINGS** pad anytime **HELP** is illuminated on the oven display for details on food selection quantity.

**CAUTION** The oven cabinet, cavity, door, tray, racks and dishes will become hot. To **PREVENT BURNS**, use thick oven gloves when removing the food from the oven.

### CONVECTION BAKE

Convection Bake automatically bakes breads, desserts, seafood, pizza and air fry foods.

- To bake biscuits:

- 1 Touch the **MORE MENUS** pad.
- 2 See Menu Label. Make selection by touching number pad. Ex: Touch 1 for biscuits.
- 3 Touch **START/+30 SEC** pad to begin preheating.

After the preheat cycle ends, an audible signal will sound 4 beeps to indicate the preheat cycle is complete. Open the drawer to place food inside the oven.

- 4 Touch **START/+30 SEC** pad to begin cooking.

### CONVECTION ROAST

Convection Roast automatically roasts certain cuts of beef, pork and poultry.

- To roast pork tenderloin:

- 1 Touch the **MORE MENUS** pad.
- 2 Make selection by touching number pad. Ex: touch 1 8 for pork tenderloin. See Menu Label.
- 3 Touch **START/+30 SEC** pad to begin preheating.  
After the preheat cycle ends, an audible signal will sound 4 beeps to indicate the preheat cycle is complete. Open the drawer to place food inside the oven.
- 4 Touch **START/+30 SEC** pad to begin cooking.

### CONVECTION GRILL

Convection Grill automatically grills certain cuts of fish and seafood, beef, pork and burger patties.

- To grill hamburgers:

- 1 Touch the **MORE MENUS** pad.
- 2 See Menu Label. Make selection by touching number pad. Ex: Touch 1 0 for turkey burgers.
- 3 Touch **START/+30 SEC** pad to begin preheating.

After the preheat cycle ends, an audible signal will sound 4 beeps to indicate the preheat cycle is complete. Open the drawer to place food inside the oven.

- 4 Touch **START/+30 SEC** pad to begin cooking.

### MORE MENUS (CONVECTION) CHART

SETTING/FOOD	AMOUNT	METHOD	PROCEDURE
1 Biscuits (Canned)	6 - 12 pieces	Convection Bake	Preheat drawer. Place 6 to 12 large canned biscuits evenly spaced on a sheet tray. Place sheet tray on the bottom rack in the lower position after preheating the drawer. Biscuit brands and sizes vary. See package instructions. Biscuits are done when golden brown on top. To cook more than 12 pieces, put the additional biscuits on a sheet tray on the top rack in the upper position.
2 Dinner Rolls (Frozen)	10 - 20 pieces	Convection Bake	Follow package instructions to thaw and proof yeast dinner rolls (generally, set out for 3 hours at room temperature). Preheat drawer. Place 10 to 20 thawed/proofed dinner rolls evenly spaced on a sheet tray. Place sheet tray on the bottom rack in the lower position after preheating the drawer. Dinner roll brands and sizes vary. See package instructions. Dinner rolls are done when golden brown on top. Brush the tops with melted butter when hot out of the drawer for added flavor. To cook more than 20 pieces, put the additional dinner rolls on a sheet tray on the top rack in the upper position.
3 Crescent Rolls (Canned)	4 - 8 pieces	Convection Bake	Preheat drawer. Place 4 to 8 canned crescent rolls evenly spaced on a sheet tray. Place sheet tray on the bottom rack in the lower position after preheating the drawer. Crescent roll brands and sizes vary. See package instructions. Crescent rolls are done when golden brown on top. To cook more than 8 pieces, put additional rolls on a sheet tray on the top rack in the upper position.

## CONVECTION COOKING - PRESETS

### MORE MENUS (CONVECTION) CHART

SETTING/FOOD	AMOUNT	METHOD	PROCEDURE
<b>4</b> Cookies	6 - 12 pieces	Convection Bake	Preheat drawer. Use prepackaged cookie dough mix. Follow spacing guidelines on package and place 6 to 12 cookies on a sheet tray. Place sheet tray on the bottom rack in the lower position after preheating the drawer. Different size and brands vary in time. Cookies are done when the edges are firm. To cook more than 12, put additional cookies on a sheet tray on the top rack in the upper position.
<b>5</b> Brownies	1 pan (8 x 8-inch)	Speed Bake	Place top rack in the lower position of the drawer and begin preheating. Grease an 8 x 8-inch microwave-safe baking dish and add brownie mix. Set dish on the rack after preheating the drawer. ALWAYS use glass or silicone bakeware and microwave-safe dishes with SPEED COOK as the drawer uses microwave and convection during cooking. Brownies are done when a toothpick inserted in the center comes out clean. Placing rack in the drawer during preheat allows for faster and more even cooking.
<b>6</b> Layered Cake	1 or 2 pans (8-inch round)	Convection Bake	Place the top rack in the upper position and the bottom rack in the lower position and begin preheating. Grease two 8-inch round cake pans and place in the center of racks after preheating the drawer. If only baking 1 pan, use the top rack in the lower position. The cake is done when a toothpick inserted in the center comes out clean. Placing racks in the drawer during preheat allows for faster and more even cooking.
<b>7</b> Fish Fillet	2 - 4 fillets (6 - 10 oz each)	Convection Roast	Preheat drawer. Season as desired and evenly space 2 to 4 fillets on the cook tray. Place on the top rack in the lower position after preheating the drawer. Works well for thicker fillets such as salmon and cod. Different thickness of fillets cook differently. Monitor doneness during cooking.
<b>8</b> Breaded Shrimp	6 - 18 pieces	Convection Roast	Preheat drawer. Evenly space 6 to 18 breaded shrimp on a sheet tray. Place sheet tray on top rack in the lower position after preheating the drawer. Breaded shrimp brands and sizes vary. See package instructions. The shrimp are done when golden brown.
<b>9</b> Beef Burger	2 - 6 patties (1/2-inch thick, 6 oz each)	Convection Grill	Place the cook tray on the top rack in the lower position and begin preheating. Season as desired and evenly space 2 to 6 patties on the cook tray after preheating the drawer. When drawer pauses, flip patties over and touch START/+30 SEC. After cooking, let stand for 2 to 3 minutes. Different thickness of patties cook differently. Monitor doneness during cooking. For cheeseburgers, add cheese on top of patty, leave in the drawer with door closed for an additional 2 to 3 minutes after cooking complete, then remove from drawer. Placing cook tray in the drawer during preheat allows for faster and more even cooking.
<b>10</b> Turkey Burger	2 - 6 patties (1/2-inch thick, 6 oz each)	Convection Grill	Place the cook tray on the top rack in the lower position and begin preheating. Season as desired and evenly space 2 to 6 patties on the cook tray after preheating the drawer. When drawer pauses, flip patties over and touch START/+30 SEC. After cooking, let stand for 2 to 3 minutes. Different thickness of patties cook differently. Monitor doneness during cooking. For cheeseburgers, add cheese on top of patty, leave in the drawer with door closed for an additional 2 to 3 minutes after cooking complete, then remove from drawer. Placing cook tray in the drawer during preheat allows for faster and more even cooking.
<b>11</b> Veggie Burger	2 - 6 patties (3 - 4 oz each)	Convection Grill	Set cook tray in the drawer to use as a drip tray. Place the top rack in the upper position and begin preheating. Season as desired and evenly space 2 to 6 patties directly on top of rack after preheating the drawer. When drawer pauses, flip patties over and touch START/+30 SEC. After cooking, let stand for 2 to 3 minutes. Different thickness of patties cook differently. Monitor doneness during cooking. For cheeseburgers, add cheese on top of patty, leave in the drawer with door closed for an additional 2 to 3 minutes after cooking complete, then remove from drawer. Placing cook tray in the drawer during preheat allows for faster and more even cooking.



## CONVECTION COOKING - PRESETS

### MORE MENUS (CONVECTION) CHART

SETTING/FOOD	AMOUNT	METHOD	PROCEDURE
<b>12</b> Frozen Thin Crust Pizza	1 (12-inch)	Convection Roast	Set cook tray in the drawer to use as a drip tray. Place top rack in the lower position and begin preheating. Place one 12-inch frozen pizza directly on the rack after preheating the drawer. Pizza brands and cook times vary. See package instructions. The pizza is done when the cheese is melted and the crust is golden brown. Placing cook tray in the drawer during preheat allows for faster and more even cooking.
<b>13</b> Frozen Classic Crust Pizza	1 (12-inch)	Convection Roast	Set cook tray in the drawer to use as a drip tray. Place top rack in the lower position and begin preheating. Place one 12-inch frozen pizza directly on the rack after preheating the drawer. Pizza brands and cook times vary. See package instructions. The pizza is done when the cheese is melted and the crust is golden brown. Placing cook tray in the drawer during preheat allows for faster and more even cooking.
<b>14</b> Frozen Rising Crust Pizza	1 (12-inch)	Convection Roast	Set cook tray in the drawer to use as a drip tray. Place top rack in the lower position and begin preheating. Place one 12-inch frozen pizza directly on the rack after preheating the drawer. Pizza brands and cook times vary. See package instructions. The pizza is done when the cheese is melted and the crust is golden brown. Placing cook tray in the drawer during preheat allows for faster and more even cooking.
<b>15</b> Fresh Pizza on Pizza Stone	1 (12-inch)	Convection Roast	Place the top rack in the lower position, place a 12-inch pizza stone on rack and begin preheating. Allow an extra 30 minutes for pizza stone to come to the correct temperature. Gently stretch dough into a 12-inch round. Transfer dough to floured pizza peel and add desired toppings. Coming carefully from the side of the oven drawer, use peel to slide pizza onto pizza stone. Use caution when using the pizza stone, as it will be very hot.
<b>16</b> Beef Roast	2.0 - 4.0 lb	Convection Roast	Place the bottom rack in the lower position of the drawer. Use the slider bar to select the weight and begin preheating. Set roast on the cook tray and season roast as desired. Place the cook tray on the rack after preheating the drawer. Covering the roast with foil and letting it stand after cooking allows the juices to redistribute, creating a moist interior while maintaining a crispy, browned exterior.
<b>17</b> Flank Steak	1.5 - 2.0 lb	Convection Grill	Place the cook tray on the top rack in the upper position and begin preheating. Season steak as desired and place in the center of cook tray after preheating the drawer. When drawer pauses, turn steak over and touch START/+30 SEC. After cooking, let stand for 3 to 5 minutes. Placing the cook tray in the drawer during preheat aids in browning of the steak and allows for faster and more even cooking. If using a glaze or sauce with high sugar content, for example barbeque sauce, use the top rack in the lower position to prevent burning of glaze or sauce.
<b>18</b> Pork Tenderloin	0.75 - 1.5 lb	Convection Roast	Set cook tray in the drawer to use as a drip tray. Place the bottom rack in the lower position and begin preheating. Season as desired and place the tenderloin directly on the rack after preheating the drawer. Tenderloin sizes and thicknesses vary. Use an instant-read thermometer to ensure pork has reached 160°F. Placing rack in the drawer during preheat allows for faster and more even cooking.
<b>19</b> Pork Chop (Boneless)	2 - 5 pieces (1/2-inch thick, 6 - 9 oz each)	Convection Grill	Place the cook tray on the top rack in the upper position and begin preheating. Season chops as desired and place in the center of cook tray after preheating the drawer. When drawer pauses, turn chops over and touch START/+30 SEC. After cooking, let stand for 3 to 5 minutes. Placing the cook tray in the drawer during preheat aids in browning of the chops and allows for faster and more even cooking. If using a glaze or sauce with high sugar content, for example barbeque sauce, use the top rack in the lower position to prevent burning of glaze or sauce.

## CONVECTION COOKING - PRESETS

### MORE MENUS (CONVECTION) CHART

SETTING/FOOD	AMOUNT	METHOD	PROCEDURE
<b>20</b> Bacon	3 - 8 slices	Speed Cook Bake	Place bacon on cook tray and set directly on the bottom of the drawer. <b>Note:</b> If using another dish instead of provided cook tray, ensure it is oven-safe and ALWAYS use glass or silicone bakeware and microwave-safe dishes with SPEED COOK as the drawer uses microwave and convection during cooking. When drawer pauses, turn bacon over and touch START/+30 SEC. After cooking, let stand for 2 to 3 minutes. Different thickness of bacon cook differently. Monitor during cooking for desired level of crispness. For crispy baco, let the drawer run full cook cycle of 20 minutes. Speed Cook baking works well for thin and regular cuts of bacon. Never pour bacon grease in the sink. Allow grease to cool to room temperature and safely discard it.
<b>21</b> Chicken Drummies	1.0 - 2.5 lb (3 - 6 large drumsticks)	Convection Grill	Place the cook tray on the top rack in the lower position and begin preheating. Season drumsticks as desired and evenly space on top of cook tray after preheating the drawer. When drawer pauses, turn drumsticks over and touch START/+30 SEC. After cooking, let stand for 2 to 3 minutes. Convection grilling works well for marinated or plain drumsticks. Placing cook tray in the drawer during preheat allows for faster and more even cooking.
<b>22</b> Chicken Breast (Boneless)	1.0 - 3.5 lb (1 - 3 large breast pieces)	Convection Grill	Place the top rack in the lower position and begin preheating. Season the chicken breast pieces as desired and place on top of cook tray. Place cook tray on top of top rack after preheating the drawer. When drawer pauses, turn chicken over and touch START/+30 SEC. After cooking, let stand for 2 to 3 minutes. Convection grilling works well for skin-on or skinless chicken breasts. Placing rack in the drawer during preheat allows for faster and more even cooking.
<b>23</b> Whole Chicken	2.5 - 7.5 lb	Speed Cook Roast	Set cook tray in the drawer to use as a drip tray. Place the bottom rack in the lower position. Use the slider bar to select the weight and begin preheating. Season the chicken as desired and place directly on the rack after preheating the drawer. Use an instant read thermometer to ensure the internal temperature of the meat has reached 165°F.
<b>24</b> Turkey Breast	1.0 - 3.5 lb	Convection Roast	Place the top rack in the lower position. Use the slider bar to select the weight and begin preheating. Season turkey breast as desired and set on top of cook tray. Place cook tray on top of the bottom rack after preheating the drawer. Covering the turkey breast with foil and letting it stand after cooking allows the juices to redistribute, creating a moist interior while maintaining a crispy, browned exterior. Use an instant read thermometer to ensure the internal temperature of the meat has reached 165°F.

**CAUTION** The oven cabinet, cavity, door, tray, racks and dishes will become hot. To PREVENT BURNS, use thick oven gloves when removing the food from the oven.

During convection heating, hot air is circulated throughout the oven cavity to brown and crisp foods quickly and evenly. This oven can be programmed for ten different preset convection cooking temperatures for up to 2 hours.

## RECIPE CONVERSION

When using Convection cooking, adjust temperature and cook time to avoid overcooking.

**Temperature** - Reduce by 25°F

**Time** - Monitor foods regularly for doneness. Convection ovens cook more rapidly than conventional ovens.

## CONVECTION BAKE

BAKE	90°F - 450°F	2 hour max cook time	Cookies, cakes, biscuits, pizzas and chicken nuggets
BAKE PROOF (number 1 pad)	90°F	2 hour max cook time	Use for proofing bread doughs

## BAKE WITH PREHEAT

- 1 Touch BAKE/WARM pad once.
- 2 Touch 1 pad to preheat.
- 3 Select desired temperature by touching number pads 1-0. Ex: To bake at 450°F, touch the 0 pad.
- 4 Touch START/+30 SEC pad to begin preheating the oven.

An audible signal will sound 4 beeps to indicate that the preheat cycle is complete. Carefully open the drawer and set food inside of the oven.

**Note:** If the oven drawer is not opened within 20 minutes after preheating has completed, the oven will turn OFF automatically.

- 5 Enter desired cook time in HOURS and MINUTES by touching number pads. Ex: Touch 1 2 5 to bake for 1 hour and 25 minutes. Time will display as 1:25 H.

**IMPORTANT:** If you wish to change the time entry, simply touch the pads to enter new desired time WHILE TIME DISPLAY IS BLINKING on the oven. DO NOT TOUCH STOP/CLEAR. Touching STOP/CLEAR will cancel the Convection Cook cycle. If time is entered after STOP/CLEAR is touched, a microwave cycle will be initiated. This can be dangerous if non-microwave-safe cookware is being used.

- 6 Touch START/+30 SEC pad to begin cooking.

To adjust temperature before starting the cook cycle, touch BAKE/WARM again before touching START/+30 SEC,

### Note:

- The maximum cooking time available is 2 hours. If you enter a time above this duration, the following message will display: ERROR 2 HOUR MAX TIME TOUCH CLEAR.

- The oven displays cooking countdown in Hours and Minutes. Touch BAKE/WARM during the cooking cycle to view temperature.
- Time and temperature cannot be adjusted once cooking cycle has started. In order to modify time or temperature, touch STOP/CLEAR to cancel current settings and end cooking cycle.

## BAKE WITHOUT PREHEAT

- 1 Touch BAKE/WARM pad once.
- 2 Touch 2 pad to select no preheat.
- 3 Select desired temperature by touching number pads 2-0. Ex: To bake at 375°F, touch the 7 pad.
- 4 Enter desired cook time in HOURS and MINUTES by touching number pads. Ex: Touch 1 2 5 to bake for 1 hour and 25 minutes. Time will display as 1:25 H.

**IMPORTANT:** If you wish to change the time entry, simply touch the pads to enter new desired time WHILE TIME DISPLAY IS BLINKING on the oven. DO NOT TOUCH STOP/CLEAR. Touching STOP/CLEAR will cancel the Convection Cook cycle. If time is entered after STOP/CLEAR is touched, a microwave cycle will be initiated. This can be dangerous if non-microwave-safe cookware is being used.

- 5 Place food inside the oven. Touch START/+30 SEC pad to begin cooking.

To adjust temperature before starting the cook cycle, touch BAKE/WARM again before touching START/+30 SEC,

### Note:

- If the oven drawer is not opened within 10 minutes after the time entry has been selected, the oven will turn OFF automatically. The oven does not give instruction to open the drawer and set food inside, only to touch start.
- The maximum cooking time available is 2 hours. If you enter a time above this duration, the following message will display: ERROR 2 HOUR MAX TIME TOUCH CLEAR.
- The oven displays cooking countdown in Hours and Minutes. Touch BAKE/WARM during the cooking cycle to view temperature.
- Time and temperature cannot be adjusted once cooking cycle has started. In order to modify time or temperature, touch STOP/CLEAR to cancel current settings and end cooking cycle.

# CONVECTION COOKING - MANUAL

## BAKE PROOF BREADS

- 1 Touch and hold the BAKE/WARM pad for 3 seconds. WARM will display on the oven.
- 2 Touch 1 pad to proof at 90°F.
- 3 Enter desired time in HOURS and MINUTES by touching number pads. Ex: Touch 1 1 5 to proof dough for 1 hour and 15 minutes. Time will display as 1:15 H.

**IMPORTANT:** If you wish to change the time entry, simply touch the pads to enter new desired time WHILE TIME DISPLAY IS BLINKING on the oven. DO NOT TOUCH STOP/CLEAR. Touching STOP/CLEAR will cancel the Convection Cook cycle. If time is entered after STOP/CLEAR is touched, a microwave cycle will be initiated. This can be dangerous if non-microwave-safe cookware is being used.

- 4 Touch START/+30 SEC pad to begin cooking.

### Note:

- If the oven drawer is not opened within 10 minutes after the time entry has been selected, the oven will turn OFF automatically. The oven does not give instruction to open the drawer and set food inside, only to touch start.
- The maximum cooking time available is 2 hours. If you enter a time above this duration, the following message will display: ERROR 2 HOUR MAX TIME TOUCH CLEAR.
- Proof is also available as one of the Convection Warm functions. See page 29 for more details.

## CONVECTION ROAST

---

375°F - 450°F	2 hour max cook time	Turkey, poultry and pork
---------------	-------------------------	-----------------------------

---

### ROAST WITH PREHEAT

- 1 Touch ROAST pad once.
- 2 Touch 1 pad to select preheat.
- 3 Select desired temperature by touching number pads 7-0. Ex: To roast at 375°F, touch the 7 pad.
- 4 Touch START/+30 SEC pad to begin preheating the oven.

An audible signal will sound 4 beeps to indicate that the preheat cycle is complete. Carefully open the drawer and set food inside of the oven.

**Note:** If the oven drawer is not opened within 20 minutes after preheating has completed, the oven will turn OFF automatically.

- 5 Enter desired cook time in HOURS and MINUTES by touching number pads. Ex: Touch 2 0 0 to roast for 2 hours. Time will display as 2:00 H.

**IMPORTANT:** If you wish to change the time entry, simply touch the pads to enter new desired time WHILE TIME DISPLAY IS BLINKING on the oven. DO NOT TOUCH STOP/CLEAR. Touching STOP/CLEAR will cancel the Convection Cook cycle. If time is entered after STOP/CLEAR is touched, a microwave cycle will be initiated. This can be dangerous if non-microwave-safe cookware is being used.

- 6 Touch START/+30 SEC pad to begin cooking.

To adjust temperature before starting the cook cycle, touch ROAST again before touching START/+30 SEC.

### Note:

- The maximum cooking time available is 2 hours. If you enter a time above this duration, the following message will display: ERROR 2 HOUR MAX TIME TOUCH CLEAR.
- The oven displays cooking countdown in Hours and Minutes. Touch ROAST during the cooking cycle to view temperature.
- Time and temperature cannot be adjusted once cooking cycle has started. To modify time or temperature, touch STOP/CLEAR to cancel current settings and end cooking cycle.

### ROAST WITHOUT PREHEAT

- 1 Touch ROAST pad once.
- 2 Touch 2 pad to select no preheat.
- 3 Select desired temperature by touching number pads 7-0. Ex: To roast at 375°F, touch the 7 pad.
- 4 Enter desired cook time in HOURS and MINUTES by touching number pads. Ex: Touch 3 5 to roast for 35 minutes. Time will display as :35 H.

**IMPORTANT:** If you wish to change the time entry, simply touch the pads to enter new desired time WHILE TIME DISPLAY IS BLINKING on the oven. DO NOT TOUCH STOP/CLEAR. Touching STOP/CLEAR will cancel the Convection Cook cycle. If time is entered after STOP/CLEAR is touched, a microwave cycle will be initiated. This can be dangerous if non-microwave-safe cookware is being used.

- 5 Place food inside the oven. Touch START/+30 SEC pad to begin cooking.

To adjust temperature before starting the cook cycle, touch ROAST again before touching START/+30 SEC.

### Note:

- If the oven drawer is not opened within 10 minutes after the time entry has been selected, the oven will turn OFF automatically.
- The maximum cooking time available is 2 hours. If you enter a time above this duration, the following message will display: ERROR 2 HOUR MAX TIME TOUCH CLEAR.
- The oven does not give instruction to open the drawer and set food inside, only to touch start
- The oven displays cooking countdown in Hours and Minutes. Touch ROAST during the cooking cycle to view temperature.
- Time and temperature cannot be adjusted once cooking cycle has started. To modify time or temperature, touch STOP/CLEAR to cancel current settings and end cooking cycle.

## CONVECTION GRILL

450°F	30 minutes max cook time	Fish, vegetables, burgers and steaks
-------	-----------------------------	---

### GRILL WITH PREHEAT

- 1 Touch GRILL/TOAST pad once.
  - 2 Touch 1 pad to select preheat.
  - 3 Touch START/+30 SEC pad to begin preheating the oven.
- An audible signal will sound 4 beeps to indicate that the preheat cycle is complete. Carefully open the drawer and set food inside of the oven.

**Note:** If the oven drawer is not opened within 20 minutes after preheating has completed, the oven will turn OFF automatically.

- 4 Enter desired cook time in MINUTES by touching number pads. Ex: Touch 2 0 to grill for 20 minutes. Time will display as :20 H.

**IMPORTANT:** If you wish to change the time entry, simply touch the pads to enter new desired time WHILE TIME DISPLAY IS BLINKING on the oven. DO NOT TOUCH STOP/CLEAR. Touching STOP/CLEAR will cancel the Convection Cook cycle. If time is entered after STOP/CLEAR is touched, a microwave cycle will be initiated. This can be dangerous if non-microwave-safe cookware is being used.

- 5 Touch START/+30 SEC pad to begin cooking.

#### Note:

- The maximum cooking time available is 30 minutes. If you enter a time above this duration, the following message will display: ERROR 30 MINUTES MAX TIME TOUCH CLEAR.
- The oven displays cooking countdown in Minutes. Touch GRILL/TOAST during the cooking cycle to view temperature.
- Time cannot be adjusted once cooking cycle has started. To modify time, touch STOP/CLEAR to cancel current settings and end cooking cycle.

### GRILL WITHOUT PREHEAT

- 1 Touch GRILL/TOAST pad once.
- 2 Touch 2 pad to select no preheat.
- 3 Enter desired cook time in MINUTES by touching number pads. Ex: Touch 2 0 to grill for 20 minutes. Time will display as :20 H.

**IMPORTANT:** If you wish to change the time entry, simply touch the pads to enter new desired time WHILE TIME DISPLAY IS BLINKING on the oven. DO NOT TOUCH STOP/CLEAR. Touching STOP/CLEAR will cancel the Convection Cook cycle. If time is entered after STOP/CLEAR is touched, a microwave cycle will be initiated. This can be dangerous if non-microwave-safe cookware is being used.

- 4 Place food inside the oven. Touch START/+30 SEC pad to begin cooking.

#### Note:

- If the oven drawer is not opened within 10 minutes after the time entry has been selected, the oven will turn OFF automatically. The oven does not give instruction to open the drawer and set food inside, only to touch start.
- The oven displays cooking countdown in Minutes. Touch GRILL/TOAST during the cooking cycle to view temperature.
- Time cannot be adjusted once cooking cycle has started. To modify time, touch STOP/CLEAR to cancel current settings and end cooking cycle.

## CONVECTION WARM

Proof bread doughs and keep cooked food warm for up to 4 hours while preserving texture and flavor to deliver meals that taste fresh-from-the-oven. There is no preheat with WARM.

Dishes should be covered to retain moisture. Plastic wrap, foil and glass lids are recommended. See ABOUT UTENSILS AND COVERINGS section for details.

### 90°F - 200°F

[1] 90°F	Proofing dough and warming plates
[2] 150°F	Warming roasts, pastries, breads, quiches and vegetable casserole dishes
[3] 200°F	Warming poultry, pork, mashed potatoes, dense casseroles, e.g., lasagna

- 1 Touch and hold the BAKE/WARM pad for 3 seconds. WARM will display on the oven.
- 2 See Menu Label. Make selection by touching number pads 1-3. To change temperature, touch STOP/CLEAR to begin again.
- 3 Enter desired time in HOURS and MINUTES by touching number pads. Ex: Touch 3 3 0 to warm for 3 hours and 30 minutes. Time will display as 3:30 H.

**IMPORTANT:** If you wish to change the time entry, simply touch the pads to enter new desired time WHILE TIME DISPLAY IS BLINKING on the oven. DO NOT TOUCH STOP/CLEAR. Touching STOP/CLEAR will cancel the Convection Cook cycle. If time is entered after STOP/CLEAR is touched, a microwave cycle will be initiated. This can be dangerous if non-microwave-safe cookware is being used.

- 4 Place food inside the oven. Touch START/+30 SEC pad to begin warming.

#### Note:

- The maximum warming time available is 4 hours. If you enter a time above this duration, the following message will display: ERROR 4 HOURS MAX TIME TOUCH CLEAR.
- Touch BAKE/WARM during the cooking cycle to view temperature (once cooking has started, it is not necessary to hold the pad for 3 seconds).

# CONVECTION COOKING - MANUAL

## CONVECTION TOAST

Toast breads and bagels perfectly by selecting desired level of browning with pre-timed options. There is no preheat with TOAST. Temperature: 450°F.

TOAST: 1 - 4 pieces

Presets:	[1] Light	[4] Medium dark
	[2] Medium light	[5] Dark
	[3] Medium	

- 1 Touch and hold the GRILL/TOAST pad for 3 seconds. TOAST will display on the oven.
- 2 See Menu Label. Make selection by touching number pads 1-5. Ex: Touch 3 to select Medium browning. Place food inside the oven.
- 3 Touch START/+30 SEC to begin cooking. Time will display as : 05 H.
- 4 Halfway through cooking time, open the oven and flip food.

### Note:

- To change desired level of browning, touch STOP/CLEAR to begin again.
- Touch GRILL/TOAST during the cooking cycle to view selected browning level (once cooking has started, it is not necessary to hold the pad for 3 seconds).

## CONVECTION AIR FRY

AIR FRY uses convection fans to cook foods with moist, soft interiors and perfectly crisped exteriors without using cooking oil. There are many reasons to use your Convection Microwave Drawer to air fry foods.

**Convenience.** Using your Convection Microwave Drawer for your air fry needs saves you from needing another appliance.

**Easy Clean-up.** All you need to clean in the Convection Microwave Drawer is the rack the food is cooked on.

**Large Batch Cooking.** You'll be able to cook large batches that would otherwise take several small batches in a traditional air fryer.

**Viewing Window.** The Convection Microwave Drawer has a viewing window through which you can monitor your food cooking.

There are four preset selections of convenience foods to cook with AIR FRY.

- 1 Touch AIR FRY pad once.
- 2 See Menu Label. Make selection by touching number pads 1-4. To change menu item, touch STOP/CLEAR to begin again.
- 3 Touch START/+30 SEC pad to preheat the oven. An audible signal will sound 4 beeps to indicate that the preheat cycle is complete. The estimated preheat time for all preset air fry foods is 10–13 minutes.
- 4 Carefully open the drawer and set food inside of the oven and touch START/+30 SEC pad to begin cooking.

### Notes:

- If the oven drawer is not opened within 20 minutes after preheating has completed, the oven will turn OFF automatically.
- **Because of the larger oven capacity, the preheat time and cook times could be slightly longer than the common air fryers.**

## AIR FRY CHART

Estimate Preheat Time 10-13 minutes

SETTING/ FOOD	AMOUNT	COOK TIME	PROCEDURE
1 Chicken Tenders	3 - 8 pieces	18 minutes	Place a crisper or sheet tray on the top rack in the lower position and begin preheating. Evenly space 3 to 8 chicken tenders on top of the tray after preheating the drawer. Leave space between pieces to allow for crisping. For crispier texture, use a crisping pan instead of sheet tray. If using crisper pan, place the cook tray in the bottom of the drawer to use as a drip tray for easy clean-up.
2 French Fries	10 - 24 oz	23 minutes	Place a crisper or sheet tray on the top rack in the lower position and begin preheating. Evenly space french fries on top of the tray after preheating the drawer. Leave space between pieces to allow for crisping. French fry brands and sizes vary. See package instructions. Curly and waffle fries may require additional cooking time while shoestring fries will require less. Monitor cooking in progress. For crispier texture, use a crisping pan instead of sheet tray. If using crisper pan, place the cook tray in the bottom of the drawer to use as a drip tray for easy clean-up.
3 Mozzarella Sticks	4 - 12 pieces	12 minutes	Place a crisper or sheet tray on the top rack in the lower position and begin preheating. Evenly space 4 to 12 mozzarella sticks on top of the tray after preheating the drawer. Leave space between pieces to allow for crisping. For crispier texture, use a crisping pan instead of sheet tray. If using crisper pan, place the cook tray in the bottom of the drawer to use as a drip tray for easy clean-up. Use Microwave mode to heat dipping sauce in a microwave-safe dish.
4 Tater Tots	10 - 24 oz	18 minutes	Place a crisper or sheet tray on the top rack in the lower position and begin preheating. Evenly space tater tots on top of the tray after preheating the drawer. Leave space between pieces to allow for crisping. For crispier texture, use a crisping pan instead of sheet tray. If using crisper pan, place the cook tray in the bottom of the drawer to use as a drip tray for easy clean-up.

## SPEED COOK – MICROWAVE & CONVECTION COMBINATION

The oven has three pre-programmed combination cook modes to cook with convection and microwave automatically.

**IMPORTANT:** Always use microwave-safe and oven-safe cookware when using Speed Cook functions as the oven combines microwave and conventional oven power. See ABOUT UTENSILS AND COVERINGS pages 10-11.

**Speed Cook** provides great results for most items that do not require conventional oven methods.

The combination of microwave power with convection heat decreases cooking time while producing moist and juicy interiors and perfectly browned and crisped exteriors.

- **Speed Bake** is recommended for delicate items such as cake, breads and fish.
- **Speed Roast** works wonderfully for dense meats, larger pieces of poultry, beef and pork.
- **Speed Grill** is ideal for burgers, chicken drumsticks and thick pork chops.

The temperatures for Speed Bake and Speed Roast may be adjusted. The temperature for Speed Grill is preset at 450°F. Microwave power levels for Speed Bake, Speed Roast and Speed Grill are preset.

For instructions on rack and tray placement, see ACCESSORIES on page 14 for details.

	OVEN TEMP.	MICROWAVE POWER	COOK TIME MAX.
1 Speed Bake	Auto Set for 350°F Adjustable from 90°F - 450°F	20%	2 hours
2 Speed Roast	Auto Set for 425°F Adjustable from 375°F - 450°F	30%	2 hours
3 Speed Grill	450°F	20%	30 minutes

### SPEED COOK WITH PREHEAT

- 1 Touch SPEED COOK pad once.
- 2 See Menu Label. To select modes: Bake, Roast or Grill, touch number pads 1-3. Ex: Touch 3 to cook with SPEED GRILL.
- 3 Touch 1 pad to select preheat.
- 4 Touch START/+30 SEC pad to begin preheating the oven.

An audible signal will sound 4 beeps to indicate that the preheat cycle is complete. Carefully open the drawer and set food inside of the oven.

**Note:** If the oven drawer is not opened within 20 minutes after preheating has completed, the oven will turn OFF automatically.

- 5 Enter desired time in MINUTES by touching the number pads. Ex: Touch 2 0 to grill for 20 minutes. Time will display as :20 H.

**IMPORTANT:** If you wish to change the time entry, simply touch the pads to enter new desired time WHILE TIME DISPLAY IS BLINKING on the oven. DO NOT TOUCH

STOP/CLEAR. Touching STOP/CLEAR will cancel the Convection Cook cycle. If time is entered after STOP/CLEAR is touched, a microwave cycle will be initiated. This can be dangerous if non-microwave-safe cookware is being used.

- 6 Touch START/+30 SEC pad to begin cooking.

#### Note:

- Refer to the chart at the left to view maximum cooking times available. An error message will display if a time above the maximum cook time allowed is entered.
- Touch SPEED COOK to view oven temperature and microwave power.
- Time cannot be adjusted once cooking cycle has started. To modify time, touch STOP/CLEAR to cancel current settings and end cooking cycle.

### SPEED COOK WITHOUT PREHEAT

- 1 Touch SPEED COOK pad once.
- 2 See Menu Label. To select modes: Bake, Roast or Grill, touch number pads 1-3. Ex: Touch 1 to cook with SPEED BAKE.
- 3 Touch 2 pad to select no preheat.
- 4 Enter desired time in HOURS and MINUTES by touching the number pads. Ex: Touch 3 0 to bake for 30 minutes. Time will display as :30 H.

**IMPORTANT:** If you wish to change the time entry, simply touch the pads to enter new desired time WHILE TIME DISPLAY IS BLINKING on the oven. DO NOT TOUCH STOP/CLEAR. Touching STOP/CLEAR will cancel the Convection Cook cycle. If time is entered after STOP/CLEAR is touched, a microwave cycle will be initiated. This can be dangerous if non-microwave-safe cookware is being used.

- 5 Place food inside the oven. Touch START/+30 SEC pad to begin cooking at the preset temperature of 350°F.

To adjust temperature before starting, touch BAKE/WARM again before touching START/+30 SEC to begin the cook cycle. Ex: To change the temperature, touch BAKE/WARM then touch 3 to change temperature to 275°F. Then, touch START/+30 SEC to begin cooking or touch another temperature using pads 2-0 to select a different temperature.

#### Note:

- If the oven drawer is not opened within 10 minutes after the time entry has been selected, the oven will turn OFF automatically. The oven does not give instruction to open the drawer and set food inside, only to touch start
- Refer to the chart at the left to view maximum cooking times available. An error message will display if a time above the maximum cook time allowed is entered.
- Touch SPEED COOK to view oven temperature and microwave power.
- Time and temperature cannot be adjusted once cooking cycle has started. In order to modify time or temperature, touch STOP/CLEAR to cancel current settings and end cooking cycle.

## OTHER FEATURES

### TIMER/SETTINGS

If the electrical power supply to your Convection Microwave Drawer should be interrupted, the display will intermittently show ENJOY YOUR OVEN TOUCH CLEAR after the power is reinstated. If this occurs, the SETTINGS option you input will be erased. Simply touch STOP/CLEAR pad and reset.

#### TIMER

- 1 Touch TIMER/SETTINGS pad 2 times.
- 2 Enter time.
- 3 Touch START/+30 SEC pad.

To cancel timer, touch STOP/CLEAR.

#### AUDIBLE SIGNAL ELIMINATION

At the end of timed cook, beeps will sound. The audible signal can be turned off if you prefer quiet operation.

#### TO TURN SOUND OFF

- 1 Touch TIMER/SETTINGS pad 8 times.
- 2 Touch START/+30 SEC pad. The display shows SOUND OFF.

#### TO RESTORE SOUND

- 1 Touch TIMER/SETTINGS pad 8 times.
- 2 Touch START/+30 SEC pad. The display shows SOUND ON.

#### END OF COOKING REMINDER

At end of timed cooking, the microwave will signal every 10 seconds for the first minute, and then every 3 minutes for up to one hour until STOP/CLEAR pad is touched.

#### TO TURN REMINDER OFF

- 1 Touch TIMER/SETTINGS pad 9 times. The display shows REMIND SIGNAL OFF? TOUCH START.
- 2 Touch START/+30 SEC pad. The display shows REMIND SIGNAL OFF.

#### TO TURN REMINDER SIGNAL BACK ON

- 1 Touch TIMER/SETTINGS pad 9 times. The display shows REMIND SIGNAL ON? TOUCH START.
- 2 Touch START/+30 SEC pad. The display shows REMIND SIGNAL ON.

#### AUTO START

If you wish to program the Convection Microwave Drawer to begin cooking automatically at a designated time of day, follow this procedure.

- 1 Touch TIMER/SETTINGS pad 10 times. The display shows AUTO START TOUCH START.
- 2 Touch START/+30 SEC pad.
- 3 Enter start time.
- 4 Touch TIMER/SETTINGS pad.

- 5 Touch the number pads to enter cooking time. Touch POWER LEVEL pad repeatedly until the desired power level is reached.

- 6 Touch START/+30 SEC pad.

### DEMONSTRATION MODE

#### TO SELECT DEMO MODE

- 1 Touch TIMER/SETTINGS pad 11 times. The display shows DEMO ON? HOLD START 3 SEC.
- 2 Hold START/+30 SEC pad for 3 seconds. The display shows DEMO ON.

#### TO CANCEL DEMO MODE

- 1 Touch TIMER/SETTINGS pad 11 times. The display shows DEMO OFF? TOUCH START.
- 2 Touch START/+30 SEC pad. The display shows DEMO OFF.

#### Note:

- Convection Microwave Drawer doesn't heat in Demo Mode.
- Display counts down quickly.

### +30 SEC

#### (ADDITIONAL TIME FOR MICROWAVE COOKING)

+30 SEC may be used to add additional time by touching the START/+30 SEC pad on the oven or the +30 SEC button in the app. On the oven, touch the START/+30 SEC pad to cook for 30 seconds at 100% power. Cooking time can also be extended in multiples of 30 seconds by repeatedly touching the START/+30 SEC pad.

- To use +30 SEC, touch pad within 3 minutes after cooking completion, after closing the drawer, or after touching the STOP/CLEAR pad once.
- If the STOP/CLEAR pad is touched twice prior to the end of cooking, +30 SEC cannot be activated until the drawer has been opened and then closed.
- SENSOR, DEFROST and MORE MENU: Additional time may be added only after the cooking cycle has completed by touching the START/+30 SEC pad on the oven or the +30 SEC button in the app.
- MANUAL: Additional time may be added during the cooking cycle as well as after cooking has completed if used within 3 minutes of cooking completion.

If using the app, SENSOR, DEFROST and MORE MENU items are found under MICROWAVE SMART COOK menu page.

If using the app, MICROWAVE MANUAL menu is found under the CONVECTION MANUAL COOK menu page.



### +2 MIN

#### (ADDITIONAL TIME FOR CONVECTION COOKING - APP ONLY)

+2 MIN is an **APP ONLY** feature that may be used to add additional time to convection cooking.

- To use +2 MIN, touch the button within 3 minutes after cooking completion, after closing the drawer or after touching the STOP/CLEAR pad once.
- If the STOP/CLEAR pad is touched twice prior to the end of cooking, +2 MIN cannot be activated until the drawer has been opened and then closed.
- **CONVECTION MORE MENUS:** Additional time may be added only after the cooking cycle has completed by touching the +2 MIN button on the app.
  - If using the app, MORE MENU items are found under CONVECTION SMART COOK menu page.
- **MANUAL:** Additional time may be added during the cooking cycle as well as after cooking has completed, if used within 3 minutes of cooking completion.
  - If using the app, the MANUAL COOK menu provides BAKE/WARM, ROAST, GRILL/TOAST, SPEED COOK and AIR FRY.

**Note:** TOAST Time can be extended +1 MIN only after cooking has completed if the button is touched within 3 minutes of cooking completion.

### CONTROL LOCK

The Control Lock prevents unwanted drawer operation such as by small children. The Convection Microwave Drawer can be set so that the control panel and the automatic drawer mechanism are deactivated or locked.

#### TO LOCK

Touch STOP/CLEAR pad and hold for 3 seconds. The display shows LOCK ON.

#### TO UNLOCK

Touch STOP/CLEAR pad and hold for 3 seconds. The display shows LOCK OFF.

The Control Lock is canceled when the electrical power supply to your oven is interrupted. Set the Control Lock again when power to the oven is restored.

### MICROWAVE MULTIPLE SEQUENCE COOKING

Microwave cooking can be programmed for up to 4 automatic cooking sequences, switching from one power level setting to another automatically.

Sometimes cooking directions tell you to start on one power level and then change to a different power level. Your Convection Microwave Drawer can do this automatically.

- 1** First enter cooking time. Then touch POWER LEVEL pad once for 100% cooking or repeatedly touching POWER LEVEL pad for a lower power level.
- 2** Enter second cooking time. Repeat touching POWER LEVEL pad for desired level. You can follow this procedure up to 4 times.
- 3** Touch START/+30 SEC pad.

#### Note:

- If POWER LEVEL pad is touched once, HIGH will be displayed.
- If 100% is selected as the final sequence, it is not necessary to touch the POWER LEVEL pad.
- If you wish to know power level during cooking, simply touch the POWER LEVEL pad. As long as your finger is touching the POWER LEVEL pad, the power level will be displayed.

**Note:** Multiple sequence cooking is not available for use with convection cooking mode.

### MORE OR LESS TIME ADJUSTMENT

Should you discover that you like any of the REHEAT or DEFROST settings slightly more done, touch the POWER LEVEL pad once after touching your selection. The display will show MORE.

For slightly less done, touch the POWER LEVEL pad twice after touching your selection. The display will show LESS.

### STANDBY MODE

This Convection Microwave Drawer will go into standby mode after a period of inactivity. The backlight of the display will automatically dim after 3 minutes if the unit has not been in operation. If the display is in standby mode, simply touch the control panel or open/close the door to return the backlight to maximum brightness.

### HELP

Each setting of Popcorn, Reheat, Cook, Defrost and Beverage has a cooking hint. If you wish to check, touch TIMER/SETTINGS whenever HELP is lighted in the Interactive Display for these and other manual operation hints.

## OTHER FEATURES

### INDICATORS LENS AND COLOR LEGEND

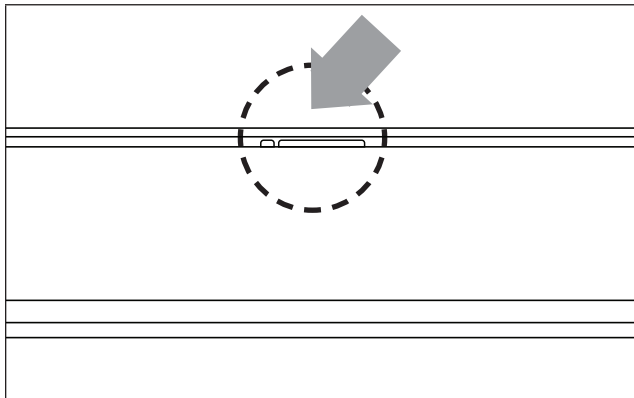

WI-FI STATUS	OVEN STATUS	COMMENTS
Wi-Fi Off	Wave Open Off	Oven on Standby (out of the box)
Wi-Fi On - blue light	Wave Open Off	Oven on Standby - Not Cooking
Wi-Fi Off	Wave Open On - white light	Oven on Standby - Not Cooking
Wi-Fi On - blue light	Wave Open On - white light	Oven on Standby - Not Cooking
Wi-Fi On - blue light	Cooking - green light	Microwave - Slow Flash - Sensor/On Full - Count Down
Wi-Fi On - blue light	Cooking - magenta light	Convection - Slow Flash - Preheat/On Full - Count Down
Wi-Fi On - blue light	Cooking - red light	Slow Flash - Stopped, Ready to Open
Wi-Fi On - blue light	Cooking - yellow light	Slow Flash - Time is Paused
Wi-Fi On - blue light	Remote Start Active - white light	Flash every 5 second - Drawer opened, 3 minute window to remote operate App/Alexa (Microwave Mode Only)

- **ENSURE THE CONVECTION MICROWAVE DRAWER IS OFF BEFORE CLEANING TO PREVENT BURNS.**
- **NEVER USE HARSH, ABRASIVE OR COMMERCIAL GRADE CLEANERS ON ANY PART OF THE OVEN.**

### EXTERIOR

The outside surface is precoated metal and glass. Clean the outside with mild soap and water. Rinse and dry with a soft cloth. Do not use any type of household or abrasive cleaner.

### STAINLESS STEEL SURFACE

The exterior should be wiped often with a soft damp cloth and polished with a soft dry cloth to maintain its beauty. There are also a variety of products designed especially for cleaning and shining the stainless exterior of the oven. We recommend that the cleaner be applied to a soft cloth and then carefully used on the stainless exterior rather than sprayed directly on to it. Follow package directions carefully.

### FRONT SIDE OF THE DRAWER

Wipe the window on both sides with a soft damp cloth to remove any spills or spatters. Metal parts will be easier to maintain if wiped frequently with a soft damp cloth. Avoid the use of spray and other harsh cleaners as they may stain, streak or dull the drawer surface.

### TOUCH CONTROL PANEL

If desired, the touch pads may be deactivated before cleaning. See the Control Lock information on page 33 of this manual. Wipe the panel with a cloth dampened slightly with water only. Dry with a soft cloth. Do not scrub or use any sort of chemical cleaners. Close drawer and follow directions on page 33 for turning Control Lock off. Touch STOP/CLEAR.

### INTERIOR

Before cleaning the Convection Microwave Drawer, touch and hold the STOP/CLEAR button for 3 seconds to lock the control pad and the automatic door mechanism. The drawer can be locked in either the open or closed position. The display will show LOCK ON. This will prevent the drawer from accidentally opening or closing during cleaning. After cleaning, touch and hold the STOP/CLEAR button for 3 seconds to turn the lock off. The display will show LOCK OFF. Keep the interior of the oven clean and free of any food particles or liquid spills that can build up on the oven walls, decreasing the cooking efficiency of the appliance.

Never use a metal scouring pad or recycled paper towels that may flake off and leave metal particles inside the cavity.

### INTERIOR - AFTER MICROWAVE COOKING

Cleaning is easy because no heat is generated to the interior surfaces, so there is no baking and setting of spills or spattering. To clean the interior surfaces, including drawer sealing surfaces, wipe with a soft damp cloth. **DO NOT USE ABRASIVE OR HARSH CLEANERS OR SCOURING PADS.** For heavier soil, use mild soap and wipe clean with a soft damp cloth. Do not use any chemical oven cleaners.

### INTERIOR - AFTER CONVECTION, ROAST, GRILL, SPEED COOK OR AIR FRY

Spatters may occur because of moisture and grease. Wash immediately after use with hot, soapy water.

Rinse and polish dry. Harder to remove spatters may occur if oven is not thoroughly cleaned or if there is long time/high temperature cooking.

After cleaning the interior thoroughly, residual grease may be removed from the interior ducts and heater by simply operating the oven on 450°F for 20 minutes without food. Ventilate the room if necessary.

### CONVECTION MICROWAVE DRAWER GUIDES

Remove the food crumbs from the Convection Microwave Drawer guides. Wipe with a soft dry cloth in order to keep the Convection Microwave Drawer opening and closing smoothly.

### ODOR REMOVAL USING MICROWAVE POWER

Occasionally, a cooking odor may remain in the oven. To remove, combine 1 cup water, grated peel and juice of 1 lemon and several whole cloves in a 2-cup glass measuring cup. Boil for several minutes using 100% power. Allow to set in microwave oven until cool. Wipe interior with a soft cloth.

**Note:** Do not use the Microwave power if the cavity is empty, as the microwaves will not be absorbed, increasing risk of fire in the cavity.

### TOP AND BOTTOM RACKS/TRAY

The racks and tray can be removed for easy cleaning. Wash them in mild, sudsy water. For stubborn stains, use a mild cleanser and a non-abrasive scouring sponge. The racks are dishwasher safe. The racks may be washed in either the upper or lower section of the dishwasher, and the tray may be washed in the lower section. Do not use a self-cleaning oven to clean the racks or tray.

## BEFORE YOU CALL FOR SERVICE

Please check the following before calling for service. It may save you time and expense.

PROBLEM	POSSIBLE CAUSE	SOLUTION
<b>1</b> Part or all of Convection Microwave Drawer does not operate.	<ul style="list-style-type: none"> <li>Power cord of Convection Microwave Drawer is not completely connected to the electrical outlet.</li> <li>Power outage.</li> <li>Fuse/circuit breaker at home doesn't work.</li> <li>Convection Microwave Drawer is in Demo Mode.</li> </ul>	<ul style="list-style-type: none"> <li>Make sure the power cord is tightly connected to the outlet.</li> <li>Check house lights to be sure. Call your local electric company for service.</li> <li>Replace the fuse or reset the circuit breaker.</li> <li>See page 32 for how to cancel Demo Mode.</li> </ul>
<b>2</b> Food in Convection Microwave Drawer is not heated.	<ul style="list-style-type: none"> <li>No power to the appliance.</li> <li>Drawer controls improperly set.</li> <li>Drawer is in Demo Mode.</li> </ul>	<ul style="list-style-type: none"> <li>See SOLUTION for PROBLEM 1.</li> <li>Check if the controls have been properly set.</li> <li>See page 32.</li> </ul>
<b>3</b> Convection Microwave Drawer light does not work.	<ul style="list-style-type: none"> <li>Light bulb is loose or burned out.</li> </ul>	<ul style="list-style-type: none"> <li>Call for service.</li> </ul>
<b>4</b> Touch controls will not operate.	<ul style="list-style-type: none"> <li>Control Lock is on.</li> </ul>	<ul style="list-style-type: none"> <li>See page 33 to unlock.</li> </ul>
<b>5</b> Display flashes.	<ul style="list-style-type: none"> <li>Power failure.</li> </ul>	<ul style="list-style-type: none"> <li>Touch STOP/CLEAR pad and reset the clock. If the Convection Microwave Drawer was in use, you must reset the cooking function.</li> </ul>
<b>6</b> Steam from the vent.	<ul style="list-style-type: none"> <li>During microwaving, water vapor may come from the left side of the vent (when facing the microwave).</li> </ul>	
<b>7</b> Fan noise.	<ul style="list-style-type: none"> <li>After using Convection or Speed Cook, you will hear the sound of the cooling fan. The fan may continue to operate for an extended period of time, depending on the oven temperature.</li> </ul>	<ul style="list-style-type: none"> <li>Once the oven has been properly cooled, the fan will turn off.</li> </ul>

For more complete information and safety precautions, refer to your Operation Manual.

## CONVECTION COOKING

### MORE MENUS (CONVECTION)

#### CONVECTION - BAKE, ROAST, GRILL

- 1 Touch the MORE MENU pad.
- 2 See Menu Label. Make selection by touching number pad.  
Ex: Touch 1 for biscuits.
- 3 Touch START/+30 SEC pad to begin preheating.  
After the preheat cycle ends, an audible signal will sound 4 beeps to indicate the preheat cycle is complete. Open the drawer to place food inside the oven.
- 4 Touch START/+30 SEC pad to begin cooking.

#### CONVECTION BAKE OR ROAST

##### WITH PREHEAT

- 1 Touch desired function (BAKE or ROAST) pad once.
- 2 Touch 1 pad to preheat.
- 3 Select desired temperature by using the number pads (2-0 for Bake, 7-0 for ROAST).
- 4 Touch START/+30 SEC pad to begin preheating the oven.  
After the preheat cycle ends, an audible signal will sound 4 beeps to indicate the preheat cycle is complete. Open the drawer to place food inside the oven.
- 5 Enter desired cook time in HOURS and MINUTES by using number pads.
- 6 Touch START/+30 SEC pad

##### WITHOUT PREHEAT

- 1 Touch desired function (BAKE or ROAST) pad once.
- 2 Touch 2 pad to select no preheat.
- 3 Select desired temperature by using the number pads (2-0 for Bake, 7-0 for ROAST).
- 4 Enter desired cook time in HOURS and MINUTES by using number pads.
- 5 Touch START/+30 SEC pad.

#### CONVECTION GRILL

##### WITH PREHEAT

- 1 Touch GRILL pad once.
- 2 Touch 1 pad to preheat.
- 3 Touch START/+30 SEC pad to begin preheating the oven.  
After the preheat cycle ends, an audible signal will sound 4 beeps to indicate the preheat cycle is complete. Open the drawer to place food inside the oven.
- 4 Enter desired cook time in MINUTES by using number pads.
- 5 Touch START/+30 SEC pad.

##### WITHOUT PREHEAT

- 1 Touch GRILL pad once.
- 2 Touch 2 pad to select no preheat.
- 3 Enter desired cook time in MINUTES by using number pads.
- 4 Touch START/+30 SEC pad.

#### BAKE PROOF BREADS

- 1 Touch and hold BAKE/WARM pad for 3 seconds.
- 2 Touch 1 pad to proof at 90°F.
- 3 Enter desired cook time in HOURS and MINUTES by using number pads.
- 4 Touch START/+30 SEC pad.

#### CONVECTION WARM

- 1 Touch and hold the BAKE/WARM pad for 3 seconds.
- 2 Select desired temperature by using number pads 1-3.
- 3 Enter desired cook time in HOURS and MINUTES by using number pads.
- 4 Touch START/+30 SEC pad.

#### CONVECTION TOAST

Touch & hold GRILL/TOAST pad for 3 seconds. Toast 1-4 pieces. Select from menu below:

- 1 Light
- 2 Medium light
- 3 Medium
- 4 Medium dark
- 5 Dark

#### CONVECTION AIR FRY

- 1 Touch AIR FRY pad once.
- 2 Select desired preset food item by using number pads 1-4.
- 3 Touch START/+30 SEC pad.

#### SPEED COOK

##### WITH PREHEAT

- 1 Touch SPEED COOK pad once.
- 2 Select modes by using number pads 1-3: Bake, Roast or Grill.
- 3 Touch 1 pad to select preheat.
- 4 Touch START/+30 SEC pad to begin preheating the oven.  
An audible signal will sound 4 beeps to indicate that the preheat cycle is complete. Carefully open the drawer and set food inside of the oven.
- 5 Enter desired time in HOURS and MINUTES by using number pads.
- 6 Touch START/+30 SEC pad.

##### WITHOUT PREHEAT

- 1 Touch SPEED COOK pad once.
- 2 Select modes by using number pads 1-3: Bake, Roast or Grill.
- 3 Touch 2 pad to select no preheat.
- 4 Enter desired time in HOURS and MINUTES by using number pads.
- 5 Touch START/+30 SEC pad

# AUTO-TOUCH GUIDE

For more complete information and safety precautions, refer to your Operation Manual.

## MICROWAVE COOKING

<p><b>TIME COOKING</b></p> <p><b>HIGH POWER COOKING</b></p> <ol style="list-style-type: none"> <li>1 Enter cooking time by touching number pads.</li> <li>2 Touch START/+30 SEC pad.</li> </ol> <p><b>VARIABLE POWER COOKING</b></p> <ol style="list-style-type: none"> <li>1 Enter cooking time by touching number pads.</li> <li>2 Touch POWER LEVEL pad until desired power level is in the display.</li> <li>3 Touch START/+30 SEC pad.</li> </ol>
<p><b>SENSOR (POPCORN, REHEAT, COOK)</b></p> <p>Sensor automatically computes the correct time and power level to cook foods on the Menu Label perfectly.</p> <ol style="list-style-type: none"> <li>1 Touch Cook pad once.</li> <li>2 See Menu Label. Select desired food by touching number pad. Ex: Touch 1 for baked potatoes.</li> <li>3 Touch START/+30 SEC pad.</li> </ol>
<p><b>DEFROST</b></p> <p>Use this feature to defrost the foods shown on the Menu Label.</p> <ol style="list-style-type: none"> <li>1 Touch DEFROST pad.</li> <li>2 See Menu Label. Select desired food by touching the number pad. Ex: Touch 2 for steaks/chops.</li> <li>3 Enter weight by touching number pads.</li> <li>4 Touch START/+30 SEC pad.</li> <li>5 After the first stage, open the Convection Microwave Drawer to turn steak over. Close the Convection Microwave Drawer. Touch START/+30 SEC pad.</li> <li>6 After each audible signal, turn food over and select START/+30 SEC again.</li> </ol>
<p><b>MORE MENUS (MELT / SOFT / WARM)</b></p> <p>Use these features to melt, soften or warm the foods shown on the Menu Label.</p> <ol style="list-style-type: none"> <li>1 Touch MORE MENUS pad once.</li> <li>2 See Menu Label. Select desired food by touching number pad. Ex: Touch 2 for chocolate.</li> <li>3 Repeat touching same number pad to select quantity. Ex: Touch 2 two more times for 1 square.</li> <li>4 Touch START/+30 SEC pad.</li> </ol>
<p><b>BEVERAGE REHEAT / HOT WATER / HOT CEREAL</b></p> <p>Use this feature for coffee, tea or hot cereal to reheat.</p> <ol style="list-style-type: none"> <li>1 Touch MORE MENUS pad once.</li> <li>2 See Menu Label. Make selection by touching number pad. Ex: Touch 8 to make coffee.</li> <li>3 Repeating touching same number pad to select quantity. Ex: Touch 8 two more times for 2 cups of coffee.</li> <li>4 Touch START/+30 SEC pad.</li> </ol>

## OTHER FEATURES

<p><b>TO SET THE CLOCK</b></p> <ol style="list-style-type: none"> <li>1 Touch TIMER/SETTINGS pad once.</li> <li>2 Touch number pads for correct time of day, touch START/+30 SEC.</li> </ol> <p>If the electrical power supply to your Convection Microwave Drawer should be interrupted, the display will intermittently show ENJOY YOUR OVEN TOUCH CLEAR after the power is reinstated.</p>
<p><b>+30 SEC</b></p> <p>Touch START/+30 SEC for 30 seconds at 100% microwave power or to add 30 seconds during manual cooking. Continue to touch for additional 30 seconds.</p>
<p><b>+2 MIN</b></p> <p><b>APP ONLY</b></p> <p>Touch +2 MIN in the Sharp Kitchen app to add two minutes during manual cooking or within 3 minutes of completion of convection cooking cycle.</p>
<p><b>TIMER/SETTINGS</b></p> <p>Touch TIMER/SETTINGS pad.</p> <ol style="list-style-type: none"> <li>1 time for Clock.</li> <li>2 times for Timer.</li> <li>3 times for Remote Start.</li> <li>4 times for Pairing.</li> <li>5 times for Wi-Fi Information.</li> <li>6 times for Wi-Fi Firmware Update.</li> <li>7 times for Wi-Fi Reset.</li> <li>8 times for Sound On/Off.</li> <li>9 times for End of Cooking Reminder On/Off.</li> <li>10 times for Auto Start.</li> <li>11 times for Demo Mode On/Off.</li> </ol>
<p><b>CONTROL LOCK</b></p> <p>The Control Lock prevents unwanted drawer operation such as by small children. The Convection Microwave Drawer can be set so that the control panel and the automatic drawer mechanism are deactivated or locked.</p> <p><b>TO LOCK</b></p> <p>Touch STOP/CLEAR pad and hold for 3 seconds. The display shows LOCK ON.</p> <p><b>TO UNLOCK</b></p> <p>Touch STOP/CLEAR pad and hold for 3 seconds. The display shows LOCK OFF.</p>
<p><b>STANDBY MODE</b></p> <p>This Convection Microwave Drawer will go into standby mode after a period of inactivity. The backlight of the display will automatically dim after 3 minutes if the unit has not been in operation. If the display is in standby mode, simply touch the control panel or open/close the door to return the backlight to maximum brightness.</p>



**SHARP**<sup>®</sup>

SHARP ELECTRONICS CORPORATION • 100 Paragon Drive • Montvale, New Jersey 07645 • USA 100 Paragon Drive • Montvale, New Jersey 07645 • USA

TINSEB579MRR2

MAY 28, 2024