

ASSEMBLY INSTRUCTION





GLOBAL FURNITURE USA

MODEL : 9840 APOLLO



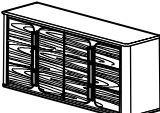

DESCRIPTION : APOLLO-GREY-DR

Thank you for purchasing this quality product. Be sure to check all packing material carefully for small parts which may have loose inside the carton during shipment. Identify and count all parts and compare with the parts list below.

PART LIST#

NO	DRAWING	DESCRIPTION	QTY
A		Dresser	1pc
B		Acrylic Bun Foot	2pcs
C		Metal Leg	2pcs
D		Center Leg	1pc

HARDWARE LIST#

NO	NAME	PART	QTY
1	Allen Key 4mm		1pc
2	JCBC M6 x 20mm		4pcs
3	M6 Spring Washer		4pcs
4	M6 Flat Washer		4pcs

Acrylic Bun Foot cover

Remove Acrylic Bun Foot cover before assemble.

Remove Acrylic Bun Foot carton located in the drawer of the casegood. Remove and unwrap each foot.

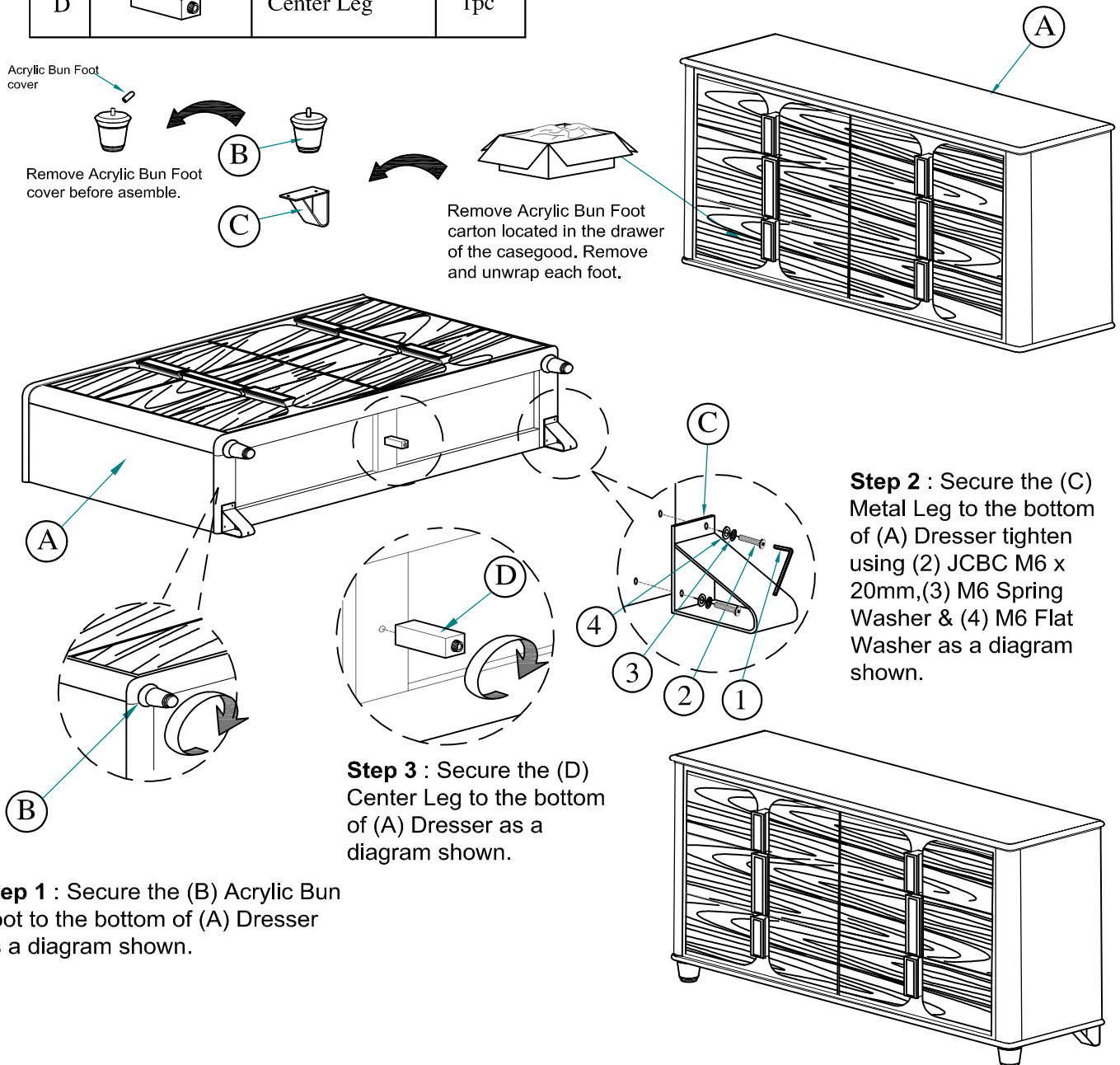





Step 2 : Secure the (C) Metal Leg to the bottom of (A) Dresser tighten using (2) JCBC M6 x 20mm, (3) M6 Spring Washer & (4) M6 Flat Washer as a diagram shown.

Step 3 : Secure the (D) Center Leg to the bottom of (A) Dresser as a diagram shown.

Step 1 : Secure the (B) Acrylic Bun Foot to the bottom of (A) Dresser as a diagram shown.

Assembly completed

HARDWARE LIST (ANTI TIPPING)

NO	NAME	PART	QTY
A	Bracket		2pcs
B	Tie Wrap		1pc
C	Long Screw		1pc
D	Short Screw		1pc

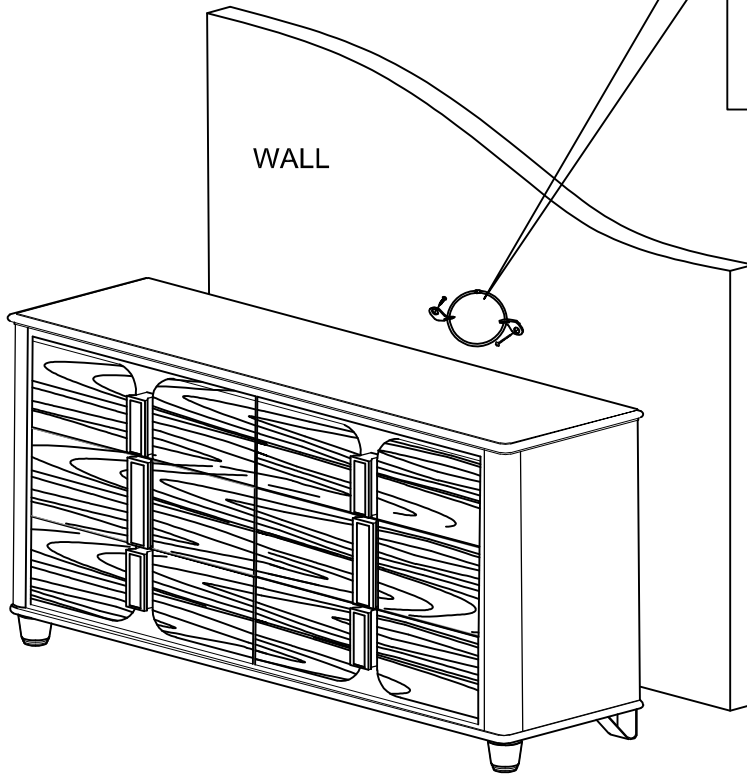
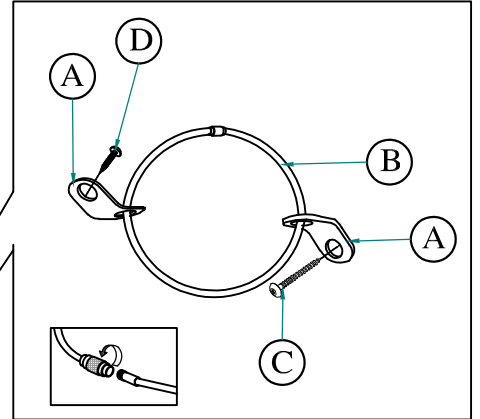

Assembly completed