

ITEM: 935878

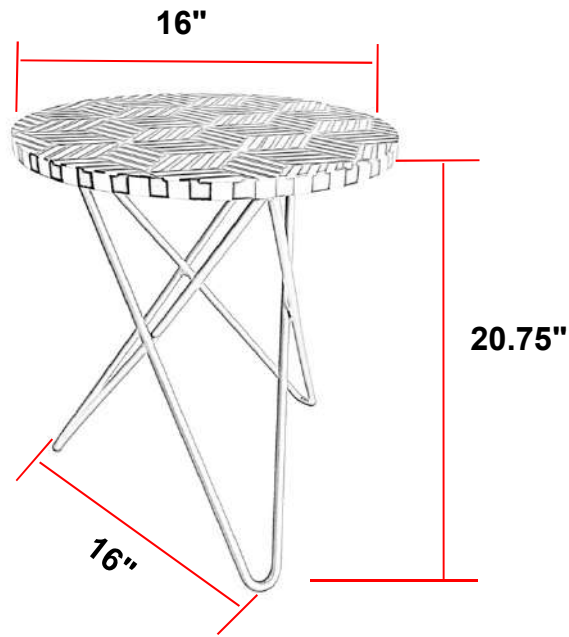

Note: Dimension tolerance $\pm 5\%$