















Assembly Instruction For COUNTER SIDE CHAIR D-11600-7-CSC

Caution: Please read instructions thoroughly before unpacking assembly parts. Sharp, exposed staple tips can cause injury, therefore, for your protection, please remove any exposed staples used in packing.

1. We recommend that you should assemble this product with the assistance of another person; this will make assembly easier, and will help to eliminate damage to the product or injury to persons during assembly.
2. Be sure to check all packing materials carefully for small parts that may have come loose inside the carton during shipment.
3. Please do not over tighten screws or bolts.
4. Please put all parts on a non-abrasive floor before assembly, and follow the assembly steps to assemble your newly purchased product correctly and efficiently.

PARTS LIST				
No.	PART DESC	CODE.	Q'TY	
A	 Solid Back Frame	PD-11600-7-CSCBFR	1	
B	 Seat Frame with Cushion	PD-11600-7-CSCSEC	1	
C	 LSF Front Leg	PD-11600-7-CSCLEG1	1	
D	 RSF Front Leg	PD-11600-7-CSCLEG2	1	
E	 LSF Stretcher	PD-11600-7-CSCSTR1	1	
F	 RSF Stretcher	PD-11600-7-CSCSTR2	1	
G	 Front Stretcher	PD-11600-7-CSCSTR3	1	

HARDWARE LIST				
No.	HARDWARE DESC	CODE.	Q'TY	
1	 ALLEN KEY (M4)		1	
2	 ALLEN BOLT (Ø1/4**3")		4	
3	 ALLEN BOLT (Ø1/4**2-1/2")		4	
4	 ALLEN BOLT (Ø1/4**1-1/2")	PD-11600-CSCHW	2	
5	 SPRING WASHER (Ø1/4")		10	
6	 FLAT WASHER (Ø1/4")		10	
7	 SCREWS (M4*1-3/4")		6	

 Only tighten all bolts when all bolts aligned with bolt inserts

STEP:1

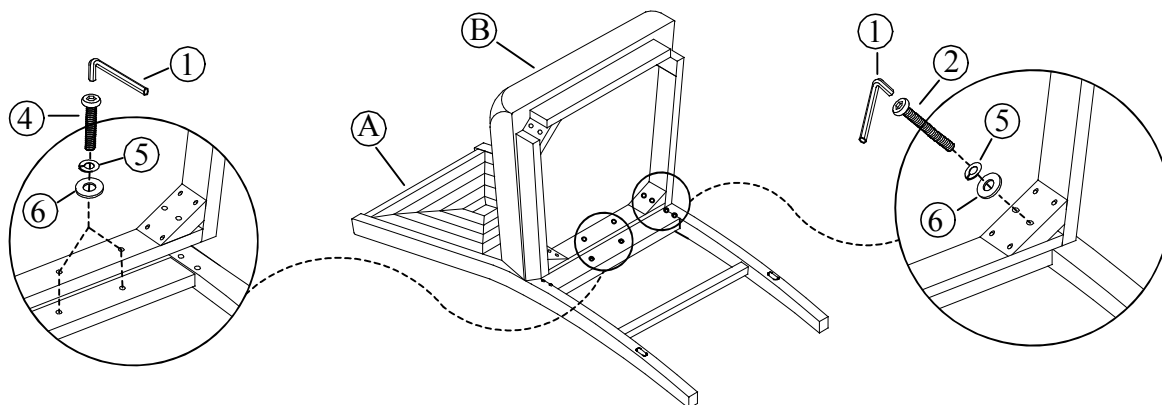

STEP:2

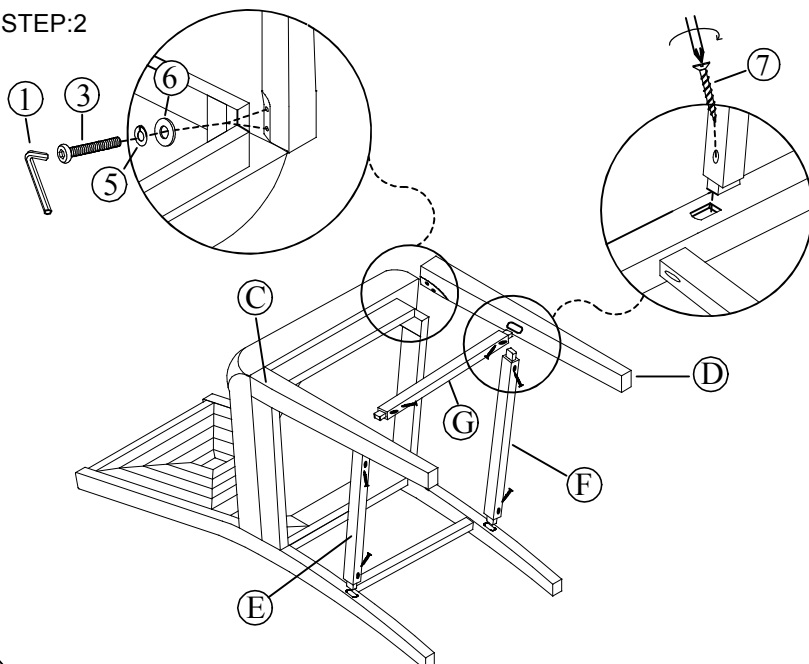

COMPLETED

