



ASSEMBLY INSTRUCTIONS

MODEL #

CM6587

Questions?

GIVE US CALL: 1-888-980-5122
MON-FRI 8:30AM - 5:30PM (PST)

TOOLS REQUIRED



Phillips
Screwdriver
(Not Included)

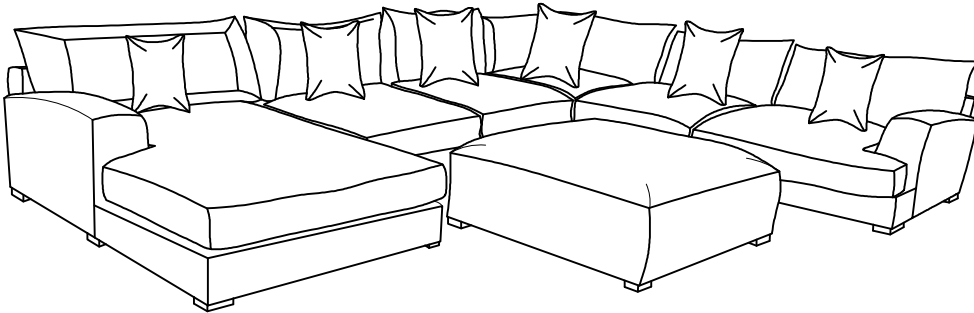

2 - People
Recommended

ASSEMBLY RATING



EASY → DIFFICULT

The Assembly Rating is a 5-point system showing the level of effort needed to assemble a specific product.



Thank you for your purchase!

We hope you enjoy this new addition to your home for many years to come.

Our commitment to providing quality products does not simply end when you purchase our product. We fully stand behind our products from start to finish. Our customer service department is available Monday – Friday 8:30 AM – 5:30 PM Pacific Time and can help with assembly questions as well as, if necessary, replacing damaged or missing parts. To help expedite our service, please have these assembly instructions readily available, along with your order receipt.

 **Consumer Hotline**
Toll-Free 1-888-980-5122

 **WEBSITE**
www.foagroup.com

 **Monday to Friday**
8:30AM- 5:30PM (PT)

 **E-MAIL**
cs.ec@foagroup.com

    foagroup

 FurnitureOfAmerica

CHECK BEFORE STARTING

Are you missing anything?
Double-check all parts, hardware and accessories listed are all accounted for.

Should we send any replacements?
Are there any irregularities or flaws in the parts? We can send replacements!

Check out our Quick Tips!
We recommend reviewing the pre-assembly handouts. Even experts need a refresher now and then!

Prep Time!
Please review the assembly instructions and all diagrams prior to assembling.

PRE ASSEMBLY INTRODUCTION

We understand building ready-to-assemble furniture can be a challenging experience for some. To help avoid confusion, we have provided some helpful tips that may speed up the process.



Teamwork

ALWAYS have at least two people to help with transporting and assembling the product to avoid potential injury and/or damage.



Suitable Location

Assembling near the area of the intended location is highly recommended.



Sufficient Space

Make sure you have enough space to move around during the assembly.



Avoid Scratches

Use cardboard, blankets or a carpeted area while assembling furniture to prevent to prevent scratches and damages.



Flat Surface

Make sure the furniture rests on a flat and level surface with each leg evenly touching the floor.

ASSEMBLY AND CARE ADVICE



FAILURE TO FOLLOW THE GUIDELINES BELOW MAY RESULT IN INJURY AND/OR PROPERTY DAMAGE.



Position each part correctly and insert screws or bolts into their respective holes.



Turn clockwise to tighten and only tighten when step is completed or when instructed to do so.



Use the appropriate hand tools or power tools for assembly. Select steps, such as tightening screws and/or bolts, may require hand tools to avoid causing damage during assembly.



Save the instructions and store any supplied tools for later maintenance.



After two weeks, check and tighten any loose hardware and repeat again every six months thereafter.

IT IS THE USER'S RESPONSIBILITY TO MAINTAIN THE FURNITURE. THE HARDWARE MAY LOOSEN OVER TIME AND MAY CAUSE THE FURNITURE TO BE WOBBLY AND UNABLE TO SUPPORT ITS INTENDED WEIGHT CAPACITY. THIS MAY LEAD TO COLLAPSE AND MAY CAUSE SERIOUS INJURY.

SOFA

CM6587

(CM6587-CEL,CM6587-LVR,CM6587-OT,CM6587-AC)



- Please keep instructions for future reference.
- Check the quantity and irregularity of parts and hardware before you start.

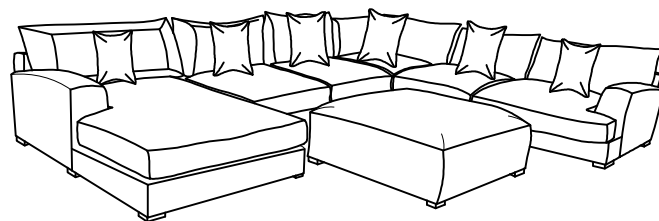

PARTS

#1 1pc



Left Chaise

#2 1pc



Chaise Seat Cushion

#3 1pc



Chaise Back Cushion

#4 2pcs



Armless Chair

#5 2pcs



Chair Seat Cushion

#6 2pcs



Chair Back Cushion

#7 1pc



Corner

#8 1pc



Corner Seat Cushion 1

#9 2pcs



Corner Seat Cushion 2

#10 1pc



Loveseat

#11 1pc



Loveseat
Seat Cushion 1

#12 1pc



Loveseat
Seat Cushion 2

PARTS

#13 1pc



Loveseat
Back Cushion 1

#14 1pc



Loveseat
Back Cushion 2

#15 5pcs

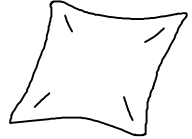

Pillow

#16 1pc

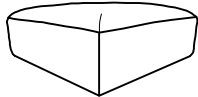

Ottoman

#17 21pcs



Leg

HARDWARE

#A 100pcs







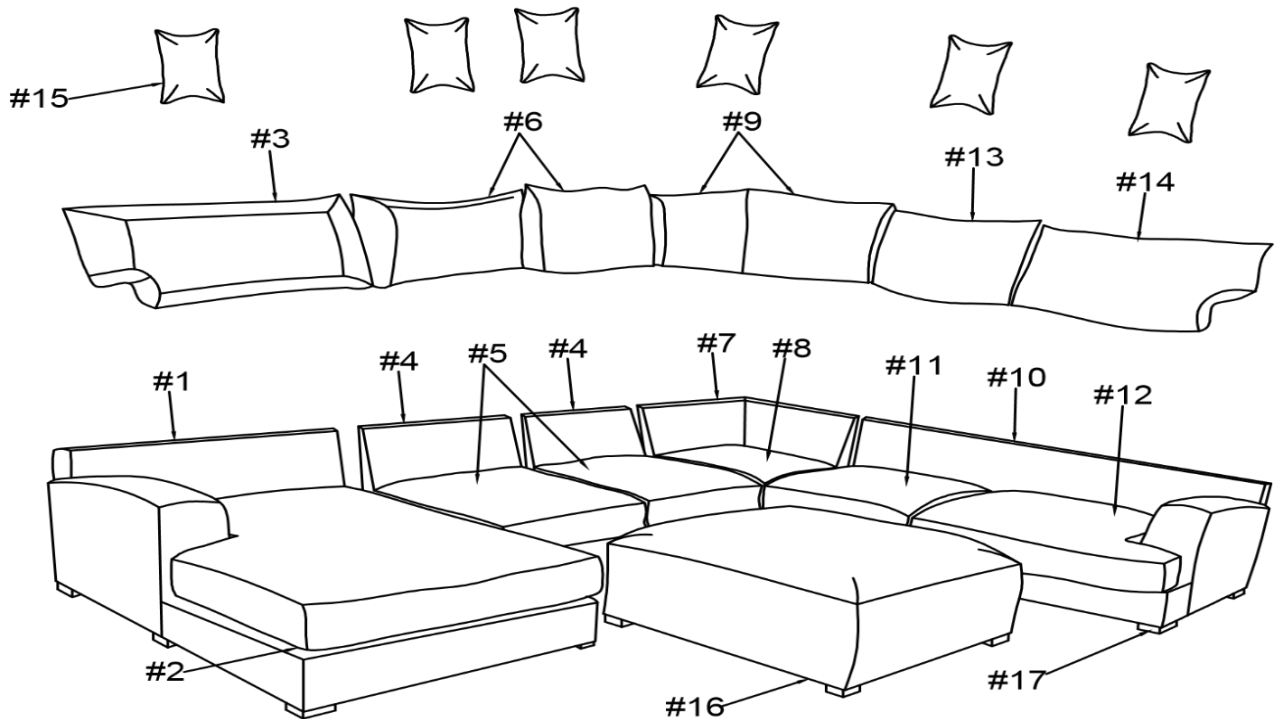









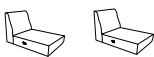













Screw #8 x 60mm

Exploded View



CM6587 is packed in 6 cases

Carton	Disignation	Part	Hardware
CM6587-CE	Left Chair	#1 	 #A x 20pcs
	Left Chair Seat Cushion	#2 	
	Left Chair Back Cushion	#3 	
	Pillow	#15 	
	Leg	#17  x 5	
CM6587-AC (2pcs/set)	Armless Chair	#4 	 #A x 16pcs (x2)
	Armless Chair Seat Cushion	#5 	
	Armless Chair Back Cushion	#6 	
	Pillow	#15 	
	Leg	#17  x 8	
CM6587-CNR	Corner	#7 	 #A x 16pcs
	Corner Seat Cushion	#8 	
	Corner Back Cushion	#9 	
	Pillow	#15 	
	Leg	#17  x 4	
CM6587-LV	Loveseat	#10 	 #A x 16pcs
	Loveseat Seat Cushion 1	#11 	
	Loveseat Seat Cushion 2	#12 	
	Loveseat Back Cushion 1	#13 	
	Loveseat Back Cushion 2	#14 	
	Pillow	#15 	
	Leg	#17  x 4	
CM6587-OT	Ottoman	#16 	 #A x 16pcs
	Leg	#17  x 4	

ASSEMBLY INSTRUCTIONS

There may not be pre-drilled holes when securing legs to bottom of seat.

1

Part #1 x1pc

Part #17 x 5pcs

Hardware #A x20pcs

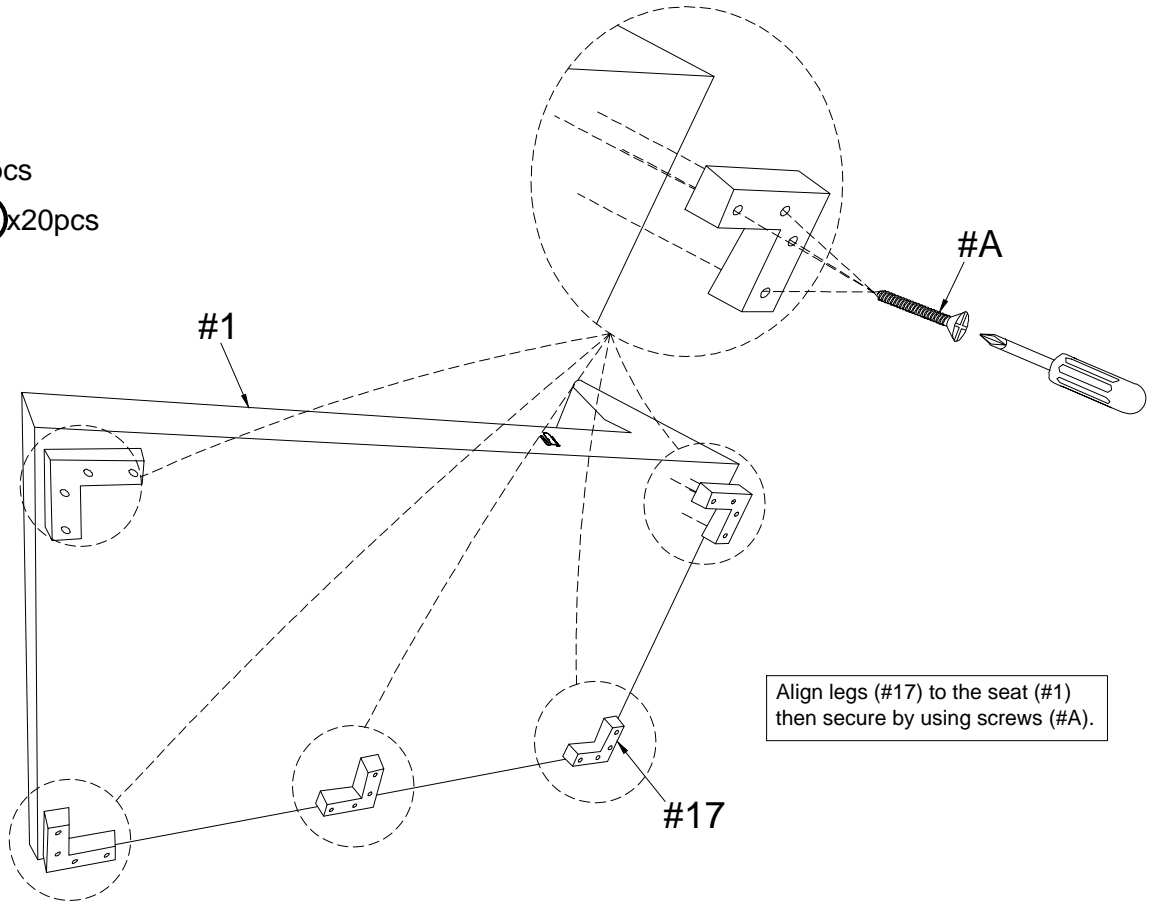

2

Part #2 x1pc

Part #3 x1pc

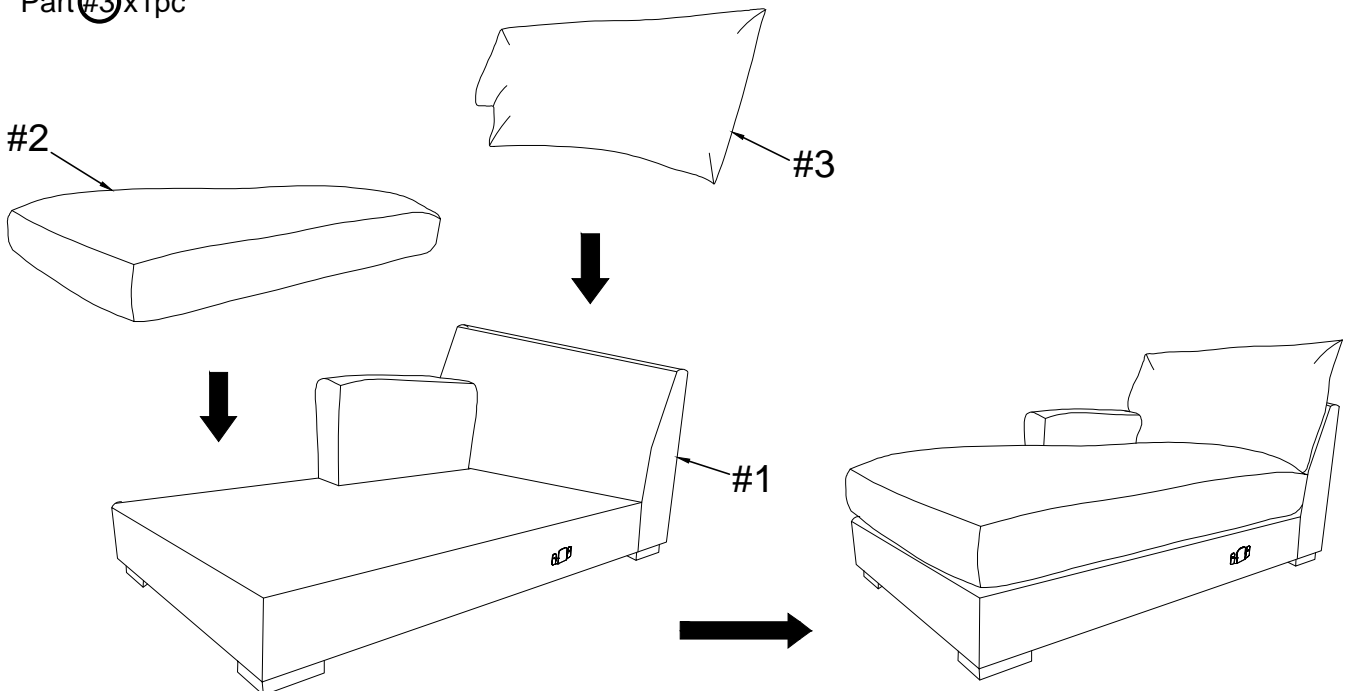

ASSEMBLY INSTRUCTIONS

Align legs (#17) to the seat (#4)
then secure by using screws (#A).

3

Part #4 x1pc

Part #17 x 4pcs

Hardware #A x16pcs

x 2

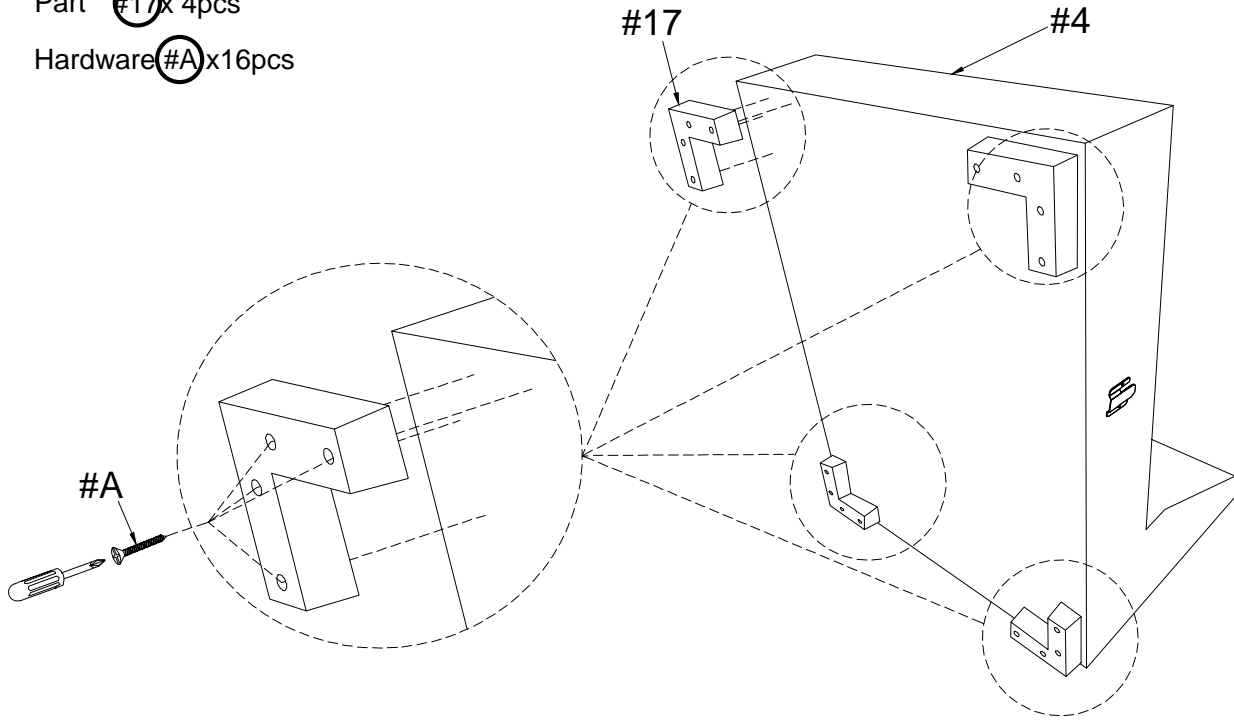

4

Part #5 x1pc

Part #6 x1pc

x 2

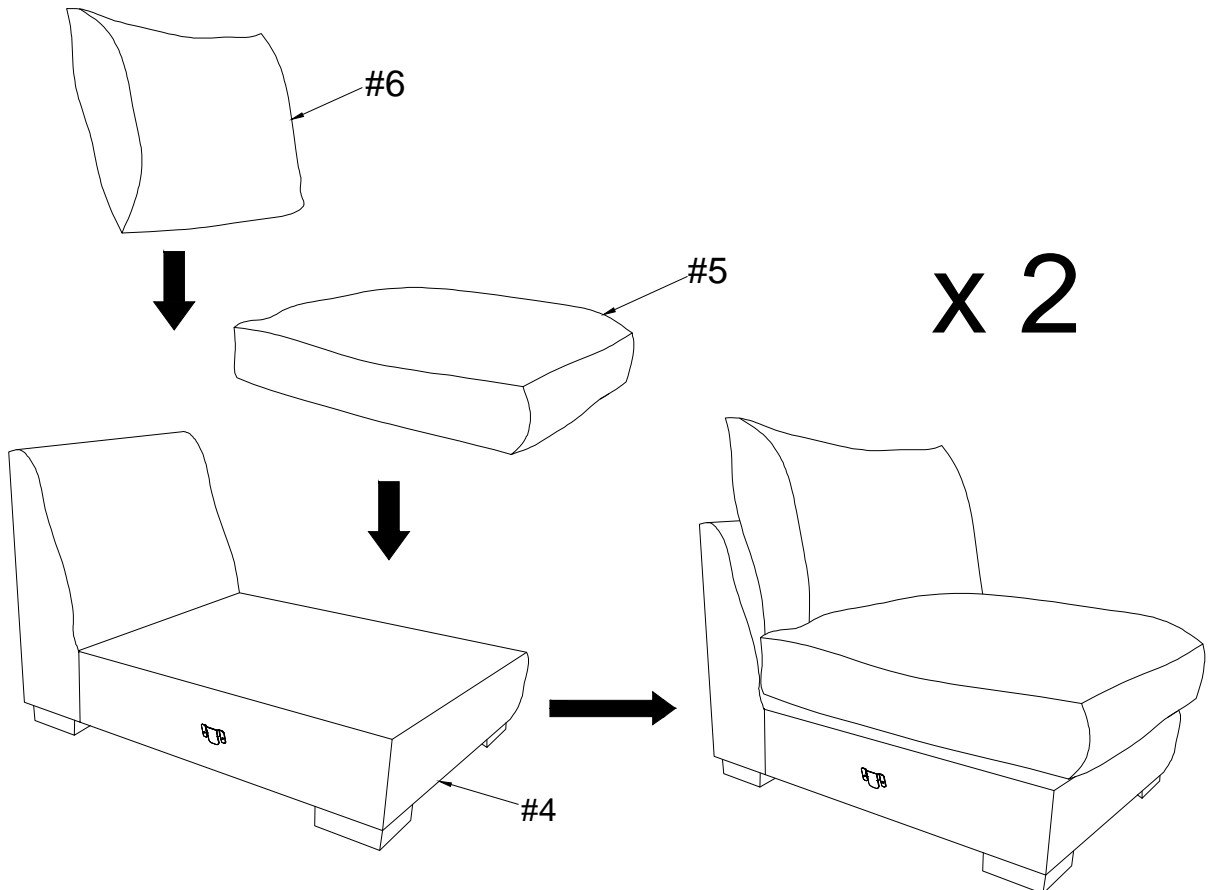

ASSEMBLY INSTRUCTIONS

5

Part #7 x1pc

Part #17 x4pcs

Hardware #A x16pcs

Align leg (#17) to the corner (#7) and secure by using screw (#A).

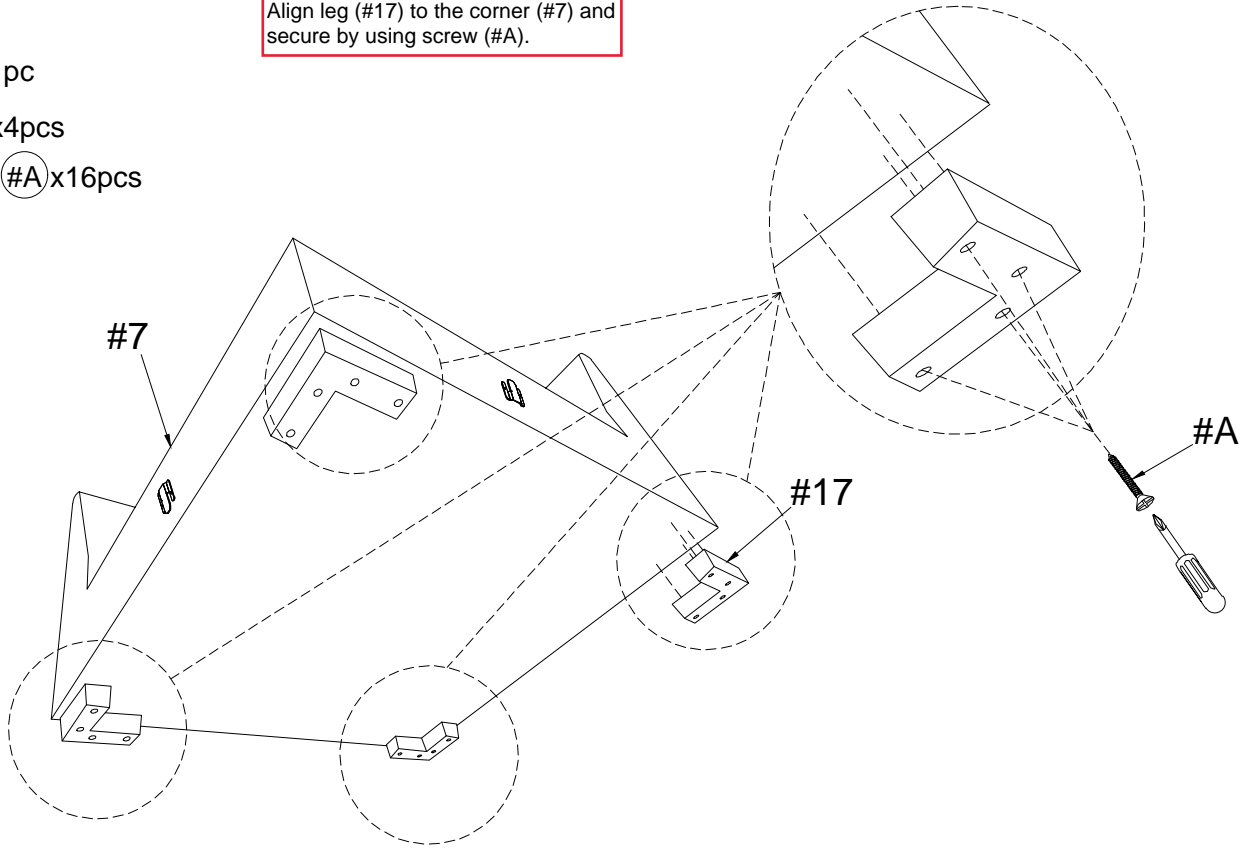

6

Part #8 x1pc

Part #9 x2pcs

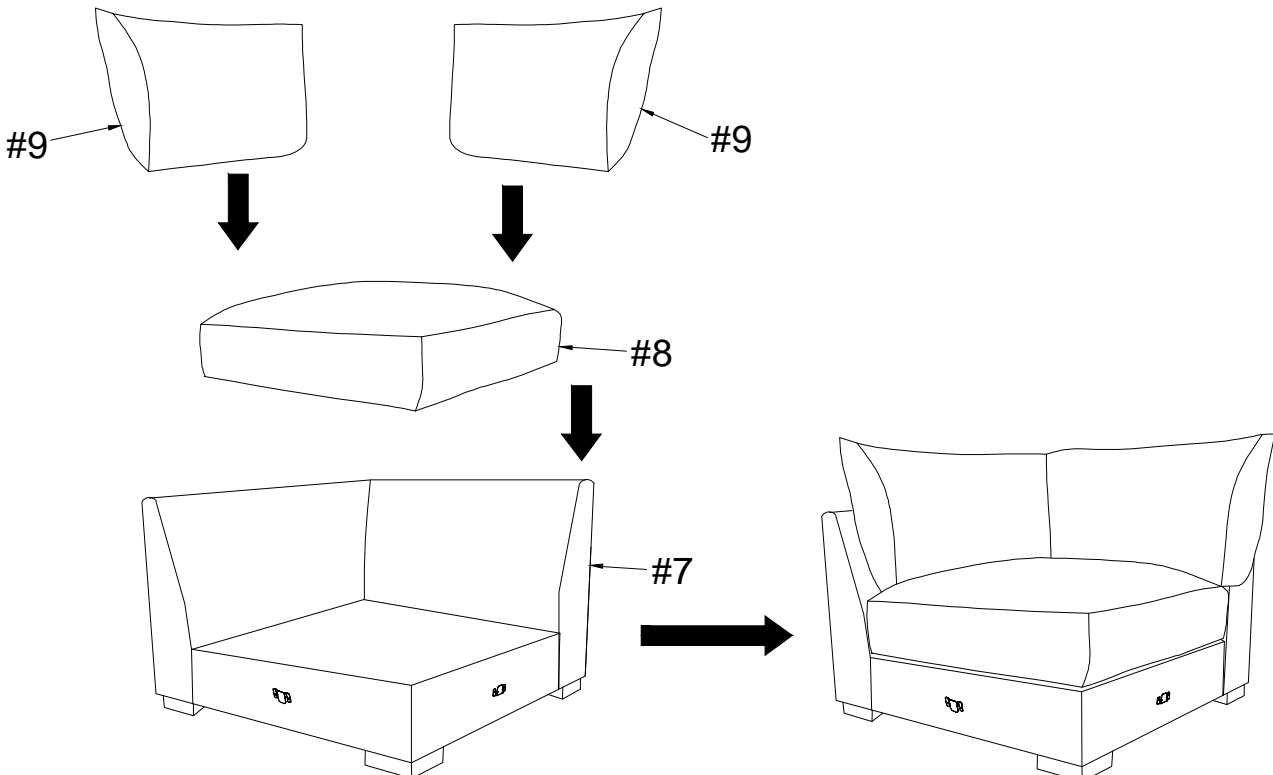

ASSEMBLY INSTRUCTIONS

7

Part #10 x1pc

Part #17 x4pcs

Hardware #A x16pcs

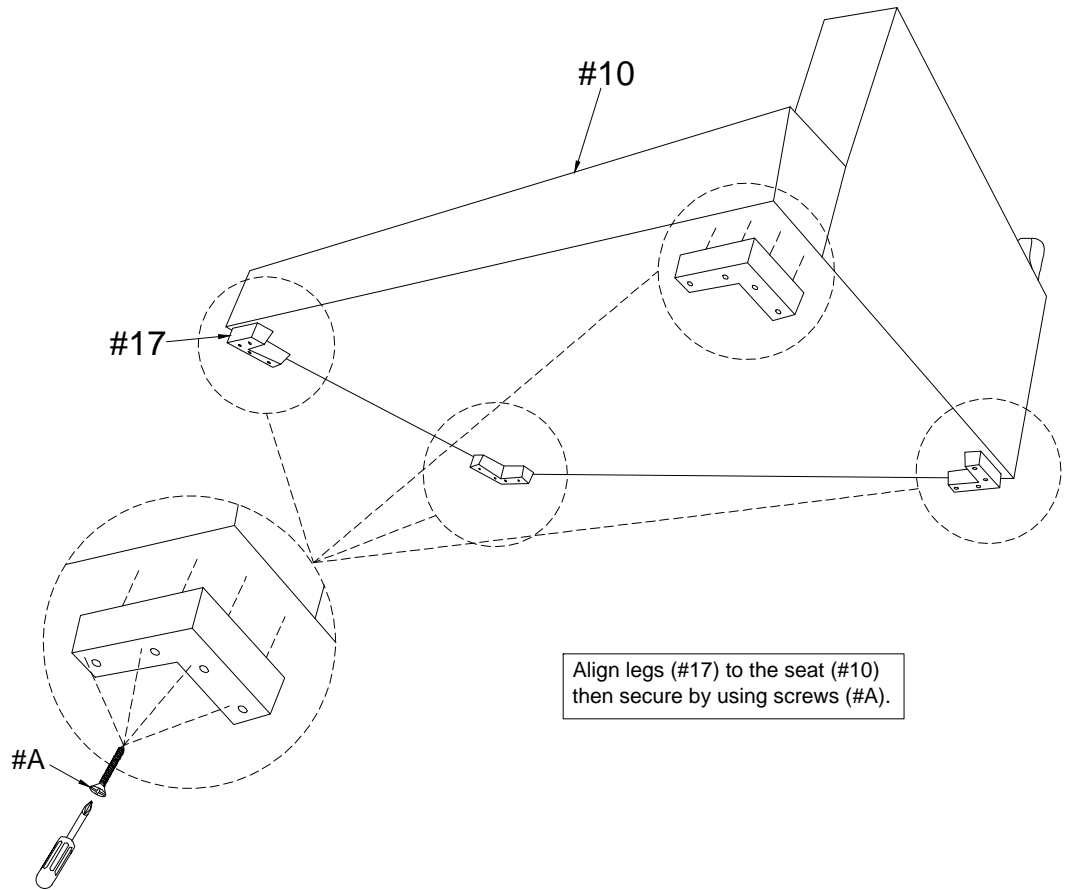

8

Part #11 x1pc

Part #12 x1pc

Part #13 x1pc

Part #14 x1pc

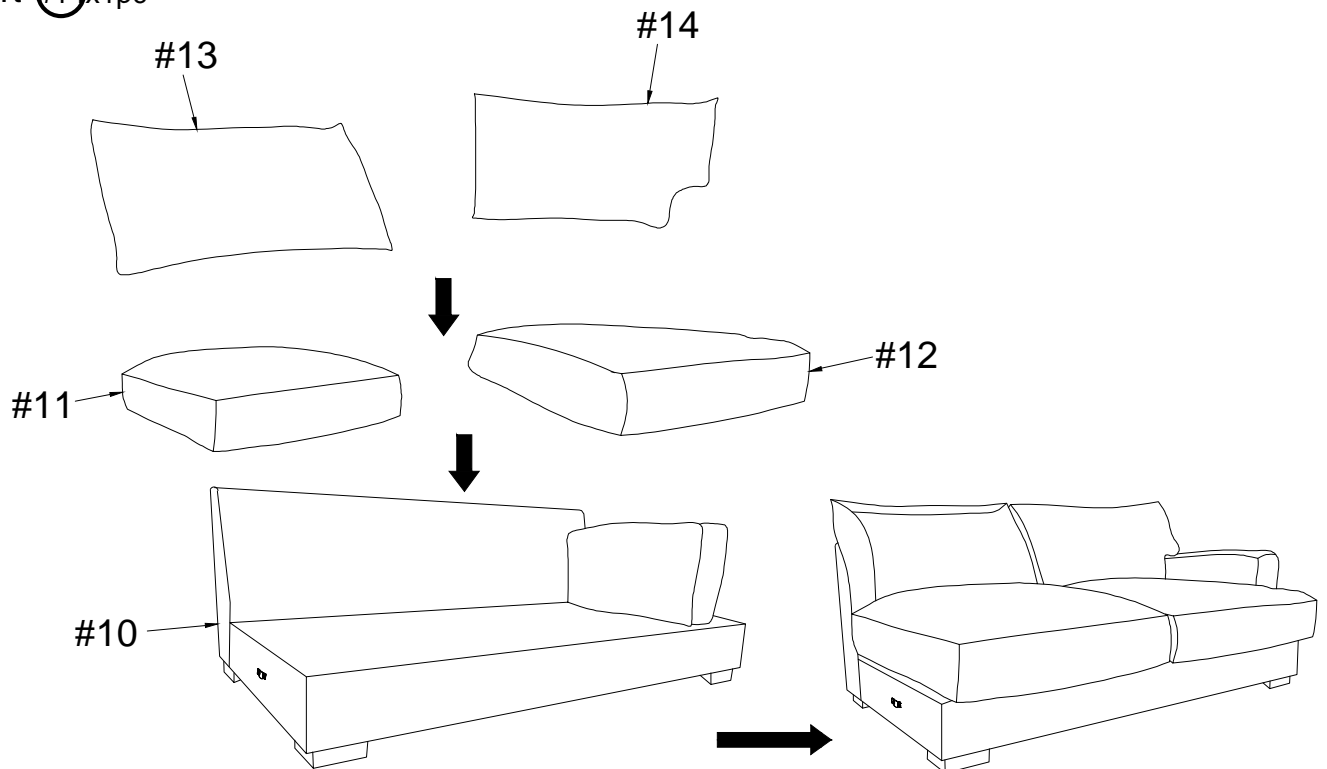

ASSEMBLY INSTRUCTIONS

9

Part #16 x1pc

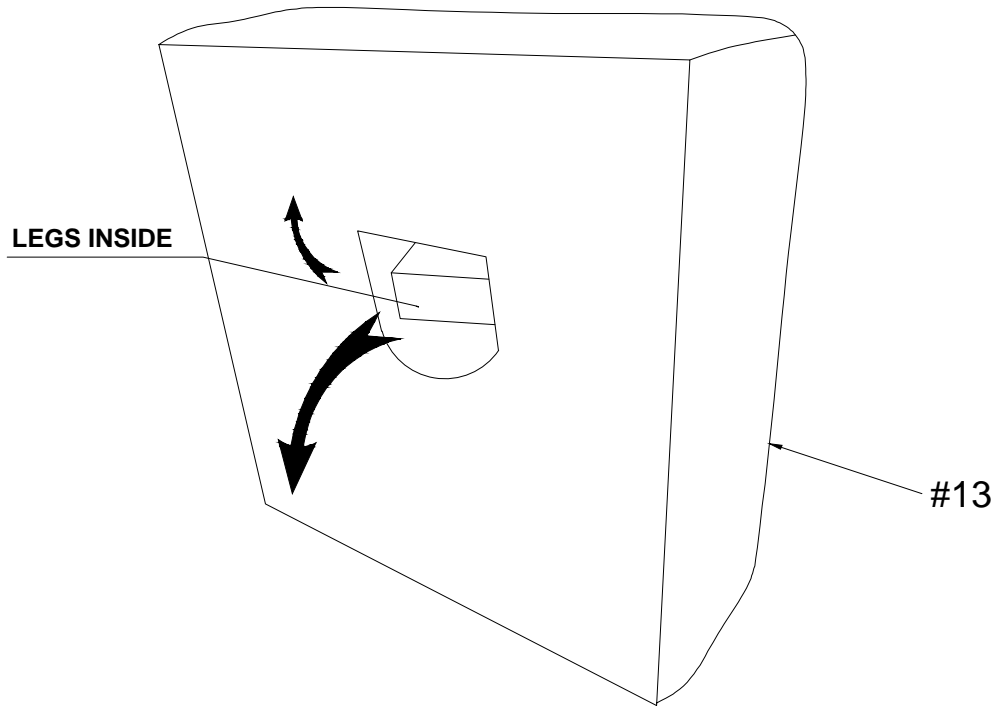

10

Part #16 x1pc

Part #17 x 4pcs

Hardware #A x16pcs

Align legs (#17) to the seat (#16) then secure by using screws (#A).

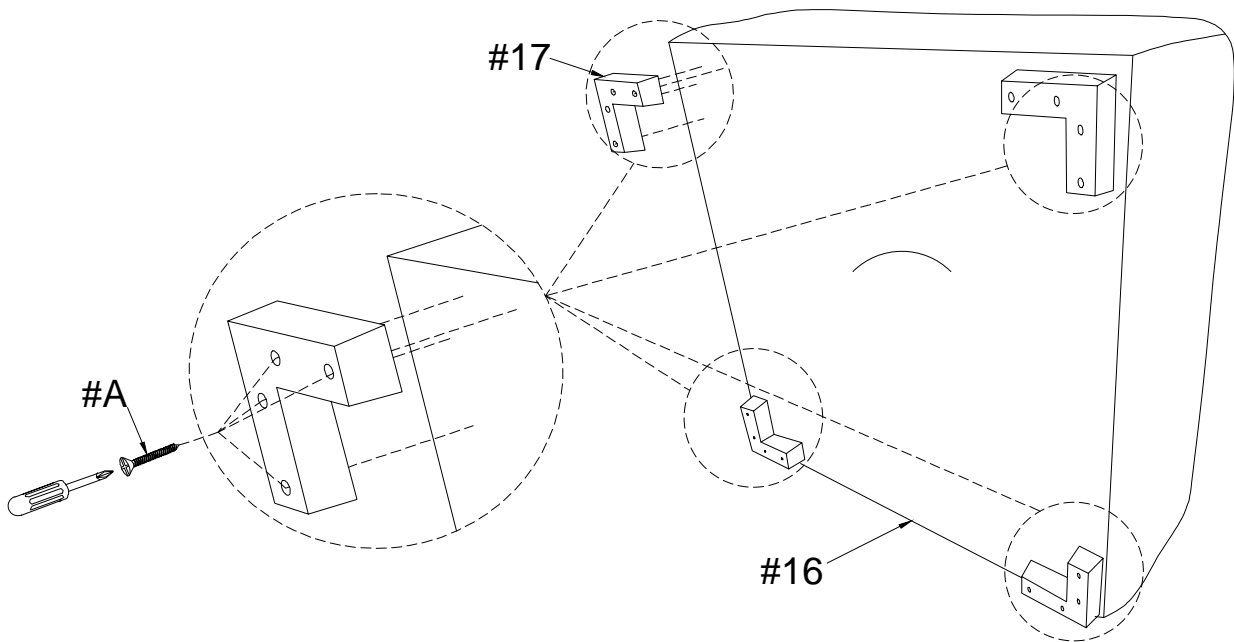

ASSEMBLY INSTRUCTIONS

11

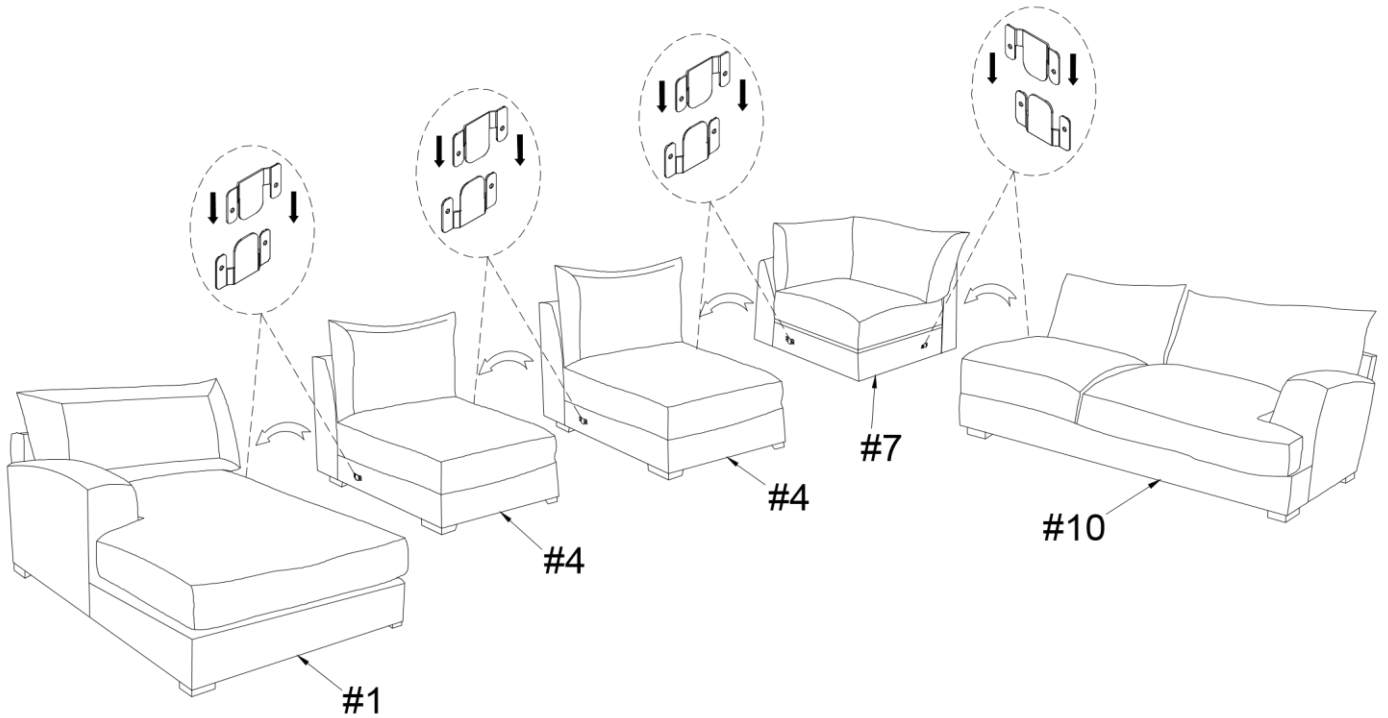

12

Part #15 x 6 pcs

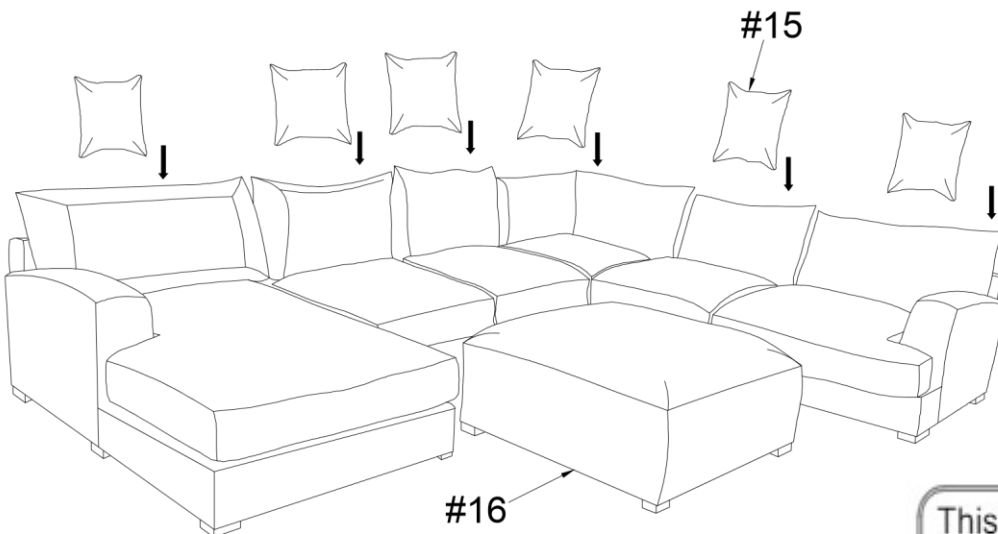

ASSEMBLY COMPLETED



Please ensure the furniture rests on an even and flat surface. If the product wobbles or feels loose, double-check all bolts and/or screws are properly tightened and secured.



Keep this handy!

Please retain this instruction manual and any order-related information for future reference.



Lift, don't drag!

To avoid damage to product please always LIFT the product when transporting or adjusting the placement.

This product is intended for
RESIDENTIAL USE ONLY
and not for commercial use

