

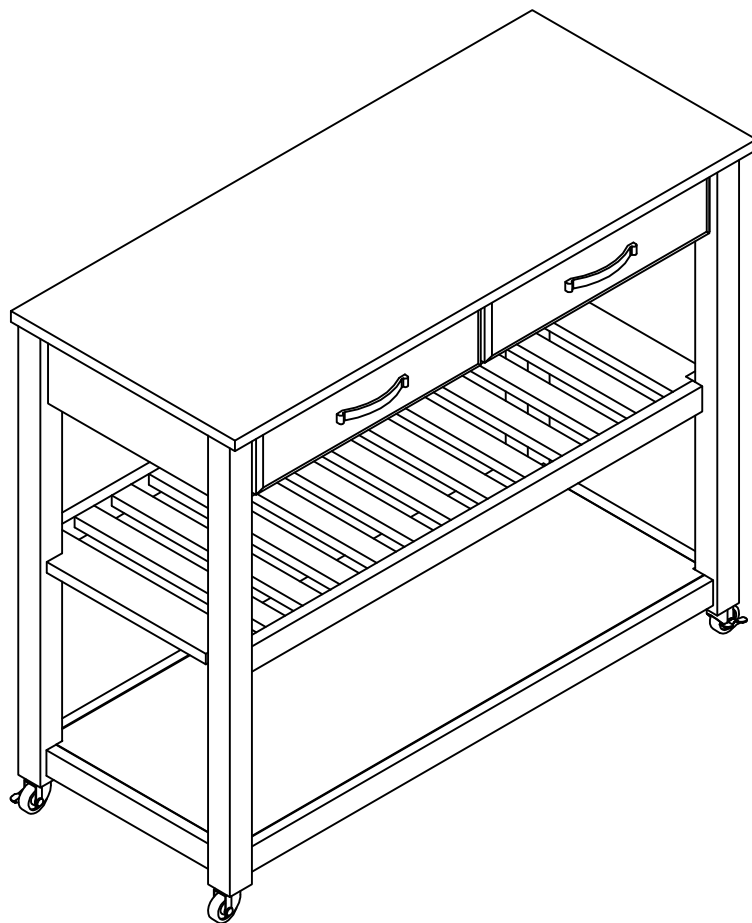

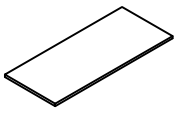

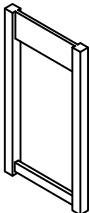

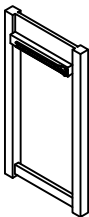

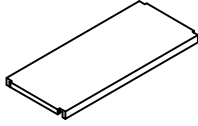
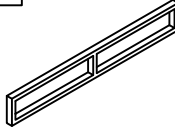
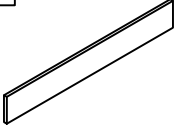



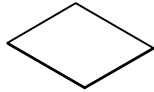

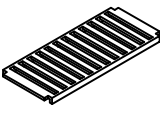









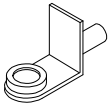

Kitchen Cart Cabinet
CF3005

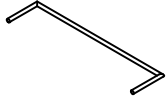

Parts List

1		2		3		4		5		6	
Top panel 1 PC		Left side frame 1 PC		Right side frame 1 PC		Bottom panel 1 PC		Front frame 1 PC		Back panel 1 PC	
7		8		9		10		11		12	
Partition panel 1 PC		Drawer front panel 2 PC		Drawer left side panel 2 PCS		Drawer right side panel 2 PC		Drawer bottom panel 2 PCS		Drawer back panel 2 PCS	
13											
Adjustable shelf 1 PCS											

Hardware List

A		B		C		D		E		F		G	
Cam lock 11 PCS		Cam bolt 11 PCS		Wood Dowel 10 PCS		Drawer pull 2 PCS		Short Round head bolt 4 PCS		Allen Bolt 8 PCS		Allen wrench 1 PC	
H		I		J		K		L		M		 2 PCS  1 PC  2 PCS  2 PCS  1 PC	
Screw 16 PCS		Shelf holder 4 PCS		Long Round head bolt 2 PCS		Towel bar 1 PC		Castor With Brake 2 PCS		Castor Without Brake 2 PCS		EXTRA	

Tools Needed: Allen Wrench(Part#G)(included)
Phillips Head Screw Driver(Not included)

Step 1. Insert Cam Bolts (B) into pre-drilled holes of parts (1, 2, 3, 5 & 6) using a Phillips head screwdriver. DO NOT OVERTIGHTEN.

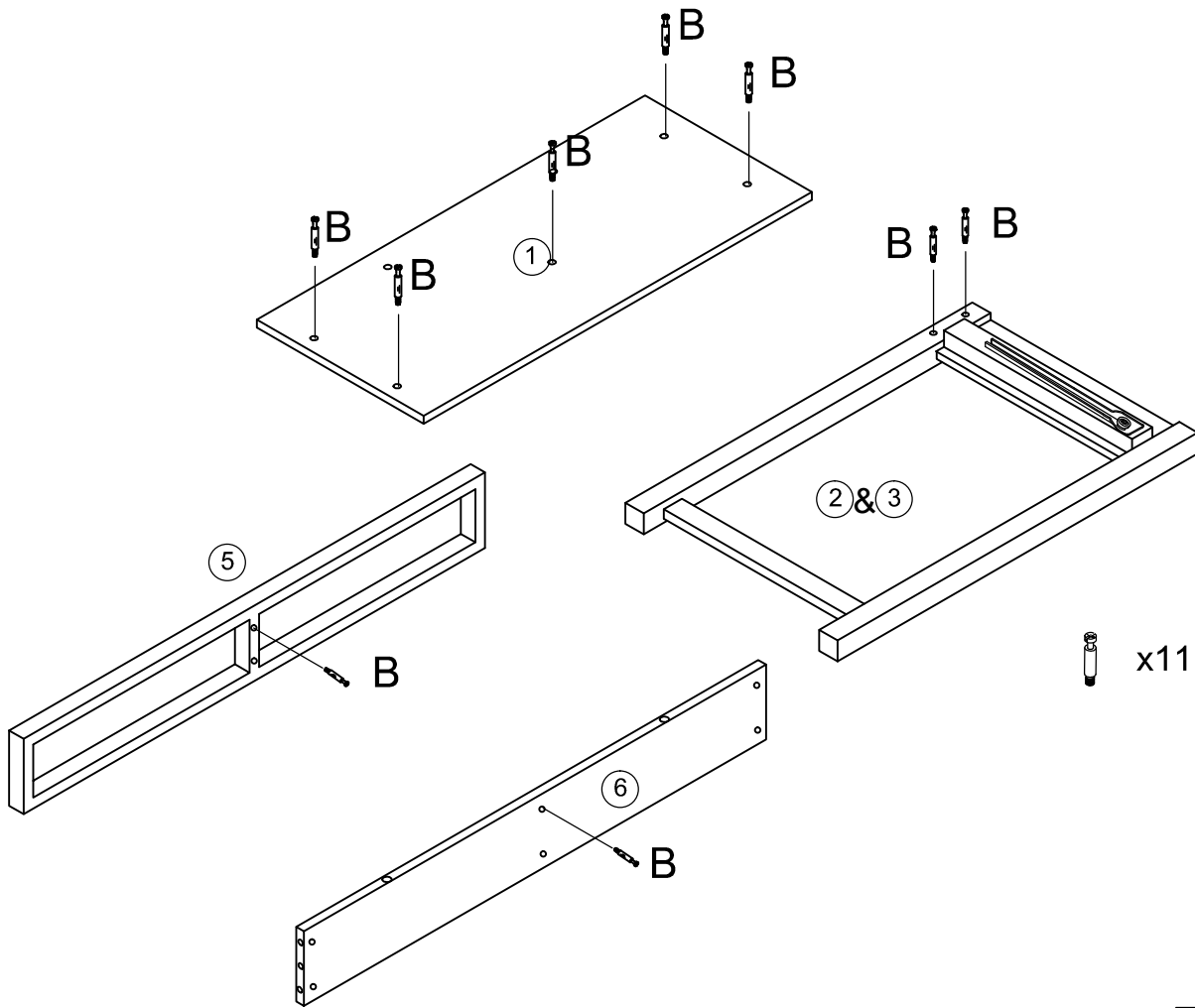



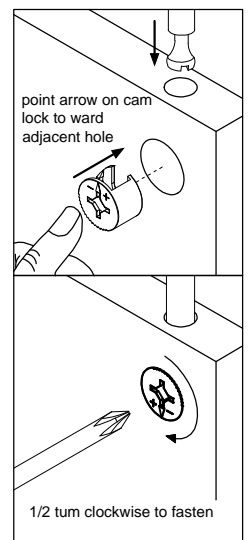
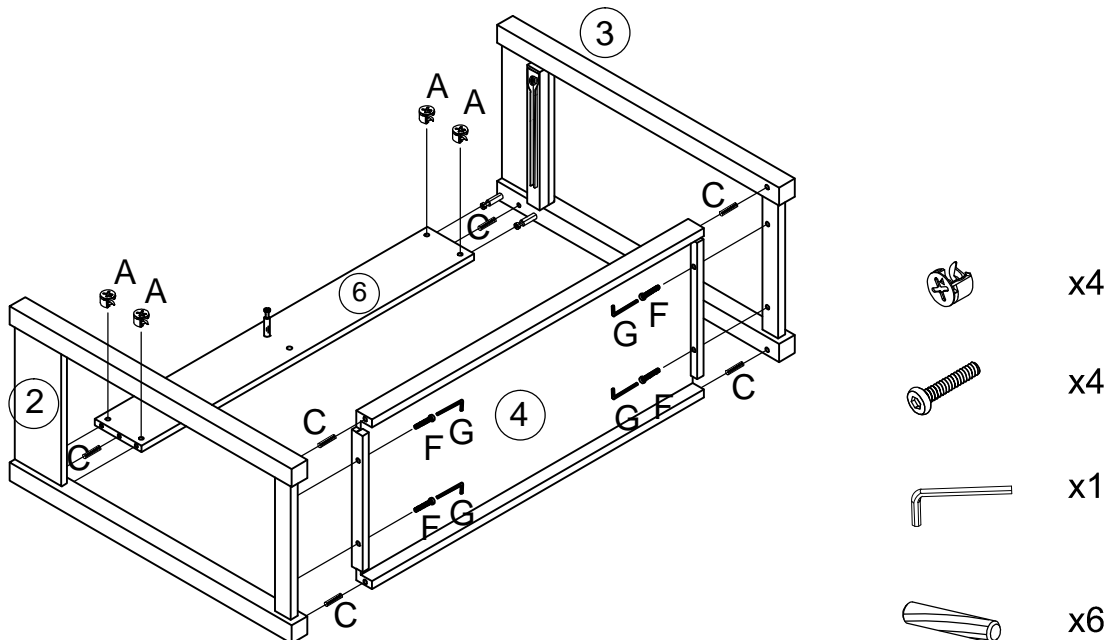

Step 2. Lay Back Panel (6) on a flat surface with Cam Bolt (Part B) facing up. Attach Right Side Frame (3) to Back Panel (6) using Cam Locks (A) & Wood Dowels as shown. Now attach Right Side Frame (3) to Bottom Panel (4) using Allen Bolts (F) as shown. Repeat the previous steps for Left Side Frame (2).

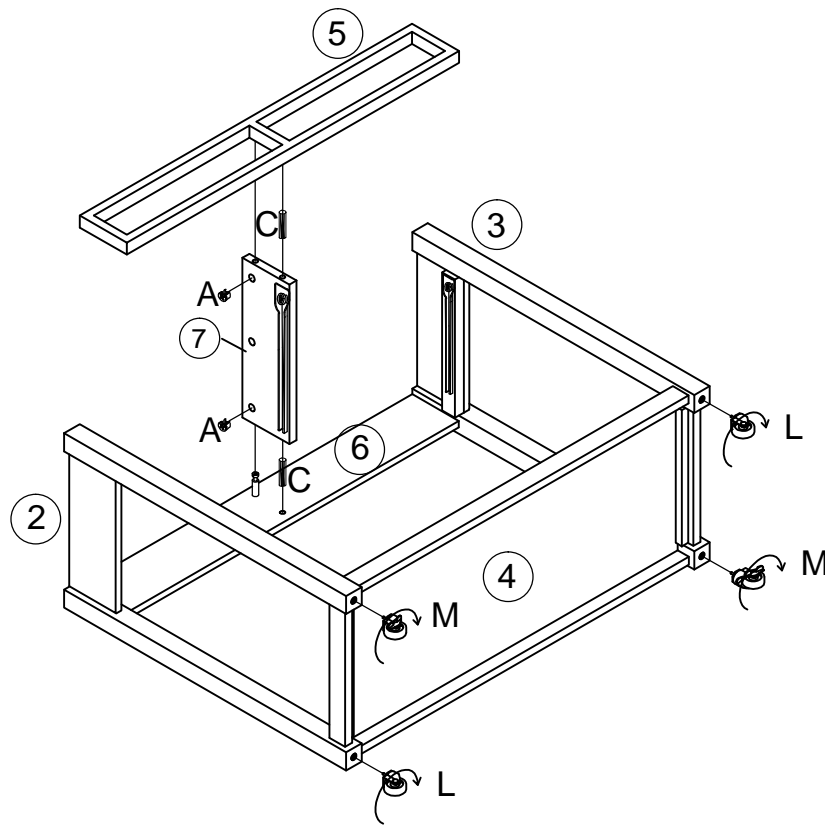
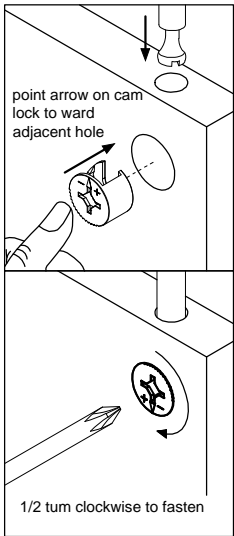

Step 3.

Attach Partition Panel (7) to Back Panel (6) using Cam Lock (A) & Wood Dowel (C) as shown. Note - Be sure the wheels on the drawer glide are facing the front of the cabinet. Now attach Front Frame (5) to Partition Panel (&) using Cam Lock (A) & Wood Dowel (C) as shown. Attach Caster with brake (L) & Caster (M) to Right & Left Side Frames (2 & 3) by rotating clockwise.





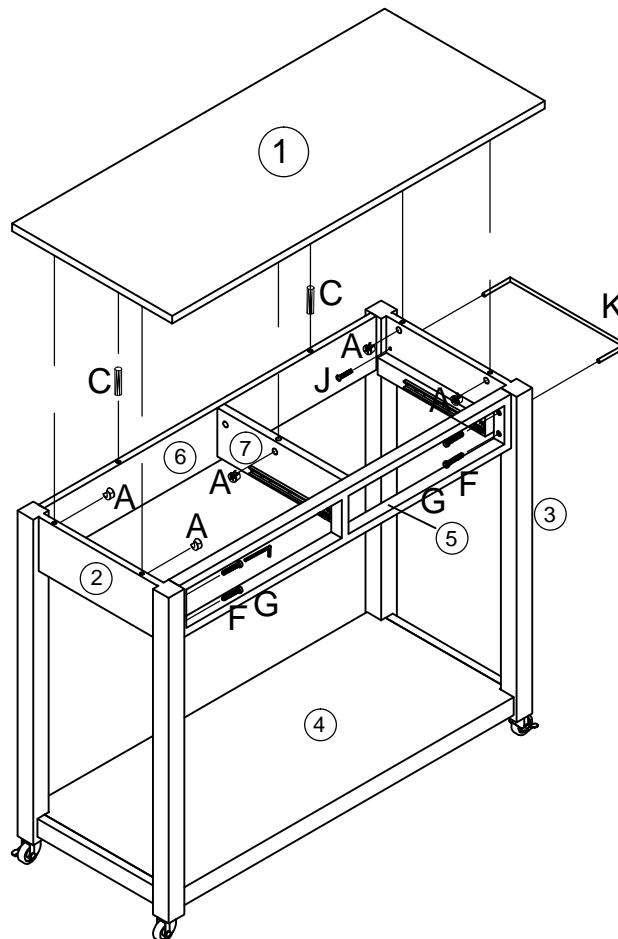
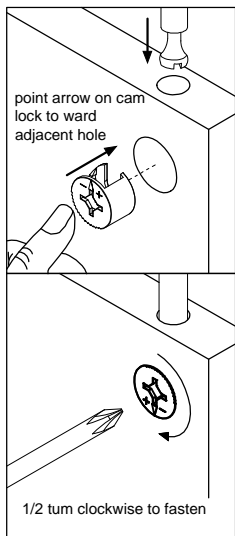

-  x2
-  x2
-  x2
-  x2

Step 4.

Attach Front Frame (5) to Right & Left Side Frames (2 & 3) using Allen Bolts (F) as shown. Attach Towel Bar (K) to Right Side Frame (3) using Long Round Head Bolts (J) as shown. Now attach Top (1) using Cam Locks (A) & Wood Dowels (C) as shown.

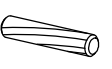
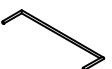

-  x5
-  x4
-  x1
-  x2
-  x1
-  x2

Step 5. Assemble drawers by attaching Drawer Front (8) to Left & Right Side Panels (9 & 10) using Screws (H). NOTE: BE SURE THAT THE WHEELS ON DRAWER GLIDES ARE AT THE OPPOSITE SIDE OF THE DRAWER FRONT. Insert Bottom Panel (11) into the grooves of Side Panels (9 & 10). Attach Back Panel (12) to Side Panels (9 & 10) using Screws (5) as shown. Attach Drawer Pull (D) to Drawer Front (8) using Short Round Head Bolt (E) as shown.

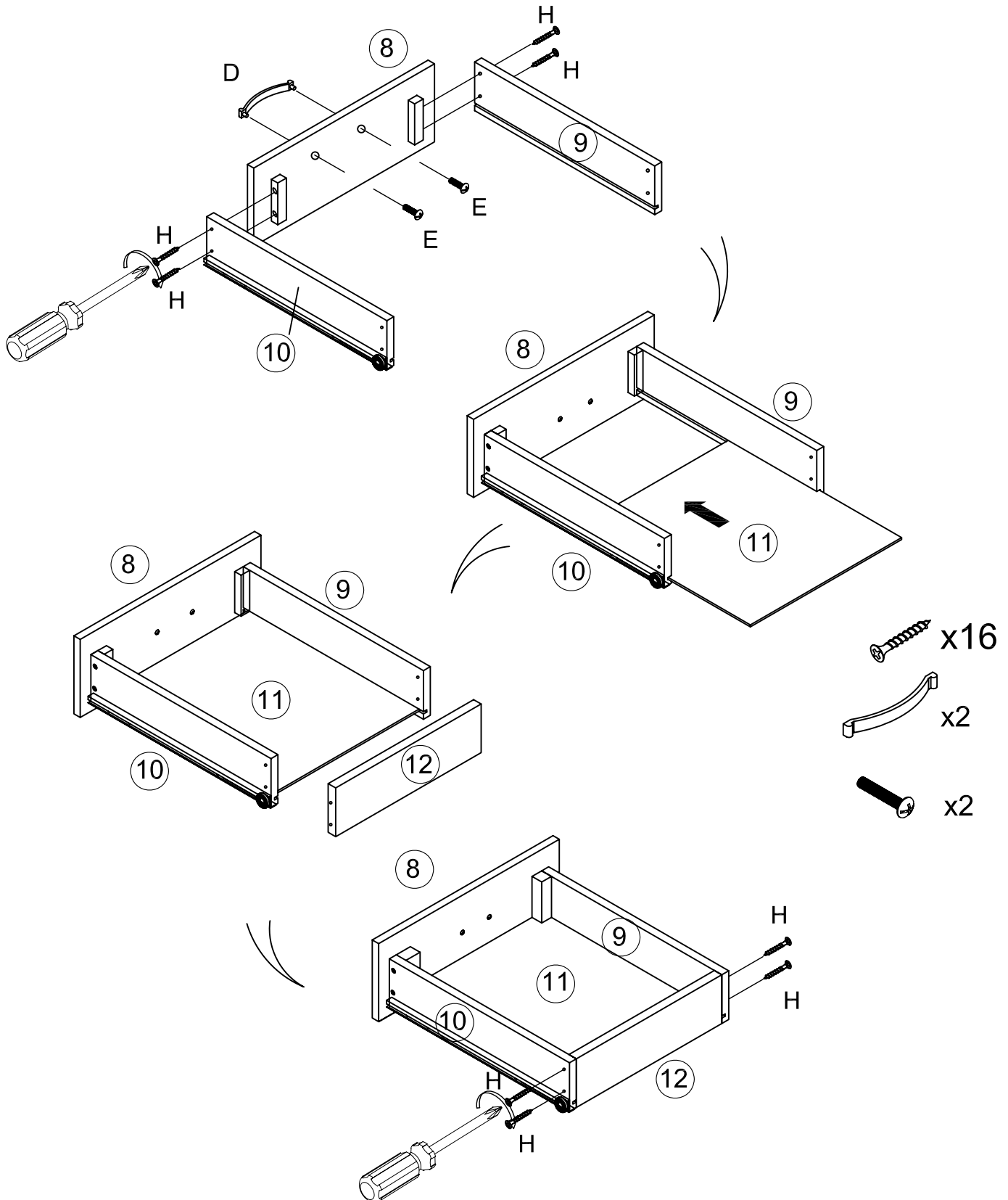

Step 6. Insert the assembled drawers into the cabinet.

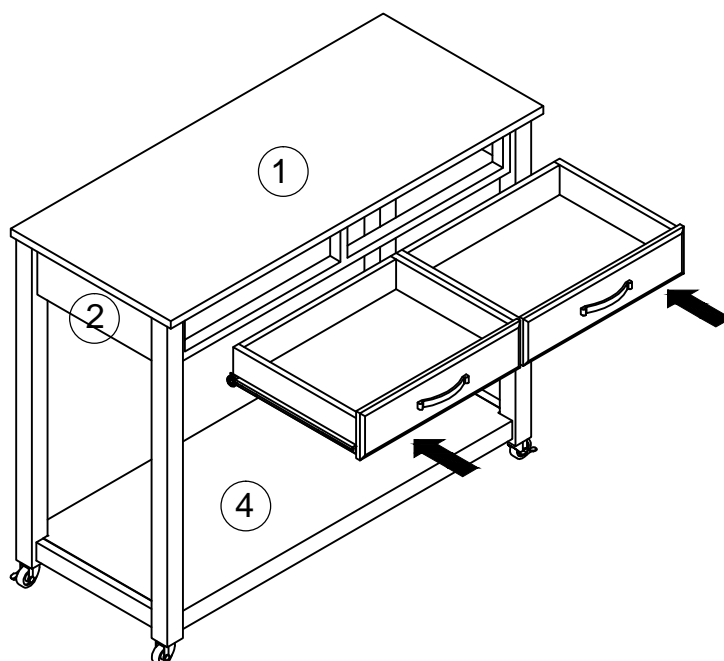

Step 7. Insert the Shelf Holders (I) into the desired location and add Adjustable Shelf (13).
Note - If you intend to use the lower portion of the island for stool storage, do not add adjustable shelf (13). Congratulations! You are finished.

