

EN FRONT LOAD WASHER

FR LAVEUSE À CHARGEMENT FRONTAL

ES LAVADORA DE CARGA FRONTAL

USE & CARE GUIDE

GUIDE D'UTILISATION ET D'ENTRETIEN

GUÍA DE USO Y CUIDADO

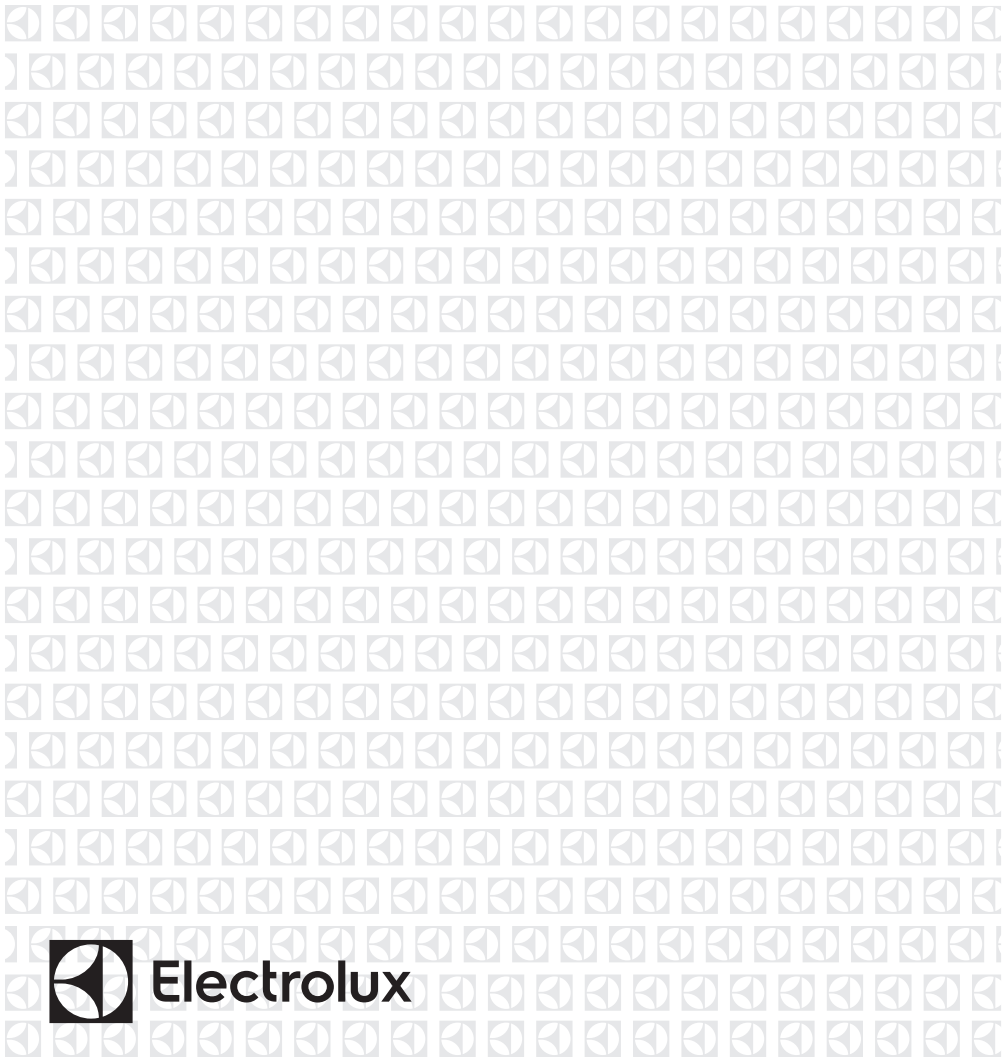

2 Important Safety Information

Please read and save this guide

Thank you for choosing Electrolux, our premium brand in home appliances. This *Use & Care Guide* is part of our commitment to customer satisfaction and product quality throughout the service life of your new appliance.

Keep a record for quick reference

Purchase date

Electrolux serial number

Electrolux model number

Electrolux model series*

*The series number can be found within the Model number (example EFLS627UTT= 600 series).

Table of contents

Important Safety Information.....	2
Features	6
Pre-Installation Requirements	7
Installation	11
Controls and Settings	18
Operating Instructions	28
Normal Operating Sounds	33
Stain Removal Guide	34
Care and Cleaning	36
Troubleshooting	41
Limited Warranty	47

Questions?

For toll free telephone support or online support in the US and Canada contact:

U.S.

1-877-4ELECTROLUX (1-877-435-3287)
www.electroluxappliances.com

Canada

1-800-265-8352
www.electroluxappliances.ca



NOTE

Registering your product with Electrolux enhances our ability to serve you. You can register online at www.electroluxappliances.com, by sending your Product Registration Card in the mail, or PHOTOREGISTERSM using a smart phone. See registration card for details.



NOTE

The instructions appearing in this *Use & Care Guide* are not meant to cover every possible condition and situation that may occur. Common sense and caution must be practiced when installing, operating and maintaining any appliance.



WARNING

For your safety the information in this manual must be followed to minimize the risk of fire or explosion or to prevent property damage, personal injury or loss of life. Do not store or use gasoline or other flammable vapors and liquids in the vicinity of this or any other appliance.

**READ ALL INSTRUCTIONS BEFORE OPERATING THIS WASHER.
SAVE THESE INSTRUCTIONS FOR FUTURE REFERENCE.**

Important safety instructions

Safety precautions

DO NOT attempt to install or operate your unit until you have read the safety precautions in this manual. Safety items throughout this manual are labeled with a Danger, Warning, or Caution based on the risk type.



DANGER

DANGER indicates an imminently hazardous situation which, if not avoided, will result in death or serious injury.



WARNING

WARNING indicates a potentially hazardous situation which, if not avoided, could result in death or serious injury.



WARNING - RISK OF FIRE

To reduce the risk of fire, electrical shock, or injury to persons when using this washer, comply with the warnings listed below. Failure to comply with these Important Safety Information and warnings could result in property damage, serious personal injury, or death.

Prevent fire

- DO NOT wash items that have been previously cleaned in, soaked in, or spotted with gasoline, cleaning solvents, kerosene, cooking oils, waxes, or other flammable or explosive substances. DO NOT store these items on or near the washer. These substances give off vapors or chemical reactions that could ignite or explode.
- DO NOT put oily or greasy rags or clothing on top of the washer. These substances give off vapors that could ignite the materials.
- DO NOT add gasoline, cleaning solvents, or other flammable or explosive substances to the wash water. These substances give off vapors that could ignite or explode.
- Under certain conditions, hydrogen gas may be produced in a hot water system that has not been used for 2 weeks or more. **HYDROGEN GAS IS EXPLOSIVE.** If the hot water system has not been used for such a period, before using the washer, turn on all hot water faucets and let the water flow from each for several minutes. This will release any accumulated hydrogen gas. Hydrogen gas is flammable; DO NOT smoke or use an open flame during this time.
- DO NOT store or use gasoline or other flammable vapors or liquids in the vicinity of this or any other appliance.
- Failure to comply with these warnings could result in fire, explosion, serious bodily injury and/or damage to the rubber or plastic parts of the washer.
- DO NOT continue to use the washer if you hear squeaking, grinding, rubbing or other unusual noises. This could be a sign of mechanical breakdown and lead to fire or serious injury. Contact a qualified technician immediately.

Definitions

 This is the safety alert symbol. It is used to alert you to potential personal injury hazards. Obey all safety messages that follow this symbol to avoid possible injury or death.



CAUTION

CAUTION indicates a potentially hazardous situation which, if not avoided, may result in minor or moderate injury.



IMPORTANT

Indicates installation, operation, or maintenance information which is important but not hazard-related.

4 Important Safety Information

Protect children

- DO NOT allow children to play on or in the washer. Close supervision of children is necessary when the washer is used near children. As children grow, teach them the proper, safe use of all appliances.
- Destroy the carton, plastic bag and other packing materials after the washer is unpacked. Children might use them for play. Cartons covered with rugs, bedspreads or plastic sheets can become airtight compartments.
- Keep laundry products out of children's reach. To prevent personal injury, observe all warnings on product labels.
- Before the washer is removed from service or discarded, remove the washer door to prevent accidental entrapment.
- Failure to comply with these warnings could result in serious personal injuries.

Risk of child entrapment

Child entrapment and suffocation are not problems of the past. Junked or abandoned washers and dryers are still dangerous – even if they will sit for “just a few days”. If you are getting rid of your old washer or dryer, please follow the instructions below to help prevent accidents.

We strongly encourage responsible appliance recycling/disposal methods. Contact your State/Province Energy Office, Local Electric and Water Utilities or Conservation Program Office or visit www.energystar.gov/recycle for more information on recycling your old washer or dryer.

Before you throw away your old washer or dryer:

- Remove doors
- Remove the electric power cord
- Secure all hoses and drain pipes to prevent water from leaking out and creating a slip hazard.

Prevent injury

- To prevent shock hazard and assure stability during operation, the washer must be installed and electrically grounded by a qualified service person in accordance with local codes. Installation instructions are packed in the washer for installer's reference. Refer to the Installation sections of this guide

for detailed grounding procedures. If the washer is moved to a new location, have it checked and reinstalled by a qualified service person.

- To prevent personal injury or damage to the washer, the electrical power cord of the washer must be plugged into a properly grounded and polarized 3-prong outlet. The third grounding prong must never be removed. Never ground the washer to a gas pipe. DO NOT use an extension cord or an adaptor plug.



WARNING

FIRE/ELECTRICAL SHOCK HAZARD

Avoid fire hazard or electrical shock. DO NOT use an adaptor plug or extension cord or remove grounding prong from electrical power cord. Failure to follow this warning can cause serious injury, fire or death.



WARNING

Improper grounding of the washer may cause serious injury or death. Check with a licensed electrician if you are in doubt as to whether the appliance is properly grounded.

Grounding type wall receptacle



Do not, under any circumstances, cut, remove, or bypass the grounding prong.

Power cord with 3-prong grounded plug

- Follow package directions when using laundry products. Incorrect usage can produce poisonous gas - resulting in serious injury or death.
- DO NOT combine laundry products for use in 1 load unless specified on the label.



WARNING

HARMFUL VAPOR HAZARD

DO NOT use or mix liquid chlorine bleach with other household chemicals such as toilet cleaners, rust removers, acids such as vinegar, or products containing ammonia. These mixtures can produce dangerous fumes which can cause serious injury or death.



WARNING

RISK OF INJURY

DO NOT WASH: Water resistant and water repellent clothing or other materials. Failure to follow these instructions may result in an abnormal vibrating and out-of-balance condition that could result in physical injury, property damage, and/or appliance damage.



Prevent injury and damage to the washer

To prevent serious personal injury and damage to the washer:

- All repairs and servicing must be performed by an authorized service technician unless specifically recommended in this *Use & Care Guide*. Use only authorized factory parts.
- DO NOT tamper with controls.
- DO NOT install or store the washer where it will be exposed to the weather.
- DO NOT install on carpet. Install washer on a solid floor. It may be necessary to reinforce the floor to prevent vibration or movement.
- To reduce the risk of electric shock, disconnect this appliance from the power supply before attempting any user maintenance. Turning the controls to the OFF position does not disconnect this appliance from the power supply.
- To prevent injury, DO NOT reach into the washer while parts are moving.
- This washer is equipped with an electrical overload protector. The motor will stop if it becomes overheated.
- Failure to comply with these warnings could result in serious personal injuries.

6 Features

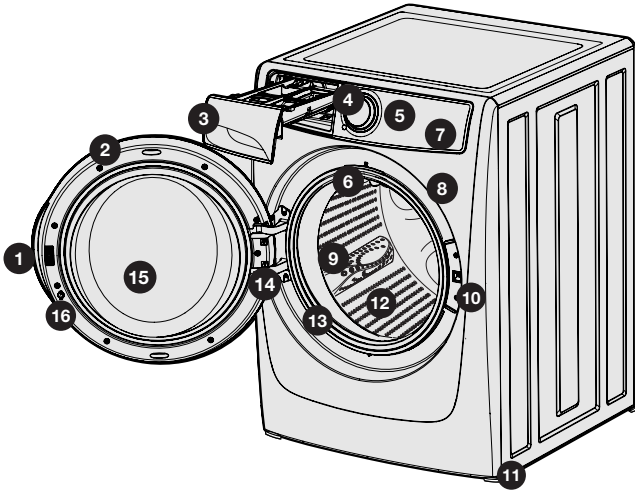

Not all cycles, options, or features listed are available on every model.

1. Door striker	9. Cascading wash vanes
2. Reversible door (400/500/600 series only)	10. Door latch with safety lock
3. Laundry products dispenser	11. Adjustable leveling legs
4. LED Display	12. Stainless steel wash drum
5. Cycle Display	13. Flexible door gasket
6. Drum light (select models)	14. Wide angle door hinge
7. Control lock	15. Inner glass with small article redistribution ramp
8. Serial and model #	16. Door stand ventilation

Refer to the table below for an overview of features available for each model series.

	drum light	door reversibility	3 compartment dispenser	Adaptive Dispenser™	detergent pack option	sanitize	stain treatment	perfect steam	wrinkle release	fast wash
300 Series	no	no	yes	no	no	no	no	no	no	no
400 Series	no	yes	no	yes	no	no	yes	no	yes	20 ^{min}
500 Series	yes	yes	no	yes	yes	yes	yes	yes	yes	18 ^{min}
600 Series	yes	yes	no	yes	yes	yes	yes	yes	yes	15 ^{min}

Installation Checklist

Shipping Hardware

- Foam shipping support (under wash tub) removed and stored
- Shipping bolts and spacers removed from rear of appliance and stored
- Hole plugs (shipped in bag in drum) installed in holes in backsheet

Leveling

- Washer is level, side-to-side and front-to-back
- Cabinet is sitting solid on all corners

Water Supply

- Use only new hoses and verify rubber sealing washers are installed
- HOT supply is connected to HOT inlet and COLD supply is connected to COLD inlet
- HOT and COLD water supply turned on
- No leaks present at water supply connections or appliance inlet connections - recheck in 24 hours

Drain

- Stand pipe or wall drain height minimum 24"
- Verify anti-siphon disc is attached toward end of drain hose
- Drain hose secured in place with cable tie (shipped in drum)

Door Reversal

- Follow detailed instructions in this guide
- Test hinge and latch for function

Electrical Power

- House power turned on
- Washer plugged in

Final Checks

- Installation instructions and Use & Care Guide read thoroughly
- Door locks and water enters drum when cycle starts
- Registration card sent in

Tools and materials needed for installation:

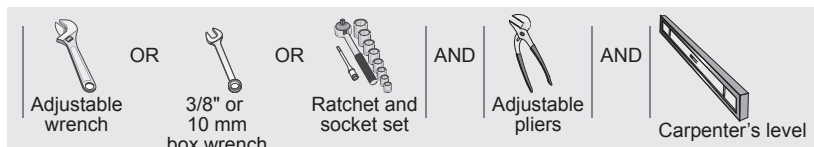

Inlet Hose (x2)



NOTE

Hoses are not included with washer purchase.

Electrical system requirements

CIRCUIT - Individual, properly polarized and grounded 15 amp. branch circuit fused with 15 amp. time delay fuse or circuit breaker.

POWER SUPPLY - 2 wire, with ground, 120 volt single phase, 60 Hz, Alternating Current.

OUTLET RECEPTACLE - Properly grounded 3-prong receptacle to be located so the power supply cord is accessible when the washer is in an installed position.

8 Pre-Installation Requirements



NOTE

Because of potentially inconsistent voltage capabilities, the use of this washer with power created by gas powered generators, solar powered generators, wind powered generators or any other generator other than the local utility company is not recommended.



WARNING

ELECTRIC SHOCK HAZARD

Certain internal parts are intentionally not grounded and may present a risk of electrical shock if contacted during installation. Do not contact the following parts while the appliance is energized

- Pump
- Drive motor
- Electrical control boards
- Water valves



WARNING

ELECTRICAL SHOCK HAZARD

Improper connection of the equipment grounding conductor can result in a risk of electrical shock. Check with a licensed electrician if you are in doubt as to whether the appliance is properly grounded.

Grounding type wall receptacle



Do not, under any circumstances, cut, remove, or bypass the grounding prong.

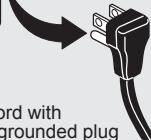

Power cord with 3-prong grounded plug

Grounding requirements

1. The washer **MUST** be grounded. In the event of malfunction or breakdown, grounding will reduce the risk of electrical shock by a path of least resistance for electrical current.
2. Since your washer is equipped with a power supply cord having an equipment-grounding conductor and a grounding plug, the plug **MUST** be plugged into an appropriate, copper wired receptacle that is properly installed and grounded in accordance with all local codes and ordinances or in the absence of local codes, with the National Electrical Codes, ANSI/NFPA 70 (latest edition), or in Canada, the Canadian electrical code C22.1 part 1. If in doubt, call a licensed electrician. **DO NOT** cut off or alter the grounding prong on the power supply cord. In situations where a two-slot receptacle is present, it is the owner's responsibility to have a licensed electrician replace it with a properly grounded three prong grounding type receptacle.

Water supply requirements

Hot and cold water faucets **MUST** be installed within hose length of your washer's water inlet. The faucets **MUST** be 3/4 inch (1.9 cm) with threading for laundry hose connection. Water pressure **MUST** be between 20 and 120 psi. Pressure difference between hot and cold cannot be more than 10 psi. Your water department can advise you of your water pressure.

Drain system requirements

1. Drain capable of eliminating 17 gals (64.3 L) per minute.
2. A standpipe diameter of 1-1/4 in. (3.18 cm) minimum.
3. The standpipe height above the floor :
Minimum height: 24 in. (61 cm)
Maximum height: 96 in. (244 cm).

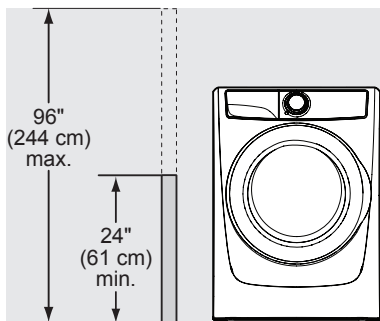
**NOTE**

Drain hose length is 59 in. (150 cm). For installations requiring a longer drain hose, use hose P/N 137098000, available from an authorized parts distributor.

Clearance requirements**IMPORTANT****DO NOT INSTALL YOUR WASHER:**

1. In an area exposed to dripping water or outside weather conditions.
2. In an area where gasoline or other flammables are kept or stored.
3. On carpet. Floor **MUST** be solid with a maximum slope of 1 inch (2.5 cm). To minimize vibration or movement, reinforcement of the floor may be necessary.
4. On top of another washer or on top of a dryer. Do not stack a dryer on top of washer already installed on pedestal.

Installation in a recess or closet

If washer and dryer are installed in the same closet, door ventilation is required: A minimum of 120 square inches (774.2 cm²) of opening, equally divided at the top and bottom of the door, is required. Louvered openings should be located 3 inches (7.6 cm) from bottom and top of door. Air openings are required to be unobstructed when a door is installed. A louvered door with equivalent air openings for the full length of the door is acceptable.

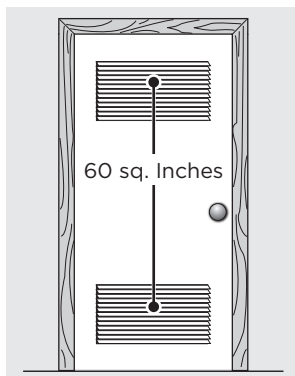

120 sq. Inches Equally Divided Split Vent Door

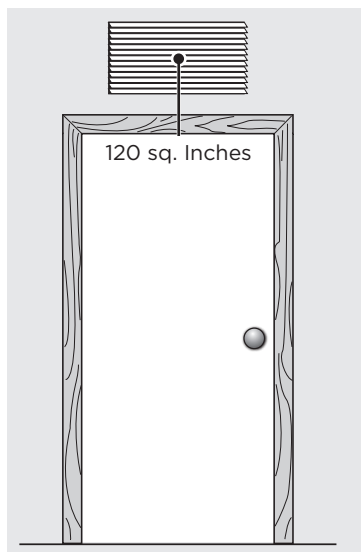

Solid Door with Wall Ventilation

10 Pre-Installation Requirements

120 sq. Inches min.
Louvered Opening

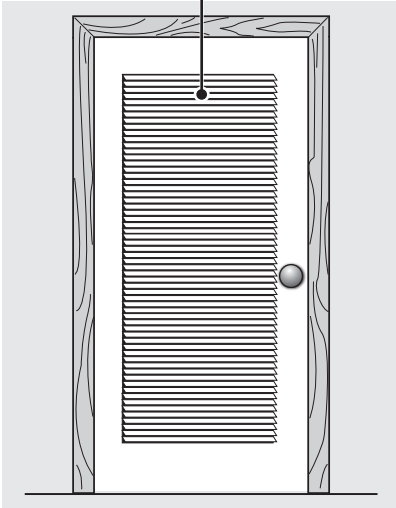

Louvered Door

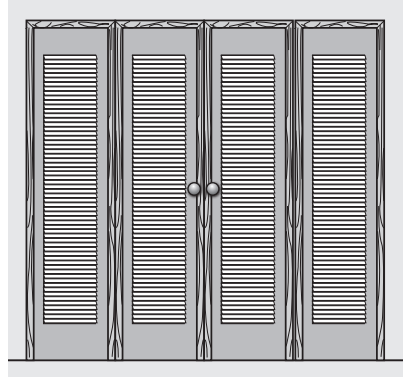

Bi-Fold louvered doors with
120 sq. in of ventilation

120 sq. Inches of
wall venting

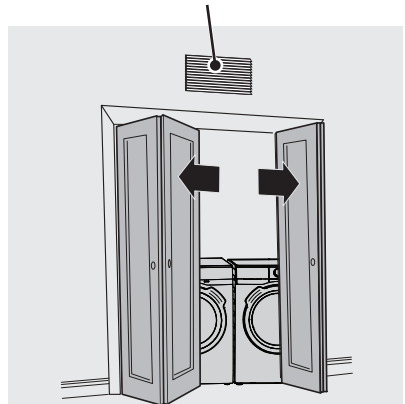

Solid Bi-Fold doors with no
ventilation

MIN. INSTALLATION CLEARANCES - Inches (cm)

	Sides	Rear	Top	Front
Alcove/ recess	0" (0 cm)	0" (0 cm)	0" (0 cm)	Open
Closet with door vent	0" (0 cm)	0" (0 cm)	0" (0 cm)	1" (2.5 cm)
Closet with wall vent	1" (2.5 cm)	1" (2.5 cm)	1" (2.5 cm)	1" (2.5 cm)

Washer dimensions

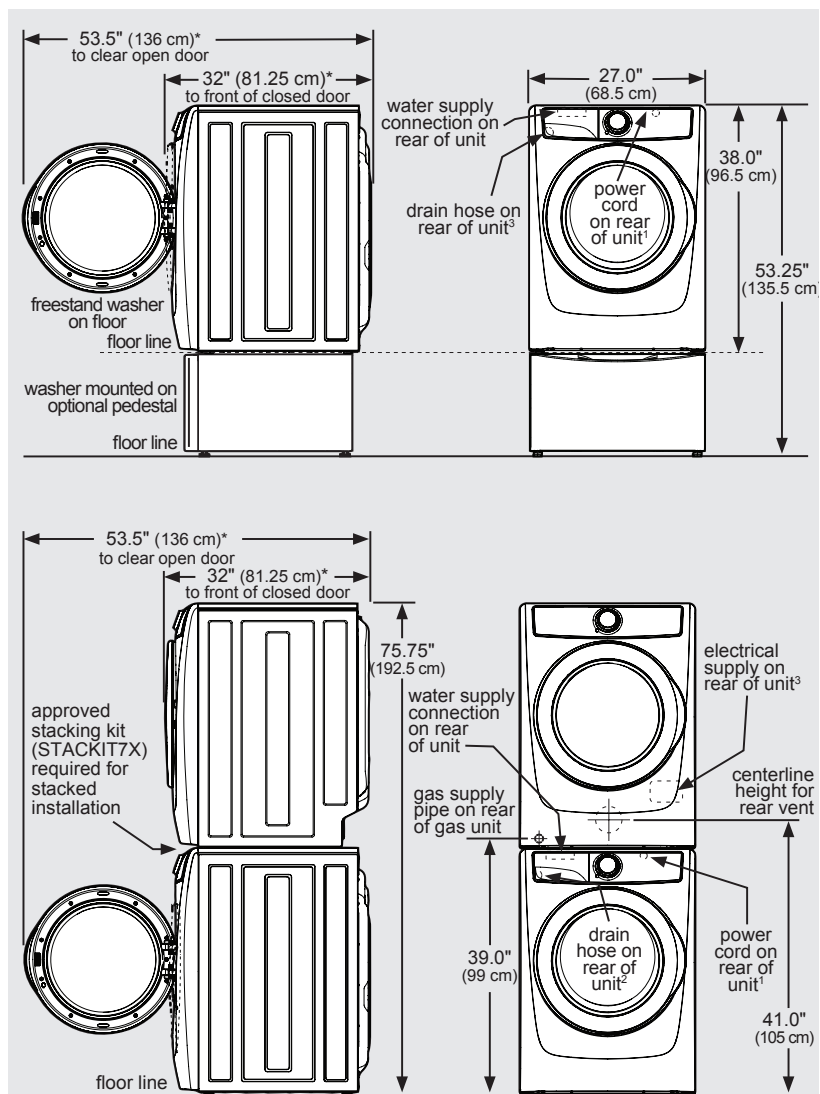

*Connection of water inlet hose on steam dryer adds 3/4 in. (2 cm) to installation depth.

¹Power supply cord length on washer approximately 60 inches (152.5 cm).

²Drain hose length on washer approximately 59 inches (150 cm).

³Power supply cord length on gas dryer or electric Canadian dryer approximately 60 inches (152.5 cm).

12 Installation

Unpacking the washer



WARNING

SUFFOCATION HAZARD

Dispose of the carton and plastic bags after the washer is unpacked. Children might use them for play. Cartons covered with rugs, bedspreads, or plastic sheets can become airtight chambers causing suffocation. Place all materials in a garbage container or make materials inaccessible to children.

1. Temporarily remove door tape.
2. Open washer door and remove everything from the drum.
3. Close door and reapply door tape.
4. Using a rug, blanket or piece of cardboard to protect the floor, carefully lay the washer on its back.

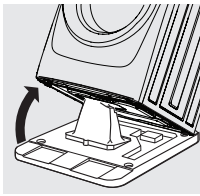
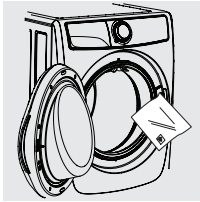

IMPORTANT

DO NOT place the washer onto its back without the shipping bolts.



CAUTION

EXCESSIVE WEIGHT HAZARD

To avoid back or other injury, have more than one person move or lift the washer.

5. Remove styrofoam base and shipping plug and set them aside.

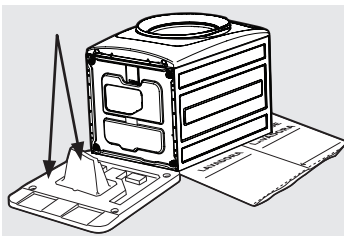

6. Carefully return the washer to an upright position.

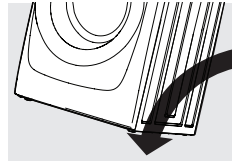

7. Carefully move the washer to within 4 feet (1 m) of its final location.



WARNING

ELECTRIC SHOCK HAZARD

Certain internal parts are intentionally not grounded and may present a risk of electrical shock if contacted during installation.

Do not contact the following parts while the appliance is energized

- Pump
- Drive motor
- Electrical control boards
- Water valves



IMPORTANT

Save styrofoam base and shipping plug for use to help prevent washer damage during any future moves.



IMPORTANT

DO NOT tip washer upside down onto its top or onto its right side for any reason.

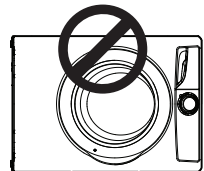
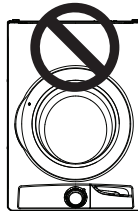

Removing shipping hardware

➔ IMPORTANT

Failure to remove shipping hardware completely could result in damage to the appliance, damage to your home, or unexpected washing results.

Save all shipping bolts and spacers for future use. If the washer is to be transported at a later date, the shipping hardware must be reinstalled to help prevent shipping damage

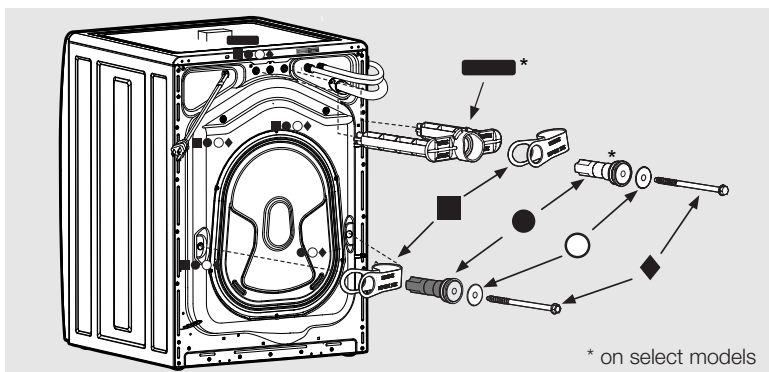

For 300 Series:

Remove all of the following:

- ◆ 4 BOLTS
- 4 SHIMS
- 4 BLACK SPACERS
- 3 P CLAMPS

For 400, 500, and 600 Series:

Remove all of the following:

- ◆ 5 BOLTS
- 5 SHIMS
- 4 BLACK SPACERS
- 4 P CLAMPS
- 1 WHITE SPACER*
- ▬ 1 SHIPPING FORK*

☰ NOTE

Rubber expansion material on spacers may need time to relax before they can be easily pulled through shipping hole.

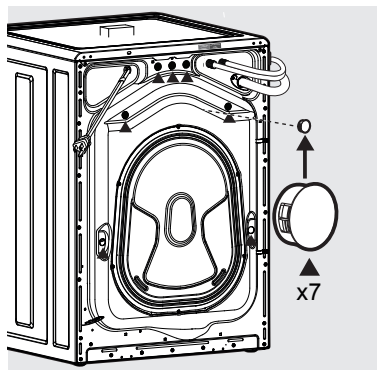

Installing hole plugs

Locate hole plugs in the small bag supplied with washer instruction guides. Insert them in the holes in the washer back panel where the shipping hardware has been removed.

14 Installation

Leveling the washer

Excessive noise and vibration can be prevented by properly leveling the washer.

1. For free standing installation and with the washer within 4 feet (1 m) of its final location, place a level on top of the washer.

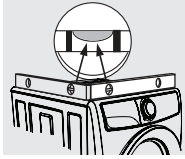

2. Use an adjustable wrench to adjust the leveling legs so the washer is level front-to-rear and side-to-side, and stable corner-to-corner.

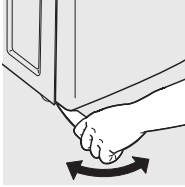

3. Press down on alternate corners and sides and feel for the slightest movement.

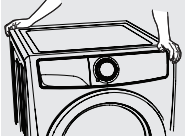

Adjust the appropriate leg(s) so the washer sits solidly on the floor on ALL four legs. Keep the leveling leg extension at a minimum for best performance of the washer.

NOTE

For pedestal installations, see additional installation instructions included with the pedestal.

Connecting the water

1. Run some water from the hot and cold faucets to flush the water lines and remove particles that might clog the water valve screens and to determine which faucet is hot and which is cold supply.

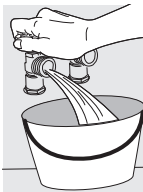

2. Check to ensure that the inlet hoses have the rubber washer firmly in place.

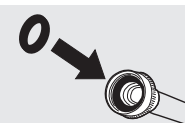

Rubber Washers
Must Be Present

**USE ONLY
NEW HOSES**

NOTE

Hoses are not included with washer purchase.

3. Connect the HOT inlet hose to the HOT inlet connection on the washer and the COLD inlet hose to the COLD inlet connection on the washer.

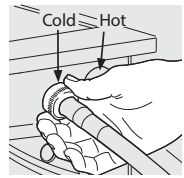

**Cold inlet shown
on left side (select
models only)**

IMPORTANT

The cold water inlet will have a blue cap cover on the inlet connection and the hot water inlet will have a red cap cover on the inlet connection. Additionally, depending on the model, the hot and cold inlet connections will be marked with either an adhesive label or markings directly on the unit to indicate which side is cold and which side is hot.

4. Tighten by hand until snug. Then tighten each supply connection another 2/3 turn with pliers.

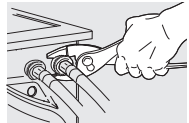

Do not cross thread or over-tighten these connections.

5. Connect the HOT inlet hose to the HOT water supply and the COLD inlet hose to the COLD water supply.

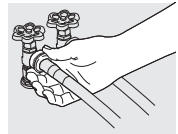

- Tighten by hand until snug. Then tighten each supply connection another 2/3 turn with pliers. **Do not bend, kink or pinch water inlet hoses.**

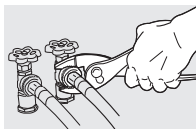

- Turn on the water and check for leaks.

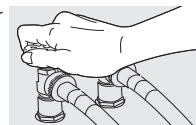

Connecting the drain

- Verify the anti-siphon disc is in place.
- Form a "U" shape on the end of the drain hose with the hose pointed toward the drain. Place the formed end in a laundry tub or a standpipe and secure the drain hose with the cable tie (provided in the enclosure package) to the standpipe, inlet hose, laundry tub, etc. so the hose does not pull out from the force of the water.

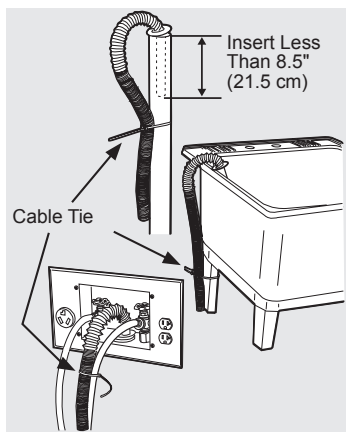

▶ IMPORTANT

Check to ensure the power is off at a circuit breaker/fuse box before plugging the power cord into an outlet.



NOTE

The standpipe inside diameter must be 1-1/4" (3.2 cm) minimum. There must be an air gap around the drain hose in the standpipe. A snug hose fit can cause a siphoning action.

Completing the installation

- Plug the power cord into a grounded outlet.



WARNING

ELECTRICAL SHOCK HAZARD

Improper connection of the equipment grounding conductor can cause an electrical shock that may result in serious injury or death. Check with a licensed electrician if you are in doubt as to whether the appliance is properly grounded.

See *Electrical System Requirements* and *Grounding Requirements* sections of this instruction for additional information.

- Turn on the power at a circuit breaker/fuse box.
- Carefully slide the washer to its final position. Recheck for level and rock corners for stability. See *Leveling the washer*. Remove and discard door tape.
- Run the washer through a complete cycle, checking for water leaks and proper operation.
- If you have any questions during initial operation, please review the *Troubleshooting* section before calling for service.
- Place these instructions in a location near the washer for future reference.



NOTE

A wiring diagram and technical data sheet are located under the washer top panel, on top of the detergent dispenser housing.

16 Installation

Reversing the door



NOTE

Door reversibility is available only on 400, 500, or 600 series models.



IMPORTANT

BEFORE YOU REVERSE WASHER DOOR:

1. Be sure you have adequate swing area before reversing door.
2. Gather your tools - including a screw driver with a #2 square bit and plastic knife (or small, flat prying tool that won't damage paint).
3. Protect flat work surface, such as top of washer or floor near washer, with a soft cloth or towel.
4. Be sure washer is unplugged from power source!

Tools needed for reversal:

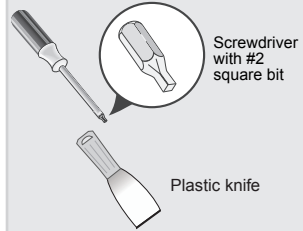

WARNING

ELECTRICAL SHOCK HAZARD

Failure to disconnect power source before servicing could result in personal injury or even death.

Removing door assembly

1. Completely open the door to expose all four hinge screws.
2. Remove all four hinge screws with #2 square bit driver. Save for reinstalling later.

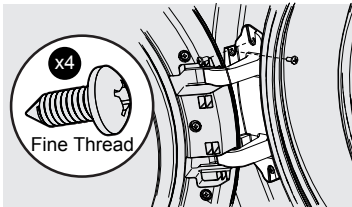

3. Hold the door with one hand supporting the handle area and one hand supporting the hinge. While supporting the door at the hinge, press firmly with the other hand until the locating pins on the back of the hinge plate dislocate from the front panel.

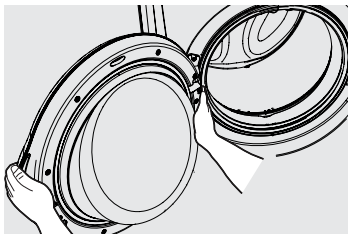

4. While supporting the door with one hand, pinch the tabs to release the plastic terminal cap from the hinge plate.



IMPORTANT

Take care not to pull the door away from the washer until you remove the wiring harness terminal cap.

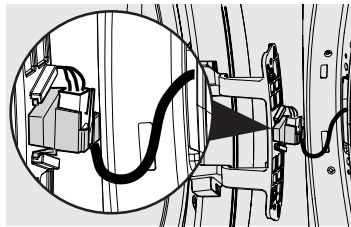

5. Set the door face down on a flat surface protected by soft cloth or towel.

6. Release wiring harness from retainer on plastic terminal cap. Then release terminal from terminal cap. Save the cap to reinstall later.

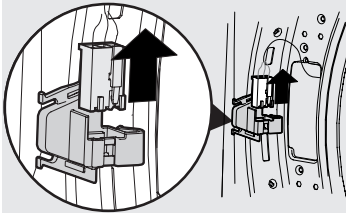

Removing door lock and plastic hole cover

1. Locate and remove both screws from door lock. Save screws for later.
2. Rotate the lock as you pull it out through the front panel. Take care not to pull too hard or too far as the lock is still attached to the wiring harness.

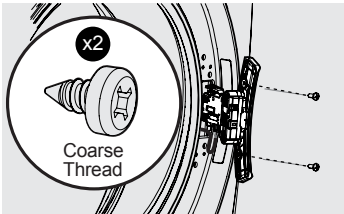

3. Disconnect the wiring harness terminal from the door lock. Set the door lock aside for reinstallation later.
4. Pry the bottom of the plastic hole cover upward to release it from the front panel. You may have to use a non-scratching plastic knife if you are unable to release it manually. Then, slide the cover down slightly and remove it from the front panel.

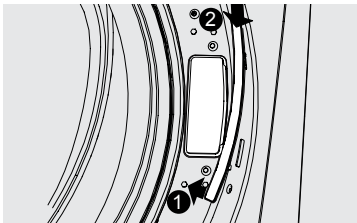

Reinstalling door lock and hole cover

1. Move the plastic cover to the other side of the front panel. Position the cover so the "hook" is at the bottom. Insert hook into lower slot, slide the cover down, and press upper retention tabs into opening until they snap into place.

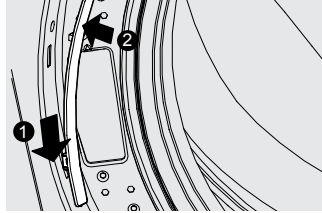

2. Insert wiring harness into door lock.
3. Insert door lock into front panel and reinstall door lock screws.

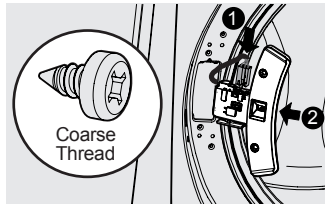

Reversing door assembly

1. Locate nine screws on inner door ring. Remove each and save for reinstallation later. Remove inner door (with hinge) and carefully set aside.

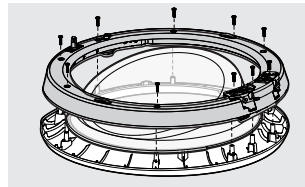

2. Lift door glass slightly and rotate 180 degrees, setting it back onto outer door.

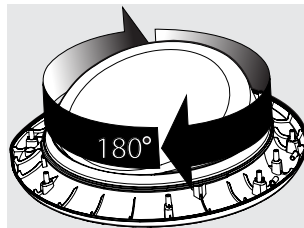

18 Installation

3. Make sure the alignment tabs reengage.

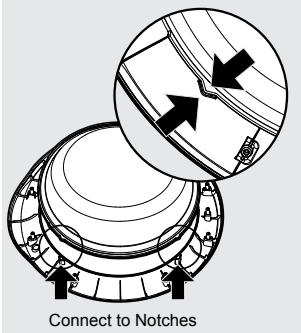

4. Reattach the inner door to the outer door using the nine screws removed earlier. See illustration, Step 1.
5. Check to verify that the scoop (wider section) of the door glass is situated at the BOTTOM of the door.

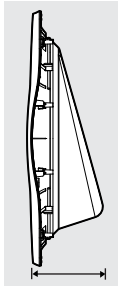

3. Insert hinge locating pins into the hole that were previously covered by the plastic hole cover. Press on the face of the hinge to snap the other locating pins into place.

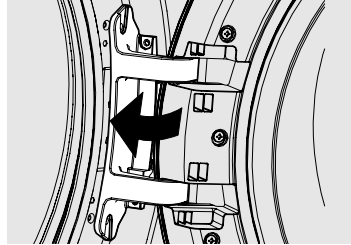

4. Reinstall all four screws removed earlier - two front screws first, then two side screws.

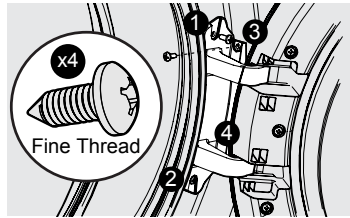

Reinstalling door assembly

1. Insert the wiring harness terminal into the terminal cap and wrap the harness into the harness retainer.

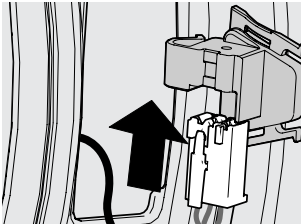

2. Slide terminal cap onto back of hinge plate until tabs snap into place.

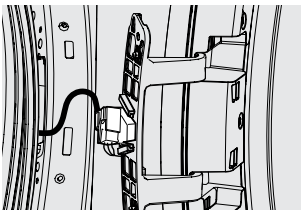

Verify reversed door operation

1. Test door for free, smooth swinging operation and secure latching when closed.
2. Verify inner door glass is in the correct orientation with the "scoop" at the bottom.

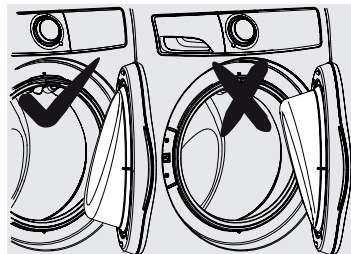

3. Plug in washer and close the door. Test correct door lock operation by starting a test cycle: lock should engage, and door should not be able to be opened until cycle is paused or canceled.

Model series

300 SERIES

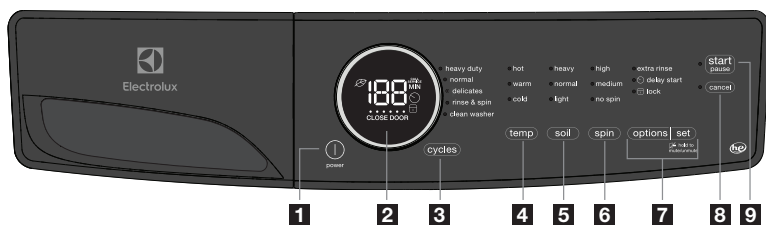

400 SERIES

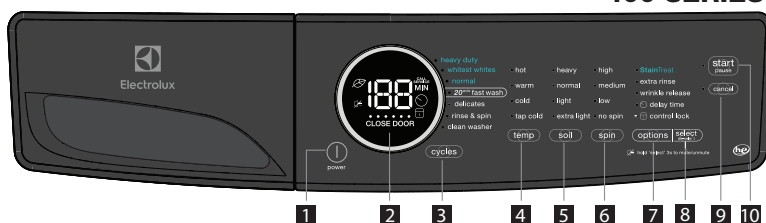

500 SERIES

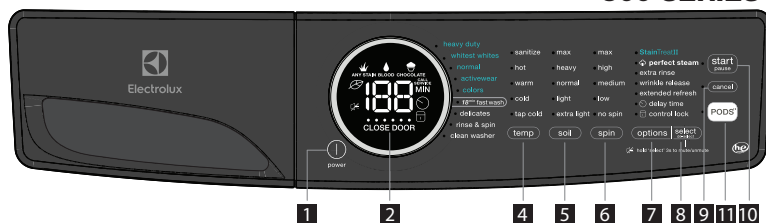

600 SERIES

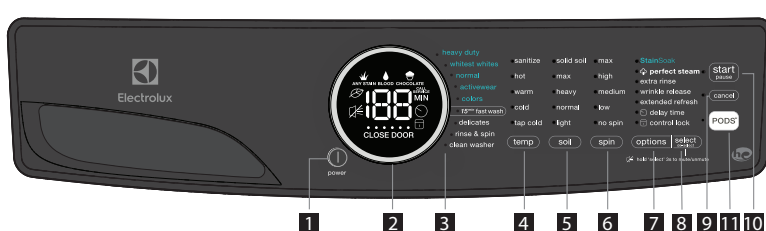

- | | | | |
|------------------|---------------|--------------|--------------------------|
| 1 power | 4 temperature | 7 options | 10 start |
| 2 LED display | 5 soil level | 8 set/select | 11 PODS® (select models) |
| 3 cycle selector | 6 spin speed | 9 cancel | |

This manual covers many models and not all cycles, options, or features listed are available on every model. Consoles shown above for reference only. Your model may differ.

20 Controls and Settings

Settings chart - 300 series washer



These temperature, spin speeds, soil levels and options are available with the following cycles:

CYCLE SELECTIONS

heavy duty	normal	delicates	rinse & spin	clean washer
------------	--------	-----------	--------------	--------------

temp

hot	✓	✓		
warm	✓	✓	✓	
cold	✓	✓	✓	■

soil

heavy	✓	✓		
normal	✓	✓	✓	
light		✓	✓	

spin

high	✓	✓		✓
medium	✓	✓	✓	✓
no spin		✓	✓	✓

options

extra rinse	✓	✓	✓	✓
delay start	✓	✓	✓	✓
control lock	✓	✓	✓	✓
chime	✓	✓	✓	✓

**NO OPTIONS AVAILABLE WITH THIS CYCLE.
DO NOT LOAD ANY ITEMS IN DRUM DURING SYSTEM
CLEAN CYCLE.**

CYCLE SETTINGS

CYCLE OPTIONS

✓ = Available selections. ◻ = Factory presets. ◼ = Non-modifiable presets.

Settings chart - 400 series washer

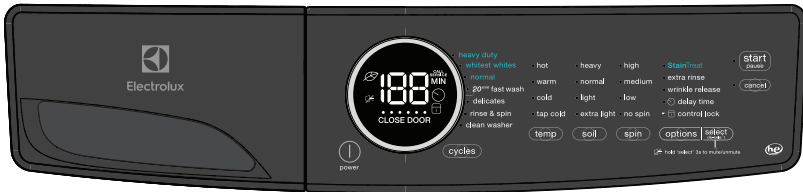

These temperature, spin speeds, soil levels and options are available with the following cycles:

CYCLE SELECTIONS

heavy duty	whitest whites	normal	delicates	20 ^{min} fast wash	rinse & spin	clean washer
------------	----------------	--------	-----------	-----------------------------	--------------	--------------

temp

hot	✓	✓	✓			
warm	✓	✓	✓	✓	✓	
cold	✓	✓	✓	✓	✓	
tap cold	✓	✓	✓	✓		✓

soil

heavy	✓	✓	✓			
normal	✓	✓	✓	✓		
light			✓	✓	✓	
extra light			✓	✓	✓	

spin

high	✓	✓	✓		■	✓
medium	✓	✓	✓	✓		✓
low		✓	✓	✓		✓
no spin		✓	✓	✓		✓

options

StainTreat	✓	✓	✓			
extra rinse	✓	✓	✓	✓		✓
wrinkle release	✓	✓	✓	✓		
delay time	✓	✓	✓	✓	✓	✓
chime	✓	✓	✓	✓	✓	✓
control lock	✓	✓	✓	✓	✓	✓

CYCLE SETTINGS

CYCLE OPTIONS

NO OPTIONS AVAILABLE WITH THIS CYCLE.
DO NOT LOAD ANY ITEMS IN DRUM DURING SYSTEM CLEAN CYCLE.

✓ = Available selections. ◻ = Factory presets. ■ = Non-modifiable presets.

22 Controls and Settings

Settings chart - 500 series washer

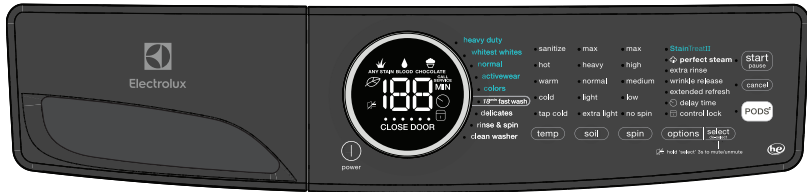

These temperature, spin speeds, soil levels and options are available with the following cycles:

CYCLE SELECTIONS

heavy duty	whitest whites	normal	activewear	colors	delicates	18 ^{min} fast wash	rinse & spin	clean washer
------------	----------------	--------	------------	--------	-----------	-----------------------------	--------------	--------------

temp

sanitize	✓	✓	✓					
hot	✓	✓	✓					
warm	✓	✓	✓	✓	✓	✓	✓	
cold	✓	✓	✓	✓	✓	✓		
tap cold	✓	✓	✓					✓

soil

max	✓	✓	✓	✓	✓			
heavy	✓	✓	✓	✓	✓			
normal	✓	✓	✓	✓	✓	✓		
light			✓	✓	✓	✓	✓	
extra light			✓	✓	✓	✓	✓	

spin

max	✓	✓	✓	✓	✓	■	✓	✓
high	✓	✓	✓	✓	✓			✓
medium	✓	✓	✓	✓	✓	✓	✓	✓
low		✓	✓	✓	✓	✓	✓	✓
no spin		✓	✓	✓	✓	✓	✓	✓

options

StainTreatII	✓	✓	✓	✓	✓			
perfect steam™	✓	✓	✓	✓	✓		✓	
extra rinse	✓	✓	✓	✓	✓	✓	✓	✓
wrinkle release	✓	✓	✓	✓	✓	✓		
extended refresh	✓	✓	✓	✓	✓			
delay time	✓	✓	✓	✓	✓	✓	✓	✓
chime	✓	✓	✓	✓	✓	✓	✓	✓
control lock	✓	✓	✓	✓	✓	✓	✓	✓
PODS®	✓	✓	✓	✓	✓	✓	✓	✓

NO OPTIONS AVAILABLE WITH THIS CYCLE. DO NOT LOAD ANY ITEMS IN DRUM DURING SYSTEM CLEAN CYCLE.

✓ = Available selections. □ = Factory presets. ■ = Non-modifiable presets.

Settings chart - 600 series washer



These temperature, spin speeds, soil levels and options are available with the following cycles:

CYCLE SELECTIONS										
heavy duty	whitest whites	normal	activewear	colors	delicates	15min fast wash	rinse & spin	clean washer		

CYCLE SETTINGS	temp										NO OPTIONS AVAILABLE WITH THIS CYCLE. DO NOT LOAD ANY ITEMS IN DRUM DURING SYSTEM CLEAN CYCLE.	
	sanitize	✓	✓	✓								
	hot	✓	✓	✓								
	warm	✓	✓	✓	✓	✓	✓	✓				
	cold	✓	✓	✓	✓	✓	✓	✓				
	tap cold	✓	✓	✓	✓	✓	✓		✓			
	soil											
	solid soil	✓	✓	✓	✓	✓						
	max	✓	✓	✓	✓	✓						
	heavy	✓	✓	✓	✓	✓						
normal	✓	✓	✓	✓	✓	✓						
light			✓	✓	✓	✓	✓					
spin												
max	✓	✓	✓	✓	✓		✓	✓				
high	✓	✓	✓	✓	✓			✓				
medium	✓	✓	✓	✓	✓	✓		✓				
low		✓	✓	✓	✓	✓		✓				
no spin		✓	✓	✓	✓	✓		✓				
options												
StainSoak	✓	✓	✓	✓	✓							
perfect steam™	✓	✓	✓	✓	✓		✓					
extra rinse	✓	✓	✓	✓	✓	✓		✓				
wrinkle release	✓	✓	✓	✓	✓	✓						
extended refresh	✓	✓	✓	✓	✓							
delay time	✓	✓	✓	✓	✓	✓	✓	✓				
chime	✓	✓	✓	✓	✓	✓	✓	✓				
control lock	✓	✓	✓	✓	✓	✓	✓	✓				
PODS®	✓	✓	✓	✓	✓	✓	✓	✓				

✓ = Available selections. ◻ = Factory presets. ◼ = Non-modifiable presets.

24 Controls and Settings

Cycle selection

Press the **power** button to turn on the unit. Then, turn the cycle selector in either direction or press the cycles button (dependent on model) to scroll to the desired cycle. The indicator light for that cycle will be illuminated.

The estimated cycle time will appear on the LED display and indicator lights adjacent to the default settings (water temperature, final spin speed, and soil level) will illuminate for the cycle selected. See *Washer Settings Chart* for default settings for each cycle.

Cycle settings and cycle options can be changed using the **temp**, **spin** and **soil** buttons. See *Cycle Settings* and *Cycle Options* for detailed directions and descriptions of available settings.

To change the cycle once the cycle has begun, press **cancel**, select a new cycle, and press **start** again.



NOTE

Turning the cycle selector knob without canceling the cycle first, will not change the cycle.

To stop the cycle, press **cancel**.



NOTE

Using PODS® setting may increase **fast wash** time by several minutes.



NOTE

For **spin only** cycle deselect **extra rinse**. For **drain only** cycle select **no spin**.

See *Cycle Options* for rinse options and *Cycle Settings* for spin settings.



For best results

Follow the fabric care label instructions on items to be washed.



NOTE

If the LED display shows 3 dots (●●●) cycling one to the next after the laundry cycle is complete, then the appliance is updating its software. Please allow 3 minutes for the update to be complete.

Cycles

LOAD	LOAD TYPE	CYCLE DESCRIPTION
heavy duty	Large heavily soiled loads	<ul style="list-style-type: none">• longer agitation• aggressive cleaning motion• higher temperatures
whitest whites	White loads	<ul style="list-style-type: none">• longer agitation• higher temperatures
normal	Mixed loads, cotton	<ul style="list-style-type: none">• moderate agitation• moderate cleaning motion• most energy efficient"
activewear	Highly solid lightweight synthetic apparel	<ul style="list-style-type: none">• longer agitation• mild cleaning motion• extra rinse
colors (select models)	Lightly soiled dark or dyed fabrics	<ul style="list-style-type: none">• mild cleaning motion• lower temperatures"
fast wash (varies by model) 15/18/20 min.	Small lightly soiled loads (3-5 pieces)	<ul style="list-style-type: none">• aggressive cleaning motion• extra rinse
delicates	Small lightly soiled loads (delicate fabrics)	<ul style="list-style-type: none">• shorter agitation• gentle cleaning motion• lower temperatures• lower spin speeds
rinse & spin	Rinse and spin only (cold rinse or add fabric softener)	<ul style="list-style-type: none">• cold temperature
clean washer	See "Care and Cleaning" section of the manual	

Cycle settings

Washing temperature

The appropriate washing temperature will automatically be indicated for the cycle selected. To change the preset temperature, press the **temp** button to scroll to the desired setting. Select a wash water temperature according to fiber content, colorfastness and soil level.

To protect your fabrics, not all temperatures are available with every cycle. If a temperature is not appropriate for the cycle, it cannot be selected and will not be lit by pressing the **temp** button.

The temperature selected for the cycle will be remembered and recalled each time that cycle is selected in the future.

All wash water temperatures are automatically regulated to maximize detergent effectiveness and improve washing performance. The water heater setting and its distance from the washer, water usage in other parts of the home, and seasonally low ground water temperature in some geographic areas can affect water temperature.

sanitize (on select models)

Use the sanitize setting to clean and sanitize heavily soiled, colorfast fabrics including towels, bedding, cloth diapers, and children's clothing.

It is recommended that you set your water heater to 120°F (49°C) or higher to ensure proper performance during this cycle. If the setting is lower or the load is extra large, the cycle time may be extended.

When used with the **heavy duty** and **whitest whites** cycles, the **sanitize** setting will kill 99.9% of bacteria with no carryover of bacteria between loads. No bleach or harsh chemicals are needed, but higher temperatures are required. Please check fabric care labels to prevent damage.



NOTE

The **heavy duty** and **whitest whites** with **sanitize** setting cycles have been designed to meet the requirements of NSF P172 protocol for sanitization efficacy.



NSF Protocol P172
Sanitization Performance of Residential and Commercial, Family-Sized Clothes Washers



NOTE

If the voltage at your outlet is under 110v, the internal heater may not adequately heat the wash water. If the cycle is interrupted while the water is heating, the final temperature of the wash water may be lower and sanitation may be reduced.

The wash water is heated by an internal boost heater to a maximum of 152°F (67°C) as the load tumbles. Cold water is added to cool down the load prior to drain and spin.

As a precaution, the washer door remains locked when the water temperature reaches 130°F (55°C)



NOTE

If the wash cycle is paused or cancelled while the internal drum temperature is above 130°F (55°C), the door will remain locked until it cools. You may manually perform a rinse & spin cycle to cool the internal temperature sooner.

hot

Use this setting for heavily soiled white or colorfast cottons and blends.

warm

Use this setting for normally soiled white or colorfast cottons or blends.

cold

Some warm water will automatically blend with cold tap supply to achieve a precise cold. Use this setting for lightly soiled non-colorfast items, knits, delicates, and hand washables.

tap cold (on select models)

Wash and rinse temperatures are equivalent to temperature of cold tap supply. Use this selection for fabrics and colors that are prone to dye transfer. For use with cold water detergents.



NOTE

The washer will ALWAYS use a small amount of HOT water to dissolve the pack when the **PODS®** option has been selected.

Soil level

Adjust the wash time based on the soil level of each load. **Solid soil** (on select models), **max** (on select models), **heavy**, **normal**, **light** and **extra light** (on some models) soil levels are available.

26 Controls and Settings

Spin speed

Max (on select models), **high**, **medium** and **low** (on some models) spin speeds are available for each cycle. The spin speed and/or duration of final spin vary from model to model and cycle to cycle.

Increasing the spin speed will extract more water, decrease drying time and conserve energy. Decreasing the spin speed will reduce wrinkling.

Select **low** spin speed (on some models) to gently spin items that should be line dried.

Use **no spin** to omit the final spin at the end of the cycle. The load will be very wet. Remove items from the wash drum to drip dry or select a spin only cycle to remove excess water at a more convenient time.

Cycle options

The default options for each cycle will automatically be chosen when a cycle is selected. To protect fabrics, not all options are available for all cycles. If an option is not available for a cycle, the indicator will not light.

Selecting options

Press the **option** button to scroll through the options until the indicator light for the desired option flashes, then press **select**. The indicator light will illuminate when the option has been selected. Follow the same steps to deselect an option. The indicator light will turn off when the option is deselected.



NOTE

If changes to the settings or options are attempted after the cycle starts, you will hear several beeps when the buttons are pressed. To change settings or options, press **start/pause**, make the new selections and press **start/pause** again.

All settings or options selected for the cycle, except **sanitize** (on select models), **perfect steam™** (on select models), and stain treatment options, will be remembered and recalled each time that cycle is selected in the future. To return to factory settings, press and hold **soil** and **options** buttons at the same time and hold for **3** seconds until the confirmation signal sounds. To prevent unintentional

and accidental exposure of delicate material to excess heat or unexpected steam, the **sanitize**, **perfect steam™** and all stain treatment options will need to be reselected each time.

Stain treatment options (on select models)



Your washer is equipped with powerful stain treatment tools. Depending on your model, use one of the options below to deal with tough stains on your garments. See step 5 in the *Operating Your Washer* section in this guide for details on adding stain additives to the dispenser.

StainTreat (400 series washer)

Select this option to add a short initial wash period to available cycles using the stain treatment additives in the **stain soak/treat** compartment. After the stain wash phase, the load will automatically advance to the main wash cycle.

StainTreatII (500 series washer)

Select this option when available and rotate the cycle selector to rotate through the stain types below. Stain treatment and main detergent will recirculate in the agitating load for approximately 20 minutes and then the washer will advance to the main wash cycle.

- **Any Stain**  Recirculating wash solution will be heated by boost heater.
- **Blood**  Recirculating wash solution will NOT be heated by boost heater to prevent setting blood stains.
- **Chocolate**  Stain wash time is extended with additional heating by boost heater.

StainSoak (600 series washer)

Similar to **StainTreatII** above with the added feature of detergent/treatment mixing with **SmartBoost** pump technology before the **Stain** washing phase.

perfect steam™ (on select models)

Select this option to add approximately 20 minutes of tumbling in steam.



NOTE

- Steam may not necessarily be visible inside drum during a steam wash cycle.
- Steam may not be present during entire steam wash cycle.



IMPORTANT

- If steam is selected, rinse temperatures will be elevated.
- If the wash cycle is paused or cancelled during a steam cycle, the door will remain locked until it cools. You may manually perform a rinse & spin cycle to cool the internal temperature sooner.
- During a steam cycle, steam exiting from the rear vent of the washer is normal and not cause for alarm.

Wash cycle options

extra rinse

Use this option when additional rinsing is desired to remove excess dirt and detergent. It is recommended for heavily soiled loads or if household members have sensitive skin.

wrinkle release (on select models)

After the final spin, the washer will perform a “dry” agitation to loosen the garments from the side of the drum.

extended refresh (on select models)

Select **extended refresh** if you will be unable to remove the load right after the cycle is complete. The washer recognizes the load has sat too long and will do a rinse and spin to keep the load fresh for up to 12 hours. When you are ready to remove the load during the **extended refresh** segment, you must press **cancel** to end the cycle and open the door.

PODS® (on select models)

Select this option when using a detergent pack in a model equipped with a **PODS®** button (on select dispenser only). This option will divert the flow of water to the detergent pack compartment optimizing the detergent pack performance.

Control options

control lock

To lock the controls between cycles, scroll to the control lock option and press **select**. The control lock icon will show on the LED display. To unlock the controls scroll to the control lock option again and press **select**. Use this feature to reduce the likelihood of accidental operation by children. **Washer cycles will not run when control lock is activated.**



delay time

Use **delay time** to delay the start of the washing cycle from 30 minutes to 12 hours. To turn on the delay time option, press **options** to scroll to the **delay time** icon and press **select**. Use the **cycles** button (300/400 models) or turn the cycle selector (500/600 models) to select the desired delay time and press **start**. The **delay time** icon will illuminate on the LED display to indicate the **delay time** option is activated. The time will begin counting down on the LED display once the washer **start/pause** button has been pressed.



Chime

A signal will sound at the end of each cycle (and periodically during **extended refresh**) if option is activated.

To mute or unmute the chime, **press and hold the select button for 3 sec.**



hold 'select' 3 s to mute/unmute

Other features

LED display



Icons may vary according to model.

The estimated total cycle time will be displayed when the cycle is selected. The time may increase if water pressure is low, oversudsing occurs or the load becomes unbalanced. The approximate time remaining will be displayed during the cycle. As the washer progresses through the cycle phases, the row of cycle phase indicators lights up under the cycle time. **The eco, control lock, close door, mute (some models), and delay time** will also appear on this LED display.

28 Controls and Settings

Eco indicator

The **eco** symbol will light up on the LED display to indicate that the selected combination of temperature, spin speed and options are eco friendly.



Oversuds protection

A situation where oversudsing has been detected by the washer will result in the washer requiring additional rinses until the suds have been cleared. Each extra rinse the washer performs to clear the suds will add approximately 5 minutes to the cycle duration. The LED will display "SU" followed by "dS" and then the remaining cycle time (0 min) for 60 seconds and then repeat. Press **cancel** to turn off the alert message. The washer will continue to perform rinse cycles until suds are removed.



Reversed Hose Detection

If condition is detected where the inlet hoses have been installed incorrectly (hot supply to cold inlet and cold supply to hot inlet), the washer will alert you. The LED will display "HO" followed by "SE" and then the remaining cycle time (0 min) for 60 seconds and then repeat. Acknowledge the reversed hose condition by pressing the cancel button. Shut off each water supply valve and attach each supply hose to the correct inlet connection on the washer.



Drum light (on select models)

The drum light will come on whenever the door is opened to illuminate the drum during loading and unloading. Closing the door turns off the light. The drum light will automatically turn off if the door is left open more than 3 minutes.

Reversible door (on select models)

Your washer may be equipped with a reversible door. The door can be hinged on the right or left side.



NOTE

For step-by-step instructions on door reversal, refer to the Installation sections of this guide.

Trapped item detection

If an item is detected to be trapped between the door and the door gasket, the washer will pause the cycle and play an alert chime. The LED will display a loop of "CLEAR door" as shown below until the cancel button is pressed. Press the cancel button to unlock the door and remove the trapped item, then close the door and restart the cycle.

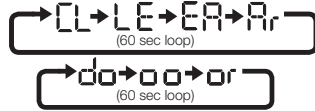

Door stand ventilation

Help prevent odor buildup and reduce humidity between washes by utilizing your washer's door stand ventilation feature. Open the door, locate the stand below the door latch and rotate the stand counter-clockwise to unlock it.



NOTE

If unable to rotate the stand by hand, a coin or flat blade screw driver can be used.

The stand is spring loaded and will extend. Rotate it clockwise to lock in the extended position.

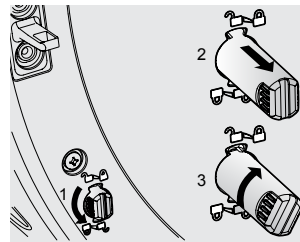

To disengage the stand, rotate to unlock, push the stand in and rotate to lock position.



NOTE

If door stand will not turn to locked position, fully turn it to unlock position and try to lock again.

Operating the washer



WARNING

To reduce the risk of fire, electric shock or injury to persons, read the **Important Safety Instructions** in this *Use & Care Guide* before operating your washer.



WARNING

RISK OF INJURY



DO NOT wash water resistant and water repellent clothing or other materials. Failure to follow these instructions may result in an abnormal vibrating and out-of-balance condition that could result in physical injury, property damage, and/or appliance damage.



CAUTION

ENTRAPMENT and TIP-OVER HAZARD

DO NOT leave the door open if there are small children or pets present. An open door could entice children to hang on the door or crawl inside the washer. If there are no small children present, you may leave the door ajar to prevent odor build up.

STEPS	TIPS	IMPORTANT
<p>1. Sort laundry into loads that can be washed together.</p> 	<ul style="list-style-type: none"> • Sort by recommended cycle and water temperature. • Separate white, light, and colorfast items from dark and non-colorfast items. • Separate items that shed lint from items that attract lint. Casual, synthetic, knit, and corduroy items will pick up lint from towels, rugs, and bedspreads. • Separate heavily soiled items from lightly soiled items. • Separate lacy, sheer, loosely knit, or delicate items from durable items. 	<p>DO NOT machine wash items containing fiberglass. Small particles of fiberglass left in drum may transfer to fabrics in other loads and cause skin irritation and/or damage to fabrics.</p> <p>DO NOT wash water resistant and water repellent type clothing or other materials</p>
<p>2. Prepare items for washing.</p> 	<ul style="list-style-type: none"> • Empty pockets. • Brush off lint and dirt. Shake out rugs and beach towels. • Close zippers, fasten hooks, button buttons, and tie strings/sashes. Remove non-washable trims and ornaments. • Place delicate and small items (bras, hosiery, etc.) in a mesh bag (not included). 	<p>Mend rips and tears to prevent further damage during washing.</p> <p>Turn knit items inside out to prevent pilling.</p>
<p>3. Pretreat stains and heavy soil.</p>	<p>See stain treatment function in <i>Cycle Options</i> for your particular model or <i>Stain Removal Guide</i> for more information.</p>	
<p>4. Add laundry load to wash tub.</p>	<ul style="list-style-type: none"> • Combine large and small items in a load. Load large items first. • Large items should not be more than half the total wash load. • Washing single items is inefficient and may cause an out-of-balance load. Add 1 or 2 similar items to help balance load. • Wash single heavy items (comforter, sleeping bag, etc.) separately. • The washer can be fully loaded, but the items should not be tightly packed. The door should close easily. 	<p>DO NOT overload the washer.</p> <p>DO NOT WASH: Water resistant and water repellent clothing or other materials.</p>

30 Operating Instructions

STEPS	TIPS	IMPORTANT
5. Add wash products to dispenser.	<ul style="list-style-type: none"> • Water conditioners, detergent boosters and enzyme products may be added with detergent. • See <i>Adding Laundry Products</i> for detailed information on the use of the product dispensers. • See <i>Adding Laundry Products</i> for detailed information on the use of various wash products (detergent, bleach, stain treatment, fabric softener, etc). 	<p>Follow manufacturer's instructions and recommendations when using wash products.</p> <p>Open and close the dispenser drawer slowly. Closing the drawer too quickly could result in early dispensing of the bleach or fabric softener.</p>
6. Select the cycle and settings for the load.	<ul style="list-style-type: none"> • See <i>Cycle Selection, Cycle Settings, and Cycle Options</i> for detailed descriptions of cycle controls. • See <i>Cycle Setting Charts</i> to determine which settings are available for each cycle. • To provide the best care, not every setting or option is available with every cycle. If a setting or option is not available for the cycle selected, the indicator will not light. 	<p>Follow fabric care label instructions on items to be washed.</p> <p>Make sure that the PODS® option is selected when using models that have a separate detergent pack compartment. See <i>Adding Laundry Detergent to the Adaptive Dispenser™</i></p>
7. Start the washer.	<ul style="list-style-type: none"> • Close the door and press start/pause. The washer will not operate with the door open. "CLOSE DOOR" will be displayed as a reminder to close the door. • To add a forgotten item to the washer any time during the wash portion of the cycle, press start/pause. When the door unlocks, open the door, add the item, close the door and press start/pause to resume cycle. • To change settings or options after the cycle has begun, press start/pause, change the settings, and then press start/pause. If the cycle is not paused first, the unit will emit several beeps when the buttons are pressed but no changes to the cycle will be applied. • To change the cycle once the cycle has begun, press cancel to cancel the cycle, select the new cycle, and press start/pause to begin the new cycle. Changing a cycle selection without cancelling the current WILL NOT change the cycle. • To cancel a cycle, press cancel. • A signal will sound at the end of the cycle if the chime option is not set to mute. 	<p>DO NOT force door open. As a safety measure, the door will automatically lock during the entire wash cycle. Pause or cancel the wash load to unlock the door.</p> <p>If the cycle is interrupted during spin, the door lock will not release until the tub has stopped spinning.</p> <p>If the water level is above the bottom of the door opening/flexible door gasket, the lock will not release.</p>
8. Remove items from washer when cycle has ended.	<ul style="list-style-type: none"> • Remove items when the cycle ends and place in dryer, line dry or dry flat as directed on the fabric care label. 	<p>Excess wrinkling, color transfer or odors may develop in items left in the washer after the cycle has ended.</p>

Adding laundry products

Laundry product dispensers

Product dispenser - three compartment dispenser (300 Series)

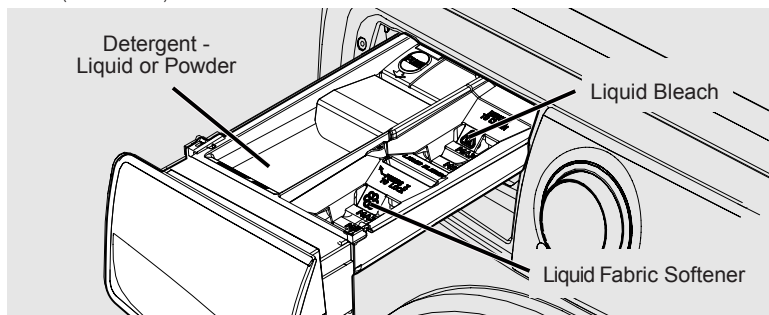

Product dispenser - Adaptive Dispenser™ (400, 500, and 600 Series)

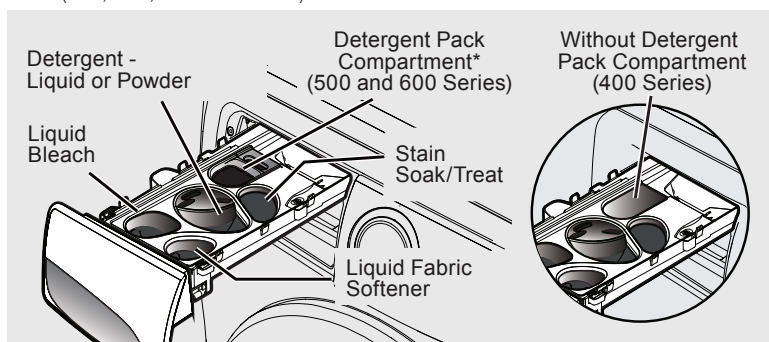

*Max. 2 packs per load

Detergent, stain treatment (on select models), liquid chlorine bleach and liquid fabric softener will be dispensed at the proper times in the cycle.

Use the cap or scoop provided by the detergent manufacturer to measure the amount recommended. Detergent dosage may need to be adjusted for water temperature, water hardness, load size and soil level.



IMPORTANT

Open and close the dispenser drawer slowly. Closing the drawer too quickly could result in early dispensing of the bleach or fabric softener.

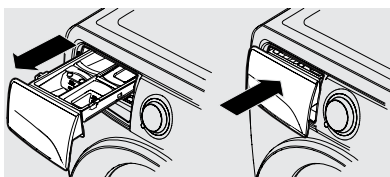

For best results

Use a low-sudsing, high efficiency detergent to prevent oversudsing in front load washers. Look for this symbol on the detergent label: 

32 Operating Instructions

Adding laundry detergent to the three compartment dispenser

Liquid or powder detergent

- Use the cap or scoop provided by the detergent to add recommended amount of detergent.
- Amount of detergent may need to be adjusted for water temperature, water hardness, load size, and soil level. Follow manufacturer's instruction.

In a three compartment dispenser use either liquid or powder detergent. **DO NOT** mix both.



IMPORTANT

DO NOT mix liquids and powders.



IMPORTANT

DO NOT exceed MAX fill line.

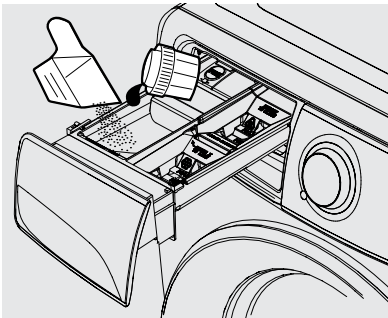

IMPORTANT

DO NOT add detergent packs into the three compartment dispenser. Detergent packs should be added directly into the drum.



CAUTION

Keep detergent packs away from children.

Adding laundry detergent to the adaptive dispenser™

Liquid detergent

- Use the cap or scoop provided by the detergent to add recommended amount of detergent to the detergent compartment. Pour directly into the detergent cup, not over the blue cover.
- Amount of detergent may need to be adjusted for water temperature, water hardness, and load size. Follow manufacturers instructions.

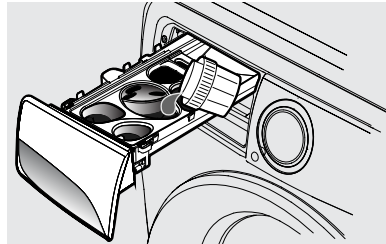

IMPORTANT

Pour liquid into the liquid detergent cup. **DO NOT** pour over the blue cover. **DO NOT** exceed MAX fill line.

Powder detergent

- Remove the liquid detergent cup and blue cover before adding powder detergent.
- Add powder detergent directly to the powder detergent compartment.

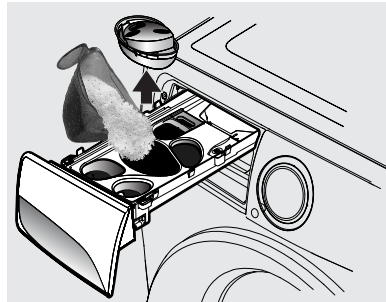

IMPORTANT

Save the liquid detergent cup and blue cover for future use. **DO NOT** discard it while you are using powder detergent. **DO NOT** exceed MAX fill line.

Detergent pack

For 300 and 400 series models

Add detergent pack directly to the empty drum **BEFORE** placing laundry into the unit.

- **DO NOT** place detergent packs directly into the detergent drawer. The gel coating may cause the detergent drawer to become clogged.

For 500 and 600 series models

Add the recommended quantity of high efficiency detergent packs to the detergent pack compartment in the dispenser.

- **DO NOT** place more than two packs into the dispenser.
- When using the **fast wash** cycle, only one detergent pack should be used.



CAUTION

Keep detergent packs away from children.



IMPORTANT

- When using the detergent pack compartment, make sure to select the **PODS®** option before starting the load.
- Once the **PODS®** option has been chosen, the washer will retain the **PODS®** setting until manually changed.
- The washer will **ALWAYS** use a small amount of **HOT** water to dissolve the pack when the **PODS®** option has been selected.

PODS®

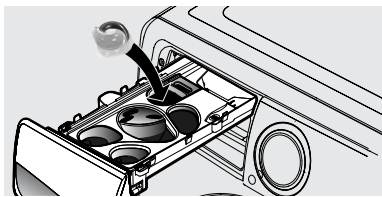

NOTE

From time to time you may see water in the dispenser. This is part of the normal operation of the washer.

Adding other wash products

- Color-safe bleach, water conditioner, detergent booster and enzyme products may be added with detergent.

- Put liquid products in the **Main Wash - liquid detergent** compartment or powder products in the **Main Wash - powder detergent** compartment.



IMPORTANT

DO NOT mix liquids and powders.

Stain treatment (on select models)

- For heavily soiled or stained loads, select the **Stain** option (on select models only - StainTreat, StainTreatII, or StainSoak) and add the recommended amount of detergent or stain treatment to stain soak/ treat compartment (on select models).
- See *Cycle Options* for information about Stain options for your model.
- See *Stain Removal Guide* in this instruction for additional suggestions.



IMPORTANT

Use of multi-product (detergent plus softener) sheets or color-absorbing sheets **NOT** recommended. They could disable your machine and result in unwarranted repair costs.

Liquid chlorine bleach

- If desired, add liquid chlorine bleach to the compartment labeled **Liquid Bleach** and marked with this symbol: .
- **DO NOT** fill above the **MAX** fill line.
- Add color-safe bleach with detergent.



IMPORTANT

To prevent fabric damage, **DO NOT** overfill the **Liquid Bleach** compartment or pour bleach directly onto the load.

Liquid fabric softener

- If desired, pour the recommended amount of liquid fabric softener into the compartment labeled **Fabric Softener** and marked with this symbol: .
- **DO NOT** fill above the **MAX** fill line.



NOTE

To prevent staining, **DO NOT** overfill **Fabric Softener** compartment or pour liquid fabric softener directly on wash load.

- Use of a fabric softener-dispensing ball is not recommended in front load washers.

34 Normal Operating Sounds

Normal operating sounds

You may or may not hear the following sounds from your new washer:

- A. DRAIN HOSE** The washer has a flexible drain hose to carry water from the washer to the stand pipe of your home. You will hear water flowing into your stand pipe. This is a normal part of the operation of the washer.
- B. WATER VALVES/DISPENSER** As water enters the dispenser system, it is common to hear a water flowing sound. This normal sound will vary slightly based on the water pressure in your home.
- C. DOOR LOCK** Your washer is equipped with a door lock with an electric solenoid. There will be a clicking sound as the washer door is being locked or unlocked.
- D. DRAIN/RECIRCULATION PUMPS** Your washer is equipped with multiple high velocity system pumps. It is normal to hear humming and gurgling sounds as water is either pumped from the washer during the drain phase or recirculated during the prewash and wash phases. Both of these sounds are normal and indicate that your pump is functioning correctly.
- E. HIGH SPEED MOTOR** A powerful motor is used to drive the drum to high spin speeds to extract water from your load. You will hear a sound associated with these higher spin speeds. This sound is normal and will vary slightly as the spin speed varies with load size and cycle selected.

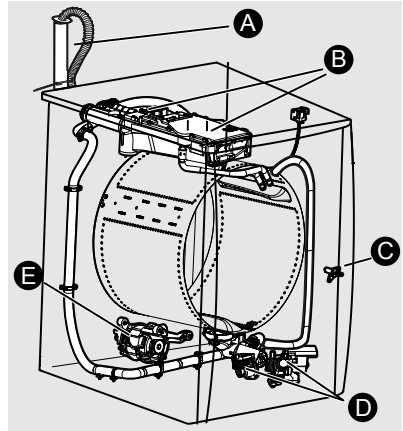

CAUTION

Abnormal, on-going sounds may be an indication of a pending washer failure and should be investigated by a qualified technician. Refer to *NOISE* section of the Troubleshooting section of this manual.

Stain removal procedures

To reduce the risk of fire or serious injury to persons or property, comply with the basic warnings listed below:

- Read and comply with all instructions on stain removal products.
- Keep stain removal products in their original labeled containers and out of children's reach.
- Thoroughly wash any utensils used.
- DO NOT combine stain removal products, especially ammonia and chlorine bleach. Dangerous fumes can result.
- Never wash items which have been previously cleaned in, washed in, soaked in or spotted with gasoline, dry cleaning solvents or other flammable or explosive substances because they give off vapors that could ignite or explode.
- Never use highly flammable solvents, such as gasoline, inside the home. Vapors can explode on contact with flames or sparks.

For successful stain removal:

- Remove stains promptly.
- Determine the kind of stain, then follow the recommended treatment in the stain removal chart on the next page.
- To pretreat stains, use a stain treatment product, liquid detergent, or a paste made from powder detergent and water.
- Use cold water on unknown stains as hot water can set stains.
- Consult care label instructions for treatments to avoid on specific fabrics.
- Check for colorfastness by testing stain remover products on an inside seam.
- Rinse and wash items after stain removal.



WARNING

HARMFUL VAPOR HAZARD

DO NOT use or mix liquid chlorine bleach with other household chemicals such as toilet cleaners, rust removers, acids such as vinegar, or products containing ammonia. These mixtures can produce dangerous fumes which can cause serious injury or death.



For best results

Follow the fabric care label instructions on items to be washed.



36 Stain Removal Guide

Stain removal suggestions

STAIN	TREATMENT
Adhesive tape, gum, rubber cement	Apply ice. Scrape off excess. Place stain down on paper towels. Saturate with prewash stain remover or nonflammable dry cleaning fluid.
Baby formula, dairy products, egg	Use product containing enzymes to pretreat or soak stains. Soak for 30 minutes or more. Wash.
Beverages (coffee, tea, soda, juice, alcoholic beverages)	Pretreat stain. Wash using cold water and bleach safe for fabric.
Blood	Rinse with cold water. Rub with bar soap. Or, pretreat or soak with product containing enzymes. Wash using bleach safe for fabric.
Candle wax, crayon	Scrape off surface wax. Place stain face down between paper towels. Press with warm iron until wax is absorbed. Replace paper towels frequently. Treat remaining stain with prewash stain remover or nonflammable dry cleaning fluid. Hand wash to remove solvent. Wash using bleach safe for fabric.
Chocolate	Pretreat or soak in warm water using product containing enzymes. Wash using bleach safe for fabric.
Collar or cuff soil, cosmetics	Pretreat with prewash stain remover or rub with bar soap.
Dye transfer on white fabric	Use packaged color remover. Wash using bleach safe for fabric.
Grass	Pretreat or soak in warm water using product containing enzymes. Wash using bleach safe for fabric.
Grease, oil, tar (butter, fats, salad dressing, cooking oils, car grease, motor oils)	Scrape residue from fabric. Pretreat. Wash using hottest water safe for fabric. For heavy stains and tar, apply nonflammable dry cleaning fluid to back of stain. Replace towels under stain frequently. Rinse thoroughly. Wash using hottest water safe for fabric.
Ink	Some inks may be impossible to remove. Washing may set some inks. Use prewash stain remover, denatured alcohol or nonflammable dry cleaning fluid.
Mildew, scorch	Wash with chlorine bleach if safe for fabric or soak in oxygen bleach and hot water before washing. Badly mildewed fabrics may be permanently damaged.
Mud	Brush off dry mud. Pretreat or soak with product containing enzymes.
Mustard, tomato	Pretreat with prewash stain remover. Wash using bleach safe for fabric.
Nail polish	May be impossible to remove. Place stain face down on paper towels. Apply nail polish remover to back of stain. Repeat, replacing paper towels frequently. DO NOT use on acetate fabrics.
Paint, varnish	WATER BASED: Rinse fabric in cool water while stain is wet. Wash. Once paint is dry, it can't be removed. OIL BASED AND VARNISH: Use solvent recommended on label. Rinse thoroughly before washing.
Perspiration	Use prewash stain remover or rub with bar soap. Rinse. Wash using non chlorine bleach in hottest water safe for fabric.
Rust, brown or yellow discoloration	Use rust remover safe for fabric. DO NOT use chlorine bleach because it may intensify discoloration.
Shoe polish	LIQUID: Pretreat with a paste of powder detergent and water. PASTE: Scrape residue from fabric. Pretreat with prewash stain remover or nonflammable dry cleaning fluid. Rinse. Rub detergent into dampened area. Wash using bleach safe for fabric.
Tomato	Pretreat with prewash stain remover. Wash using fabric safe bleach.
Urine, vomit, mucus, feces	Pretreat or soak in product containing enzymes. Wash using bleach safe for fabric.
Wine	Pretreat or soak in cold water. Wash in hottest water and bleach safe for fabric

Inside routine cleaning (preventative)

To help prevent odors or humidity accumulation leave the door open with the door stand ventilation feature (on select models) for a few hours after use or whenever the washer is not in use.



CAUTION

ENTRAPMENT and TIP-OVER HAZARD

DO NOT leave the door open if there are small children or pets present. An open door could entice children to hang on the door or crawl inside the washer. If there are no small children present, you may leave the door ajar to prevent odor build up.

To refresh or clean inside of washer

To clean and freshen the washer, perform the **clean washer** cycle. For best results perform the cycle once a month.



NOTE

Every 50 cycles, your washer will remind you to perform the clean washer cycle by illuminating the clean washer cycle indicator.

To begin the cycle, select the **clean washer** cycle. If installed, remove the **LIQUID DETERGENT** cup from the dispenser. **REMOVE ALL ITEMS FROM WASH DRUM** before filling the detergent compartment with one (1) cup of liquid chlorine bleach OR one (1) pouch of Tide™ Washing Machine Cleaner. DO NOT use both. Press **start/pause** to begin.



IMPORTANT

Items left in washer while performing the **clean washer** cycle will cause a severe out-of-balance situation that could damage the washing machine.



For best results

Immediately follow up with a **rinse & spin** cycle. Select **max spin** with no detergent or bleach to help clear any residual bleach left after the **clean washer** cycle.



WARNING

HARMFUL VAPOR HAZARD

DO NOT use or mix liquid chlorine bleach with other household chemicals such as toilet cleaners, rust removers, acid or products containing ammonia. These mixtures can produce dangerous fumes which can cause serious injury or death.



To Clean the dispenser drawer



NOTE

Detergent and fabric softener may build up in the dispenser drawer. Residue should be removed once or twice a month.

Cleaning the three compartment dispenser

1. Remove the drawer by pulling the drawer out until it stops.
2. Reach back into the left rear corner of the drawer cavity and press down firmly on the lock tab. Pull out the drawer.

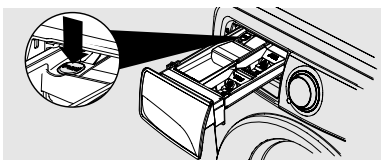

3. Remove all inserts from the drawers.

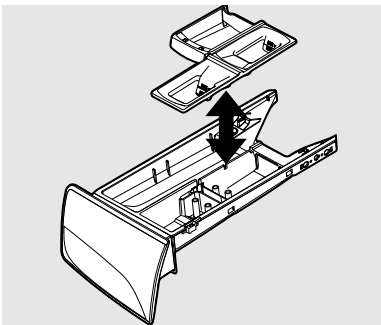

38 Care and Cleaning

4. Rinse the drawer and inserts with hot tap water to remove traces of accumulated powders and liquids. Large amounts of fabric softener residue may indicate improper dilution or more frequent cleaning is required.
5. To clean the drawer opening, use a small brush to clean the recess. Remove all residue from the upper and lower parts of the recess.

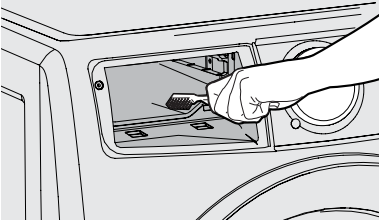

6. Replace the insert by pressing it in place until you hear a slight click.
7. Return the dispenser drawer to the unit.

Cleaning the Adaptive Dispenser™

1. Remove the drawer by pulling the dispenser out until it stops.
2. Reach back into the right rear corner of the dispenser cavity and press down firmly on the lock tab. Pull out the dispenser drawer.

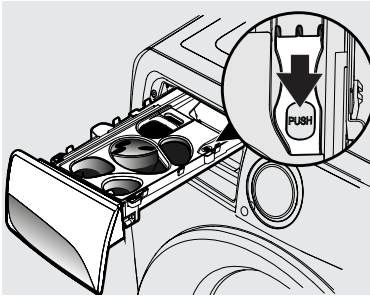

3. Remove the detergent cup and top cover from the dispenser drawer.
4. Remove the bottom cover from the dispenser drawer.
 - a) First, pull the two lock tabs at the rear of the dispenser drawer to unlatch the back cover.
 - b) Then, gently pull back the two clips on the front of the bottom cover to fully release it from the dispenser drawer.

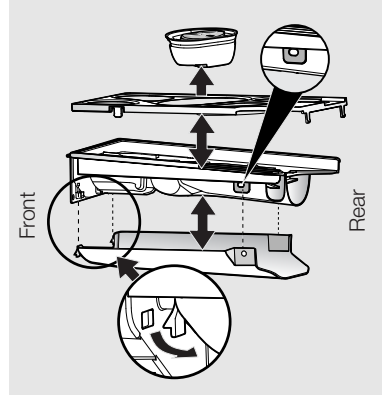

5. Rinse the dispenser drawer, covers, and detergent cup with hot tap water to remove traces of accumulated powders and liquids. Large amounts of fabric softener residue may indicate improper dilution or more frequent cleaning is required.
6. To clean the dispenser drawer opening, use a small brush to clean the recess. Remove all residue from the upper and lower parts of the recess.
7. Reassemble dispenser drawer and check to ensure that all pieces are securely in place.
8. Return the dispenser drawer to the unit.

Inside cleaning (aggressive)

In cases where **clean washer** cycle along with care and cleaning of rubber gasket folds isn't done, and severe odor or residue buildup have developed, follow the below cleaning procedure to help alleviate the problem.

Cleaning procedure-washer drum

Ensure the wash tub is empty. Open the detergent drawer and pour eight cups of bleach into the **Main Wash** detergent compartment. Select clean washer cycle as described previously in Inside Routine Cleaning (Preventative).

Upon cycle completion inspect the interior of the washer to see if the odor/residue has been eliminated. If any additional cleaning is required, repeat the above procedure. This may take several cycles depending on the severity of the odor/residue. You may observe some remaining discoloration due to the long term effects of this residue.

For especially contaminated areas visible inside the drum (including the front rubber seal), these areas might be more effectively cleaned by spraying a bleach cleaner on a scrub brush, soft sponge, or towel and scrubbing.



IMPORTANT

Always wear rubber or latex gloves and protect floor and clothing from damage.

If odor is still left after bleach cycle(s) and bleach cleaner, open the detergent drawer and pour one (1) pouch of Tide™ Washing Machine Cleaner in detergent drawer. Select clean washer cycle as above and start the washer.



For best results

Immediately follow up with a **rinse & spin** cycle. Select **max spin** with no detergent or bleach to help clear any residual bleach left after the **clean washer** cycle.



IMPORTANT

See *Inside Routine Cleaning* for future cleaning maintenance which is necessary to avoid repeating issues.

Three Compartment Preventative Cleaning

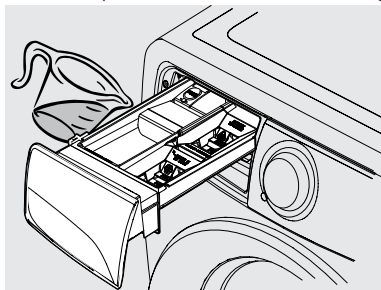

Adaptive Dispenser™
Preventative Cleaning

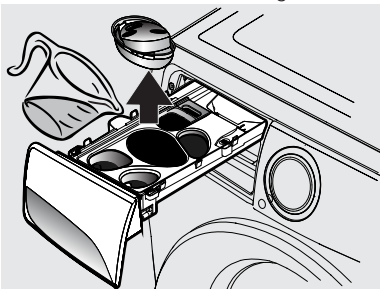

WARNING

HARMFUL VAPOR HAZARD

DO NOT use or mix liquid chlorine bleach with other household chemicals such as toilet cleaners, rust removers, acid or products containing ammonia. These mixtures can produce dangerous fumes which can cause serious injury or death.



40 Care and Cleaning

Outside routine cleaning

- When washing is completed, wipe top and sides of washer with a damp cloth.
- Clean the cabinet with mild soap and water. Never use harsh, gritty or abrasive cleansers
- If the cabinet becomes stained, clean with diluted chlorine bleach (1 part bleach to 8 parts water). Rinse several times with clear water.
- Remove glue residue from tape or labels with a mixture of warm water and mild detergent. Or, touch residue with the sticky side of tape.
- When cleaning chrome parts, it is best to use only a damp cloth.
- Before moving the washer, place a strip of cardboard or thin fiberboard under the front leveling legs to prevent damage to the floor.



IMPORTANT

DO NOT store or place laundry products on top of washer at any time. They can damage the finish or controls. It is recommended to keep laundry products in the storage drawer between cycles if installed on a pedestal.

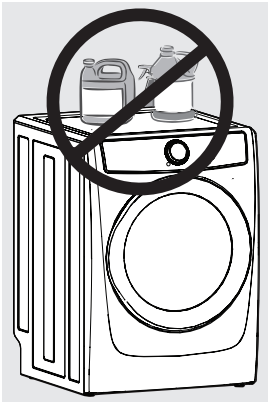

Winterizing instructions

1. Turn off water supply faucets.
2. Disconnect hoses from water supply and drain water from hoses. Vacuum out each water supply inlet with a waterproof utility vac to ensure water valves are completely drained. Damage will occur if water in water inlet valves are allowed to freeze.
3. Plug electrical cord into a properly grounded electrical outlet.
4. Add 1 gallon (3.8 L) nontoxic recreational vehicle (RV) antifreeze to empty wash drum. Close door.
5. Select any cycle. Press **start/pause** and let the washer drain for 1 minute to drain out all the water. Not all of the RV antifreeze will be expelled.
6. Press **cancel**, unplug electrical power cord, dry off drum interior and close door.
7. Remove dispenser drawer. Drain any water in compartments and dry compartments. Replace drawer.
8. Store washer in an upright position.
9. To remove antifreeze from washer after storage, run empty washer through a complete cycle using detergent. DO NOT add wash load.



IMPORTANT

If the washer is stored in an area where freezing can occur or moved in freezing temperatures, follow these winterizing instructions to prevent damage to the washer:



Follow WINTERIZING INSTRUCTIONS for cold weather storage and care.

Water inlet hose inspection

Periodically inspect all water inlet hoses for water leaks, wear, cuts, corrosion and bulges. Replace all hoses, if any sign of the above is visible. All hoses should be replaced every 5 years to reduce the risk of hose failures. When replacing hoses, refer to the Installation sections of this Use & Care guide for proper installation instructions. DO NOT overtighten or cross thread the fittings. DO NOT allow the hose to rub against sharp objects. Always ensure the hose fitting rubber gasket is installed and free from water leaks when water pressure is applied.

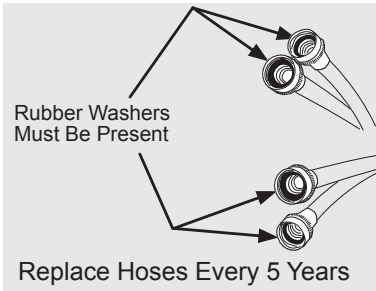

Instructions for limited use, vacation and away from home



CAUTION

Your washer should be operated **ONLY** when you are home. Water leakage is a safety issue and can cause personal injury or property damage. If you are away from home or not using your washer for extended periods of time, follow these steps:

1. Turn off the water supply to washer to avoid water leaks due to water pressure surges and unforeseen occurrences in the water supply.
2. Disconnect or unplug the electrical power to the washer.
3. Remove excess water from the dispenser, interior door and tub and perform the Care and Cleaning steps.

Reconnecting water supply and electrical



IMPORTANT

When reinstalling the washer after disconnecting the water supply lines and electrical power, please follow the steps below:

1. Review the *Installation* section of this guide to ensure the appliance is level and the water and electrical power supply is properly connected.
2. Ensure the water lines are flushed of debris, prior to connecting the water lines to the washer inlet.
3. Check for water leaks and replace supply hoses if needed.



CAUTION

Damaged or improperly installed water lines can cause the water lines or connections to leak. Water leakage is a safety issue and can cause personal injury or property damage.



WARNING

Improper grounding of the washer may cause serious injury or death. Check with a licensed electrician if you are in doubt as to whether the appliance is properly grounded.

Grounding type wall receptacle

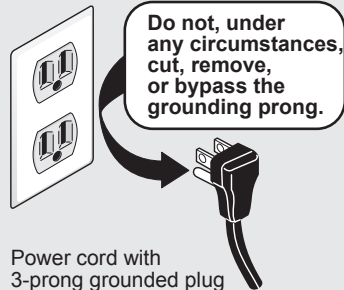

42 Troubleshooting

Common washing inquiries

Many washing problems involve poor soil and stain removal, residues of lint and scum, and fabric damage. For satisfactory washing results, follow these suggestions provided by The Soap and Detergent Association.

PROBLEM	POSSIBLE CAUSES	SOLUTIONS	PREVENTIVE MEASURES
Blue stains	<ul style="list-style-type: none">• Undiluted liquid detergent or fabric softener dispensed directly onto fabric.	<ul style="list-style-type: none">• If caused by detergent, mix 1 cup (240 ml) white vinegar with 1 qt (.95 L) water in plastic container. Soak 1 hour. Rinse.• If caused by fabric softener, rub stains with bar soap. Wash.	<ul style="list-style-type: none">• Avoid overfilling detergent and fabric softener compartments of dispenser.
Discoloration, graying	<ul style="list-style-type: none">• Not enough detergent.• Wash water temperature too low.• Incorrect sorting.	<ul style="list-style-type: none">• Rewash with correct amount of detergent and hottest water safe for fabric.• Add bleach safe for fabric.	<ul style="list-style-type: none">• Sort items by soil level and color.• Use correct amount of detergent, hottest water and bleach safe for fabric.
Greasy, oily stains	<ul style="list-style-type: none">• Not enough detergent.• Undiluted liquid fabric softener poured directly on fabric.	<ul style="list-style-type: none">• Treat with prewash stain remover or liquid detergent.• Increase detergent and water temperature. Rewash.• Rub fabric softener stains with bar soap.	<ul style="list-style-type: none">• Use correct amount of detergent and hottest water safe for fabric.• DO NOT pour liquid fabric softener directly on fabric.
Holes, tears, or snags	<ul style="list-style-type: none">• Incorrect use of chlorine bleach.• Unfastened zippers, hooks, buckles.• Rips, tears and broken threads.• Overloading washer.• Degradation of fabric.	<ul style="list-style-type: none">• May be irreversible if rips, tears and seams cannot be mended.	<ul style="list-style-type: none">• Never pour chlorine bleach directly on fabric.• Check condition of items before washing.
Lint	<ul style="list-style-type: none">• Incorrect sorting.• Tissues left in pocket.• Overloading washer.• Not enough detergent.• Undissolved detergent has left a residue resembling lint.• Static cling is attracting lint.• Load washed too long.	<ul style="list-style-type: none">• Reduce load size. Rewash using correct water temperature, water level, and amount of detergent.• Add nonprecipitating water conditioner to wash water to remove detergent residue.• Add liquid fabric softener to final rinse.• Dry load in dryer.• Remove lint with lint brush or roller.	<ul style="list-style-type: none">• See <i>Operating Your Washer</i>.• DO NOT overload washer.• Use correct temperature and amount of detergent, water and wash time.

PROBLEM	POSSIBLE CAUSES	SOLUTIONS	PREVENTIVE MEASURES
Pilling (Fibers ball up and cling to fabric.)	<ul style="list-style-type: none"> • Pilling is normal with synthetic and permanent press fabrics. This is due to abrasion from normal wear. 	<ul style="list-style-type: none"> • Use a lint brush or shaver to remove pills. 	<ul style="list-style-type: none"> • Use fabric softener in washer to lubricate fibers. • When ironing, use spray starch or fabric finish on collars and cuffs. • Turn items inside out to reduce abrasion.
Residue or powder on dark items; Stiff, harsh fabrics.	<ul style="list-style-type: none"> • Undissolved detergent. • Some granular detergents can combine with hard water minerals to form a residue. • Overloading washer. 	<ul style="list-style-type: none"> • Rewash load. 	<ul style="list-style-type: none"> • Increase water temperature using hottest water safe for fabric. • DO NOT overload washer. • Use liquid detergent or nonprecipitating water conditioner with powder detergent.
Wrinkling	<ul style="list-style-type: none"> • Overloading washer. • Incorrect wash cycle for wash load. 	<ul style="list-style-type: none"> • Reduce load size. • Rinse in cold water with liquid fabric softener using the casual or delicate cycle. 	<ul style="list-style-type: none"> • DO NOT overload washer. • Remove items from washer as soon as cycle is completed. • Use liquid fabric softener.
Yellow buildup of body soil on synthetic fabrics	<ul style="list-style-type: none"> • Agitation time too short. • Wash water temperature too low. • Not enough detergent. 	<ul style="list-style-type: none"> • Soak in detergent booster or product containing enzymes. • Wash in hottest water safe for fabric using casual cycle. • Increase detergent. • Add bleach safe for fabric or treat with color remover. 	<ul style="list-style-type: none"> • Select correct cycle. • Use correct amount of detergent. • Wash synthetics frequently using hot or warm water.
Yellow or brown rust stains	<ul style="list-style-type: none"> • Iron or manganese in water supply, water pipes, or water heater. 	<ul style="list-style-type: none"> • To restore discolored load of whites, use rust remover safe for fabric. • DO NOT use chlorine bleach to remove rust stains. It may intensify discoloration. 	<ul style="list-style-type: none"> • Use nonprecipitating water softener. • Before washing, run hot water for a few minutes to clear lines. • Drain water heater occasionally. • For an ongoing problem, install an iron filter in your water supply system.

44 Troubleshooting

PROBLEM	POSSIBLE CAUSES	SOLUTIONS	PREVENTIVE MEASURES
Residue stain buildup in gasket	<ul style="list-style-type: none"> • Moisture in washer. • Use of non-HE detergent. • Overdosing detergent. • Overloading wash drum. • Leaving a wet load set in washer. • Cold water washes which may not completely dissolve and remove detergents. 	<ul style="list-style-type: none"> • Perform clean washer cycle • Scrub gasket with Comet™ Spray Gel Mildew Stain Remover - use brush to remove stains. • Use only HE (high efficiency detergent) along with recommended dosage. • Remove wash load immediately upon cycle completion. 	<ul style="list-style-type: none"> • Run dehumidifier in laundry room. • Avoid overfilling detergent and fabric softener compartments of dispenser. • Dry the inside of washer and gasket after every run.
Residue stain buildup in dispenser drawer or detergent pack not dissolved.	<ul style="list-style-type: none"> • Moisture in the washer. • Use of non-HE detergent. • Overdosing detergent. • Adding more than two detergent packs to detergent pack compartment. • PODS® option not selected when using detergent pack (on select models). 	<ul style="list-style-type: none"> • Remove and clean dispenser and inserts with combination of ¼ cup liquid chlorine bleach and one gallon hot water. Rinse well, and repeat if necessary. NOTE: Wear rubber of latex gloves. Protect floor and clothing from bleach damage. • Use only HE (high efficiency detergent) along with recommended dosage. 	<ul style="list-style-type: none"> • Avoid overfilling detergent and fabric softener compartments of dispenser. • Check that PODS® option is selected and detergent pack is placed in PODS® dispenser compartment when using detergent pack (on select models).
Water in fold of flexible gasket	<ul style="list-style-type: none"> • Result of washing and part of normal operation. 	<ul style="list-style-type: none"> • At the end of each wash, dry inside of gasket fold with clean dry towel all around gasket. 	
Odor	<ul style="list-style-type: none"> • Moisture in the washer. • Use of non-HE detergent. • Overdosing detergent. • Leaving a wet load remain in washer. • Cold water washes which may not completely dissolve and remove detergents. 	<ul style="list-style-type: none"> • Perform clean washer cycle. • At the end of each wash, dry inside of gasket fold with clean, dry towel all around gasket. • Use only HE (high efficiency detergent) along with recommended dosage. • Remove wash load immediately upon cycle completion. • Pour one cup liquid chlorine bleach in standpipe; let remain a day and flush with water. 	<ul style="list-style-type: none"> • Utilize the door stand ventilation feature for a few hours after use or whenever washer is not in use.

Before calling

Before calling for service, review this list. It may save both time and expense. The list includes common occurrences that are not the result of defective workmanship or materials in this washer.

PROBLEM	POSSIBLE CAUSES	SOLUTIONS
NOISE (Please refer to <i>Normal Operating Sounds</i>)		
High pitch "jet engine" noise	<ul style="list-style-type: none"> A certain amount of motor whine is normal during the spin cycle. 	
Rattling and clanking noise	<ul style="list-style-type: none"> Foreign objects such as coins or safety pins may be in drum or pump. Belt buckles and metal fasteners are hitting wash drum. 	<ul style="list-style-type: none"> Stop washer and check drum. If no objects are found, perform cycle with empty drum. If noise continues, item may be in pump. Call your authorized service technician. To prevent unnecessary noise and damage to drum, fasten fasteners and turn items inside out.
Thumping sound	<ul style="list-style-type: none"> Heavy wash loads may produce a thumping sound. This is usually normal. If sound continues, washer is probably out of balance. 	<ul style="list-style-type: none"> Stop washer and redistribute wash load.
Vibrating noise	<ul style="list-style-type: none"> Washer is not resting firmly on floor. Shipping bolts and foam block have not been removed during installation. Wash load unevenly distributed in drum. 	<ul style="list-style-type: none"> Move washer so it rests firmly on floor. Adjust leveling legs. See <i>Leveling the washer</i> for details. See Installation sections of this guide for removing shipping bolts and foam block. Stop washer and rearrange wash load.
OPERATING		
Residue left in drum	<ul style="list-style-type: none"> Heavily soiled items. 	<ul style="list-style-type: none"> Wipe drum with a nonabrasive household cleanser, then rinse. Shake or brush excess dirt and sand from items before washing.
LED displays "drn"	<ul style="list-style-type: none"> Washer has been programmed to temporarily perform a repeating demo cycle. 	<ul style="list-style-type: none"> Reset the unit back to factory default settings. <ol style="list-style-type: none"> Press power to turn off unit. Press power again to turn unit on. Look for console to light up. Wait at least 10 seconds, then simultaneously press and hold soil and options buttons for 3 secs. Lights will turn OFF and ON, indicating the unit has been reset to factory default
Washer won't spin	<ul style="list-style-type: none"> Load is too small. 	<ul style="list-style-type: none"> Add 1 or 2 similar items to help balance the load.
LED Displays "CLEAR door"	<ul style="list-style-type: none"> Washer has detected something trapped between the door and door gasket. 	<ul style="list-style-type: none"> Press the cancel button to unlock the door, remove the trapped item, close the door and restart the cycle.

46 Troubleshooting

PROBLEM	POSSIBLE CAUSES	SOLUTIONS
Washer does not start	<ul style="list-style-type: none"> • Electrical power cord may not be plugged in or connection may be loose. • House fuse blown, circuit breaker tripped, or a power outage has occurred. • Action of pressing start/pause button on “touch screen” style console not recognized. • Water supply faucets are not turned on. • Motor is overheated. Washer motor will stop if overheated. • Door may be open. Unit will not operate with door open. • Light next to start/pause button is flashing indicating unit is paused. 	<ul style="list-style-type: none"> • Make sure plug fits tightly in wall outlet. • Reset circuit breaker or replace fuse. DO NOT increase fuse capacity. If problem is a circuit overload, have it corrected by a qualified electrician. If problem is a power outage, call local electric company. • Press start/pause button with bare fingertip. • Turn on water supply faucets. • It will automatically restart after a cool down period of up to 30 minutes (if washer has not been manually turned off). • Ensure door is closed. • Press start/pause button to continue the cycle.
WATER		
Water collects in folds of the door gasket at the end of the cycle	<ul style="list-style-type: none"> • This is a result of the washing action and is part of the normal operation of the washer. 	<ul style="list-style-type: none"> • Wipe and dry the gasket to remove water and any debris remaining in the gasket after use.
Water collects in bleach and fabric softener compartments	<ul style="list-style-type: none"> • This is a result of the siphoning action and is part of the normal operation of the washer. 	<ul style="list-style-type: none"> • Water may be removed by removing the dispenser drawer (see <i>Care and Cleaning</i> in this guide) and draining water into the empty drum or sink.
Wash load too wet after spin	<ul style="list-style-type: none"> • Washer is overloaded. • Load is too small. • Load is out of balance. • Drain hose is kinked. 	<ul style="list-style-type: none"> • DO NOT overload washer. See <i>Operating Your Washer</i>. • Add 1 or 2 similar items to help balance load. • Rearrange load to allow proper spinning. • Straighten drain hose.
Water does not enter washer or it enters slowly	<ul style="list-style-type: none"> • Water supply is not adequate in area. • Water supply faucets are not completely open. • Water is being used elsewhere in the house. Water pressure must be at least 30 psi (260 kPa). • Water inlet hoses are kinked. • Water inlet screens plugged. 	<ul style="list-style-type: none"> • Check another faucet in the house. Wait until water supply and pressure increase. • Fully open hot and cold faucets. • Avoid running water elsewhere while washer is filling. • Straighten hoses. • Remove hose from inlets and clean screens.

PROBLEM	POSSIBLE CAUSES	SOLUTIONS
Warm or hot water is not hot enough	<ul style="list-style-type: none"> Hot water heater is set too low or is a distance from washer. Hot water is being used elsewhere in the house. 	<ul style="list-style-type: none"> Measure hot water temperature at nearby faucet with candy or meat thermometer. Water temperature should be at least 120°F (49°C). Adjust water heater as necessary. Avoid using hot water elsewhere before or during washer use. There may not be enough hot water available for proper cleaning. If problem persists, your hot water system may be unable to support more than 1 use at a time.
Water in washer does not drain or drains slowly	<ul style="list-style-type: none"> Drain hose is kinked or clogged. Drain hose standpipe is too tall. Maximum standpipe height is 8' (2.4 m). House drain pipes are clogged. 	<ul style="list-style-type: none"> Clean and straighten the drain hose. Reduce standpipe height to less than 8' (2.4 m). See Installation sections of this guide. Unclog drain pipes. Contact plumber if necessary.
Water leaks	<ul style="list-style-type: none"> Fill hose connection is loose at faucet or washer. Dispenser drawer not completely closed Water hoses have damage, cuts or corrosion. 	<ul style="list-style-type: none"> Check and tighten hose connections. Install rubber sealing washers provided. Close dispenser drawer completely. Replace hoses.
Oversudsing	<ul style="list-style-type: none"> HE detergent is not being used. Too much detergent. 	<ul style="list-style-type: none"> Run rinse cycle. Use a low-sudsing, high efficiency detergent. Run rinse cycle. Use less detergent in future loads.
Incorrect wash and rinse temperatures. The LED display will alert this condition with "HOSE" alarm	<ul style="list-style-type: none"> Hot and cold water hoses are connected to wrong supply faucets. 	<ul style="list-style-type: none"> Connect hot water hose to hot water faucet and cold water hose to cold water faucet.
Water is entering washer but tub does not fill	<ul style="list-style-type: none"> Drain hose standpipe is too low. Standpipe must be a min of 23.6" (60 cm) high to prevent siphoning. 	<ul style="list-style-type: none"> Increase standpipe height to at least 23.6" (60 cm). See Installation sections of this guide.

48 Limited Warranty

For the applicable warranty period as set forth below, as measured from your original date of purchase, Electrolux will repair or replace any parts of this appliance that prove to be defective in materials or workmanship when such appliance is installed, used and maintained in accordance with the provided instructions.

Warranty Periods:

- All parts — One year including labor. In addition, your appliance is covered by a one year, parts only, limited warranty. During the 2nd year from your original date of purchase, Electrolux will pay for parts needed for this appliance that have proven to be defective in materials or workmanship when your appliance is installed, used, and maintained in accordance with the provided instructions.
- Inner wash tub (washer) — Functional life of the product (excluding labor)
- Wash tub drive motor (washer), non-cosmetic defects — Ten years (excluding labor)

Exclusions

This warranty does not cover the following:

1. Products with original serial numbers that have been removed, altered or cannot be readily determined.
2. Product that has been transferred from its original owner to another party or removed outside the USA or Canada.
3. Rust on the interior or exterior of the unit.
4. Products purchased "as-is" are not covered by this warranty.
5. Products used in a commercial setting.
6. Service calls which DO NOT involve malfunction or defects in materials or workmanship, or for appliances not in ordinary household use or used other than in accordance with the provided instructions.
7. Service calls to correct the installation of your appliance or to instruct you how to use your appliance.
8. Expenses for making the appliance accessible for servicing, such as removal of trim, cupboards, shelves, etc., which are not a part of the appliance when it is shipped from the factory.
9. Service calls to repair or replace appliance light bulbs, air filters, water filters, other consumables, or knobs, handles, or other cosmetic parts.
10. Pickup and delivery costs; your appliance is designed to be repaired in the home.
11. Surcharges including, but not limited to, any after hour, weekend, or holiday service calls, tolls, ferry trip charges, or mileage expense for service calls to remote areas, including the state of Alaska.
12. Damages to the finish of appliance or home incurred during transportation or installation, including but not limited to floors, cabinets, walls, etc.
13. Damages caused by: services performed by unauthorized service companies; use of parts other than genuine Electrolux parts or parts obtained from persons other than authorized service companies; or external causes such as abuse, misuse, inadequate power supply, accidents, fires, or acts of God.

DISCLAIMER OF IMPLIED WARRANTIES; LIMITATION OF REMEDIES

CUSTOMER'S SOLE AND EXCLUSIVE REMEDY UNDER THIS LIMITED WARRANTY SHALL BE REPAIR OR REPLACEMENT AS PROVIDED HEREIN. **CLAIMS BASED ON IMPLIED WARRANTIES, INCLUDING WARRANTIES OF MERCHANTABILITY OR FITNESS FOR A PARTICULAR PURPOSE, ARE LIMITED TO ONE YEAR OR THE SHORTEST PERIOD ALLOWED BY LAW, BUT NOT LESS THAN ONE YEAR.** ELECTROLUX SHALL NOT BE LIABLE FOR CONSEQUENTIAL OR INCIDENTAL DAMAGES SUCH AS PROPERTY DAMAGE AND INCIDENTAL EXPENSES RESULTING FROM ANY BREACH OF THIS WRITTEN LIMITED WARRANTY OR ANY IMPLIED WARRANTY. SOME STATES AND PROVINCES DO NOT ALLOW THE EXCLUSION OR LIMITATION OF INCIDENTAL OR CONSEQUENTIAL DAMAGES, OR LIMITATIONS ON THE DURATION OF IMPLIED WARRANTIES, SO THESE LIMITATIONS OR EXCLUSIONS MAY NOT APPLY TO YOU. THIS WRITTEN WARRANTY GIVES YOU SPECIFIC LEGAL RIGHTS. YOU MAY ALSO HAVE OTHER RIGHTS THAT VARY FROM STATE TO STATE.

If You Need Service

Keep your receipt, delivery slip, or some other appropriate payment record to establish the warranty period should service be required. If service is performed, it is in your best interest to obtain and keep all receipts. Service under this warranty must be obtained by contacting Electrolux at the addresses or phone numbers below.

This warranty only applies in the USA, Puerto Rico and Canada. In the USA and Puerto Rico, your appliance is warranted by Electrolux Major Appliances North America, a division of Electrolux Home Products, Inc. In Canada, your appliance is warranted by Electrolux Canada Corp. Electrolux authorizes no person to change or add to any obligations under this warranty. Obligations for service and parts under this warranty must be performed by Electrolux or an authorized service company. Product features or specifications as described or illustrated are subject to change without notice.

USA

1-877-435-3287

Electrolux Home Products, Inc.,
North America
10200 David Taylor Drive
Charlotte, NC 28262



Electrolux

Canada

1-800-265-8352

Electrolux Canada Corp.
5855 Terry Fox Way
Mississauga, Ontario, Canada
L5V 3E4

electrolux.com/shop

